



US00D752760S

(12) **United States Design Patent**  
**Raad**

(10) **Patent No.:** **US D752,760 S**  
(45) **Date of Patent:** **\*\* Mar. 29, 2016**

- (54) **ORAL SLEEP APPLIANCE**
- (71) Applicant: **Respire Medical Holdings, LLC**,  
Brooklyn, NY (US)
- (72) Inventor: **Walid Raad**, Brooklyn, NY (US)
- (73) Assignee: **Respire Medical Holdings, LLC**,  
Brooklyn, NY (US)
- (\*\*) Term: **14 Years**
- (21) Appl. No.: **29/517,248**
- (22) Filed: **Feb. 11, 2015**
- (51) **LOC (10) Cl.** ..... **24-99**
- (52) **U.S. Cl.**  
USPC ..... **D24/180**
- (58) **Field of Classification Search**  
USPC ..... D24/176-182; D29/108; 128/848, 859,  
128/861; 602/902; 433/6-7, 18-19, 24,  
433/137, 44  
CPC ..... A61C 7/00; A61C 7/08; A61C 7/10;  
A61C 7/36; A61F 5/566; A61F 5/56  
See application file for complete search history.

- 8,205,617 B2 \* 6/2012 Scarberry ..... A61F 5/566  
128/846
- 8,662,084 B2 \* 3/2014 Thornton ..... A61C 7/08  
128/859
- D719,266 S \* 12/2014 Goldstein ..... D24/180
- 9,144,512 B2 \* 9/2015 Wagner ..... A61F 5/566
- 2012/0216820 A1 \* 8/2012 Scarberry ..... A61F 5/566  
128/848

\* cited by examiner

*Primary Examiner* — Wan Laymon

(74) *Attorney, Agent, or Firm* — Ralph D. Chabot

(57) **CLAIM**

The ornamental design for an oral sleep appliance, as shown and described.

**DESCRIPTION**

FIG. 1 is a top, front, left side perspective view of an oral sleep appliance showing my new design;  
 FIG. 2 is a front elevation thereof;  
 FIG. 3 is a rear elevation thereof;  
 FIG. 4 is a right side elevation thereof with the left side being a mirror image;  
 FIG. 5 is a top plan view thereof;  
 FIG. 6 is a bottom plan view thereof;  
 FIG. 7 is a cross-section view taken in the direction of line 7-7 of FIG. 2, shown at an enlarged scale;  
 FIG. 8 is a cross-section view taken in the direction of line 8-8 of FIG. 2, shown at an enlarged scale;  
 FIG. 9 is a cross-section view taken in the direction of line 9-9 of FIG. 2, shown at an enlarged scale;  
 FIG. 10 is a right side elevation view of a first alternative position; and,  
 FIG. 11 is a right side elevation view of a second alternative position.

**1 Claim, 5 Drawing Sheets**

- (56) **References Cited**  
U.S. PATENT DOCUMENTS
- 5,868,138 A \* 2/1999 Halstrom ..... A61F 5/566  
128/848
- 6,516,805 B1 \* 2/2003 Thornton ..... A61F 5/566  
128/848
- 6,857,429 B2 \* 2/2005 Eubank ..... A61C 7/08  
128/848
- 7,520,281 B1 \* 4/2009 Nahabedian ..... A61F 5/566  
128/848
- 7,832,402 B2 \* 11/2010 Nelissen ..... A61F 5/566  
128/848

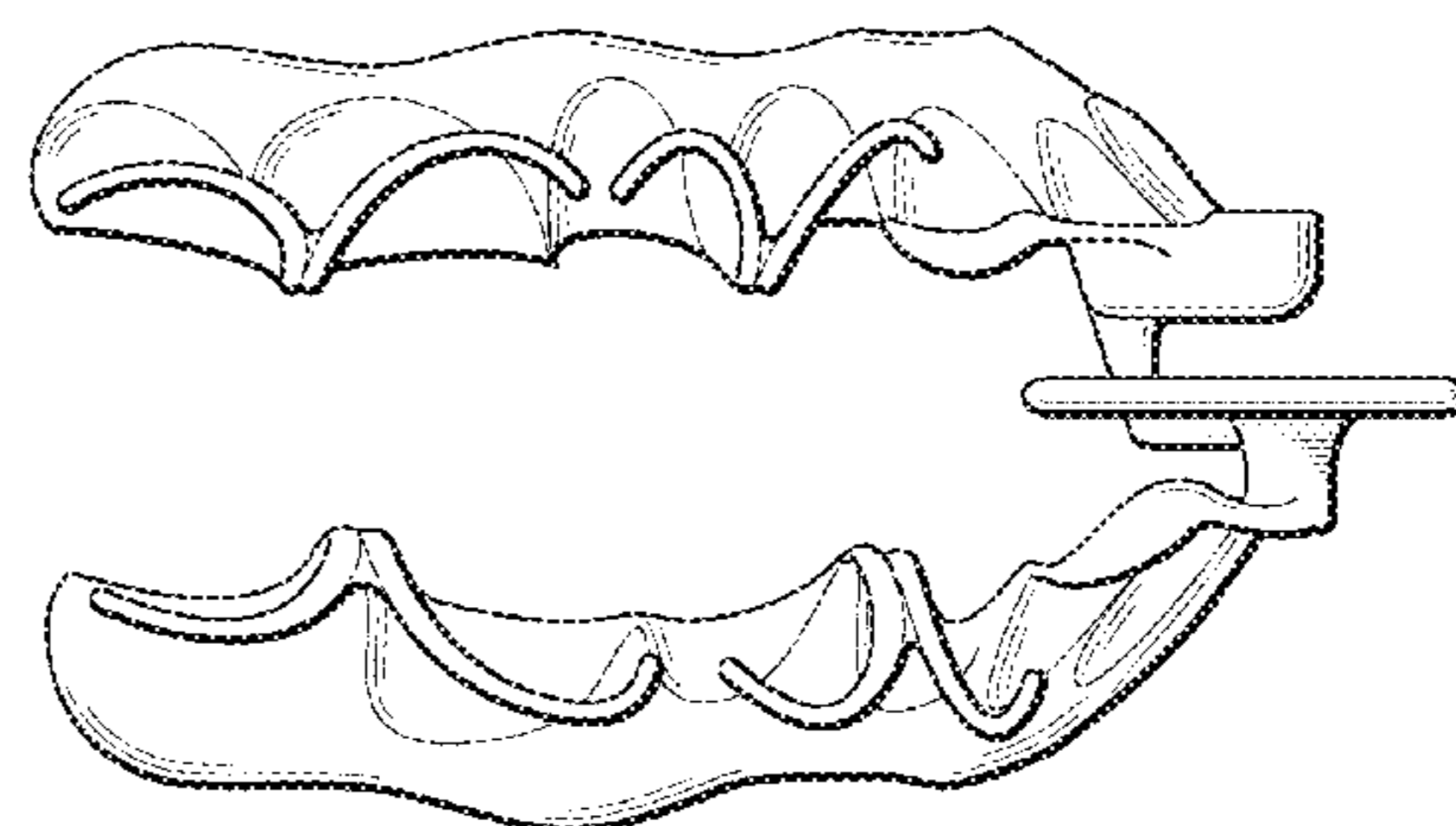
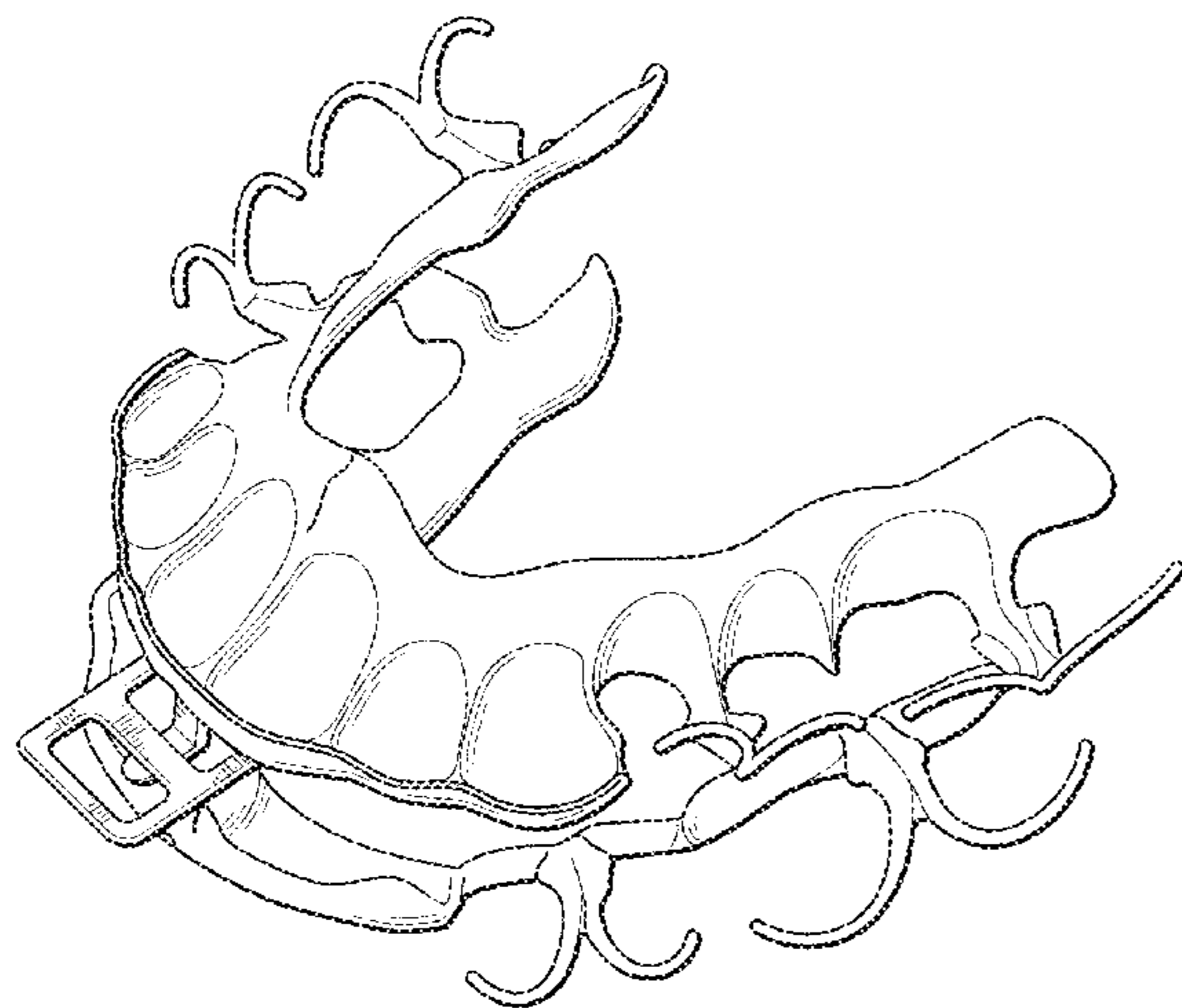

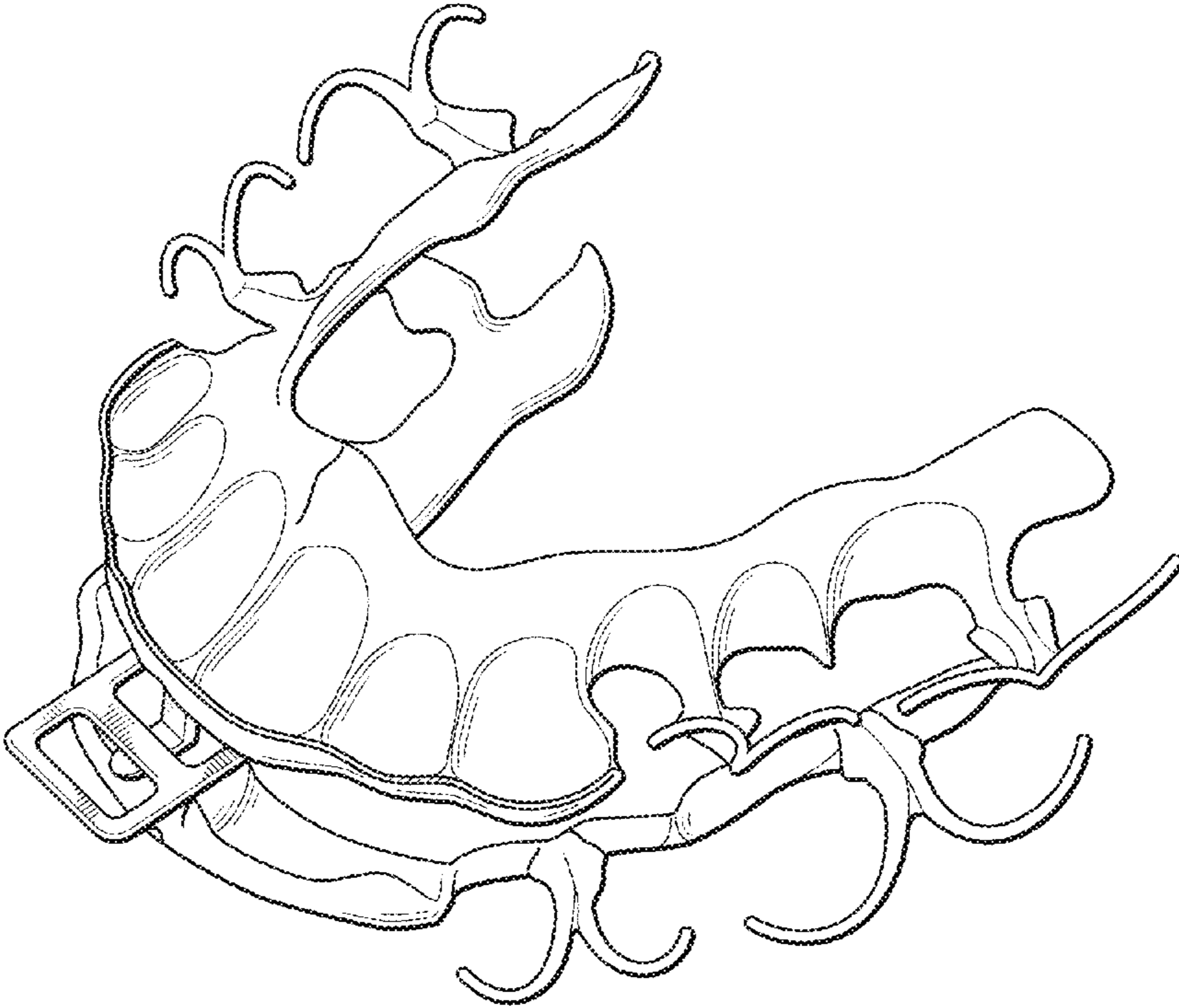
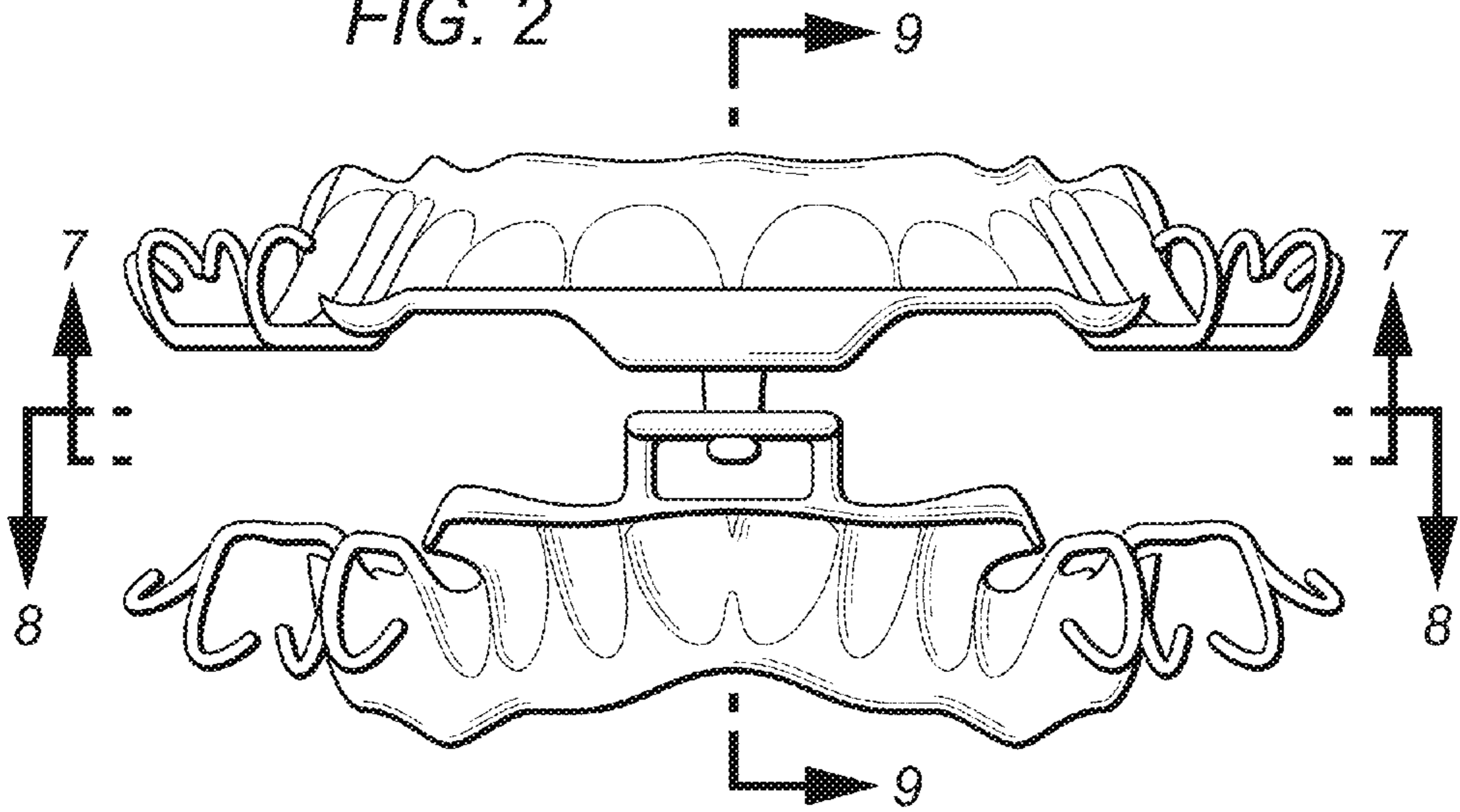

FIG. 1

FIG. 2



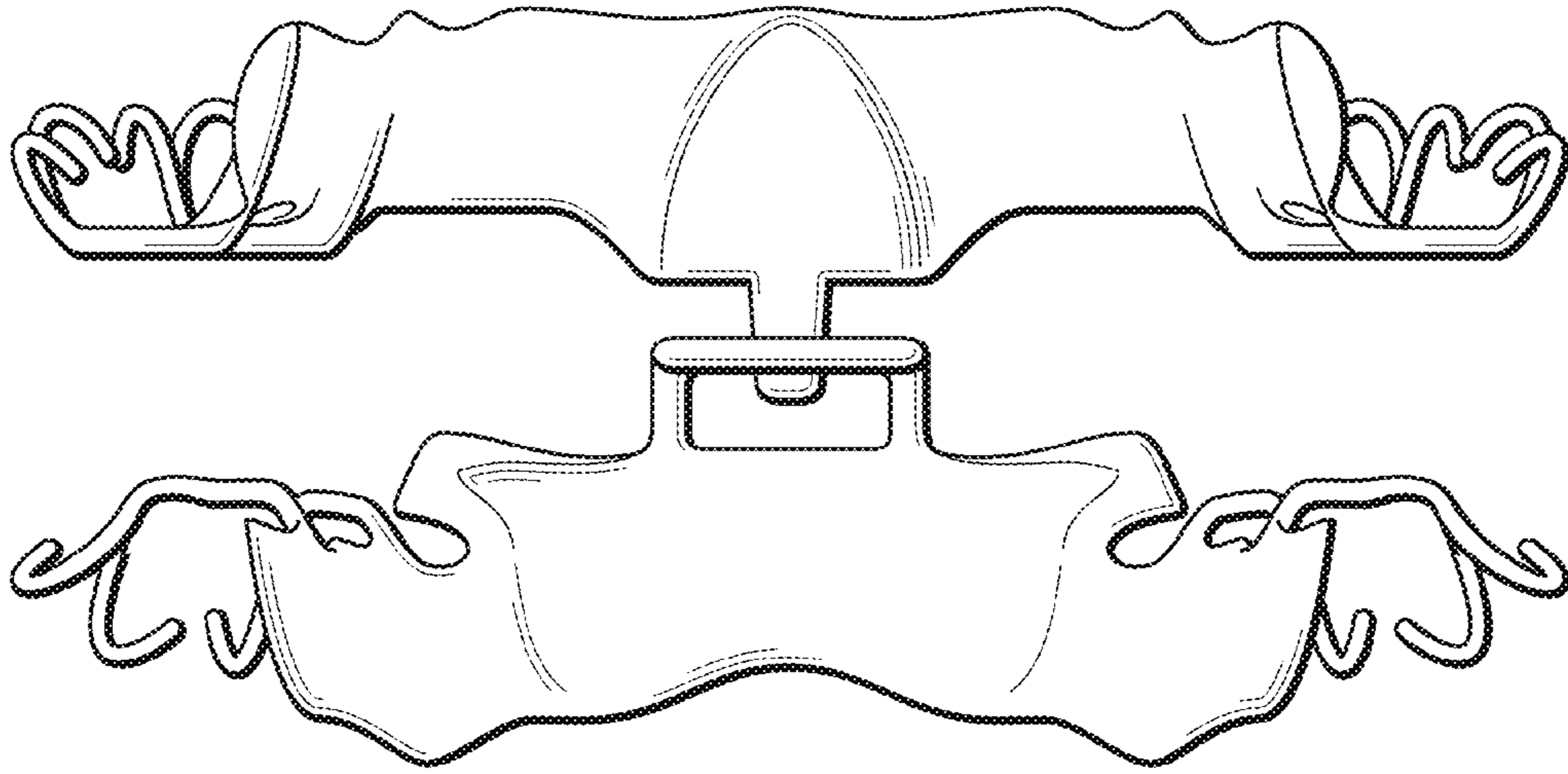

FIG. 3

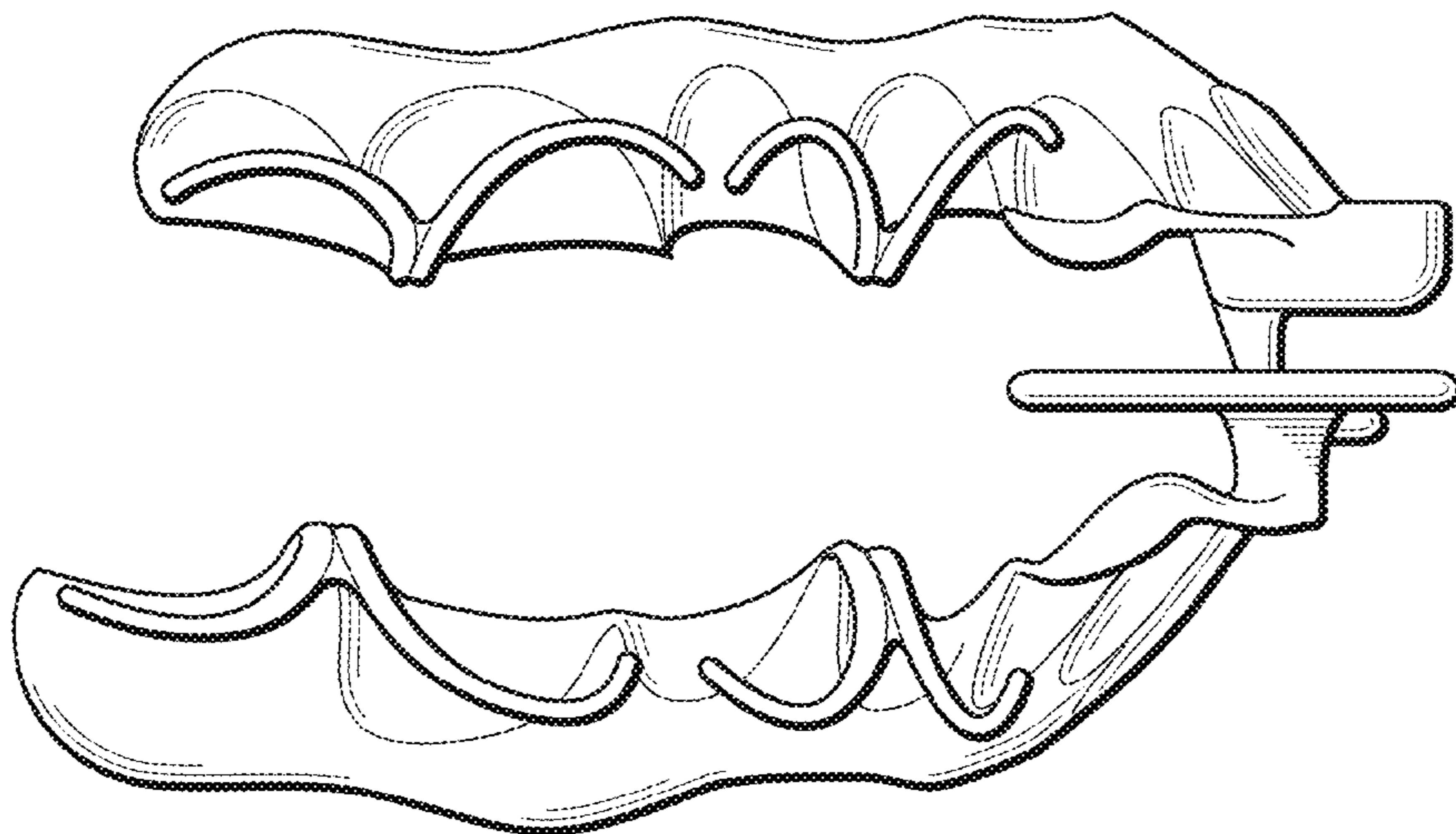

FIG. 4



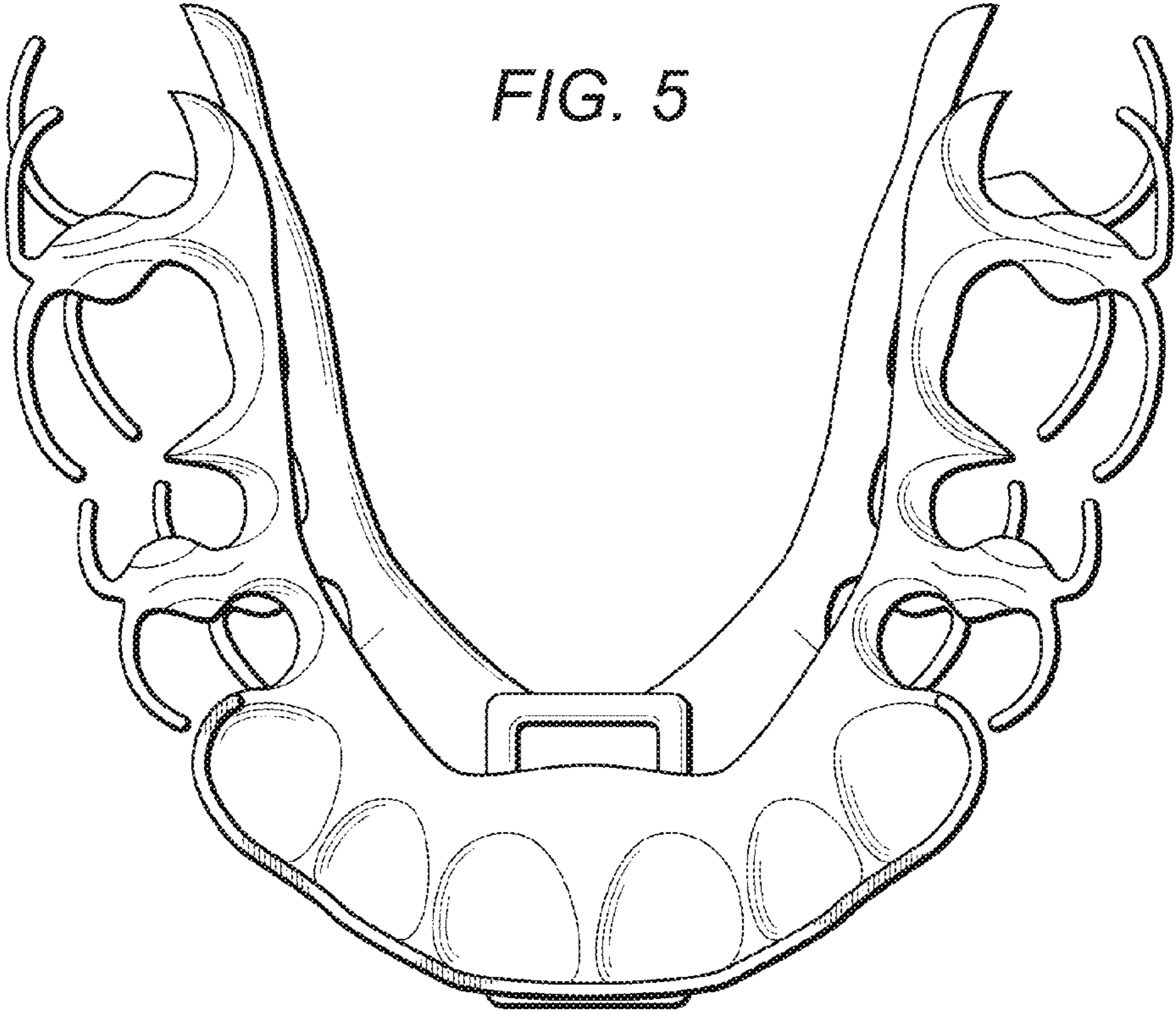

FIG. 5

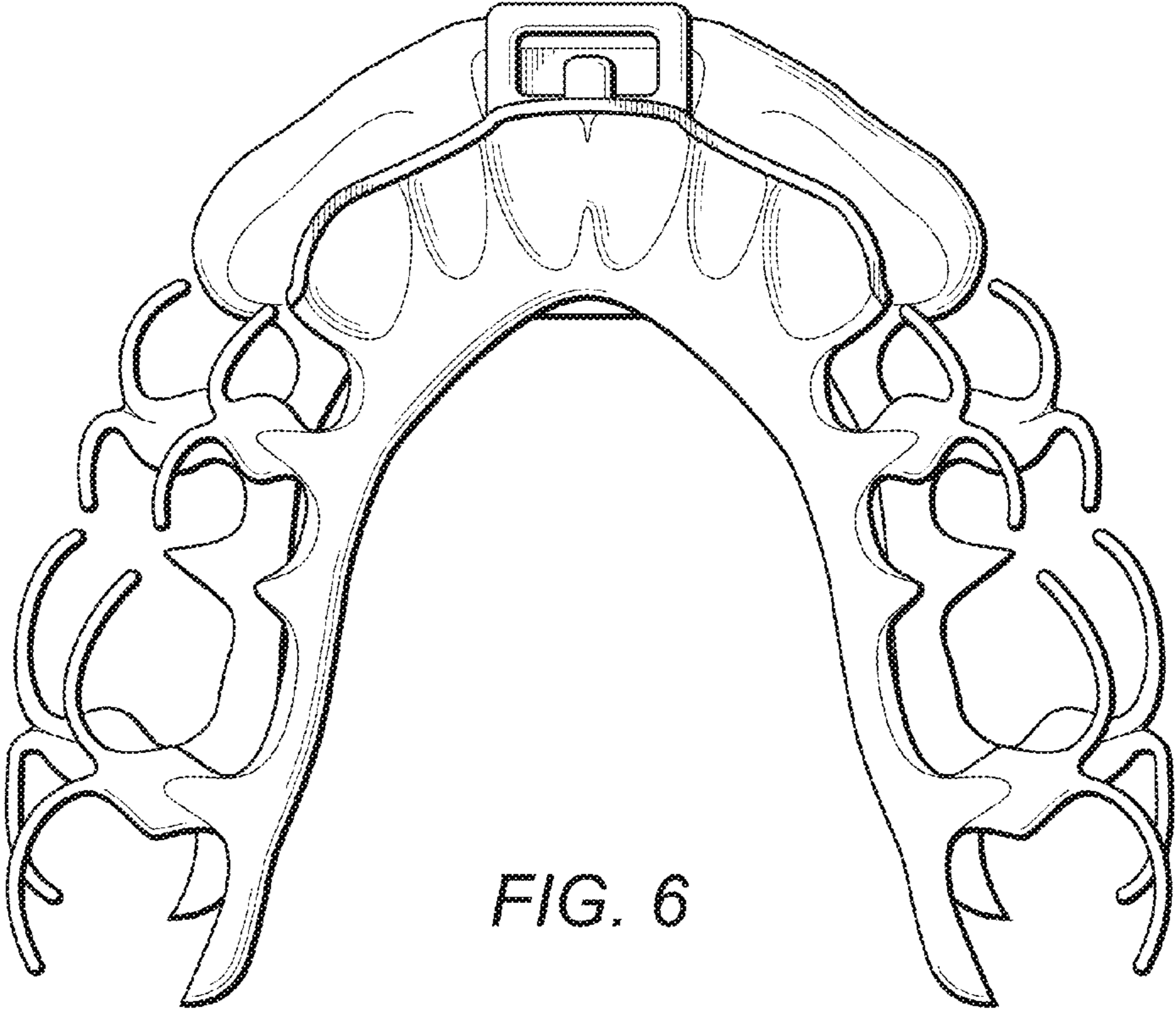

FIG. 6

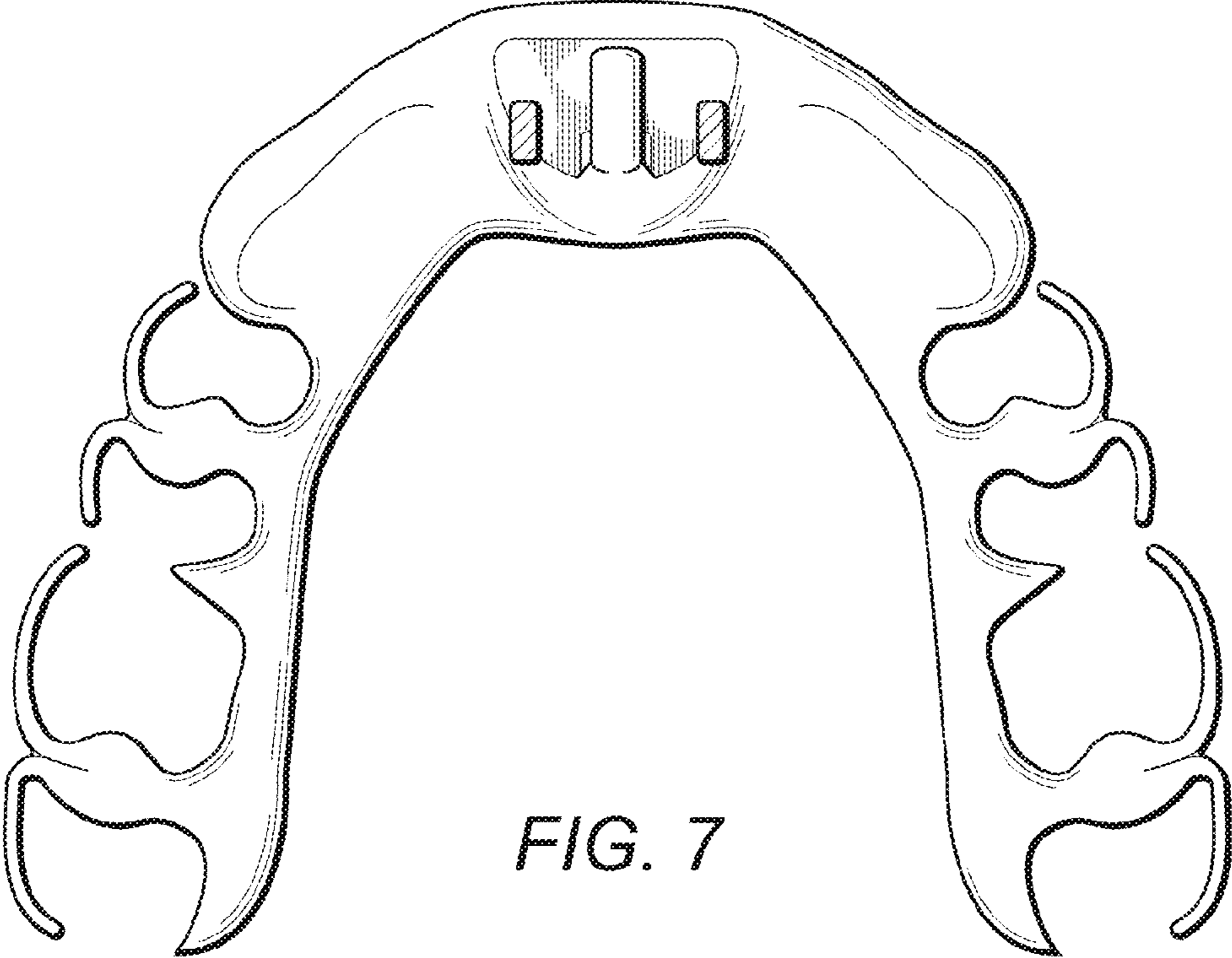

FIG. 7

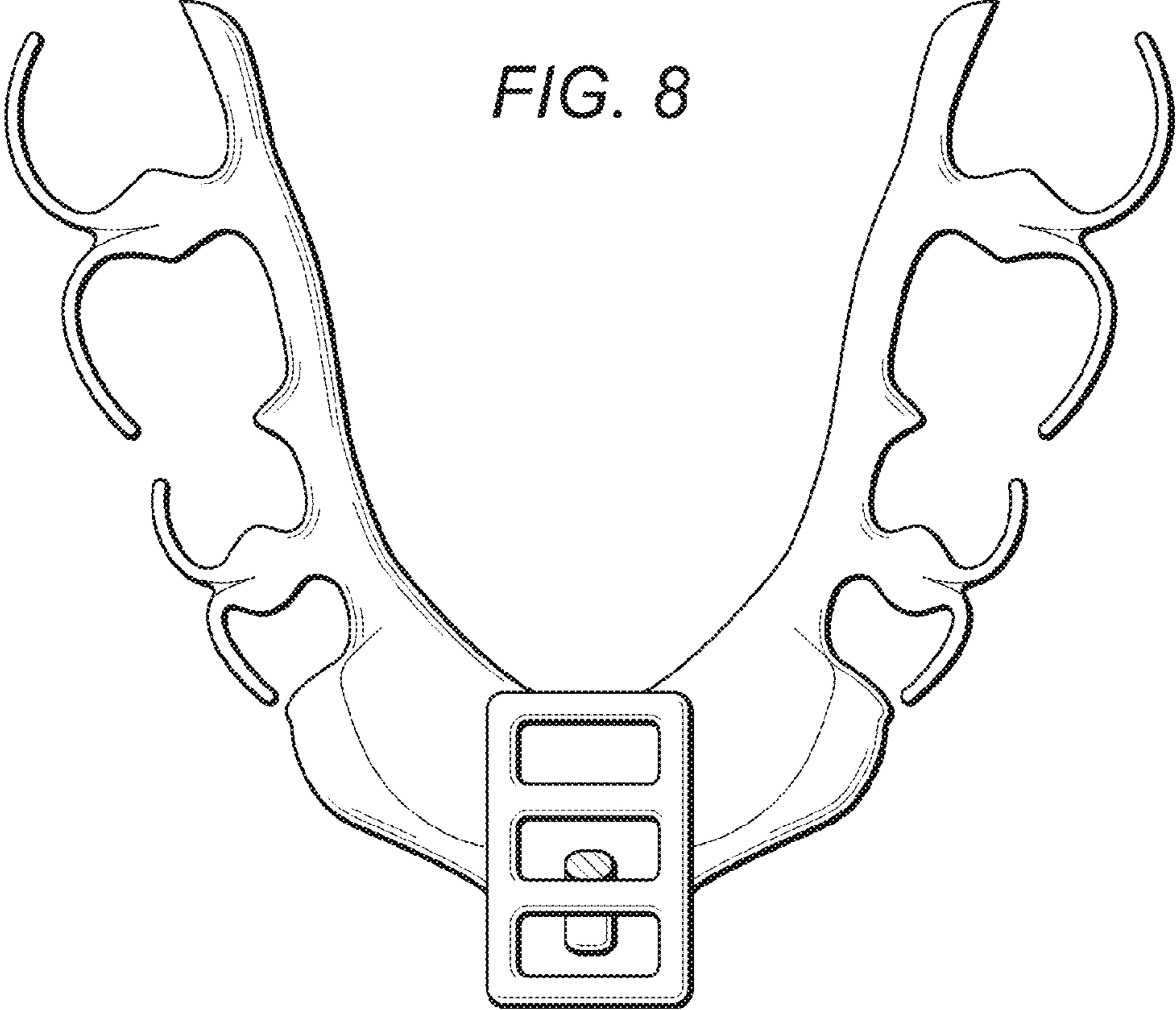

FIG. 8

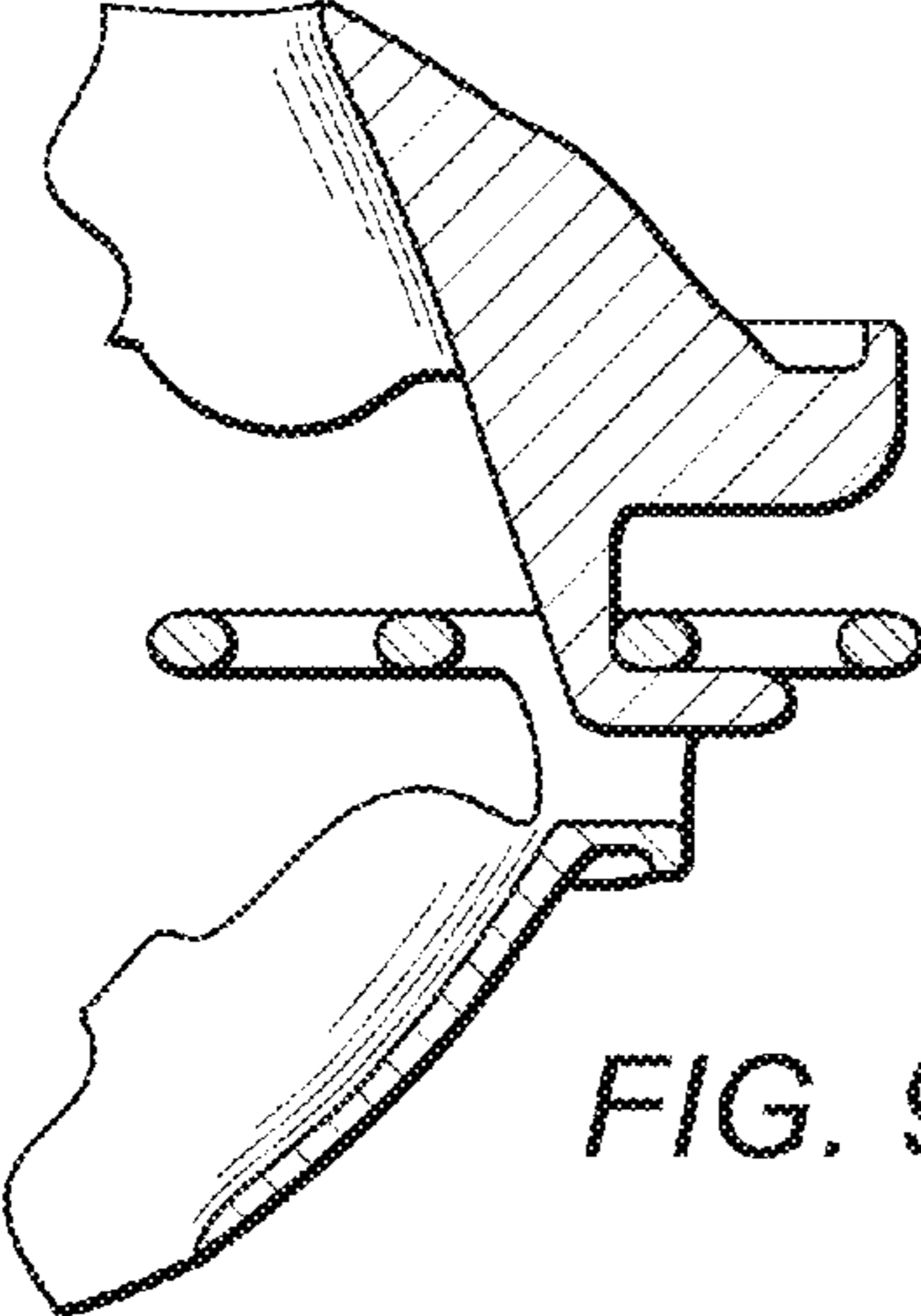

FIG. 9

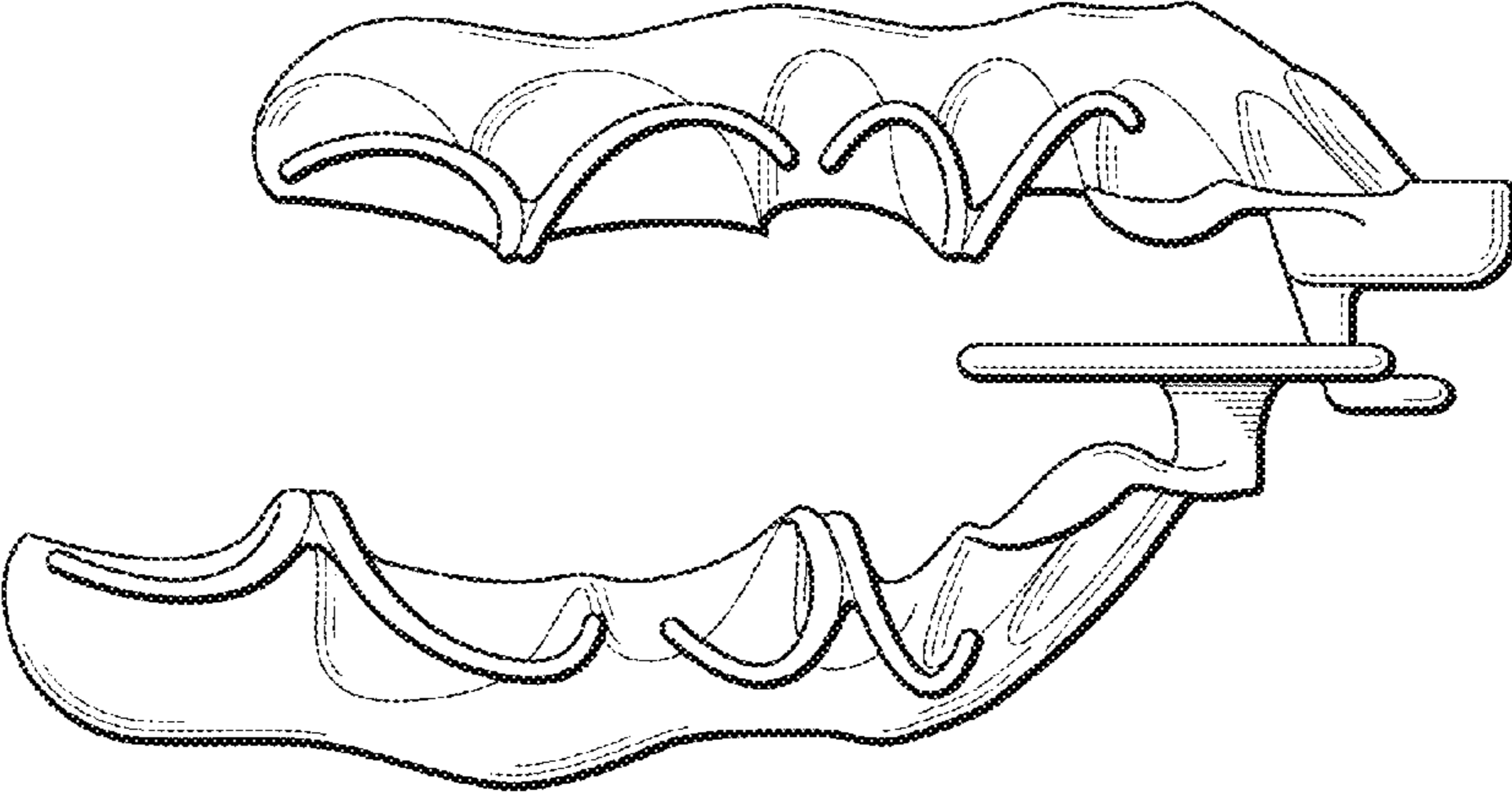

FIG. 10

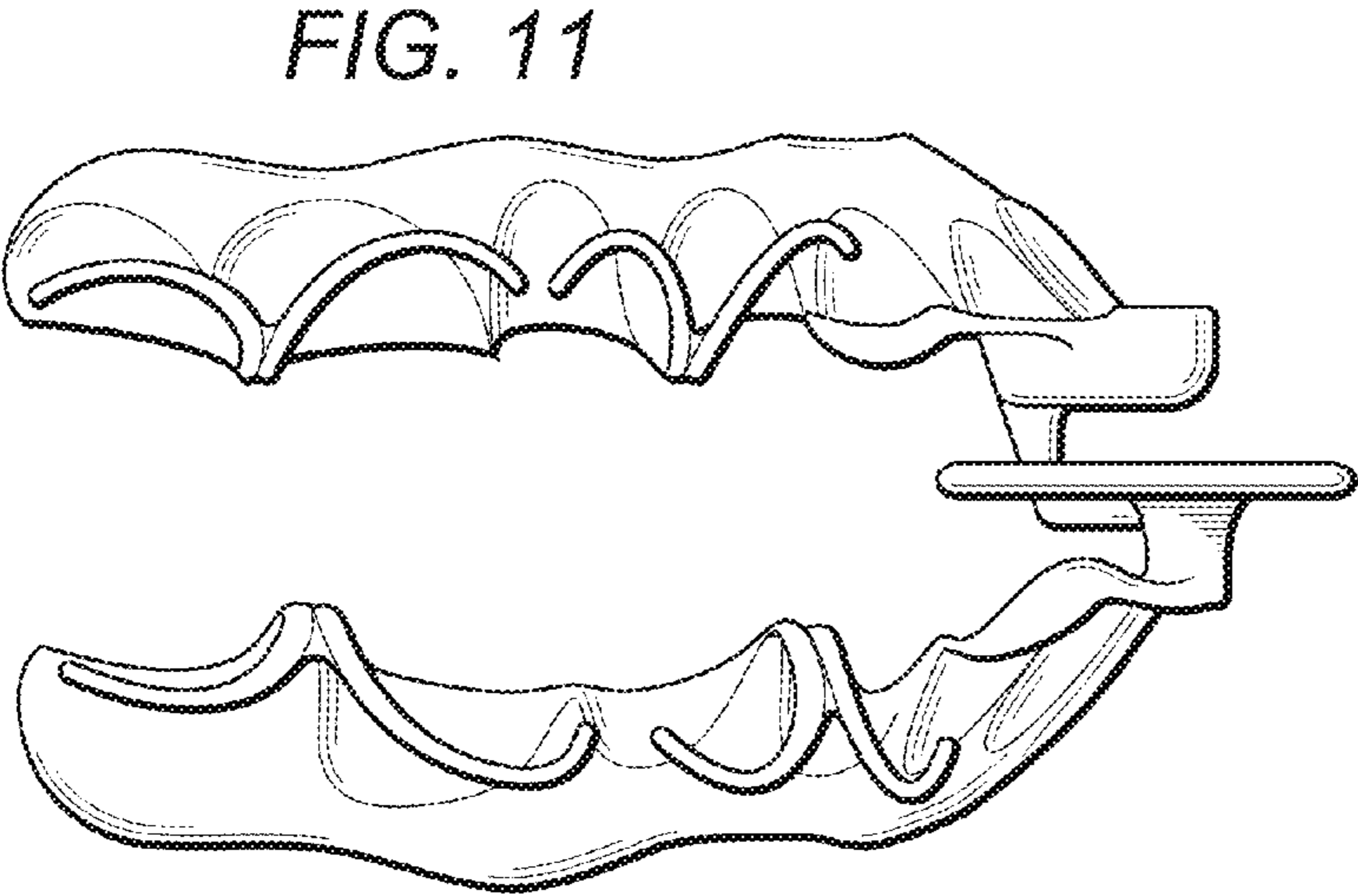

FIG. 11