



US00D752735S

(12) **United States Design Patent**
Scampoli

(10) **Patent No.:** **US D752,735 S**
(45) **Date of Patent:** **** Mar. 29, 2016**

(54) **CANNULA NOSEPIECE**

(56) **References Cited**

(71) Applicant: **KONINKLIJKE PHILIPS N.V.**,
Eindhoven (NL)
(72) Inventor: **David Scampoli**, South Glastonbury, CT
(US)
(73) Assignee: **KONINKLIJKE PHILIPS N.V.**,
Eindhoven (NL)

U.S. PATENT DOCUMENTS

3,643,660	A *	2/1972	Hudson et al.	128/207.18
3,902,486	A *	9/1975	Guichard	128/203.22
4,278,082	A *	7/1981	Blackmer	128/207.18
6,478,026	B1 *	11/2002	Wood	128/207.18
6,776,162	B2 *	8/2004	Wood	128/207.18
7,059,328	B2 *	6/2006	Wood	128/207.18
8,333,200	B2 *	12/2012	Tero	128/207.18
D681,193	S *	4/2013	Thornbury et al.	D24/110.5

(**) Term: **14 Years**

* cited by examiner

(21) Appl. No.: **29/487,350**

Primary Examiner — Deanna L Pratt
Assistant Examiner — Lilyana Bekic

(22) Filed: **Apr. 8, 2014**

(57) **CLAIM**

(30) **Foreign Application Priority Data**

The ornamental design for a cannula nosepiece, as shown and described.

Oct. 8, 2013 (EM) 002321851-0001

DESCRIPTION

(51) **LOC (10) Cl.** **29-02**

FIG. 1 is a perspective view showing my design;
FIG. 2 is a front elevational view thereof;
FIG. 3 is a rear elevational view thereof;
FIG. 4 is a right side elevational view thereof;
FIG. 5 is a left side elevational view thereof;
FIG. 6 is a top plan view thereof; and,
FIG. 7 is a bottom plan view thereof.

(52) **U.S. Cl.**
USPC **D24/110.5**

The broken lines in the drawings illustrate portions of the cannula nosepiece which form no part of the claimed design.

(58) **Field of Classification Search**
USPC D24/110, 110.1, 110.4, 110.5, 112, 164
CPC A61M 16/0666; A61M 16/0672;
A61M 16/0683; A61M 2025/0226; A61M
16/0633; A61M 16/06; A61B 5/6819
See application file for complete search history.

1 Claim, 4 Drawing Sheets

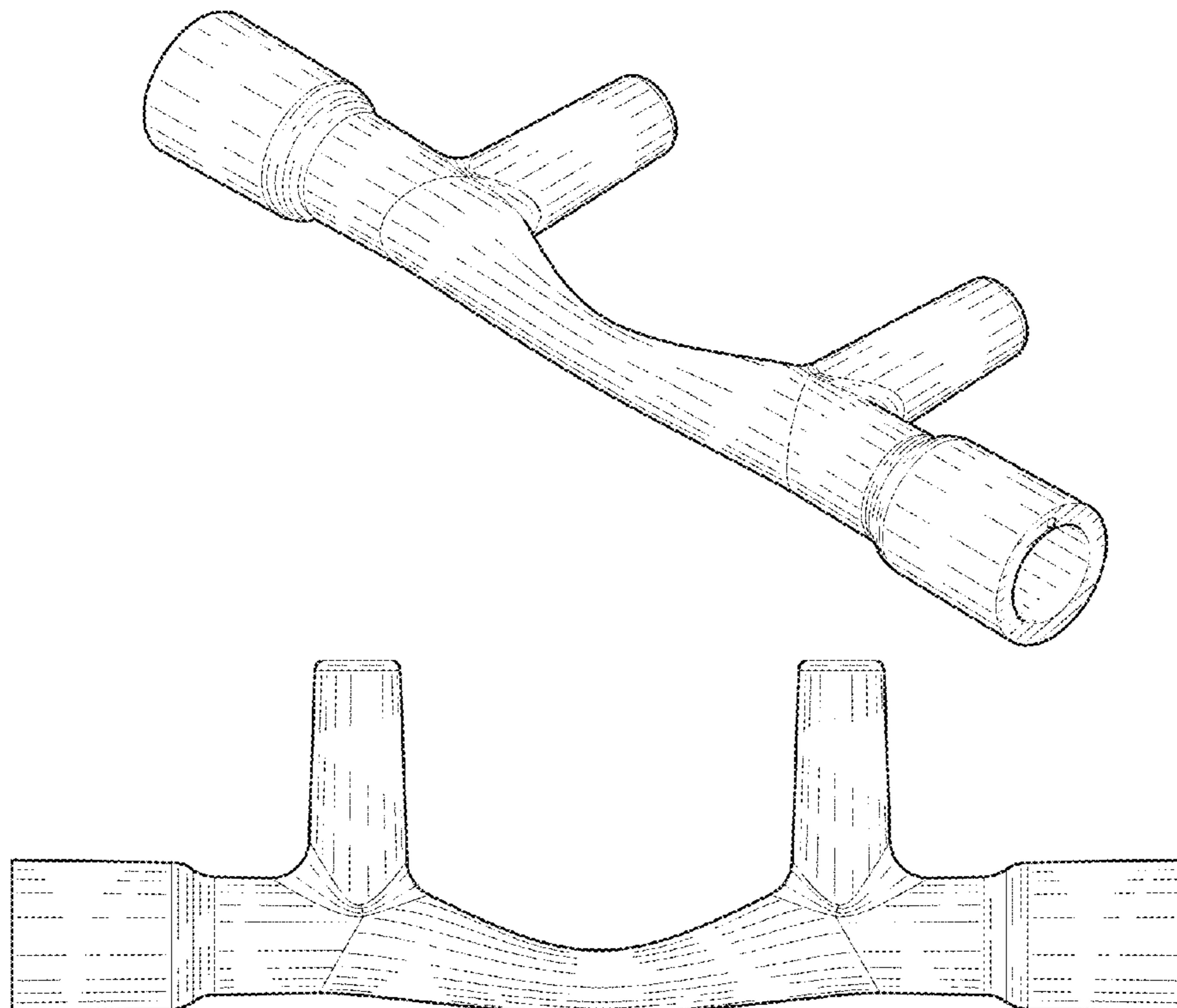

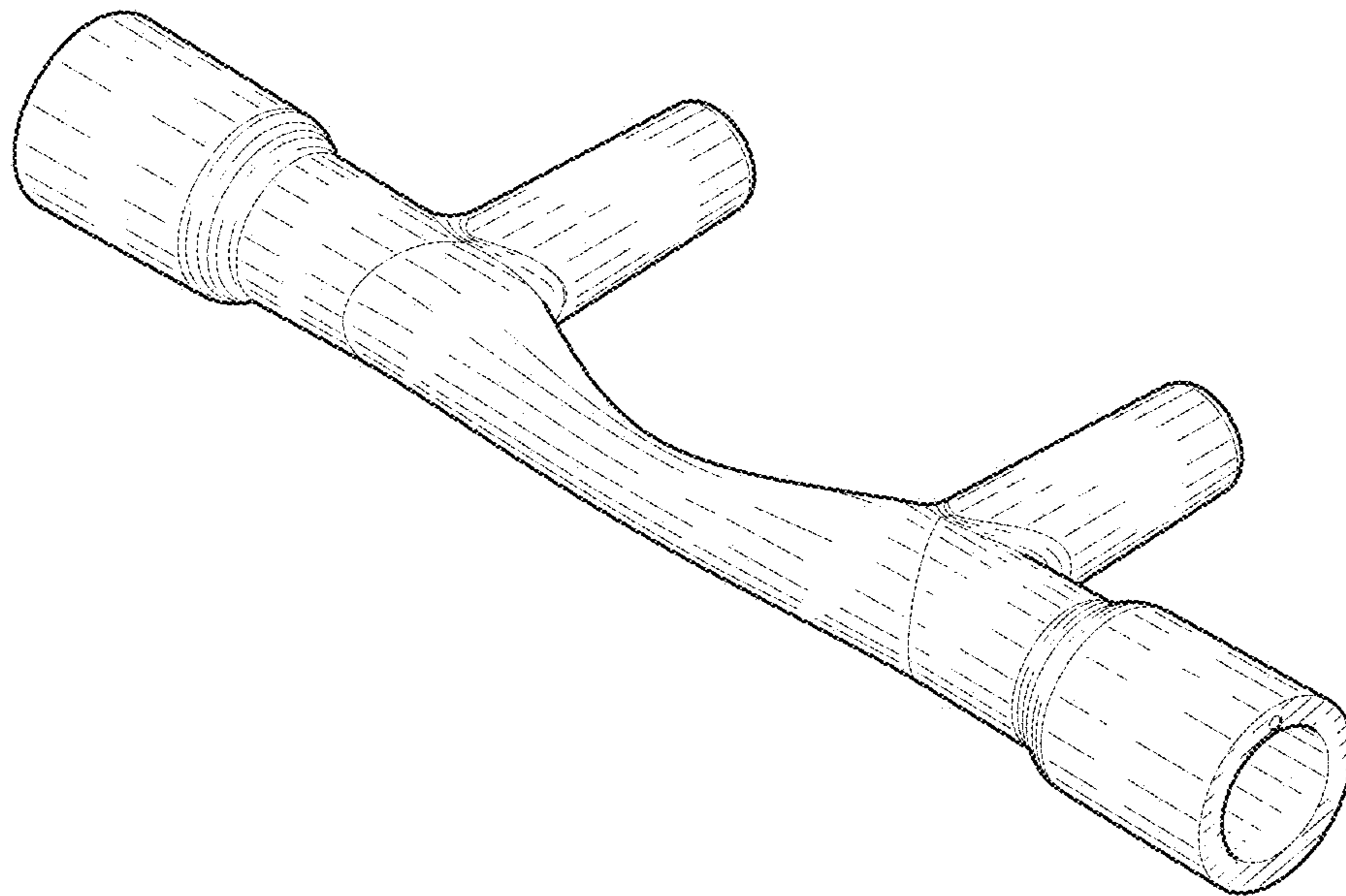

FIG. 1

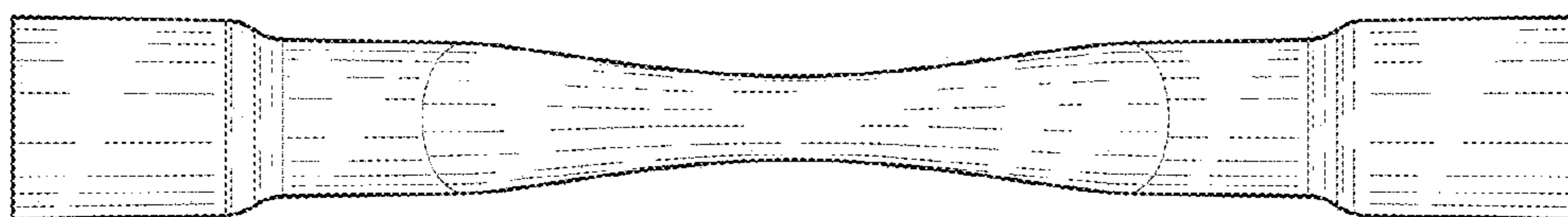

FIG. 2

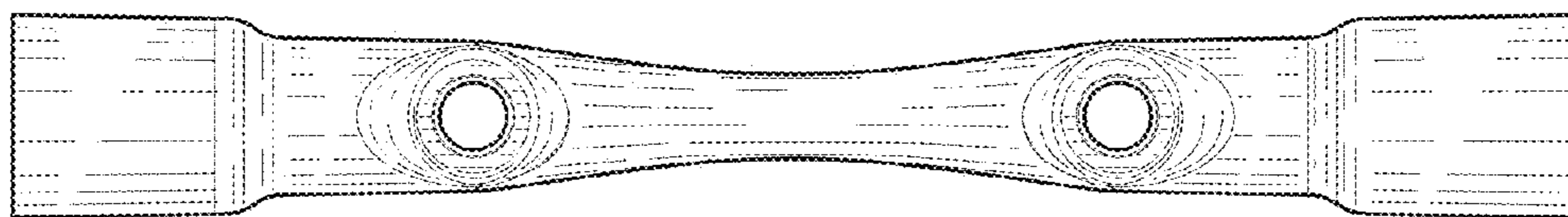

FIG. 3

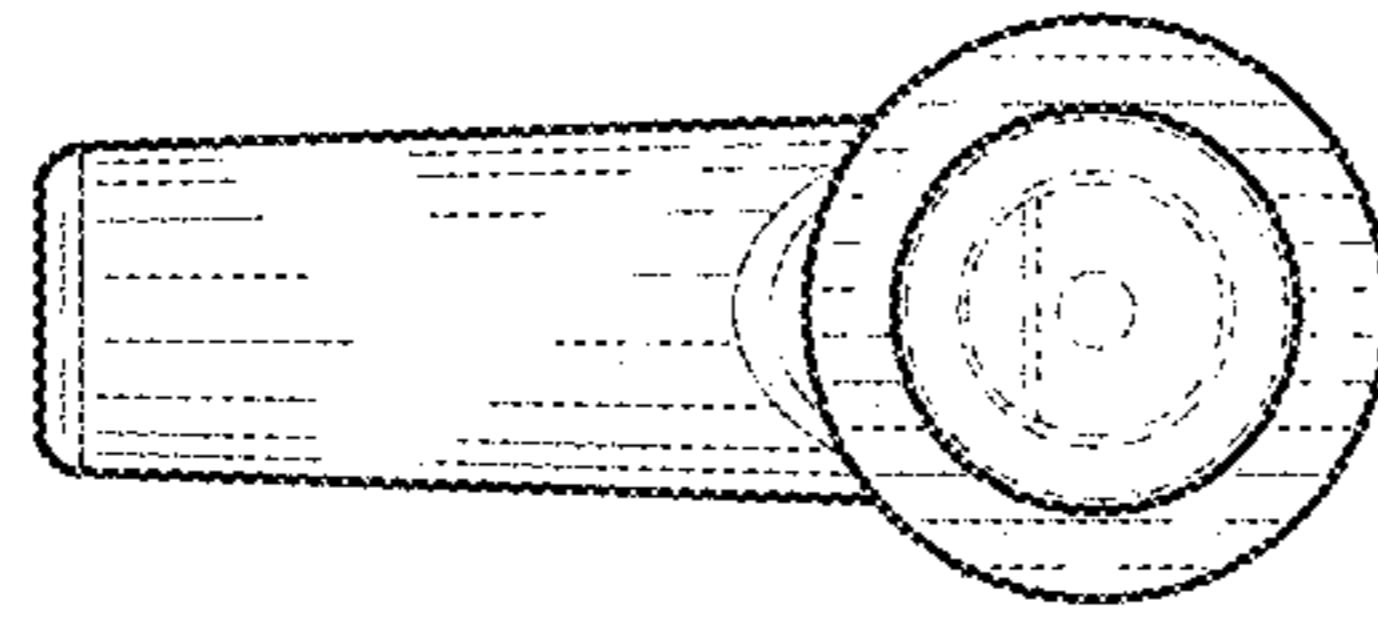

FIG. 4

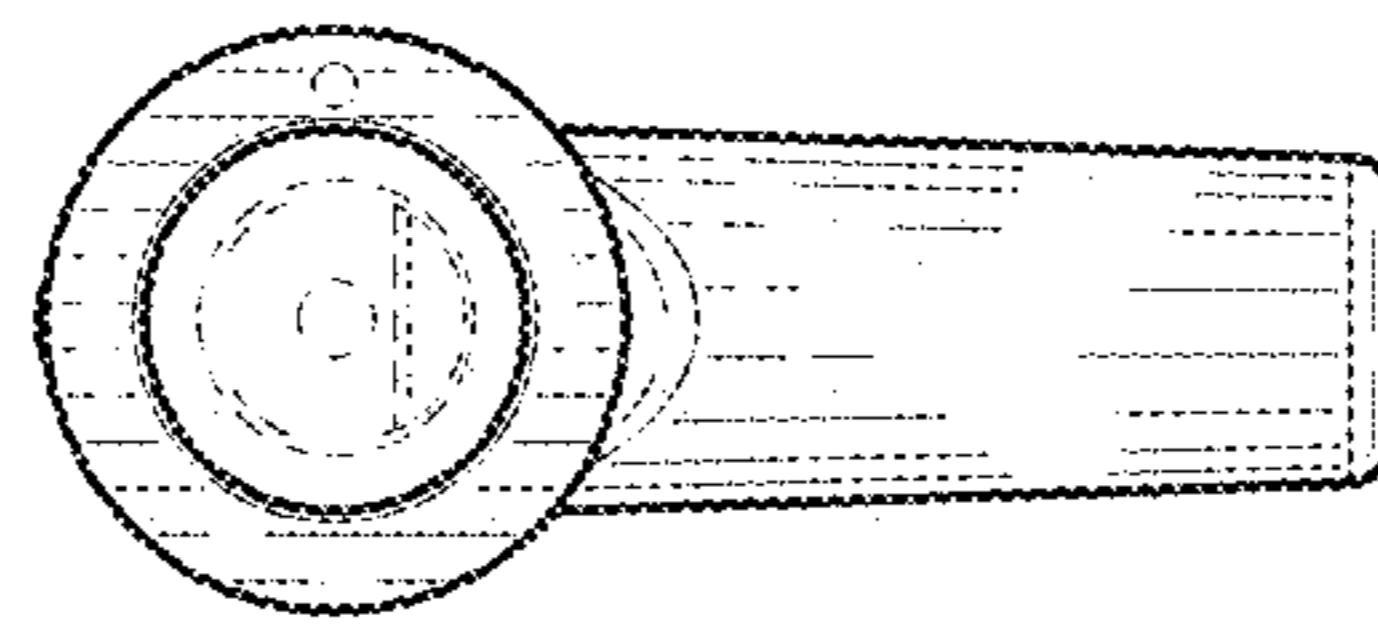

FIG. 5

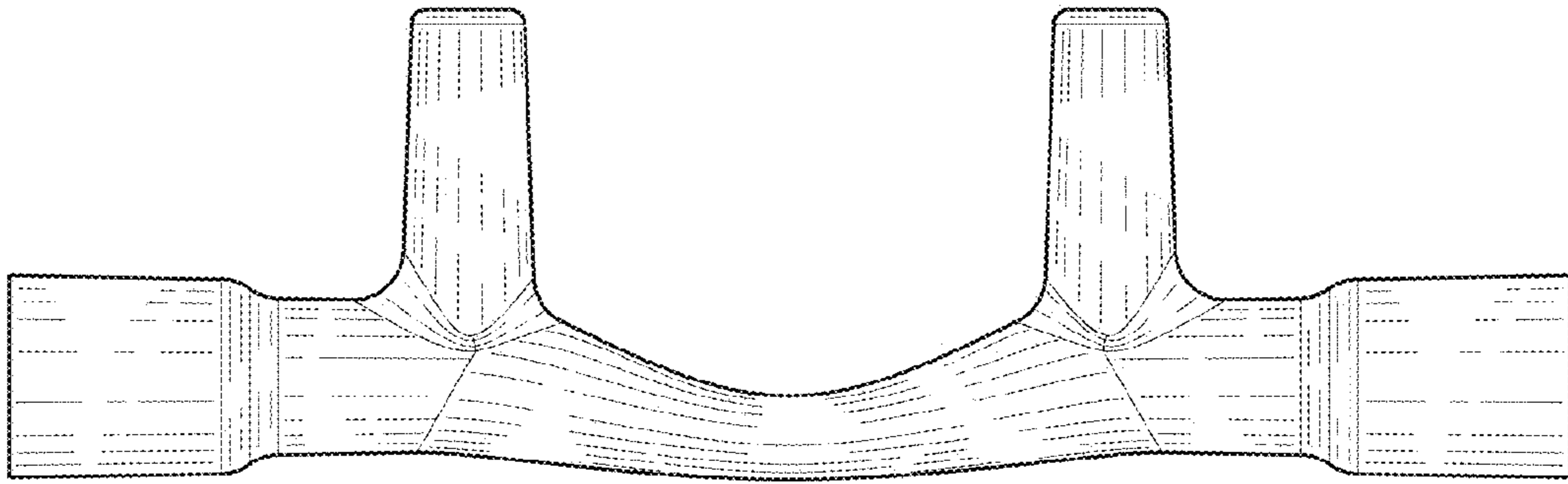

FIG. 6

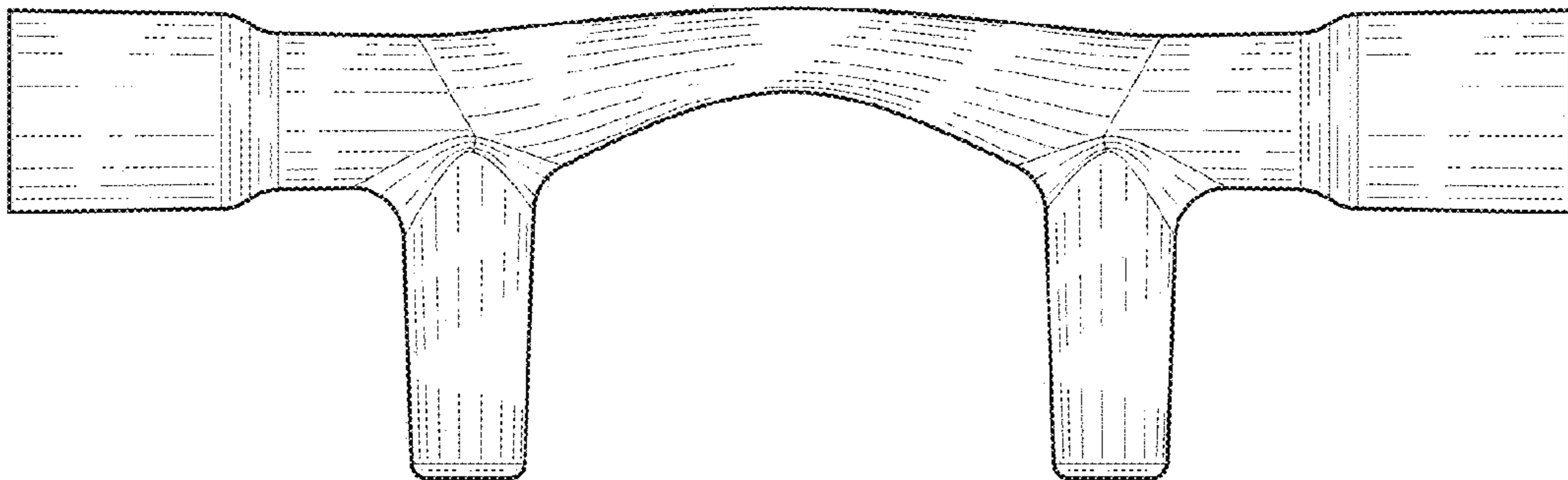

FIG. 7