



US00D752595S

(12) **United States Design Patent**
Heckler

(10) **Patent No.:** **US D752,595 S**
(45) **Date of Patent:** **** Mar. 29, 2016**

- (54) **TABLET COMPUTER STAND**
- (71) Applicant: **Hecktech, Inc.**, Phoenix, AZ (US)
- (72) Inventor: **Dean Heckler**, Phoenix, AZ (US)
- (73) Assignee: **HECKTECH, INC**, Phoenix, AZ (US)
- (**) Term: **14 Years**
- (21) Appl. No.: **29/514,096**
- (22) Filed: **Jan. 8, 2015**
- (51) **LOC (10) Cl.** **08-07**
- (52) **U.S. Cl.**
USPC **D14/447**
- (58) **Field of Classification Search**
USPC D14/447, 432, 434, 439, 440, 451, 452,
D14/457, 250, 251, 253; D3/218; D6/406.3,
D6/406.4, 406.5, 406.6
CPC A45C 2011/003; A45C 2011/002;
A45C 13/002; A47B 2023/049; A47B
2097/005; A47B 2097/006; A47B 21/04;
A47B 23/00; A47B 23/043; A47B 2021/0307;
A47B 2023/005; F16M 2200/00; H04B
1/3888; H04M 1/04; H04M 1/185
See application file for complete search history.

- D703,673 S * 4/2014 Kittlaus D14/447
- D704,201 S * 5/2014 Shubin, Sr. D14/447
- D717,306 S * 11/2014 Clouser D14/447
- D722,317 S * 2/2015 Parameshwara D14/447
- D724,598 S * 3/2015 Gelsomini D14/447
- D733,526 S * 7/2015 Delrue D14/447

* cited by examiner

Primary Examiner — Angela J Lee

(74) *Attorney, Agent, or Firm* — Hartman Titus PLC; John D. Titus

(57) **CLAIM**

The ornamental design for a tablet computer stand, as shown and described.

DESCRIPTION

FIG. 1 is a front perspective view of a tablet computer stand showing my new design;
 FIG. 2 is a top view of the tablet computer stand shown in FIG. 1;
 FIG. 3 is a bottom view of the tablet computer stand shown in FIG. 1;
 FIG. 4 is a front view of the tablet computer stand shown in FIG. 1;
 FIG. 5 is a rear view of the tablet computer stand shown in FIG. 1;
 FIG. 6 is a left side view of the tablet computer stand shown in FIG. 1; and,
 FIG. 7 is a right side view of the tablet computer stand shown in FIG. 1.
 The broken lines shown in the drawings represent portions of the tablet computer stand that form no part of the claimed design.

(56) **References Cited**

U.S. PATENT DOCUMENTS

- D649,153 S * 11/2011 Symons D14/447
- D652,043 S * 1/2012 Lee D14/447
- D652,834 S * 1/2012 Jones D14/434
- D687,832 S * 8/2013 Edwards D14/447
- D689,478 S * 9/2013 Wikel D14/253
- D692,435 S * 10/2013 Bremenkamp D14/447
- D695,732 S * 12/2013 Baumann D14/253

1 Claim, 4 Drawing Sheets

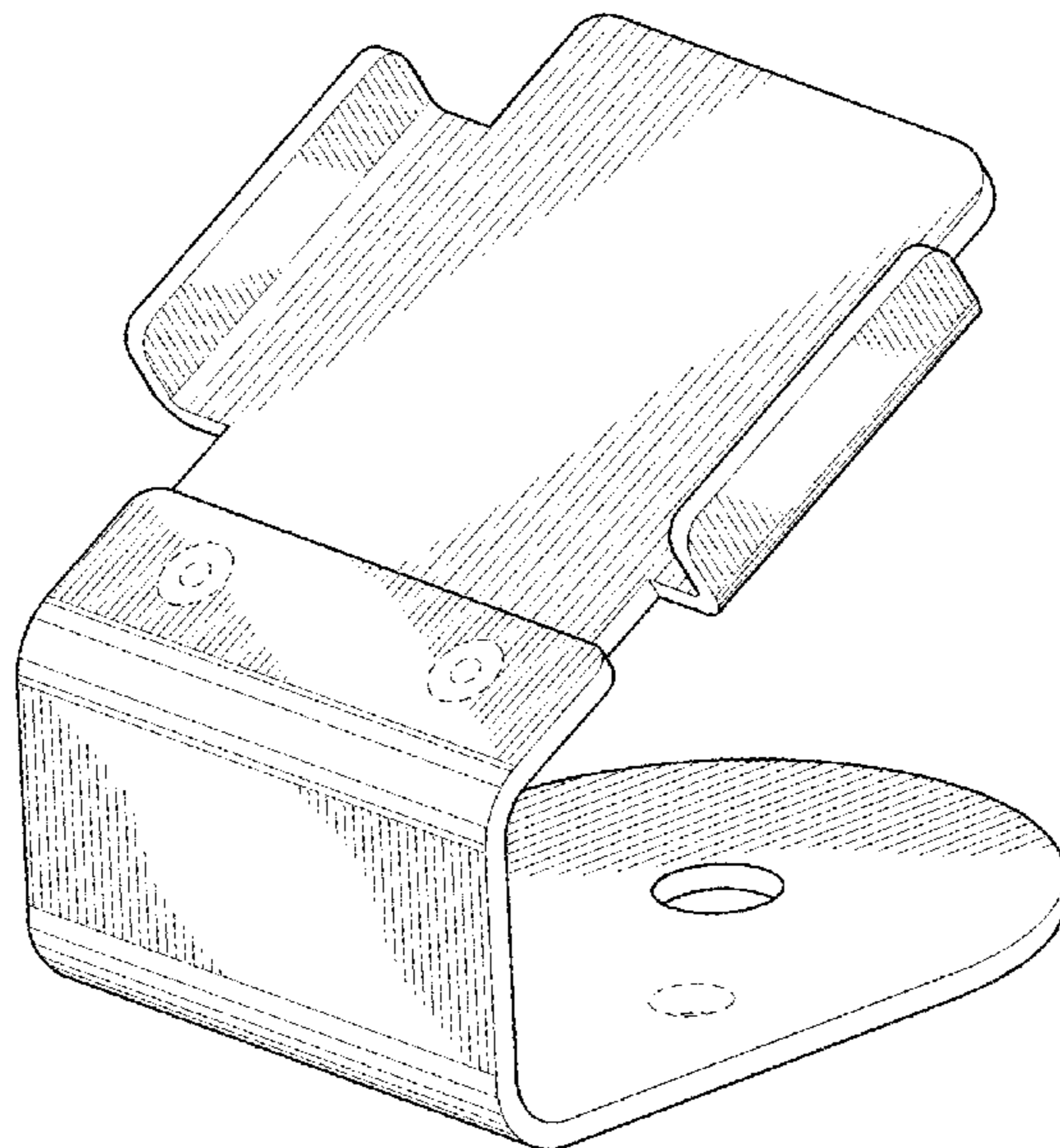

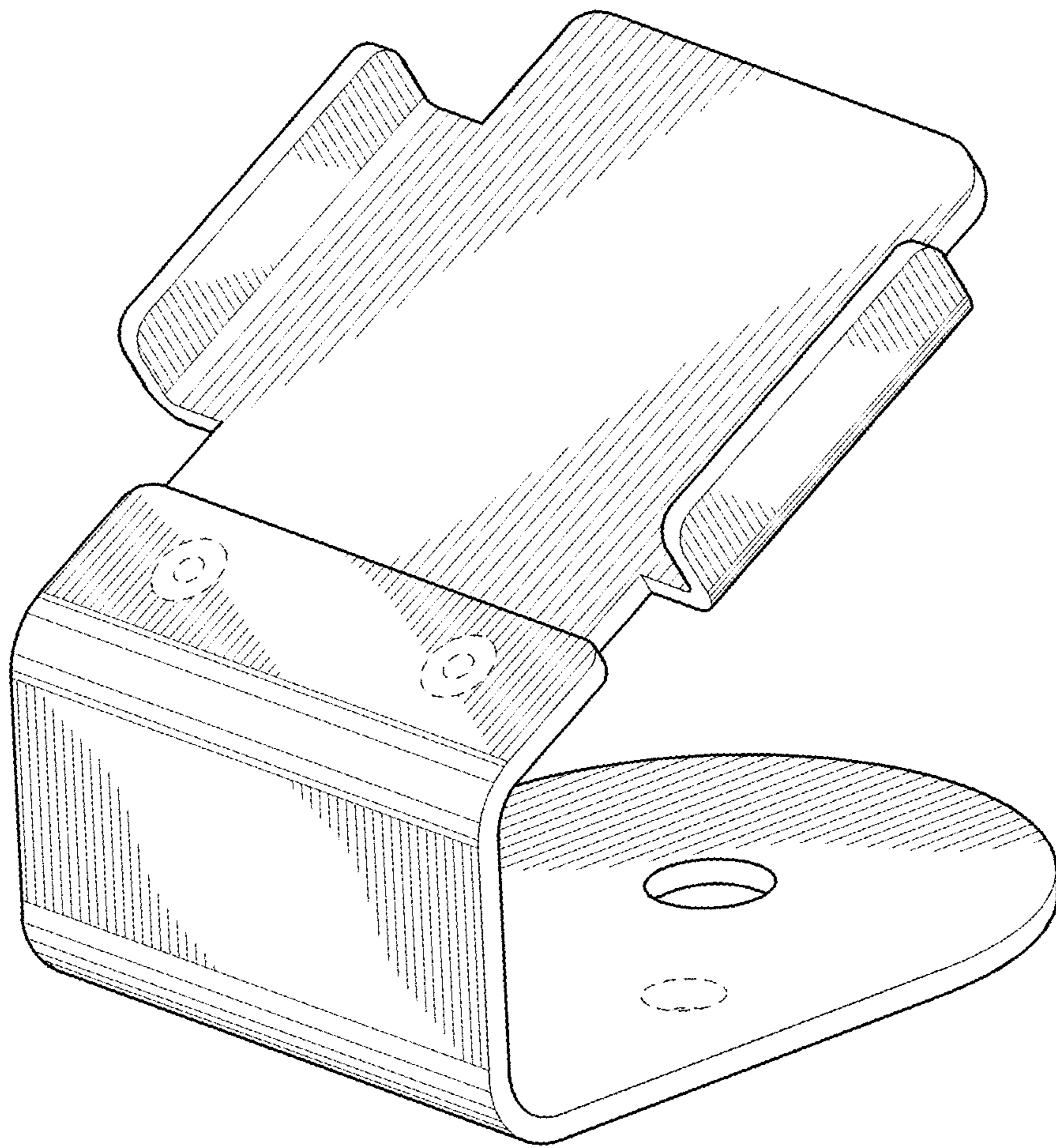

Fig. 1

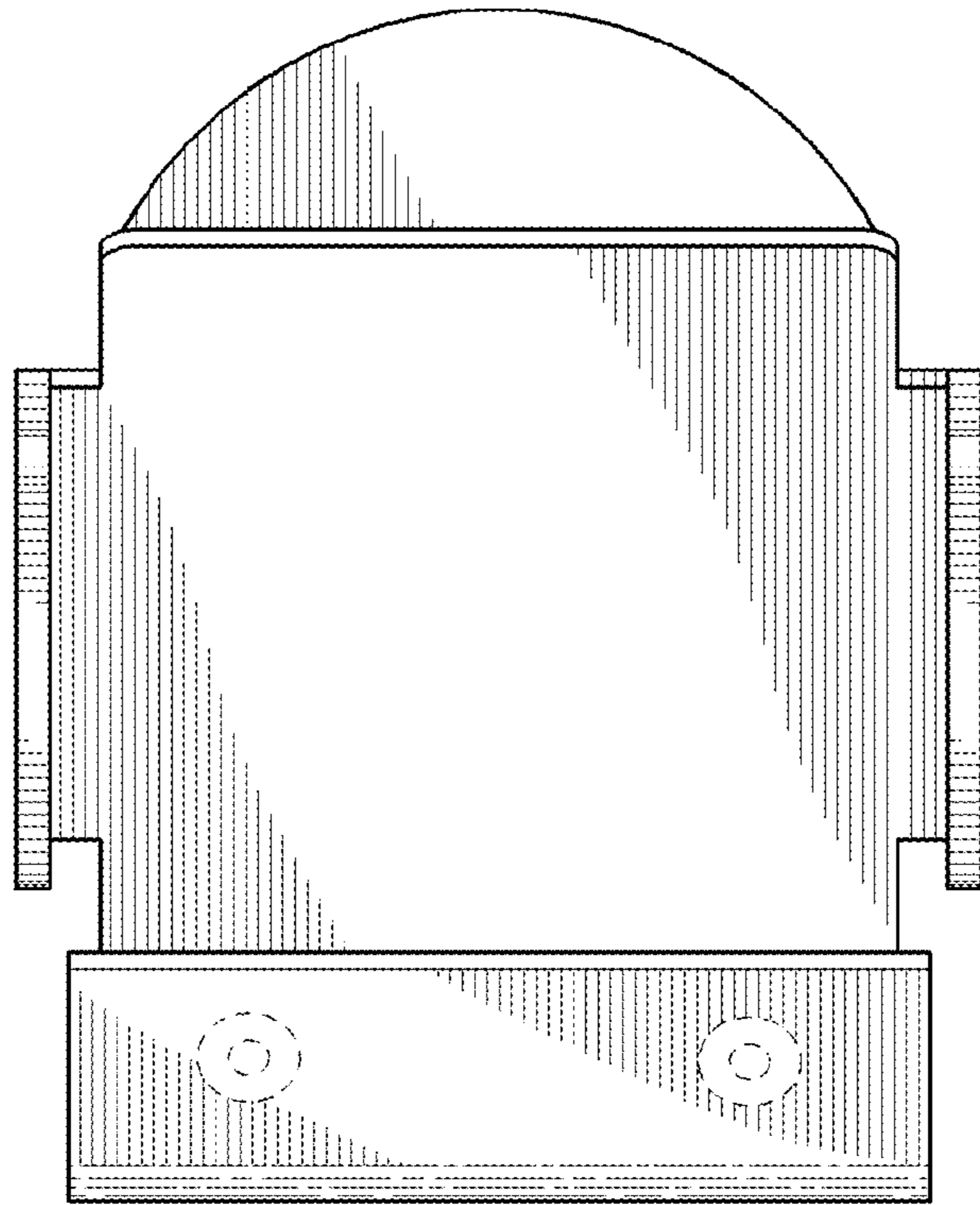

Fig. 2

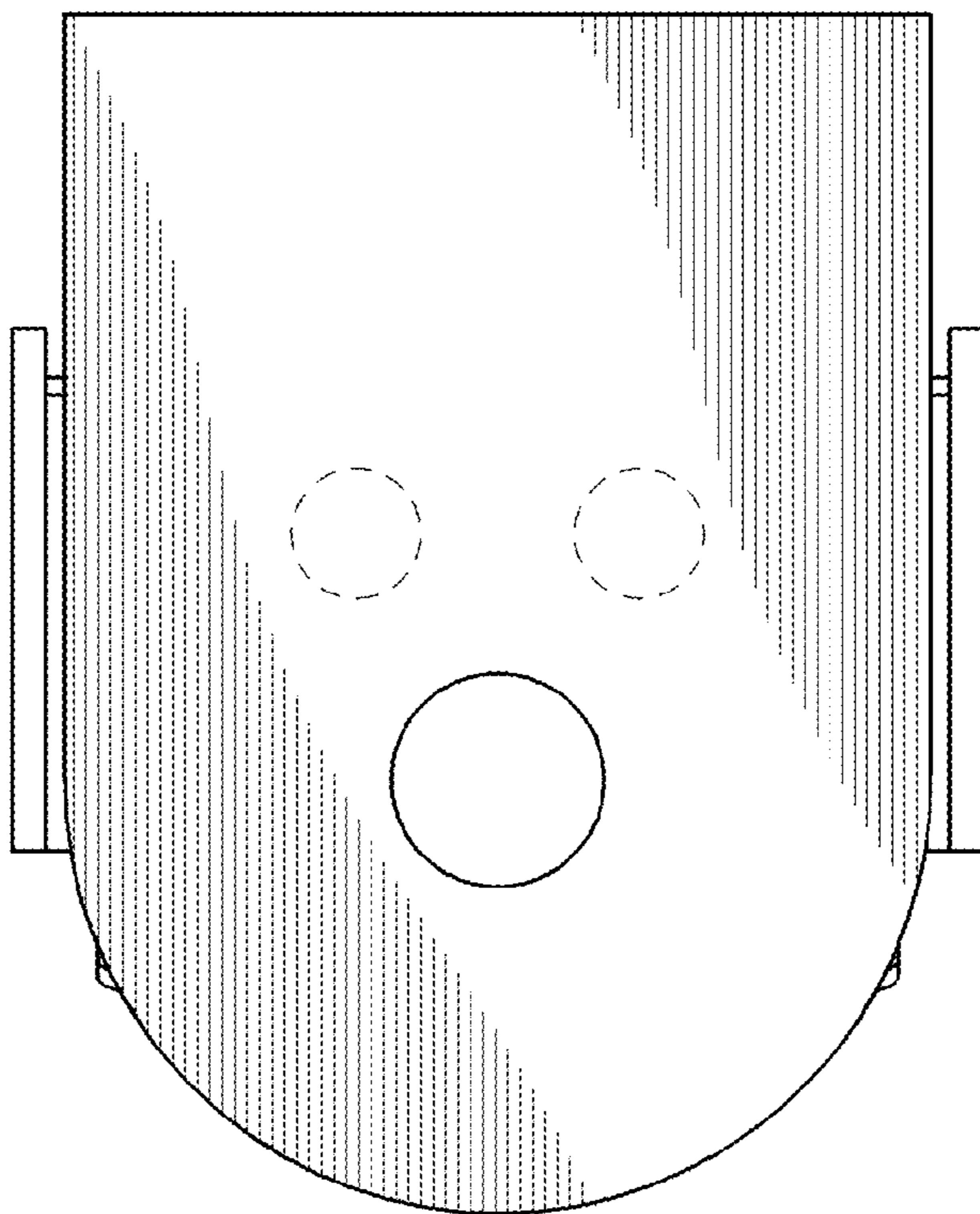

Fig. 3

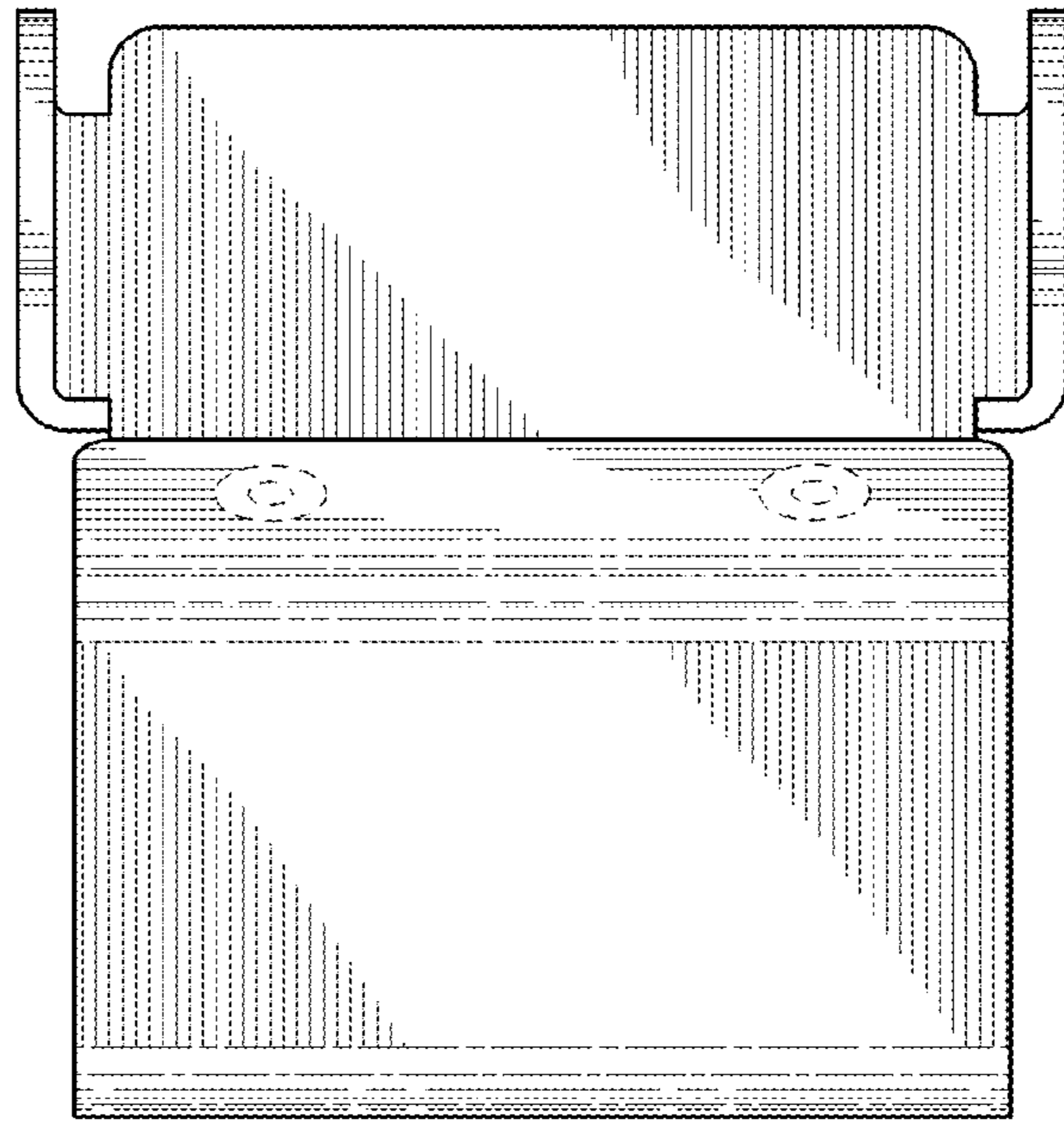

Fig. 4

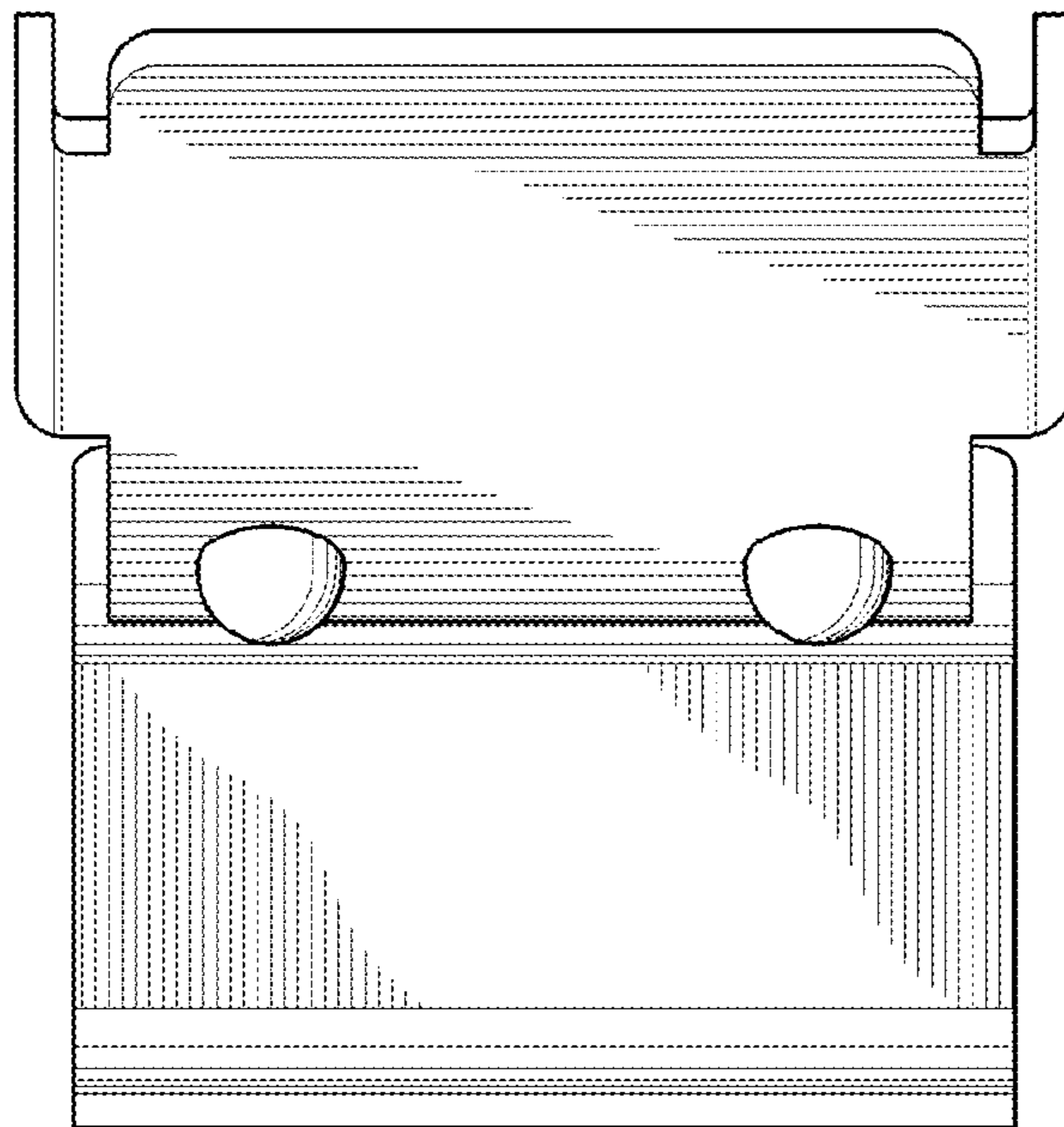

Fig. 5

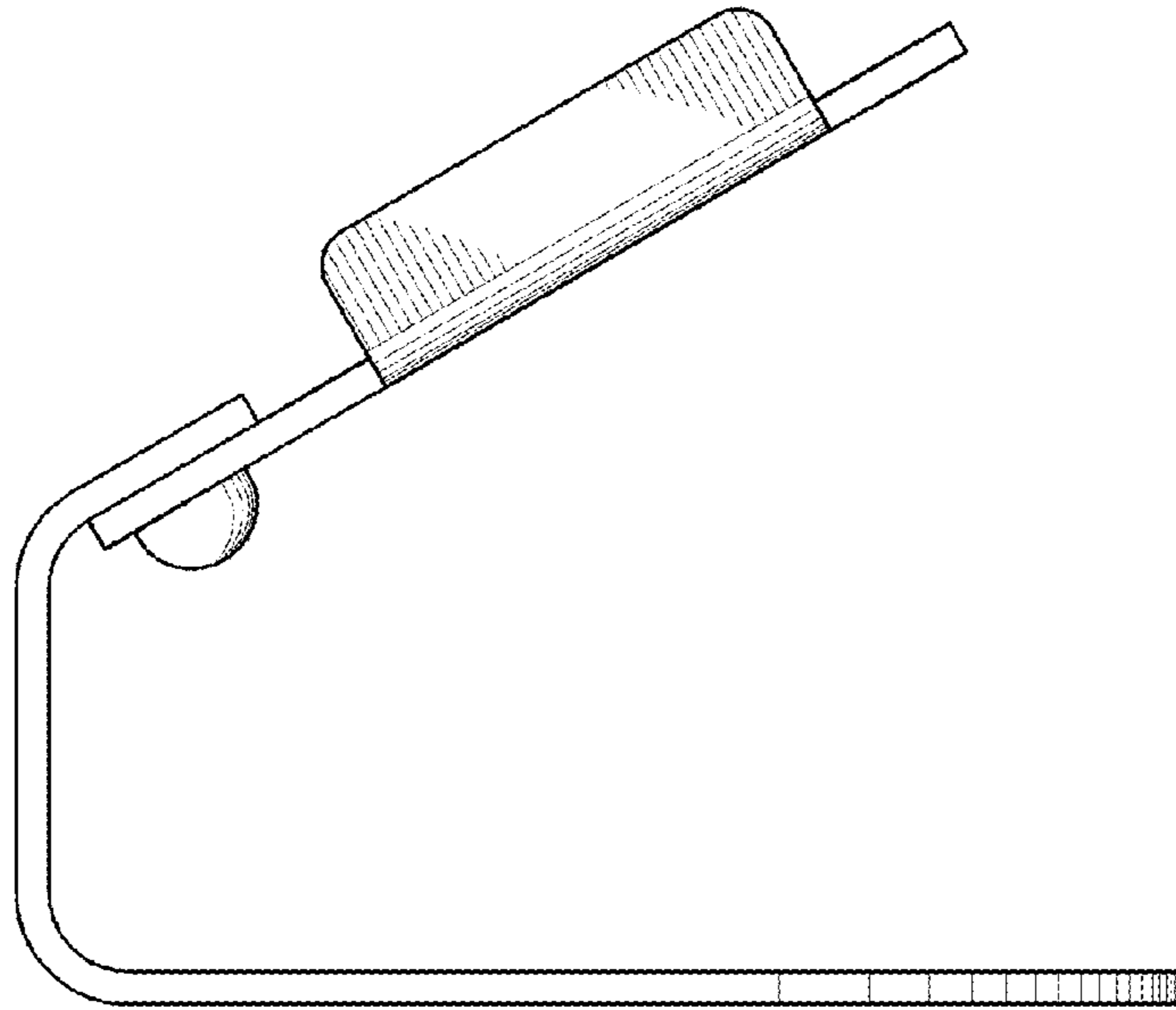

Fig. 6

Fig. 7

