

US00D752554S

(12) **United States Design Patent**
Valeur

(10) **Patent No.:** **US D752,554 S**
(45) **Date of Patent:** **** Mar. 29, 2016**

(54) **REMOTE CONTROL**

(71) Applicant: **BANG & OLUFSEN A/S**, Struer (DK)

(72) Inventor: **Torsten Valeur**, København V (DK)

(73) Assignee: **Bang & Olufsen A/S**, Struer (DK)

(**) Term: **14 Years**

(21) Appl. No.: **29/503,203**

(22) Filed: **Sep. 24, 2014**

(30) **Foreign Application Priority Data**

Mar. 24, 2014 (EM) 002431155

(51) **LOC (10) Cl.** **14-03**

(52) **U.S. Cl.**
USPC **D14/218**

(58) **Field of Classification Search**
USPC D14/218, 349, 480.5; D13/168, 173,
D13/162, 162.1, 166, 171, 174
CPC H04N 5/4403; H04N 5/765; G08C 23/04
See application file for complete search history.

(56) **References Cited**

U.S. PATENT DOCUMENTS

D266,758 S	*	11/1982	Johannsen	D13/168
D531,993 S	*	11/2006	Choi	D14/218
D534,900 S	*	1/2007	Weitgasser	D14/218
D544,467 S	*	6/2007	Tsuge	D14/218
D583,363 S	*	12/2008	Song	D13/168
D594,852 S	*	6/2009	Klein	D14/218
D596,630 S	*	7/2009	Kaneta	D14/247
D606,982 S	*	12/2009	Kaneko	D14/218
D609,222 S	*	2/2010	Shin	D14/218
D614,607 S	*	4/2010	Kamegi	D14/218
D637,179 S	*	5/2011	Chiu	D14/218
D647,510 S	*	10/2011	Maier	D14/218

D647,511 S	*	10/2011	Maier	D14/218
D648,327 S	*	11/2011	Maier	D14/218
D656,487 S	*	3/2012	Corsini	D14/218
D658,636 S	*	5/2012	Maier	D14/218

(Continued)

FOREIGN PATENT DOCUMENTS

EM	001596305-0001	*	8/2009
EM	001184634-0002	*	1/2010

OTHER PUBLICATIONS

Amazon.com: TV Remote Control for LG AKB73615303, review date Aug. 10, 2014, online, http://www.amazon.com/...s_dp_ss_1?pf_rd_p=1944687442&pf_rd_s=lpo-top-stripe-1&pf_rd_t=201&pf_rd_i=B00KGI69Z6&pf_rd_m=ATVPDKIKX0DER&pf_rd_r=1762Z07J1XESPHJQYYX9, [site visited Oct. 13, 2015 6:27:06 PM].*

(Continued)

Primary Examiner — John Windmuller

Assistant Examiner — John R Yeh

(74) *Attorney, Agent, or Firm* — Dykema Gossett PLLC

(57) **CLAIM**

The ornamental design for a remote control, as shown and described.

DESCRIPTION

FIG. 1 is a front, side, and top perspective view of a first embodiment of a remote control showing my design; FIG. 2 is a front elevation view of FIG. 1; FIG. 3 is a left side elevation view of FIG. 1, wherein the right side elevation view is a mirror image thereof; FIG. 4 is a rear, side, and top perspective view of FIG. 1; FIG. 5 is a rear elevation view of FIG. 1; FIG. 6 is a top plan view of FIG. 1; and, FIG. 7 is a bottom plan view of FIG. 1.

1 Claim, 4 Drawing Sheets

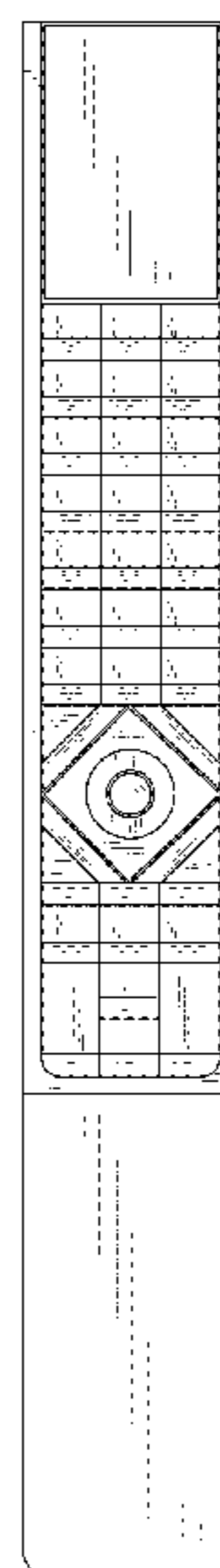
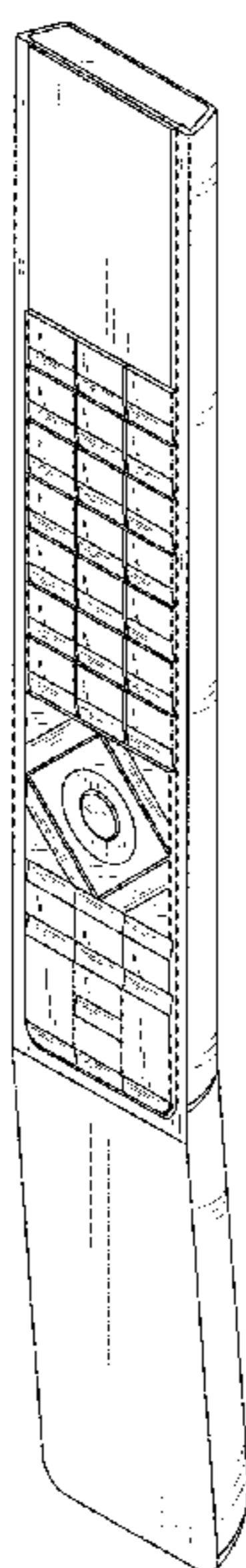

(56)

References Cited

U.S. PATENT DOCUMENTS

D665,779 S * 8/2012 Olufemi D14/218
D679,681 S * 4/2013 Ann D14/218
D692,417 S * 10/2013 Tu D14/218
D697,499 S * 1/2014 McManigal D14/218
D724,062 S * 3/2015 Feldstein D14/218

OTHER PUBLICATIONS

B&O BeoPlay V1 Review, article date May 25, 2012, online, <http://www.hdtv-news.com/reviews/beoplay-v1-review/>, [site visited Oct. 21, 2015 7:16:54 PM].*

BeoPhile.com . . . Speaking the language of Bang & Olufsen, article date Sep. 6, 2014, online, <http://beophile.com/?paged=34>, [site visited Oct. 21, 2015 7:19:09 PM].*

For Sale—Bang & Olufsen BeoVision 8—26" LCD Television—Elgg/Winterthur—English Forum Switzerland, post date Oct. 5, 2009, <http://www.englishforum.ch/items-sale/63494-sale-bang-olufsen-beovision-8-26-lcd-television-elgg-winterthur.html>, [site visited Oct. 21, 2015 7:21:45 PM].*

* cited by examiner

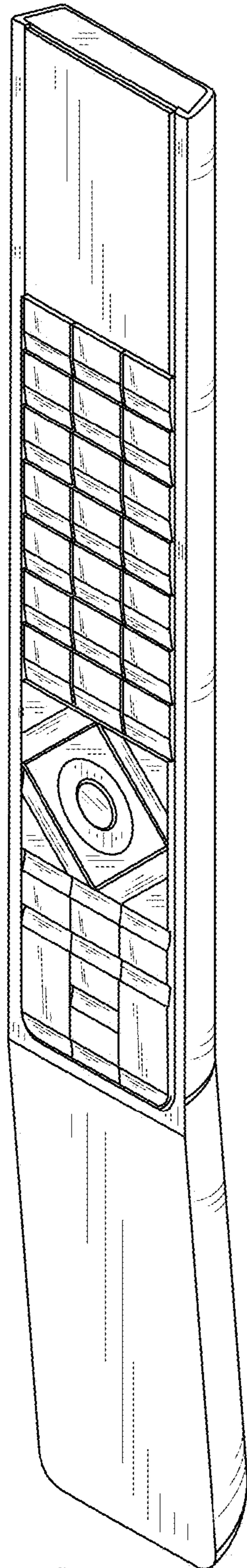

FIG. 1

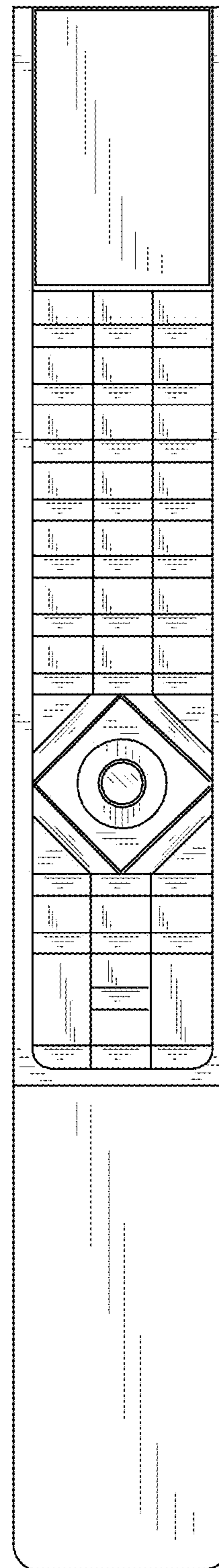

FIG. 2

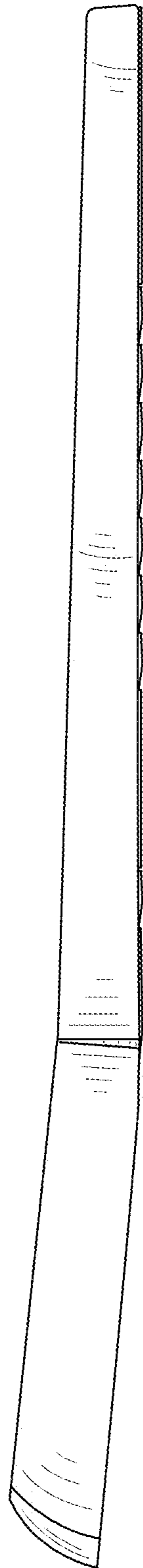

FIG. 3

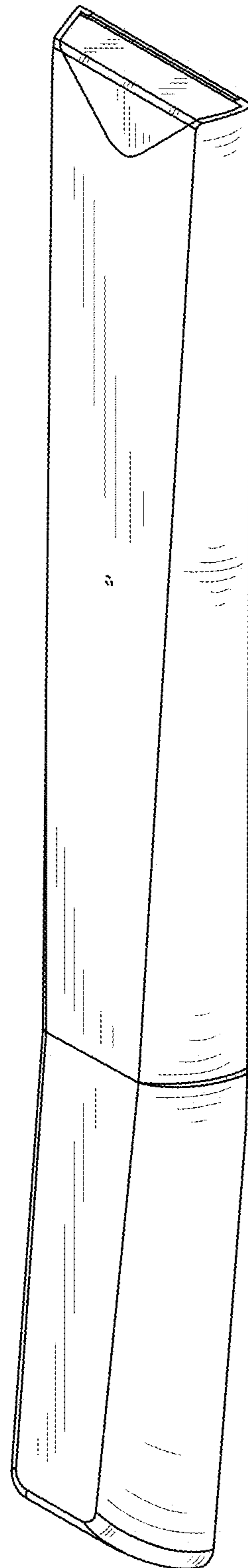

FIG. 4

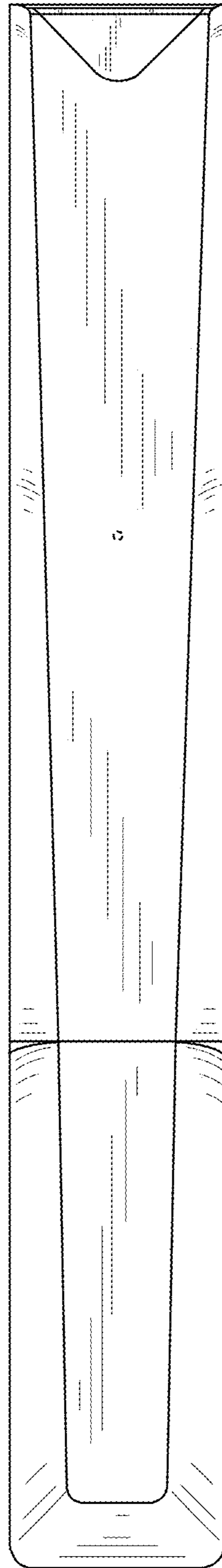

FIG. 5

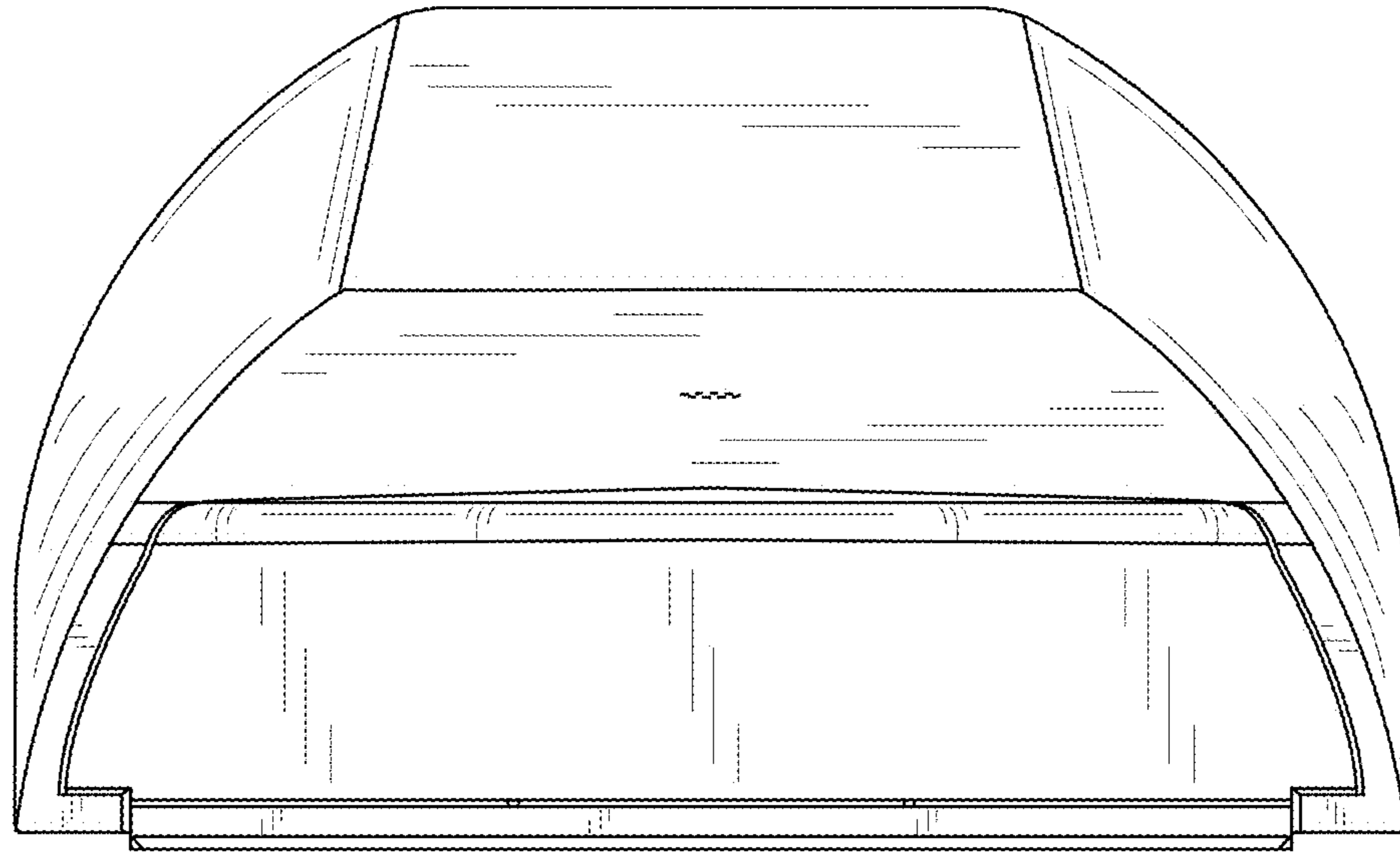

FIG. 6

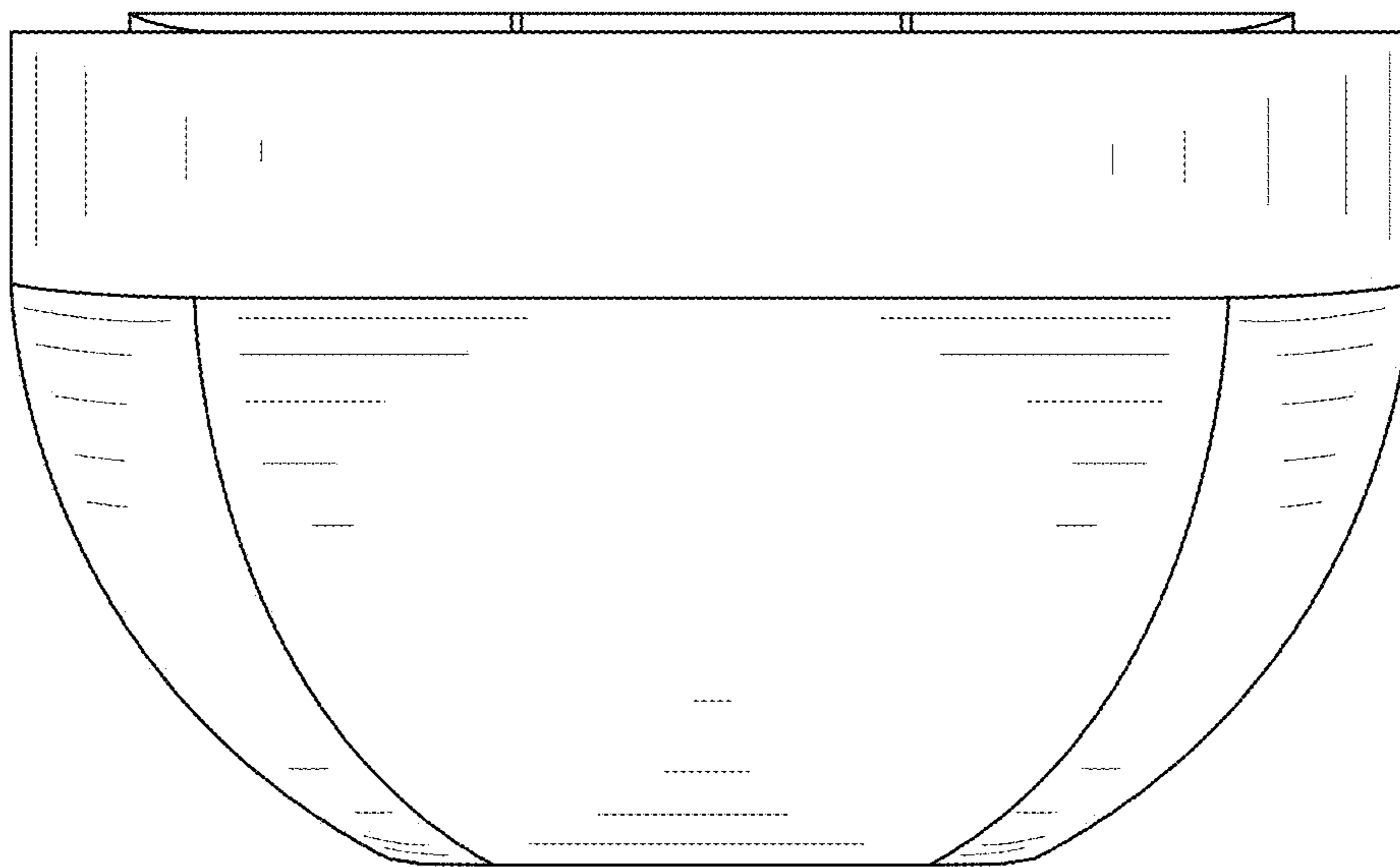

FIG. 7