



US00D752469S

(12) **United States Design Patent**
Rastrick

(10) **Patent No.:** **US D752,469 S**
(45) **Date of Patent:** **** Mar. 29, 2016**

(54) **WRISTBAND WITH REMOVABLE CONTAINER**

(71) Applicant: **Miranda Rastrick**, Eastleigh (GB)

(72) Inventor: **Miranda Rastrick**, Eastleigh (GB)

(**) Term: **14 Years**

(21) Appl. No.: **29/500,086**

(22) Filed: **Aug. 21, 2014**

(30) **Foreign Application Priority Data**

Feb. 21, 2014 (EM) 002410191

(51) **LOC (10) Cl.** **11-01**

(52) **U.S. Cl.**
USPC **D11/3**

(58) **Field of Classification Search**

USPC D11/3-4; D3/215; 224/219, 222, 267,
224/269; 63/3, 1.14

See application file for complete search history.

(56) **References Cited**

U.S. PATENT DOCUMENTS

2,449,324 A * 9/1948 Robinson A45C 1/04
224/219

2,473,226 A * 6/1949 Sheldon G04B 37/12
224/219

3,009,614 A * 11/1961 Humphner A44C 5/003
224/219

3,157,326 A * 11/1964 Murphy A44C 5/003
224/219

4,502,298 A * 3/1985 Benton A44C 5/003
224/219

D524,678 S * 7/2006 Fishman D11/2

7,942,293 B2 * 5/2011 Lawrence A45C 11/008
224/197

D688,968 S * 9/2013 Guerrero, II D11/3

8,651,346 B1 * 2/2014 Williams A44C 5/003
224/219

D720,641 S * 1/2015 Rummonds D11/3

8,950,632 B2 * 2/2015 Ciavarella A44C 5/0023
224/219

D735,068 S * 7/2015 Garcia Pla D11/3

* cited by examiner

Primary Examiner — Catheri Oliver-Garcia

(74) *Attorney, Agent, or Firm* — Muncy, Geissler, Olds & Lowe, P.C.

(57) **CLAIM**

The ornamental design for a wristband with removable container, as shown and described.

DESCRIPTION

FIG. 1 is a top plan view of a wristband with removable container showing my new design, with the lid of the removable container in a closed position;

FIG. 2 is a front elevational view thereof;

FIG. 3 is a left side view thereof;

FIG. 4 is a right side view thereof;

FIG. 5 is a rear elevational view thereof;

FIG. 6 is a bottom plan view thereof;

FIG. 7 is a top, left, front perspective view thereof;

FIG. 8 is a left, rear perspective view thereof;

FIG. 9 is a right, front perspective view thereof;

FIG. 10 is a bottom, left, front perspective view thereof;

FIG. 11 is a top plan view of the removable container, with the lid in a closed position;

FIG. 12 is a front elevational view thereof;

FIG. 13 is a left side view thereof;

FIG. 14 is a rear elevational view thereof;

FIG. 15 is a bottom plan view thereof;

FIG. 16 is a top, left, front perspective view thereof;

FIG. 17 is a top, left, rear perspective view thereof;

FIG. 18 is a bottom, left, rear perspective view thereof;

FIG. 19 is a bottom, left, front perspective view thereof;

FIG. 20 is a top plan view of a wristband with removable container showing my new design, with the lid of the removable container in an open position;

FIG. 21 is a front elevational view thereof;

FIG. 22 is a left side view thereof;

FIG. 23 is a right side view thereof;

FIG. 24 is a rear elevational view thereof;

FIG. 25 is a bottom plan view thereof;

FIG. 26 is a top, left, front perspective view thereof;

FIG. 27 is a left, rear perspective view thereof;

FIG. 28 is a right, front perspective view thereof;

FIG. 29 is a bottom, left, front perspective view thereof;

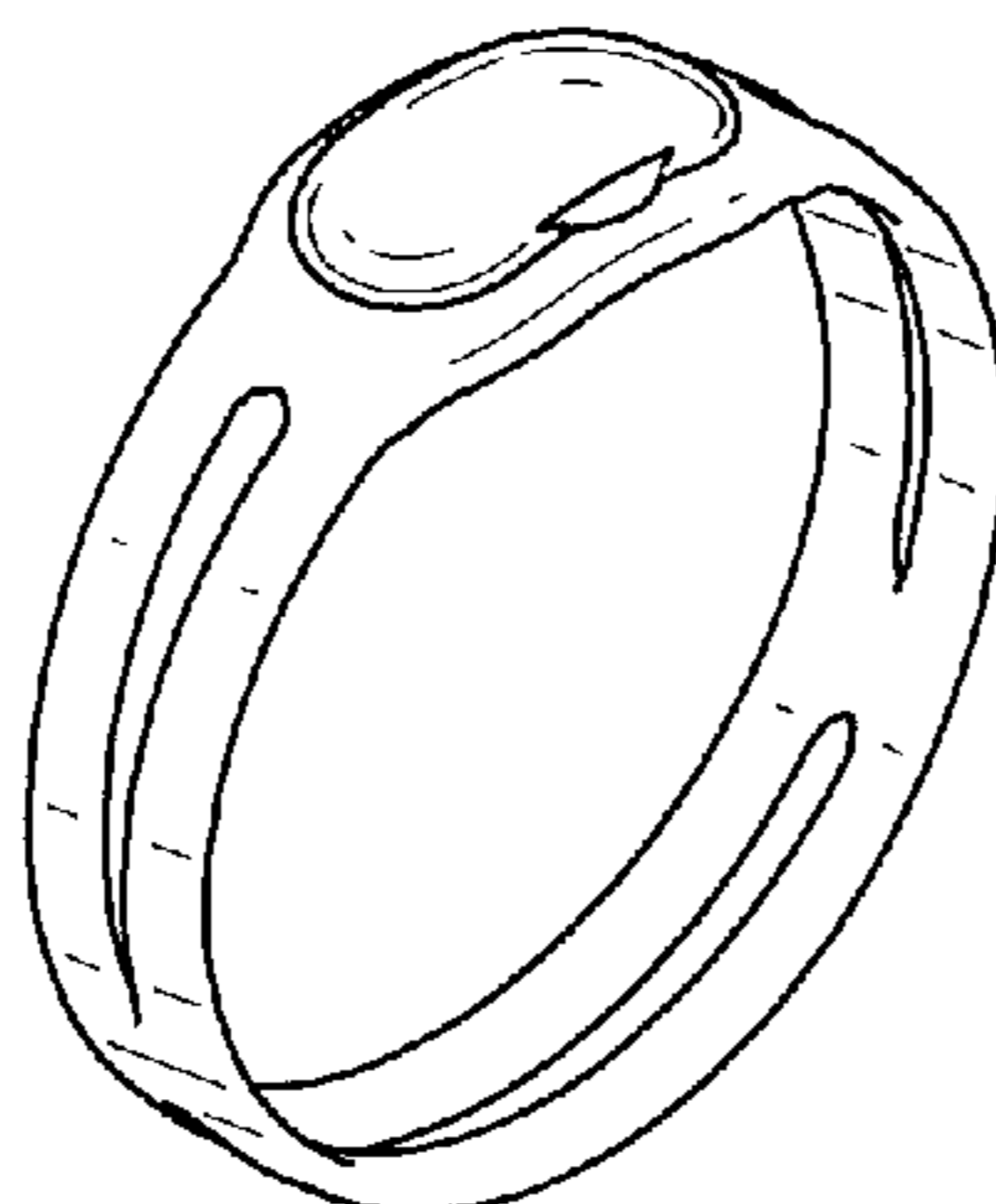

FIG. 30 is a top plan view of the removable container, with the lid in an open position;
FIG. 31 is a rear elevational view thereof;
FIG. 32 is a left side view thereof;
FIG. 33 is a front elevational view thereof;
FIG. 34 is a bottom plan view thereof;
FIG. 35 is a top, left, front perspective view thereof;
FIG. 36 is a top, left, rear perspective view thereof;
FIG. 37 is a bottom, left, rear perspective view thereof;
FIG. 38 is a bottom, left, front perspective view thereof;
FIG. 39 is a top plan view of the wristband with removable container, with the removable container removed;

FIG. 40 is a front elevational view thereof;
FIG. 41 is a left side view thereof;
FIG. 42 is a right side view thereof;
FIG. 43 is a rear elevational view thereof;
FIG. 44 is a bottom plan view thereof; and
FIG. 45 is a top, right, front perspective view thereof;
FIG. 46 is a top, left, front perspective view thereof;
FIG. 47 is a bottom, left, front perspective view thereof; and,
FIG. 48 is a bottom, right, front perspective view thereof.

1 Claim, 10 Drawing Sheets

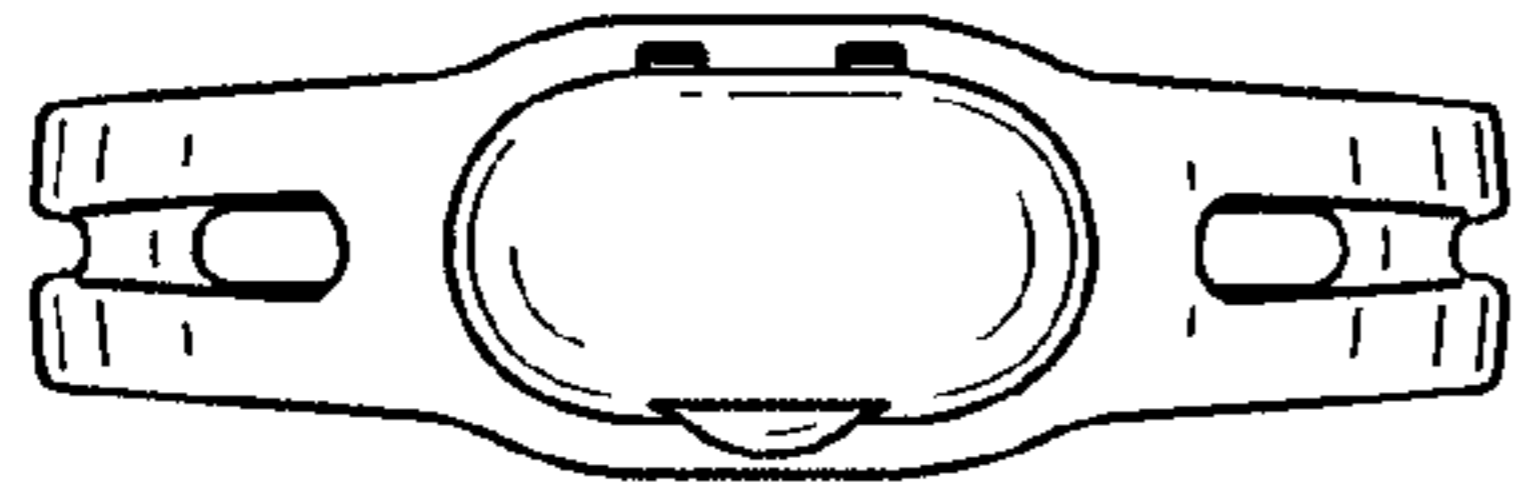

FIG.1

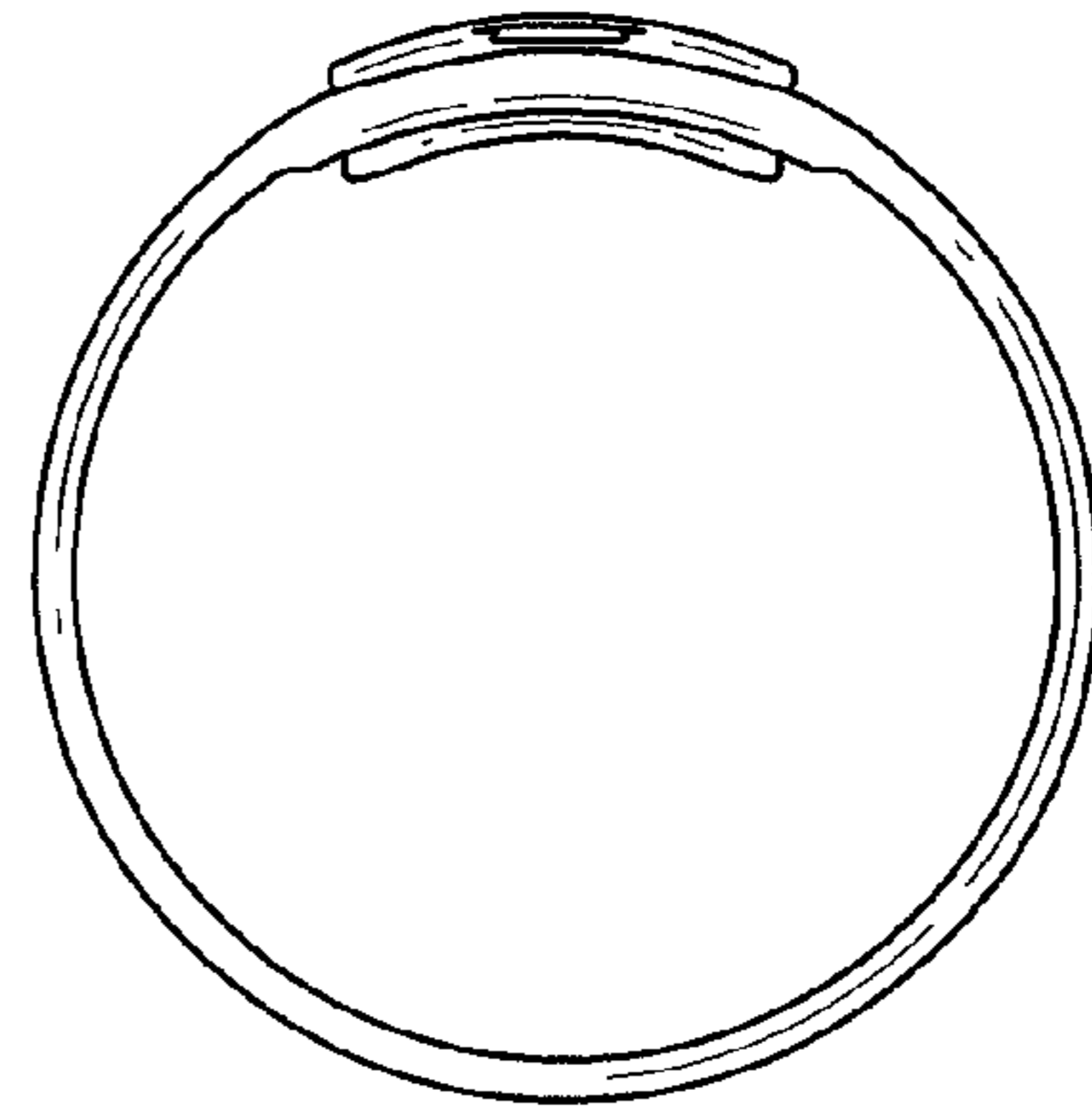

FIG.2

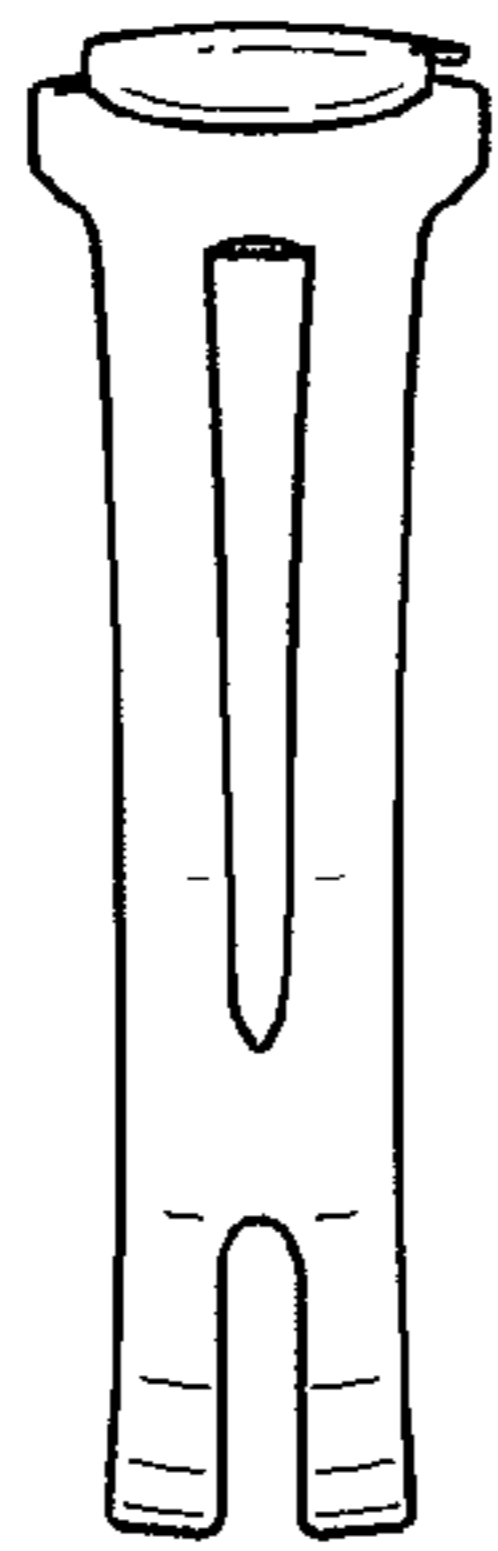

FIG.3

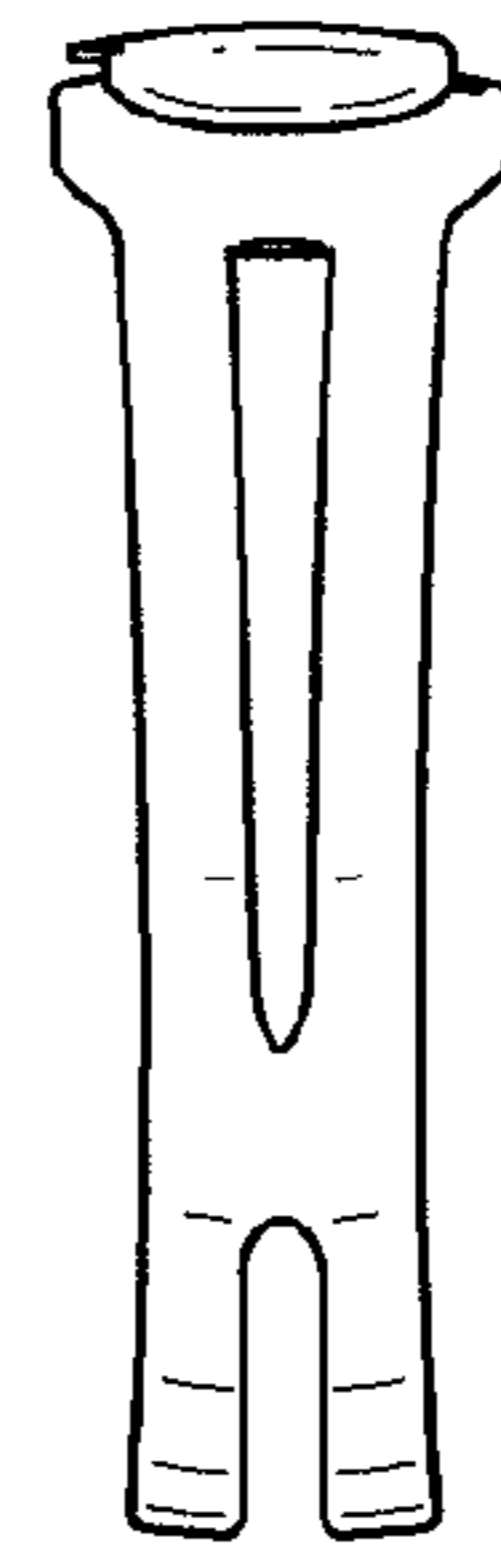

FIG.4

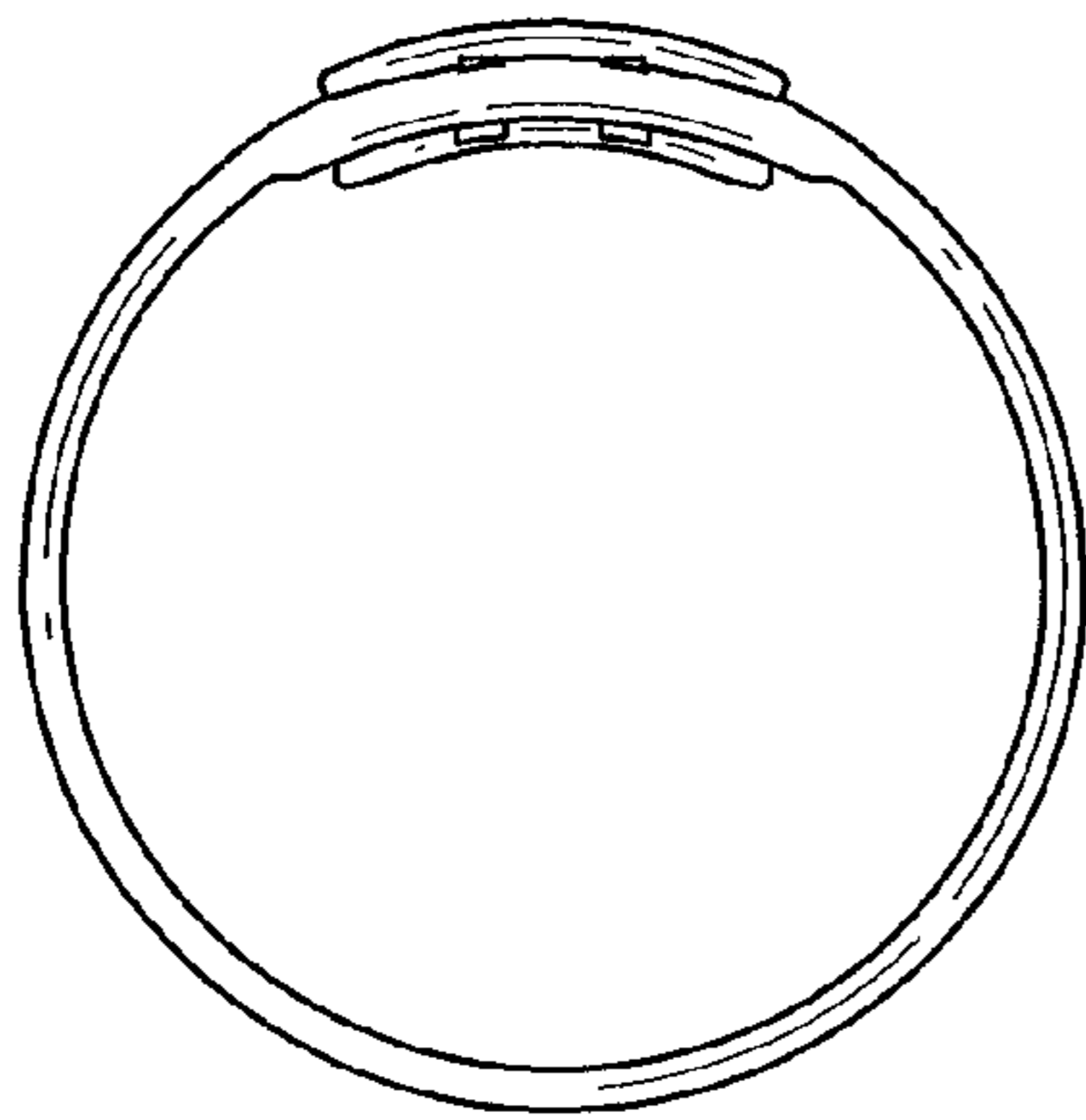

FIG.5

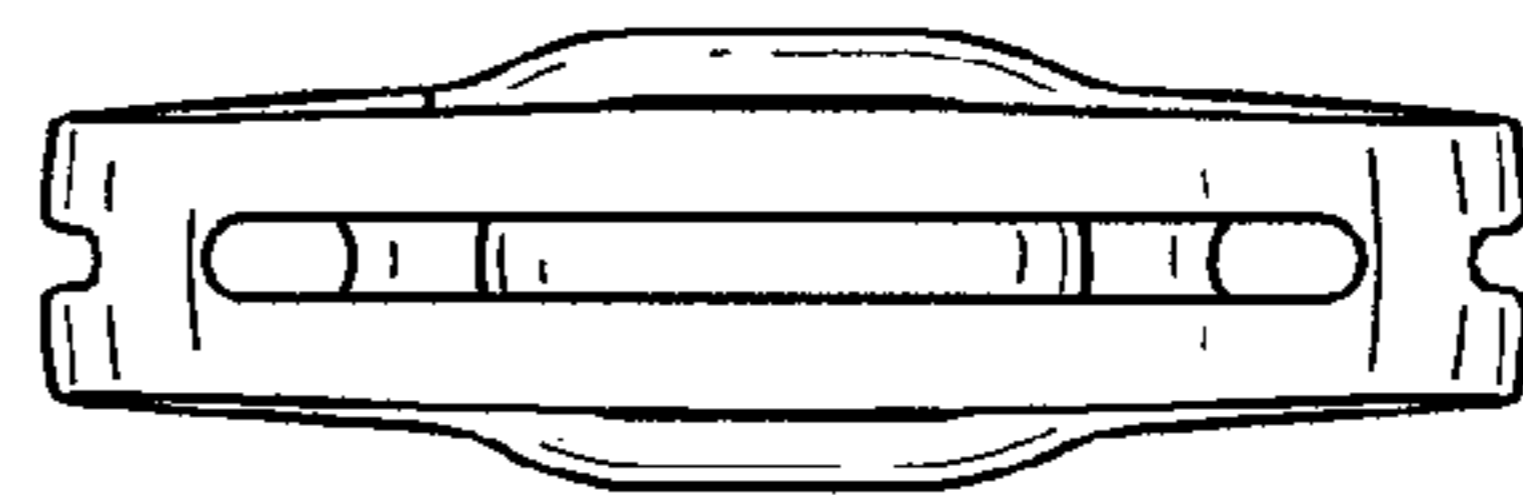

FIG.6

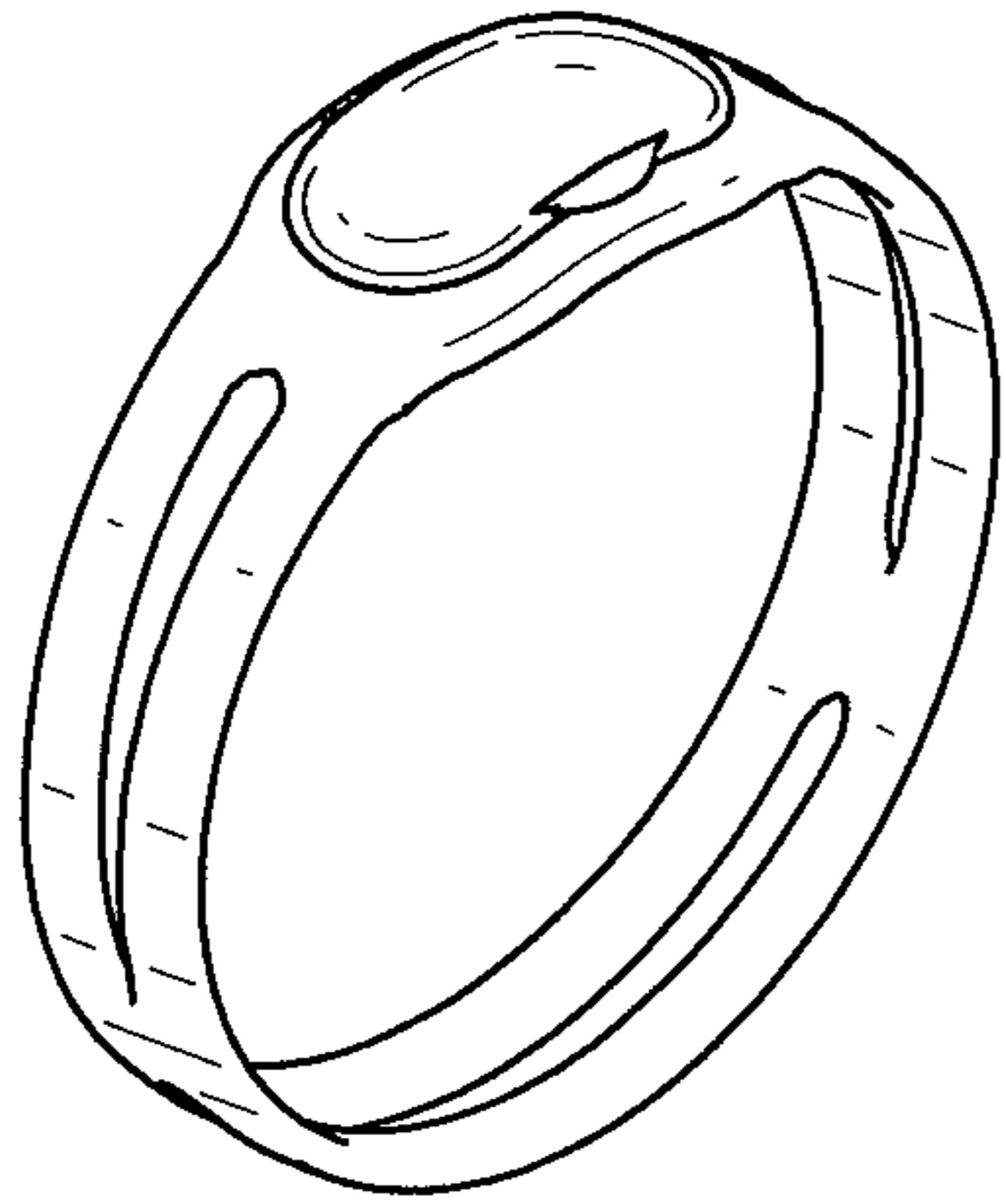

FIG. 7

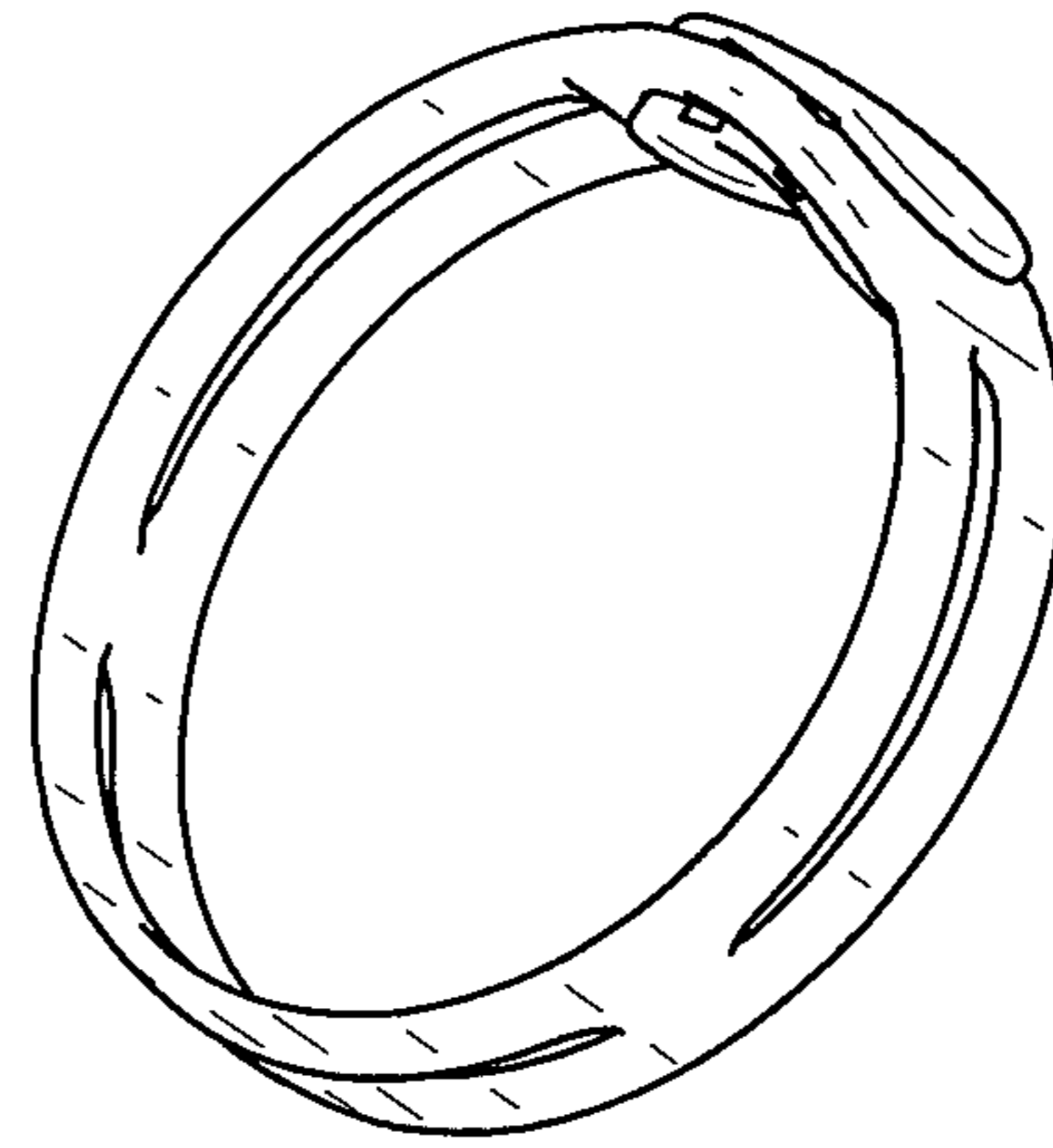

FIG. 8

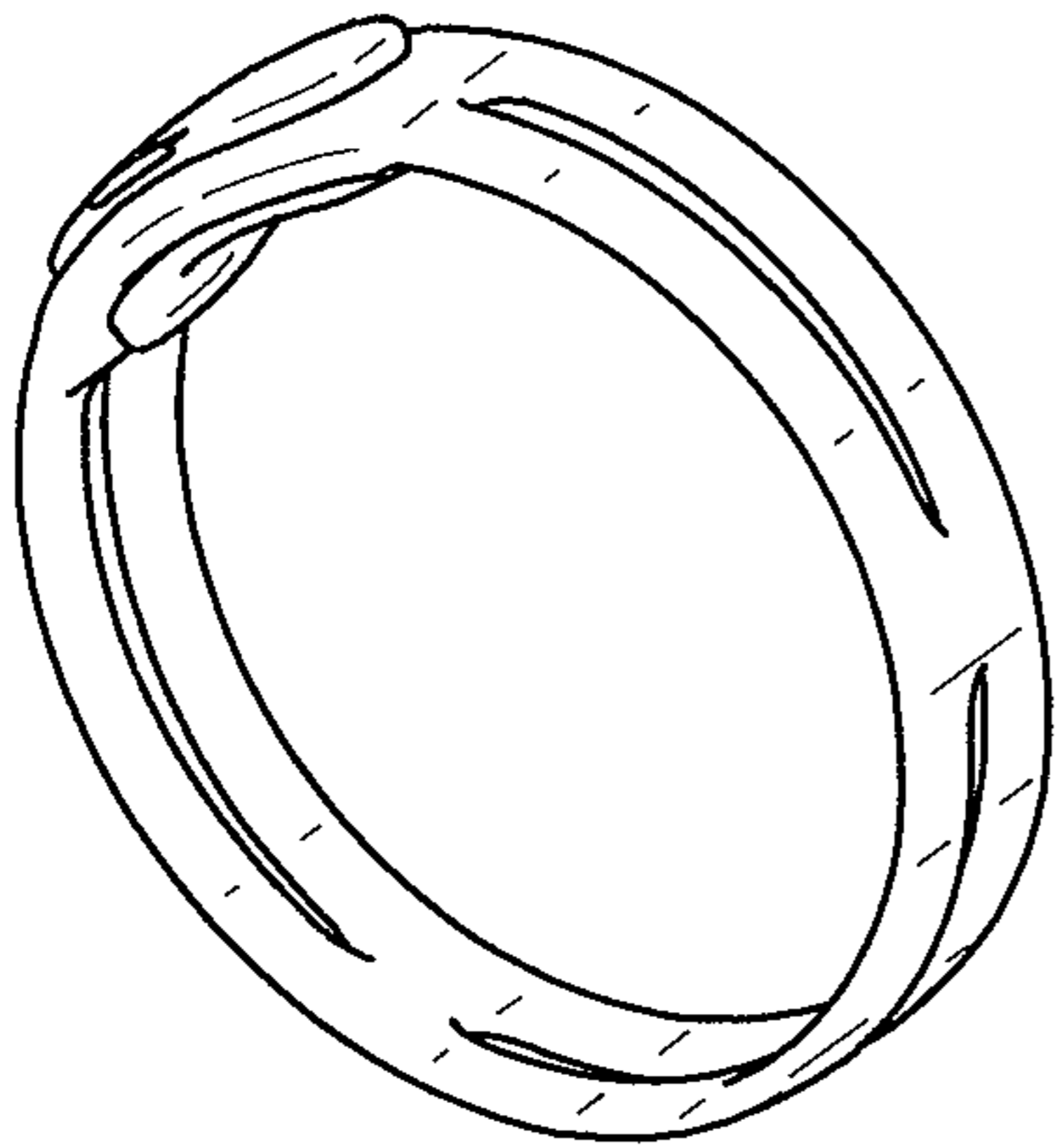

FIG. 9

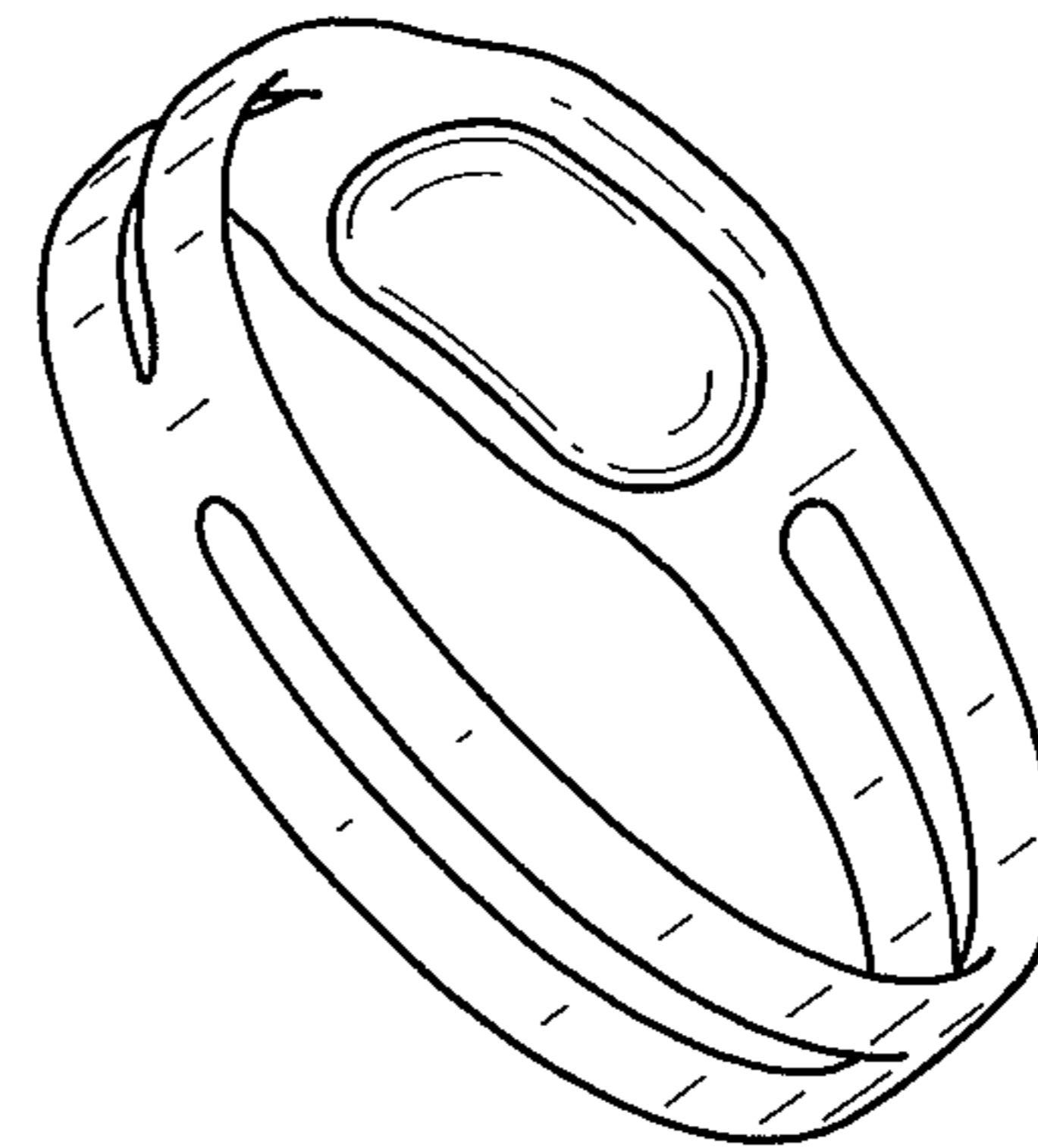

FIG. 10

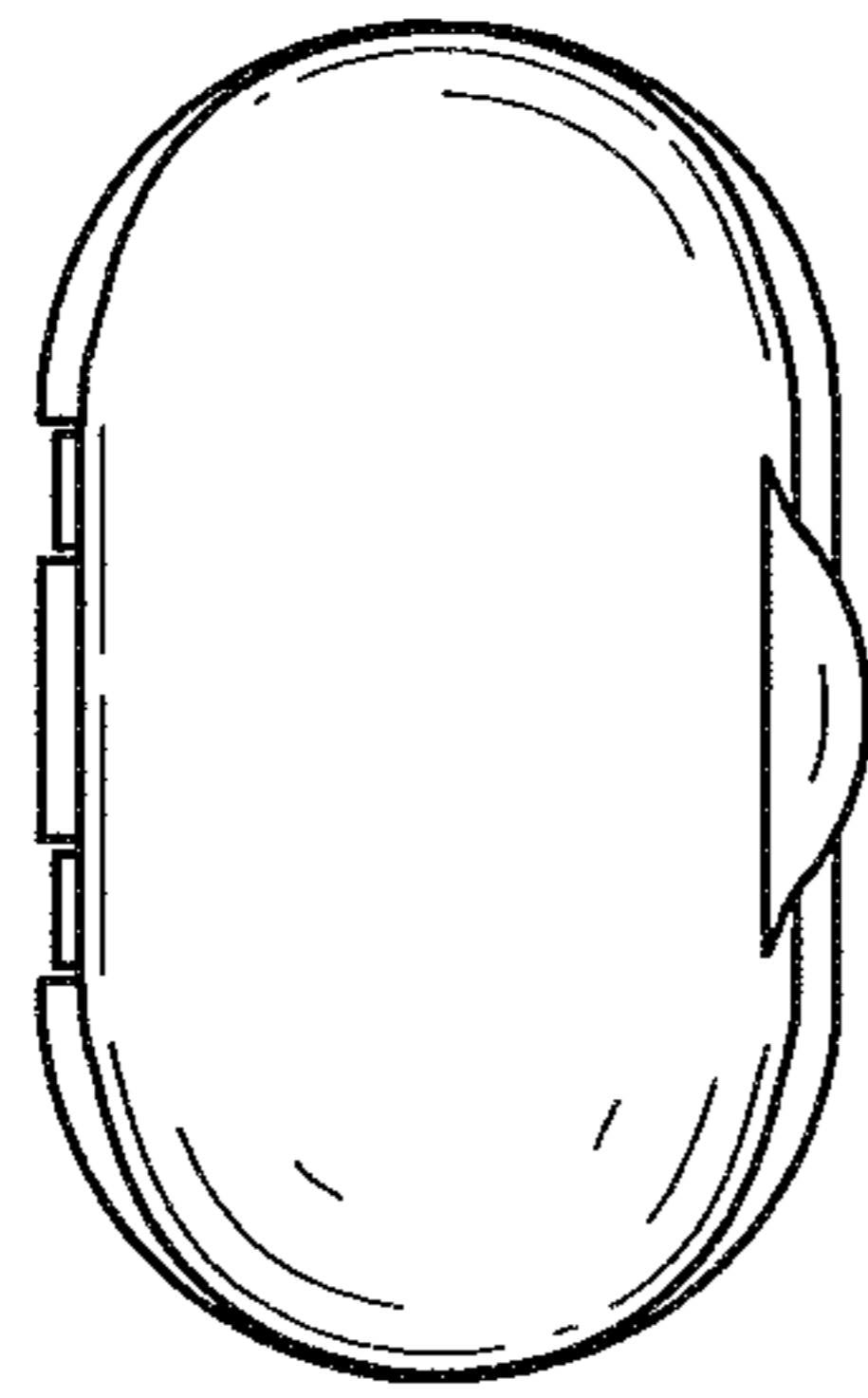

FIG. 11



FIG. 12



FIG. 13

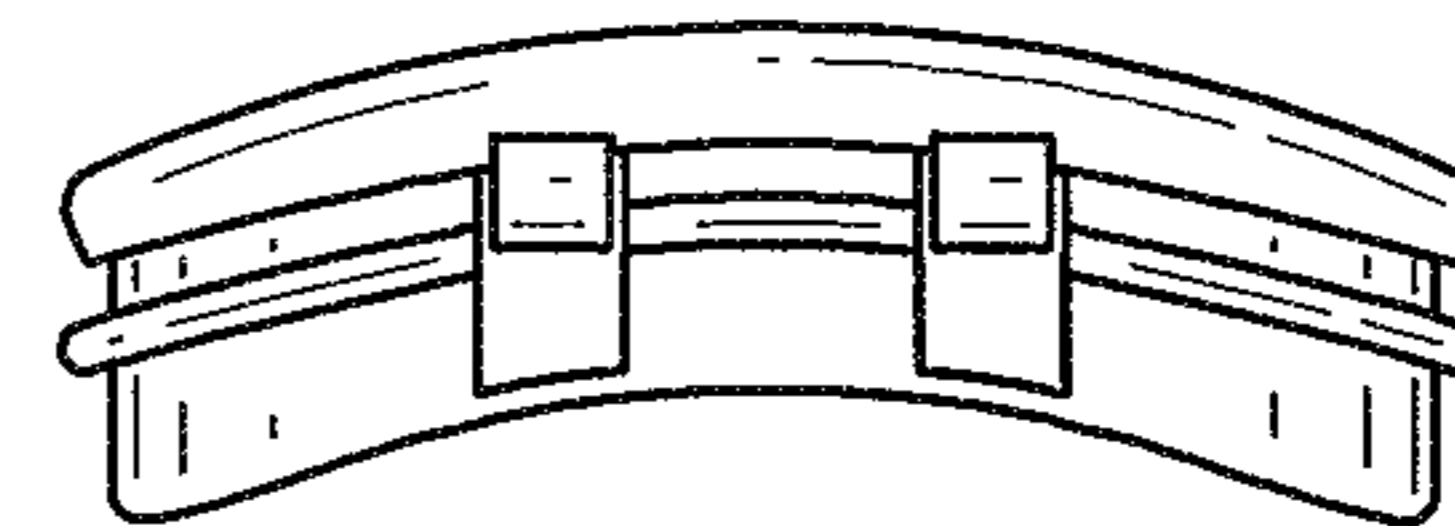

FIG. 14

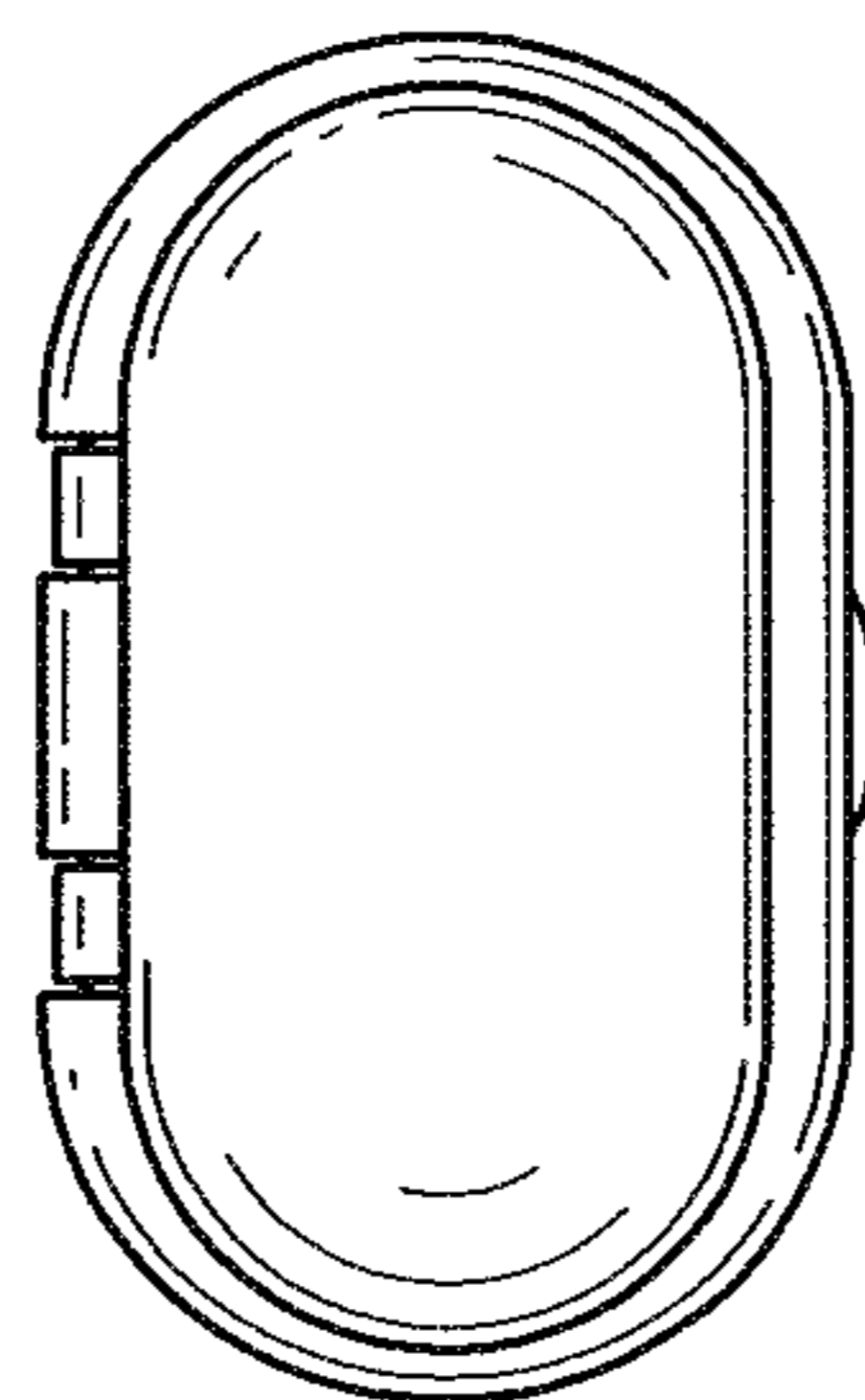

FIG. 15

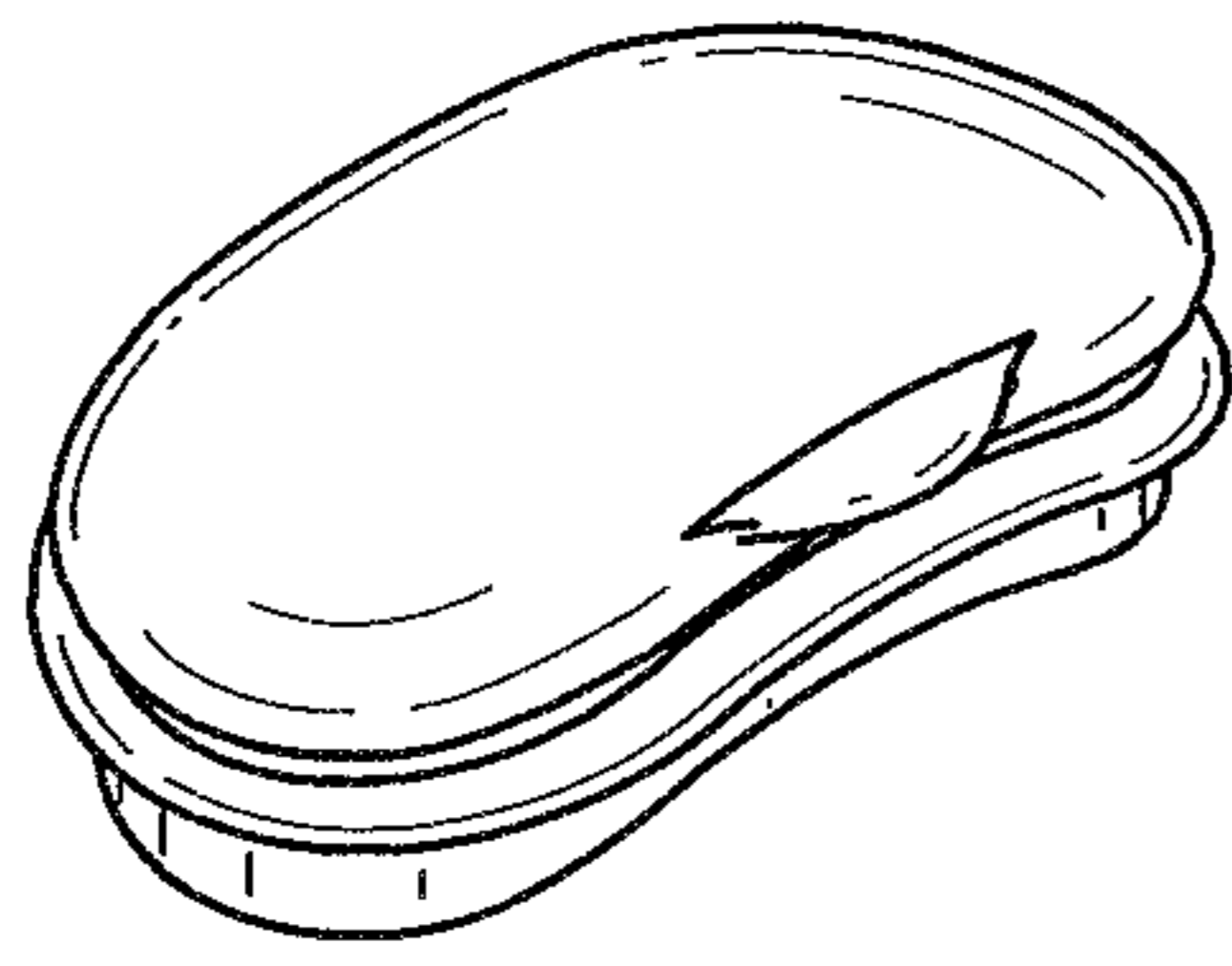

FIG. 16

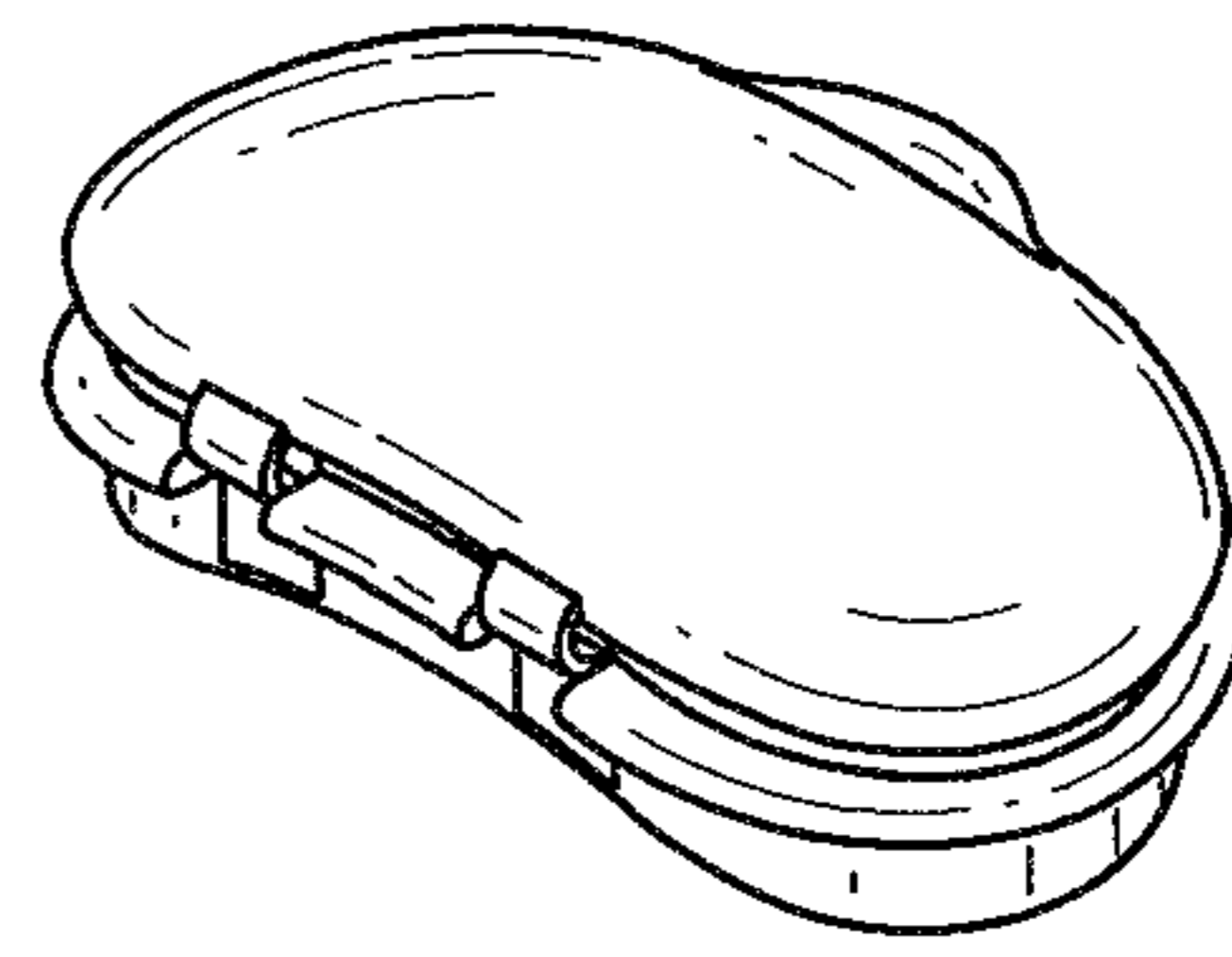

FIG. 17

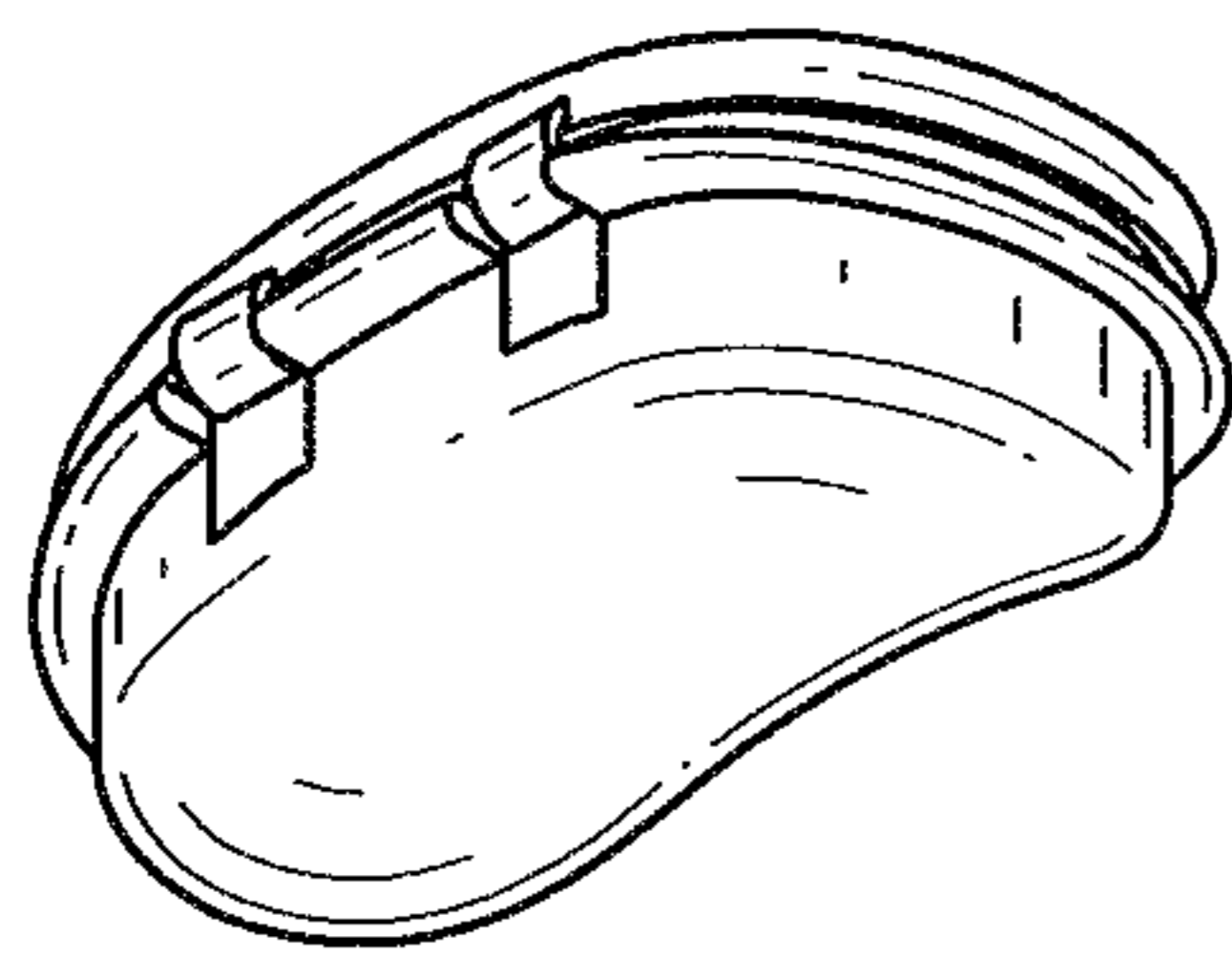

FIG. 18

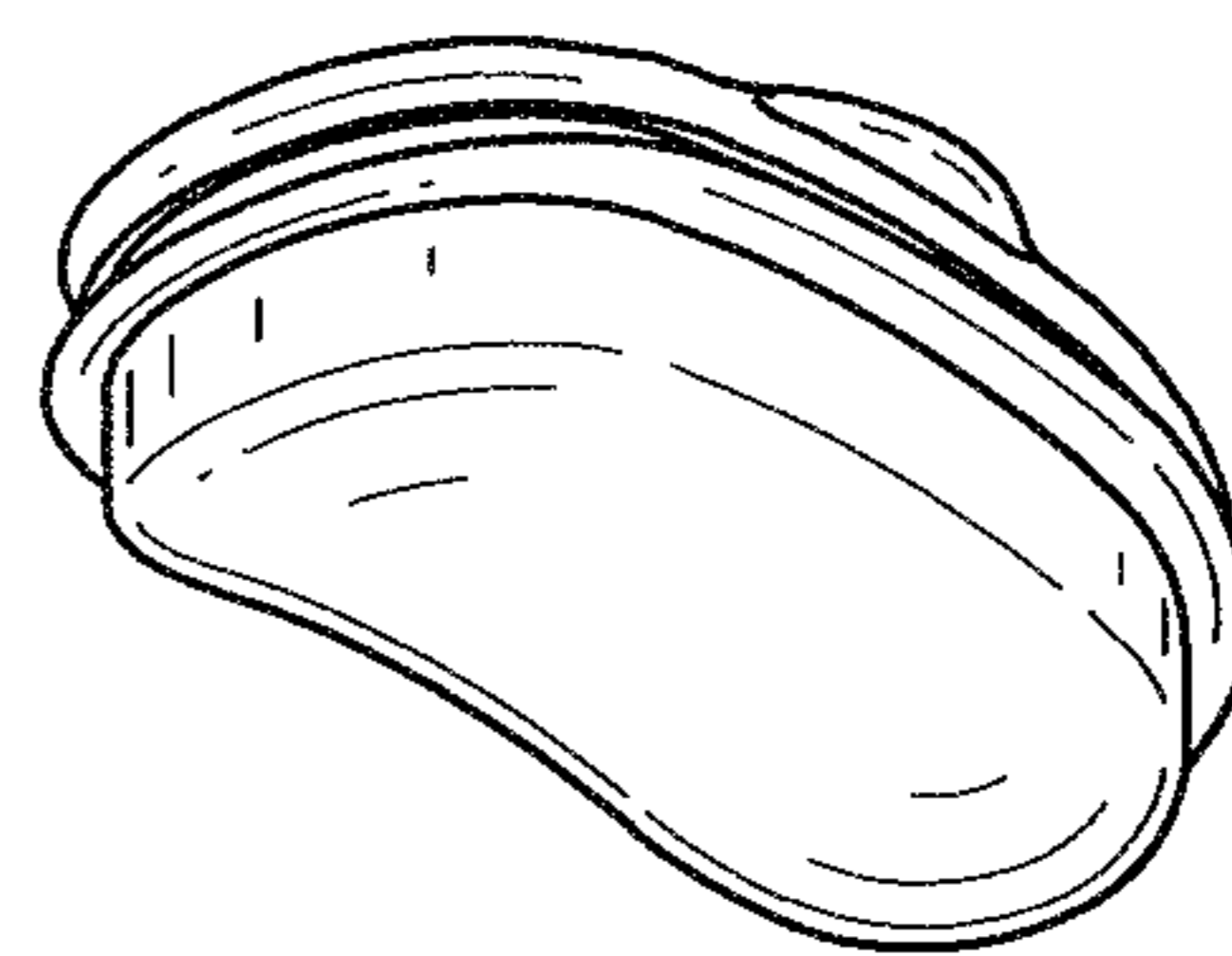

FIG. 19

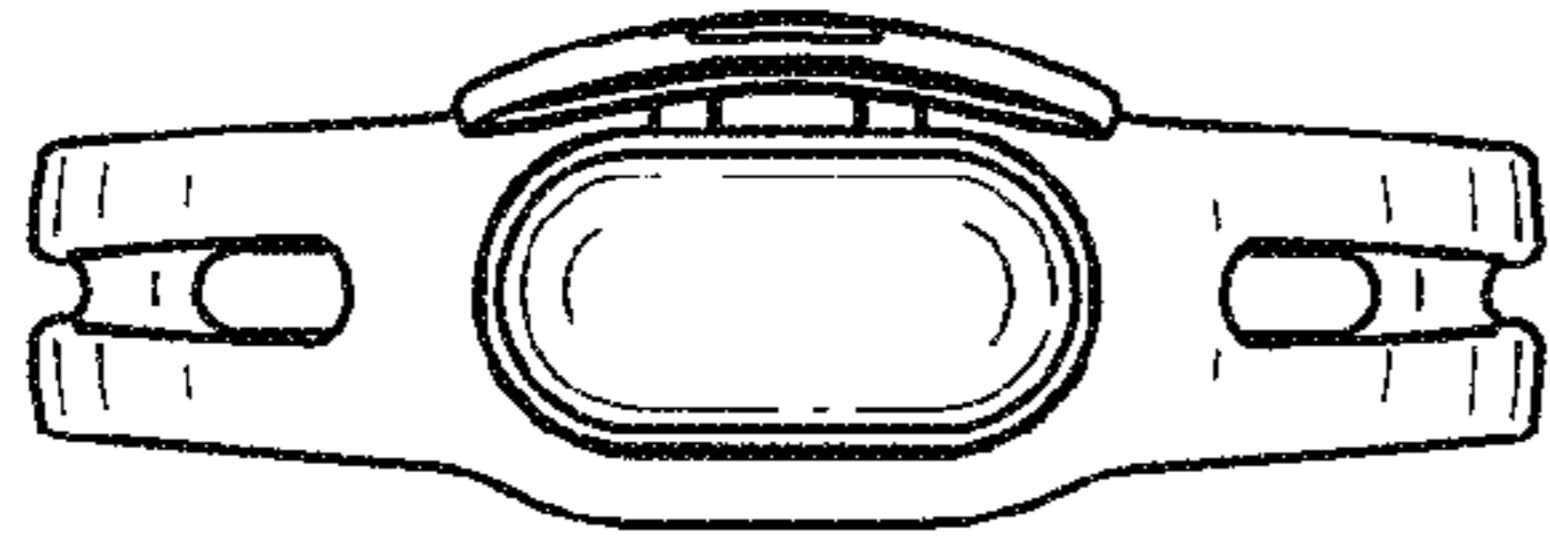

FIG. 20

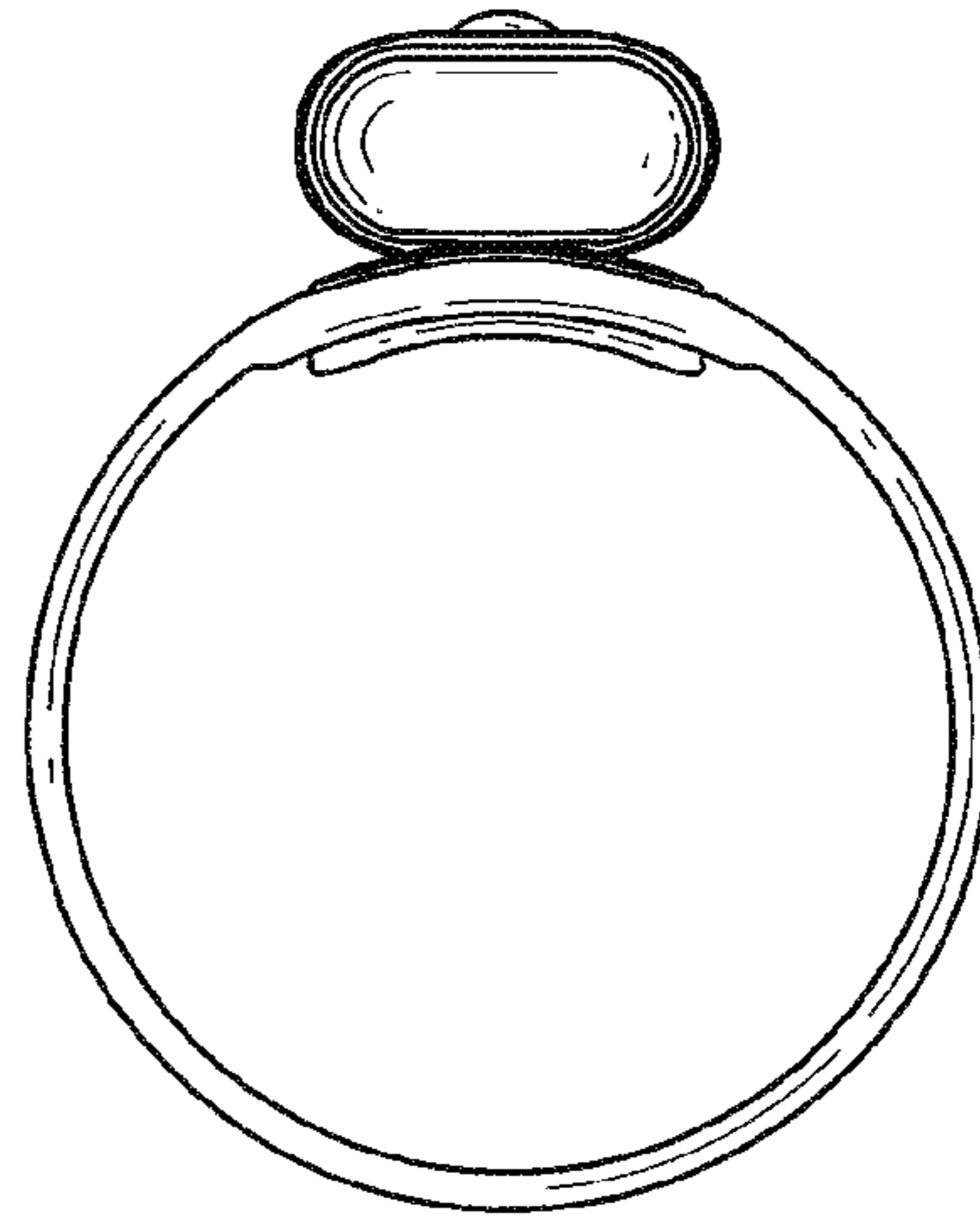

FIG. 21

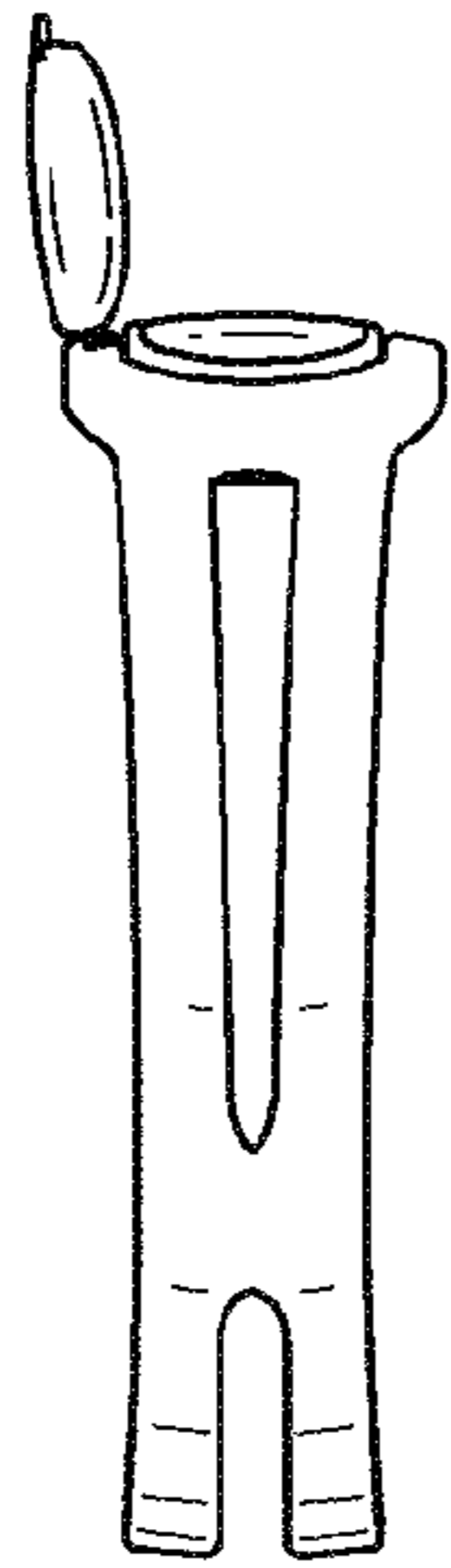

FIG. 22

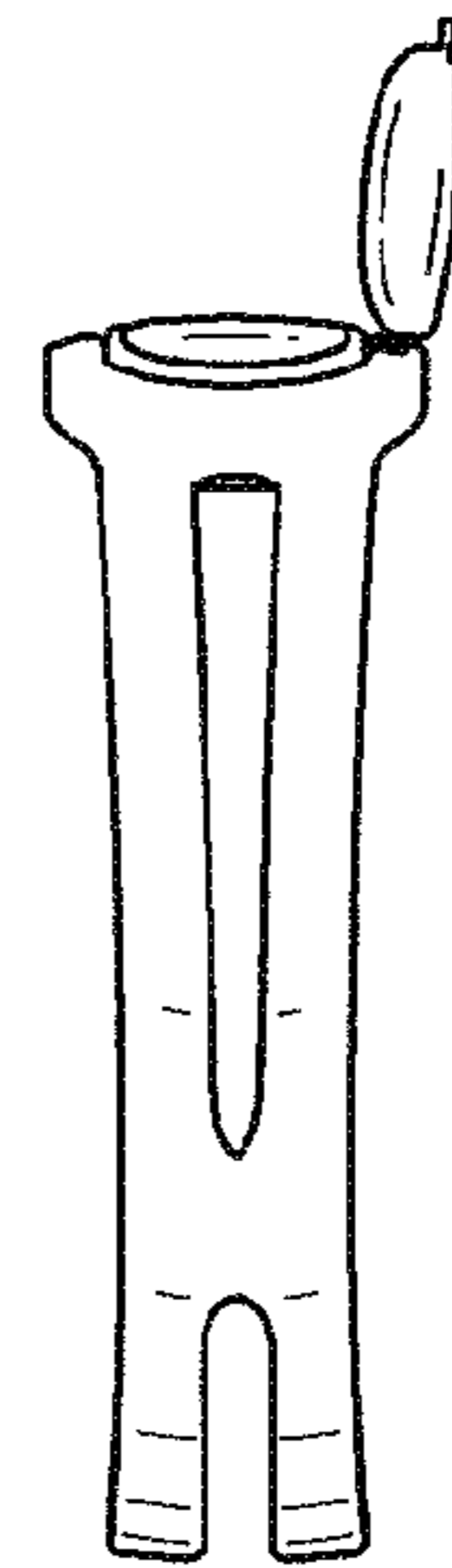

FIG. 23

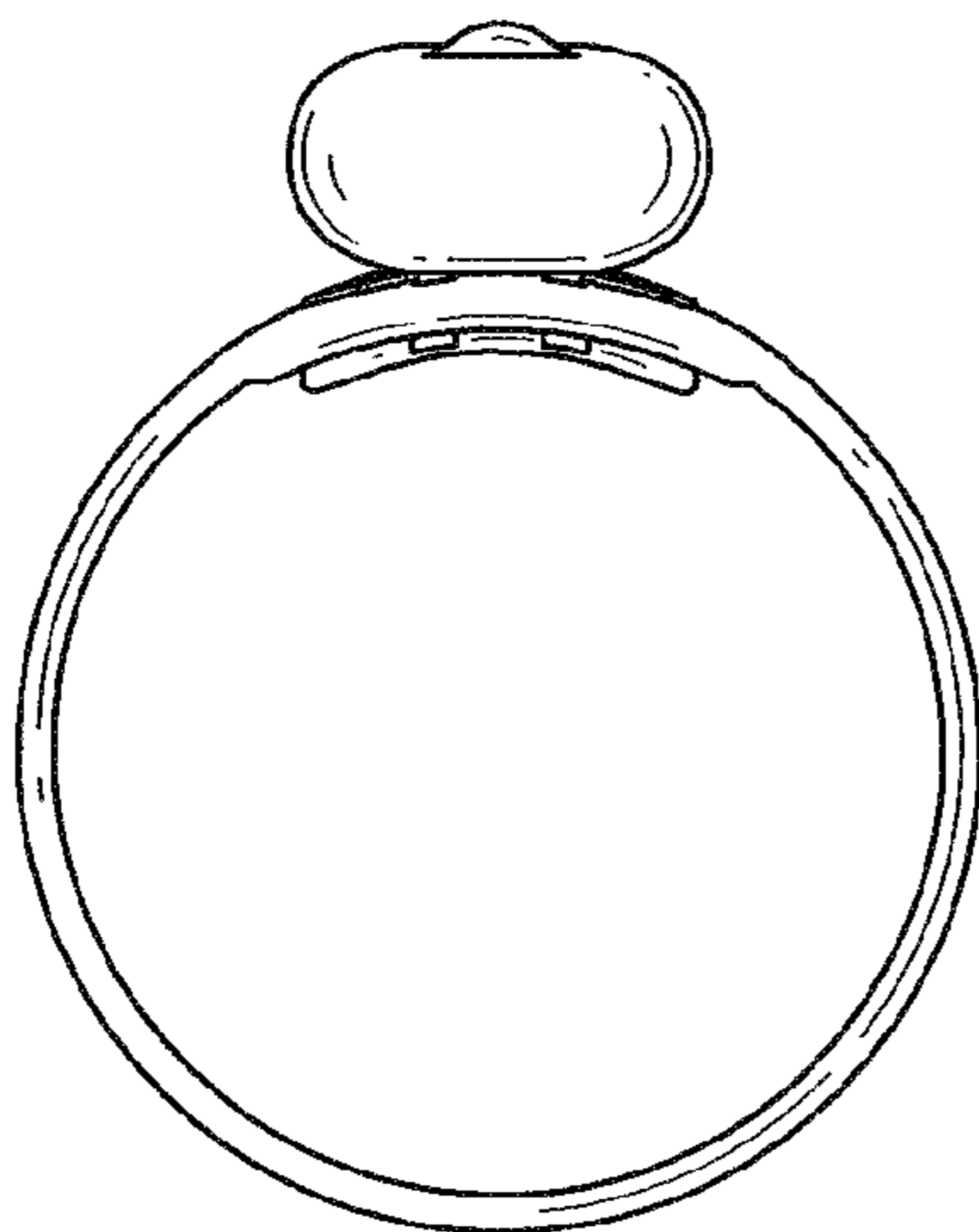

FIG. 24

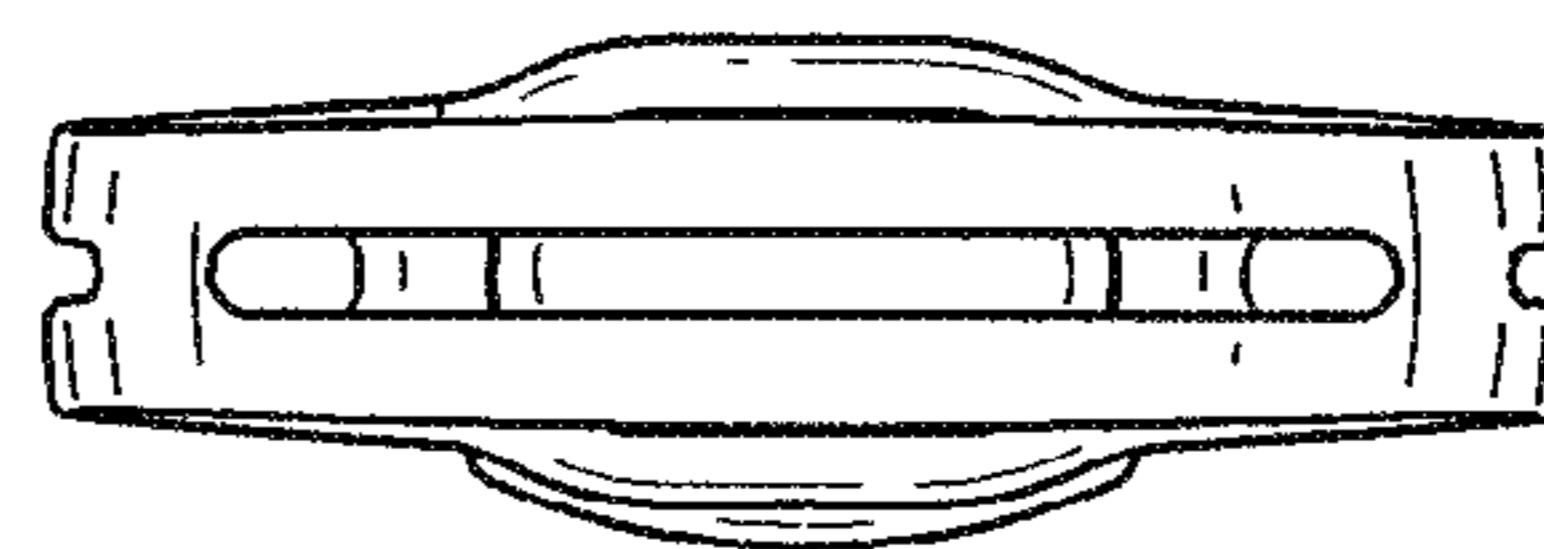

FIG. 25

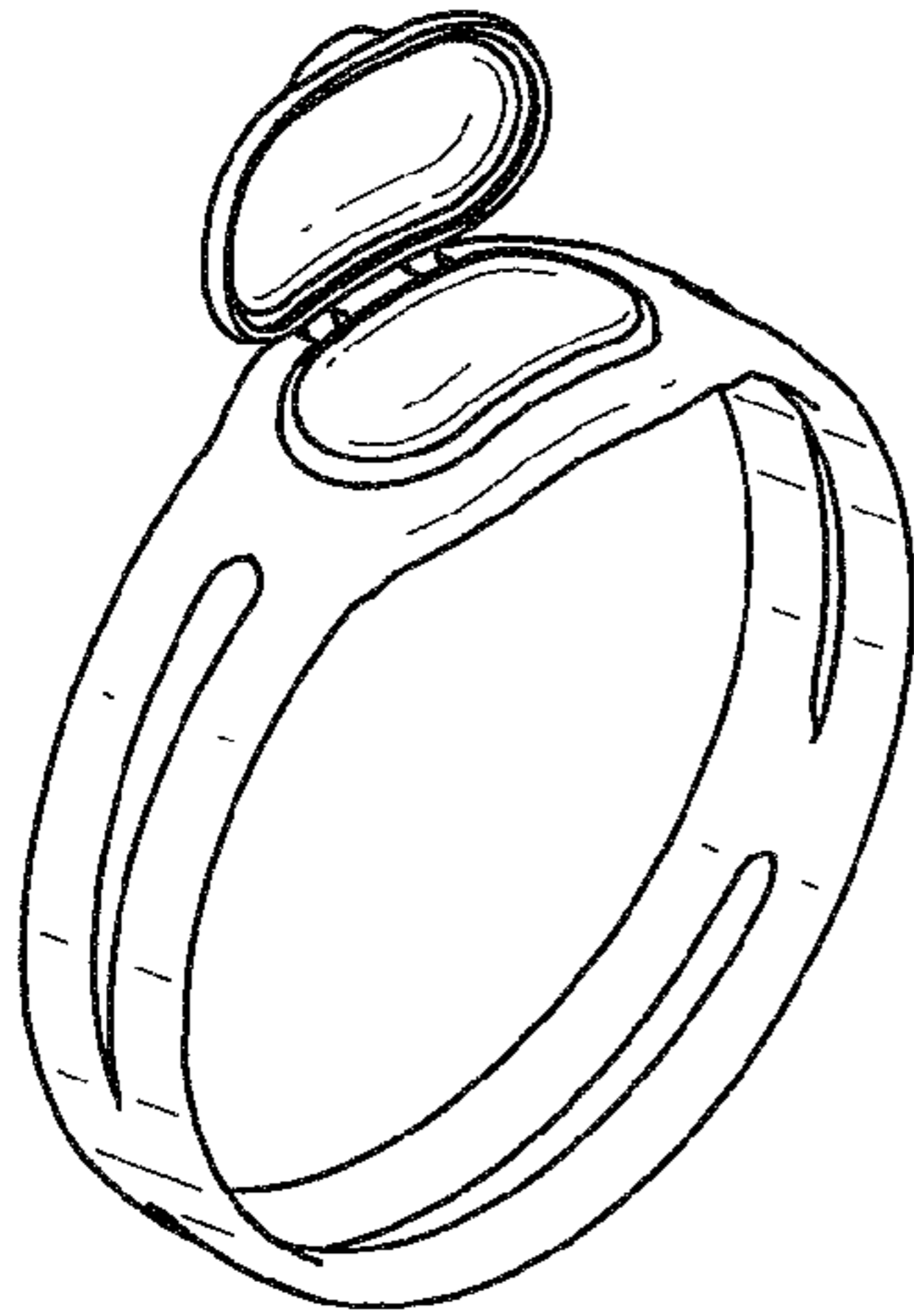

FIG. 26

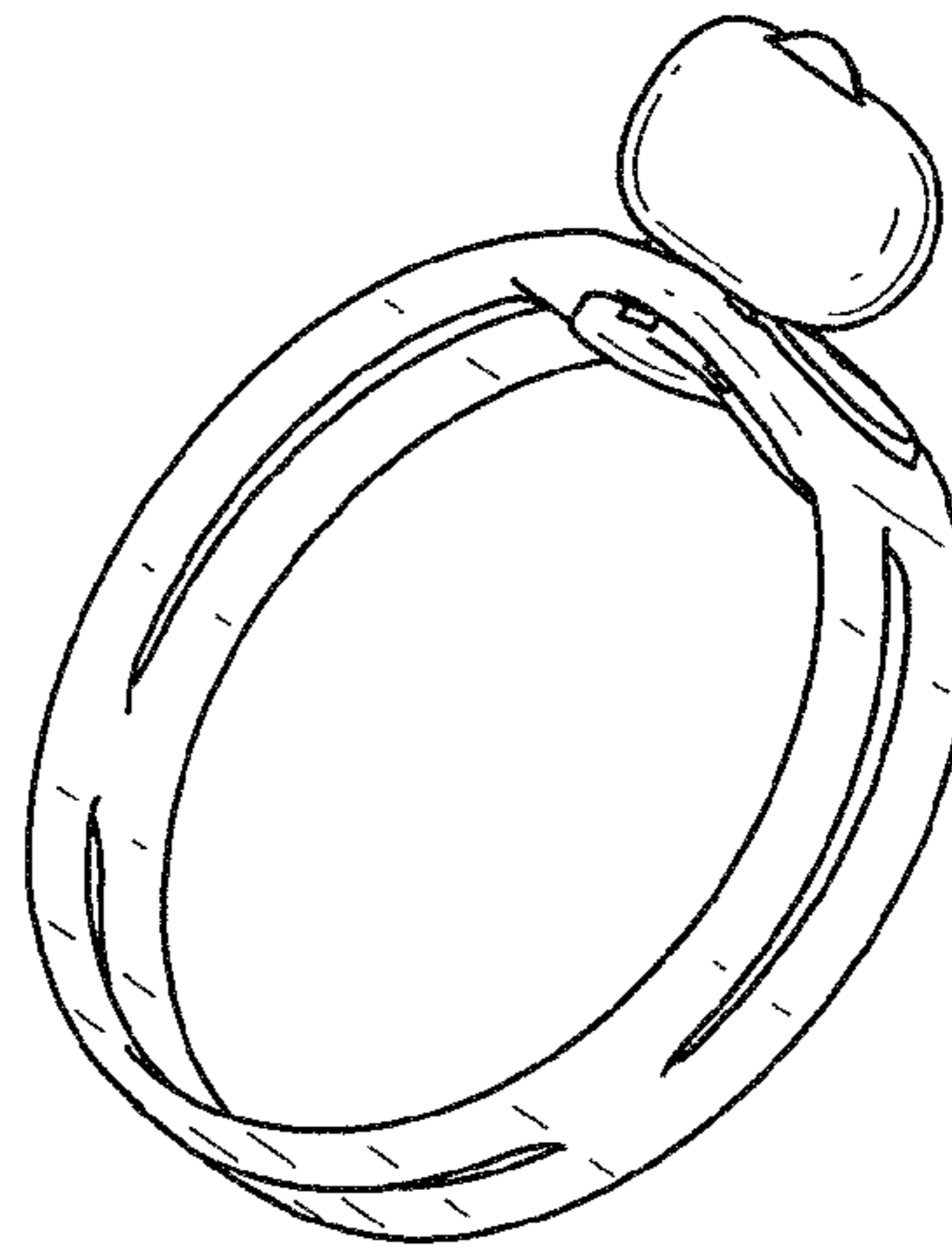

FIG. 27

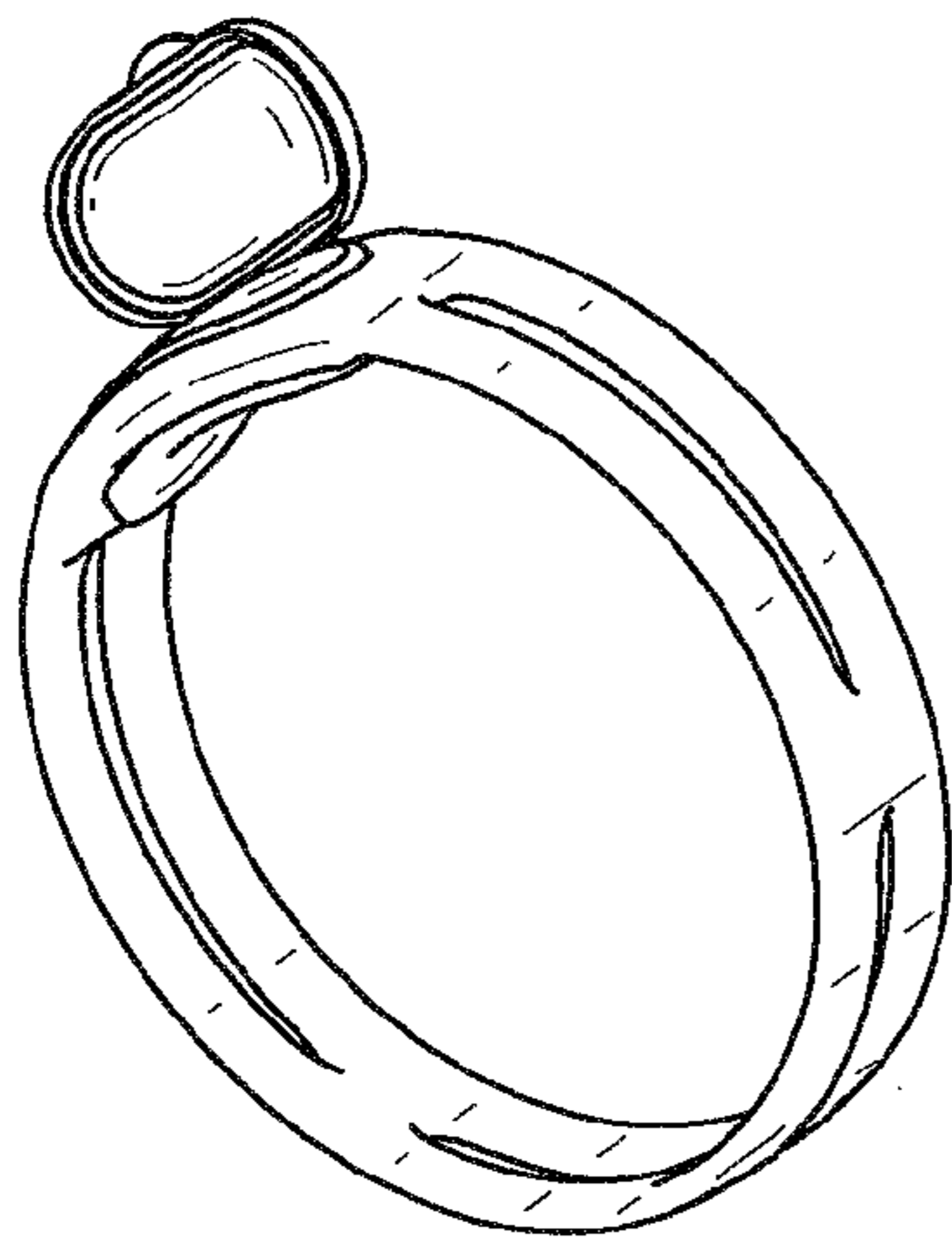

FIG. 28

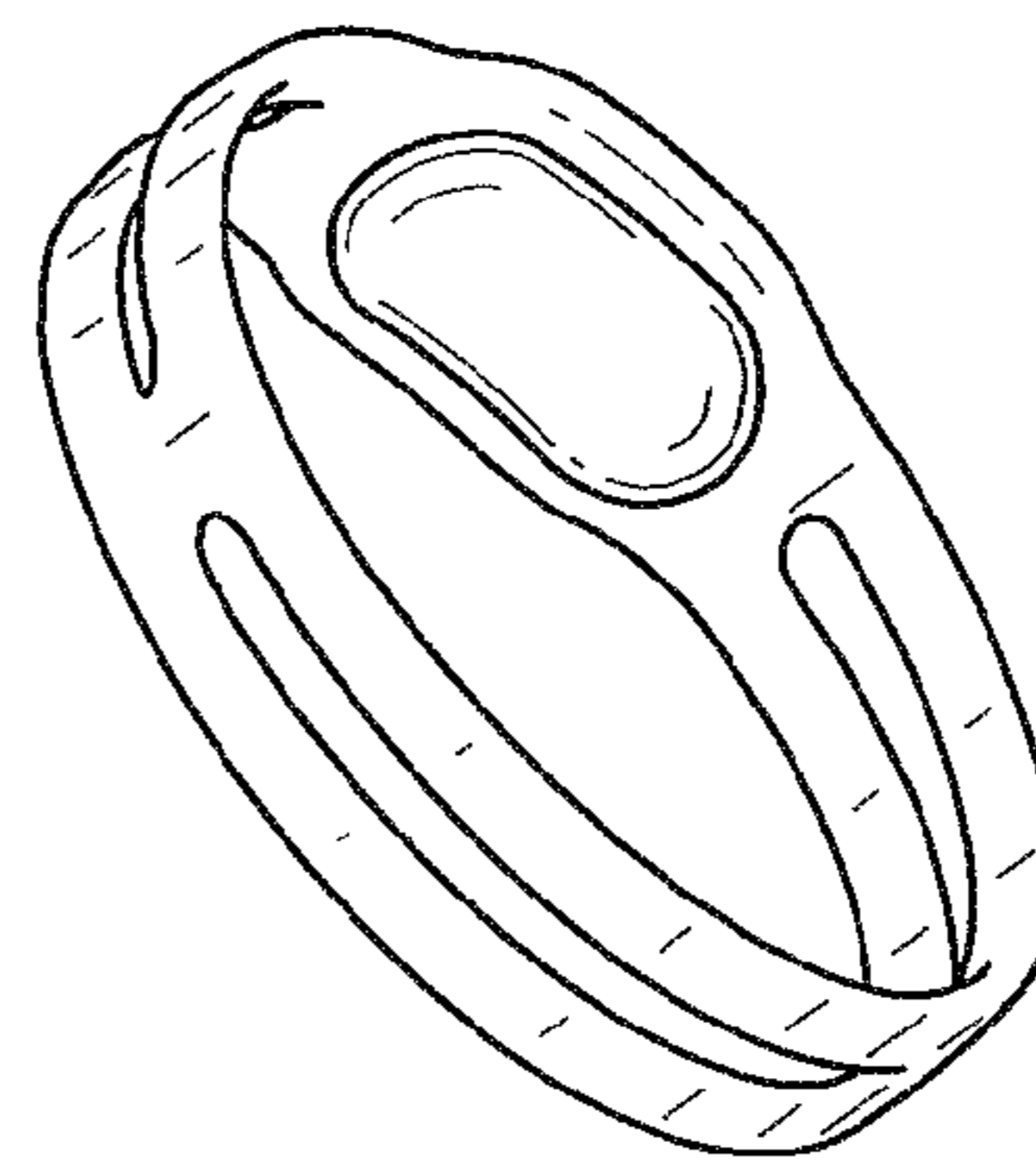

FIG. 29

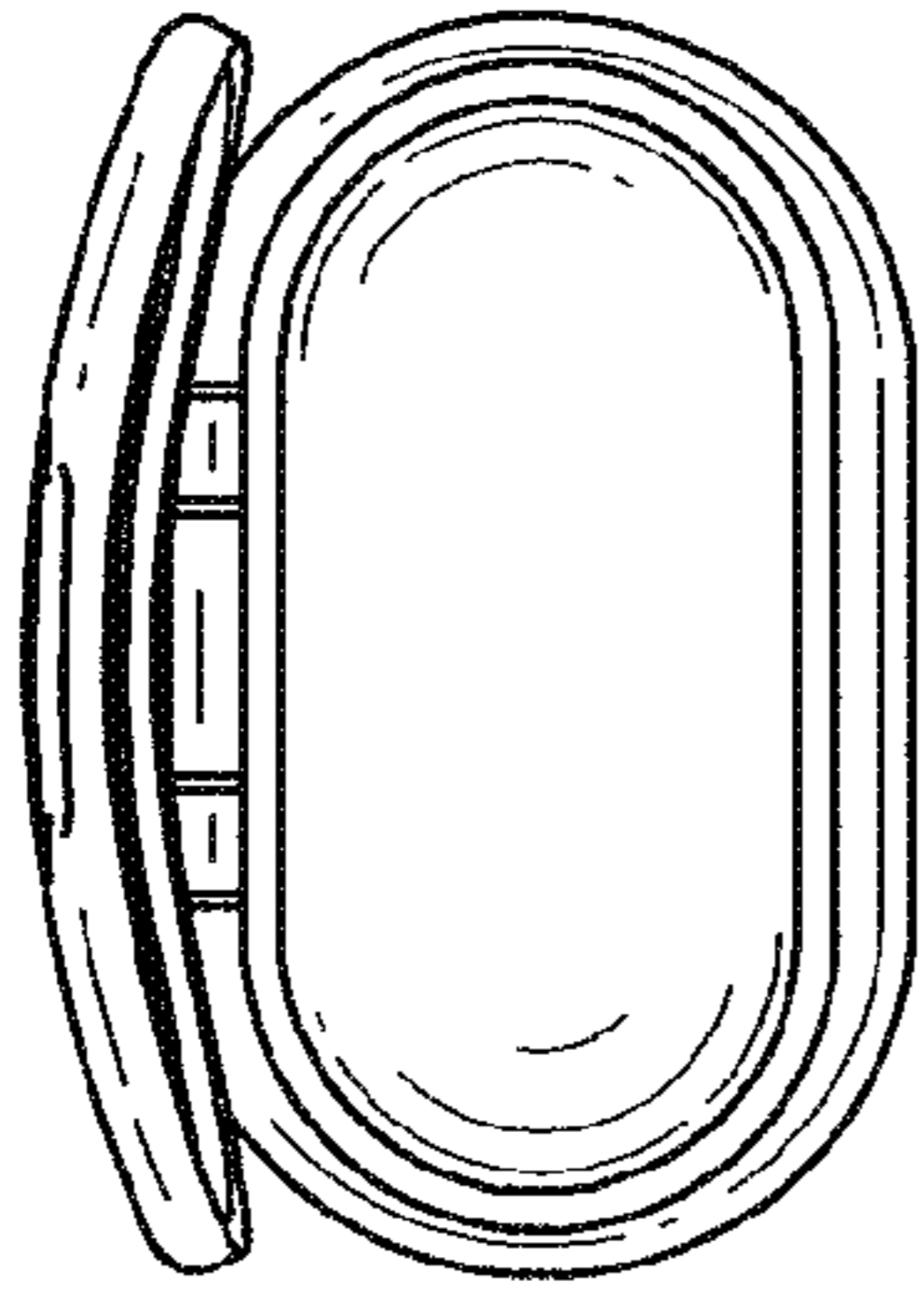

FIG. 30

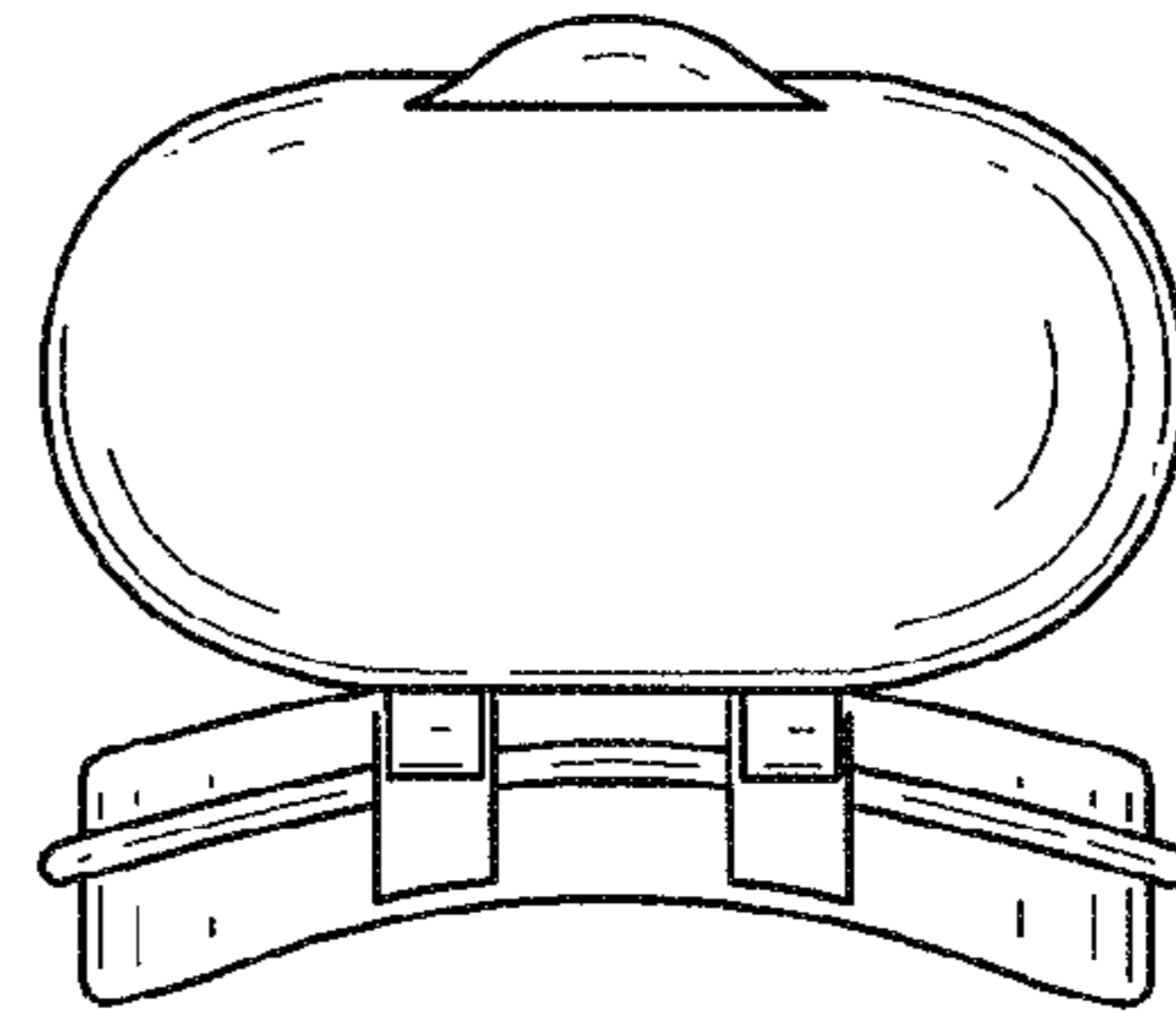

FIG. 31

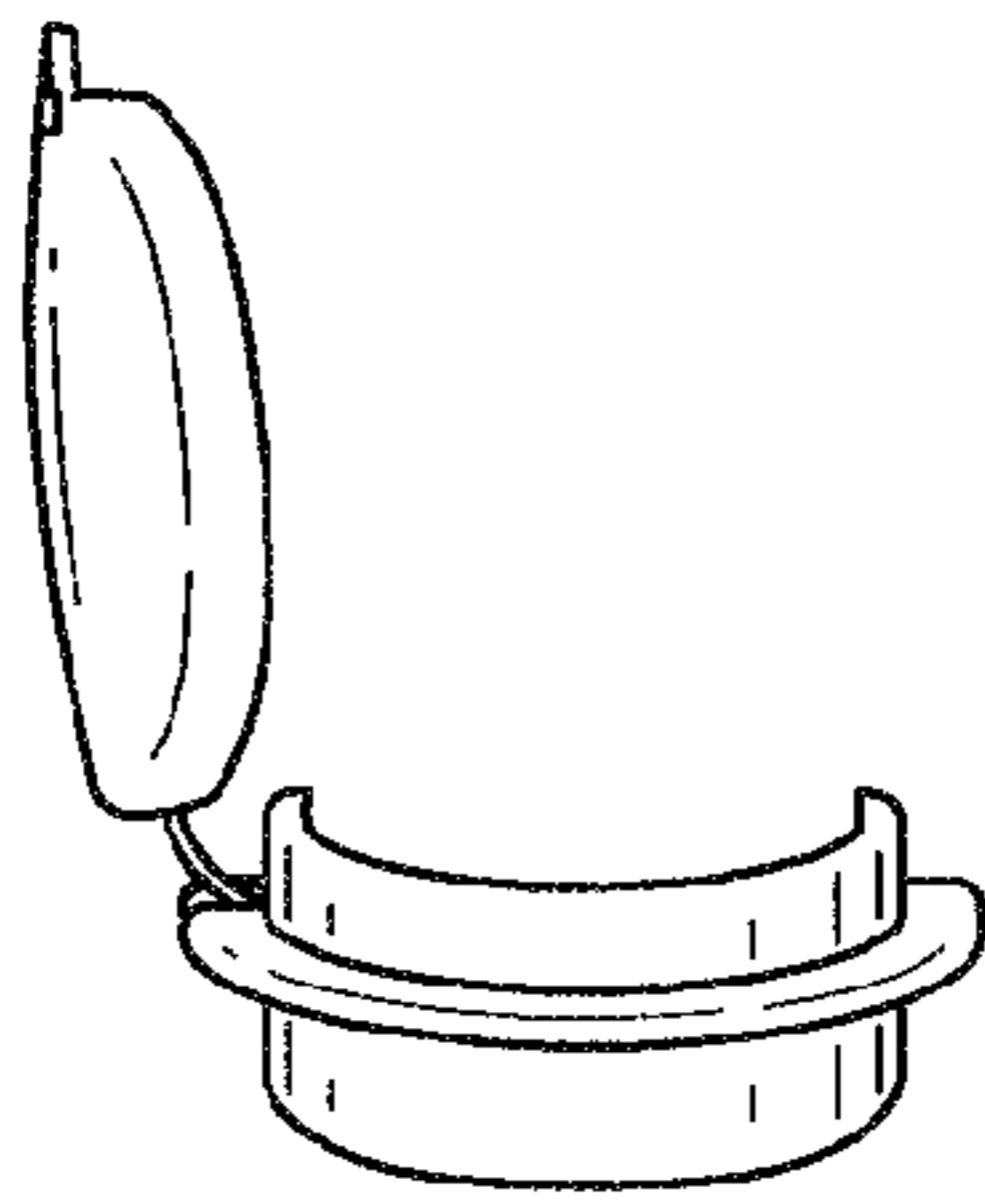

FIG. 32

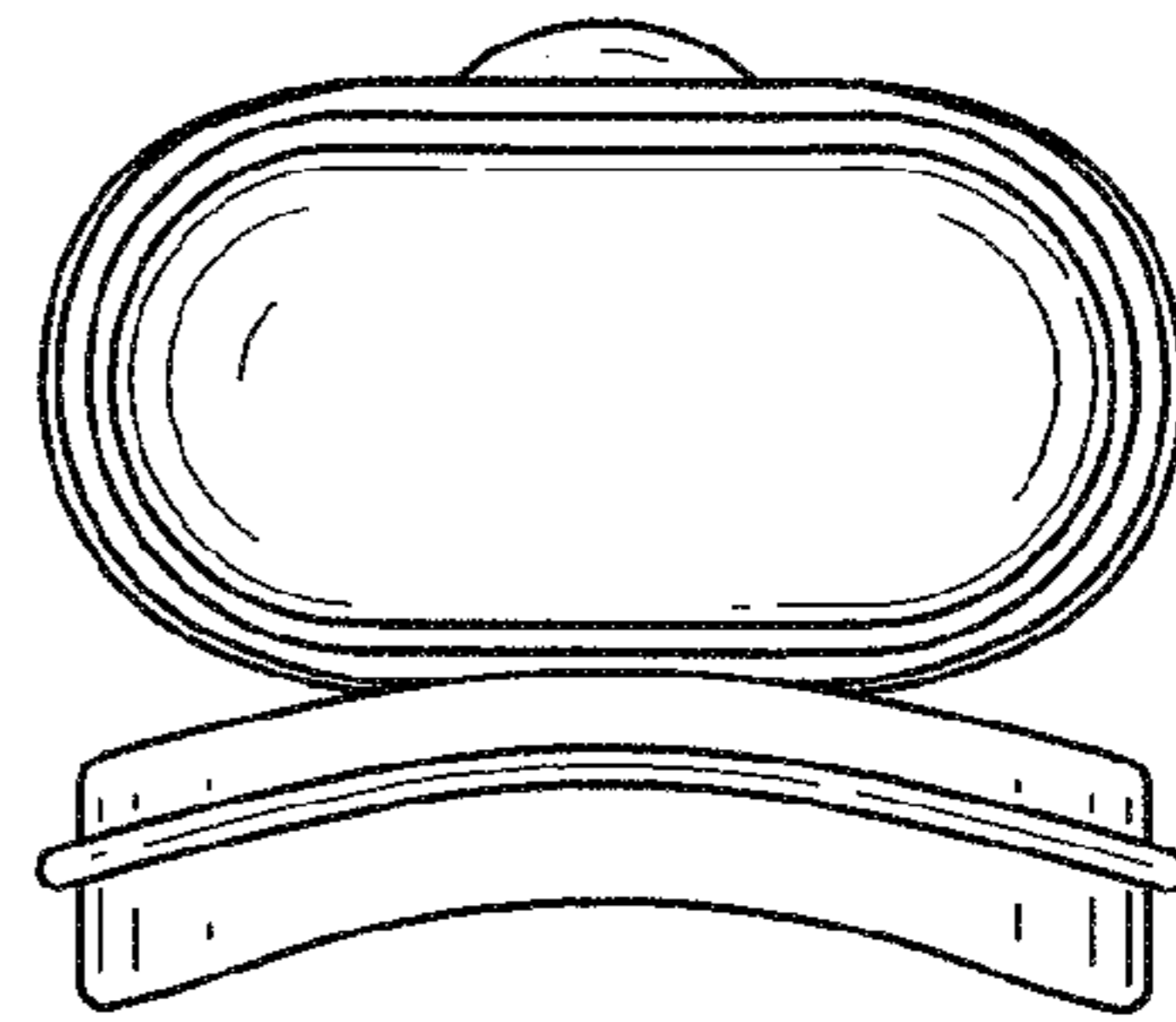

FIG. 33

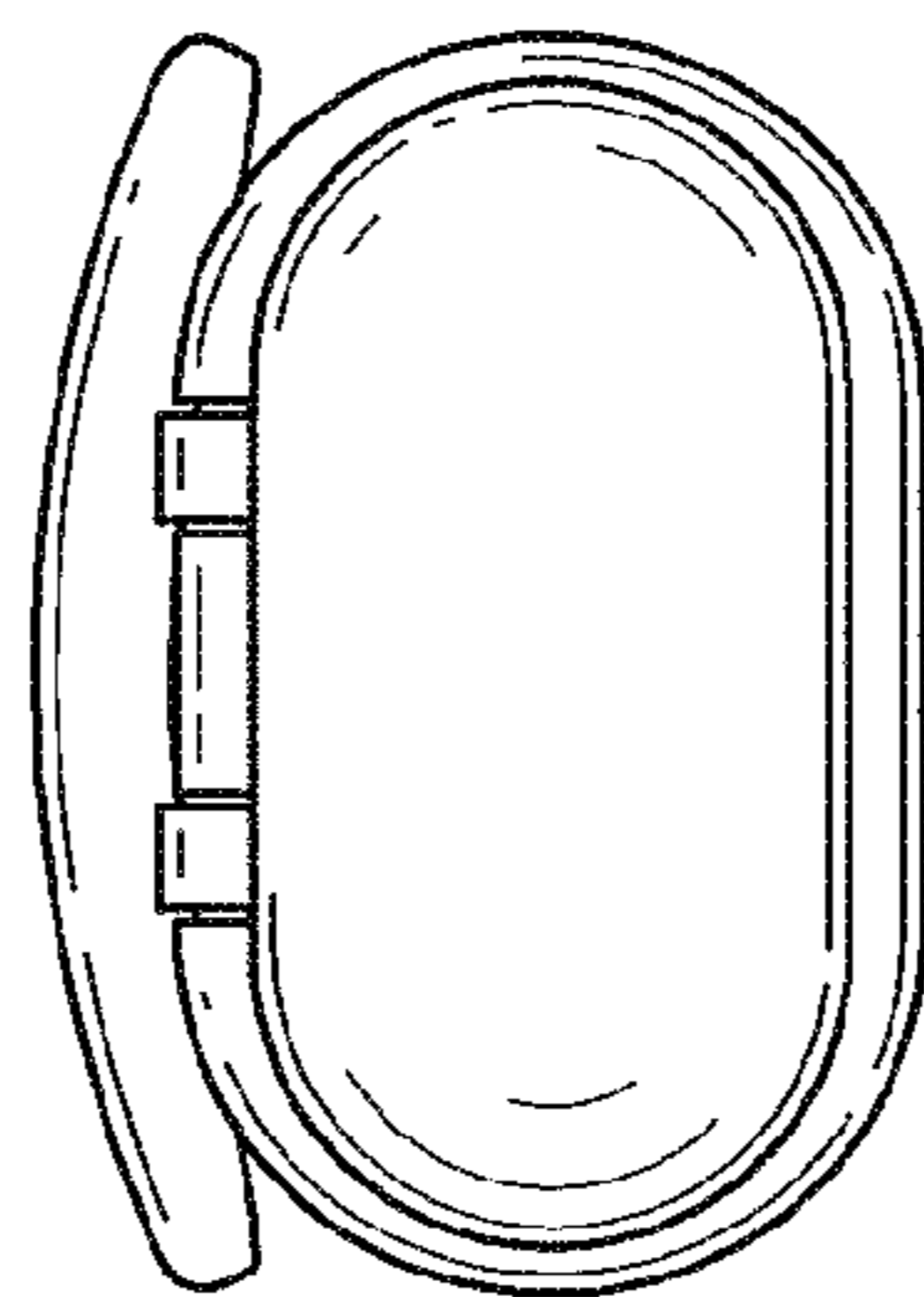

FIG. 34

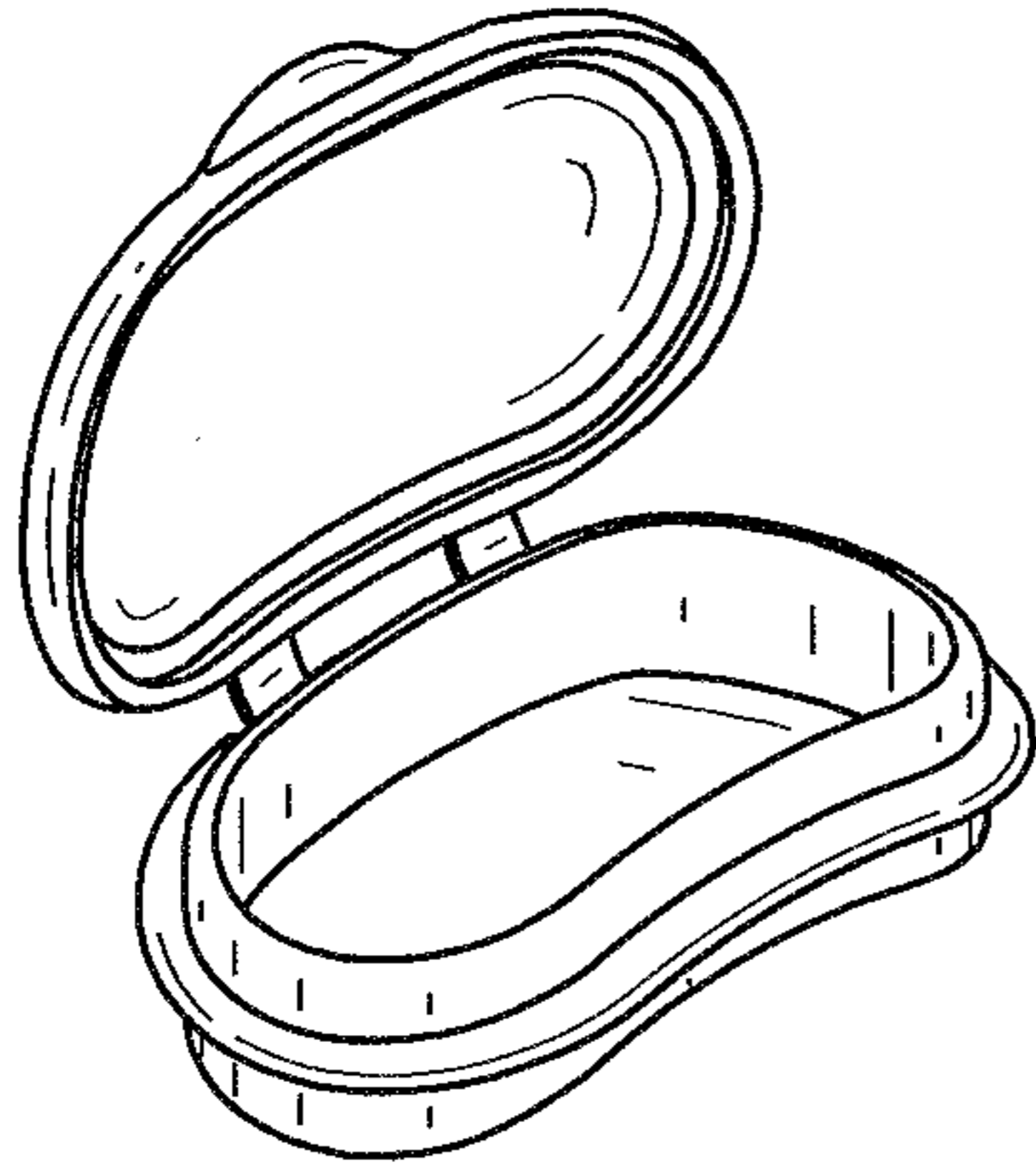

FIG. 35

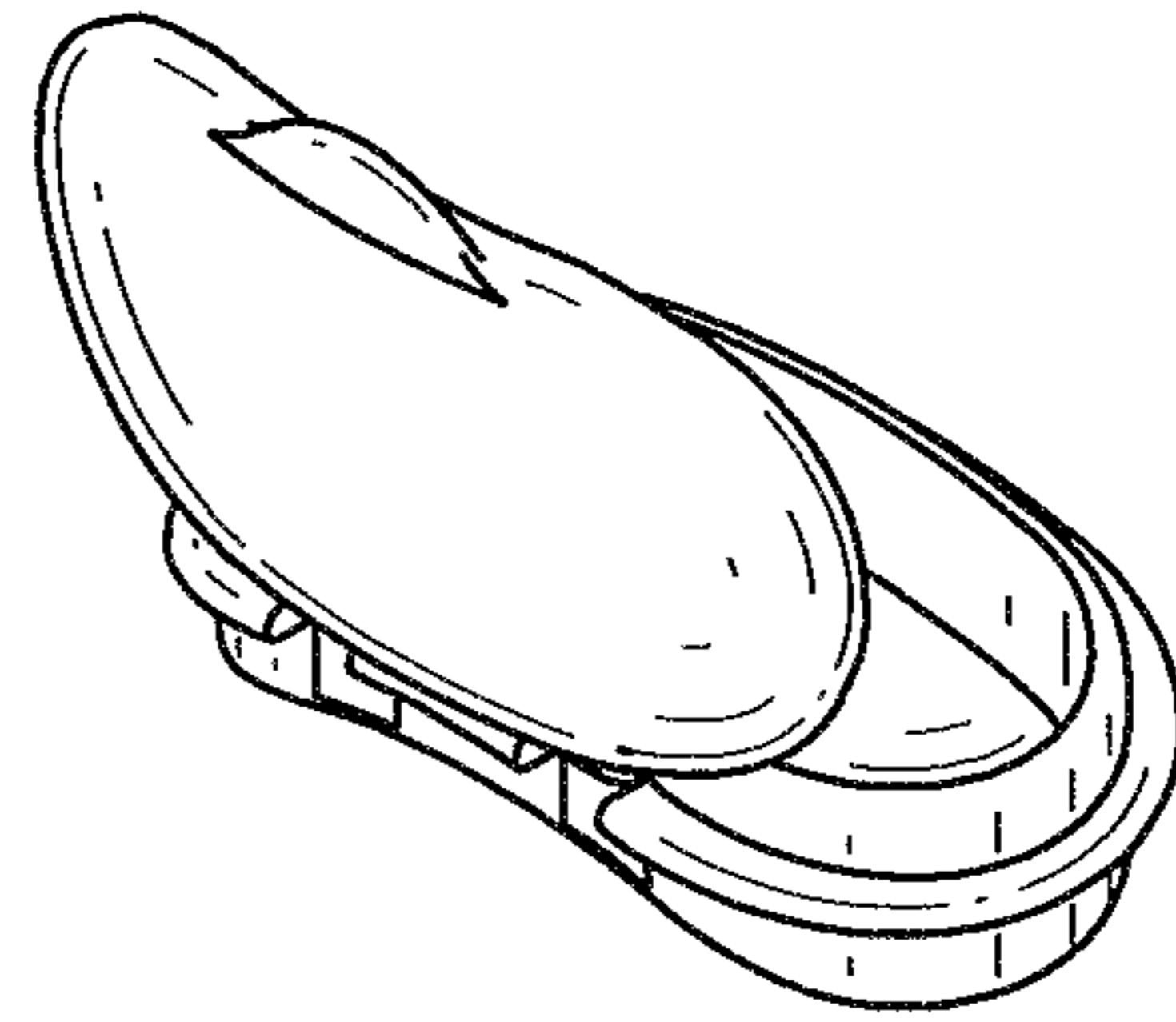

FIG. 36

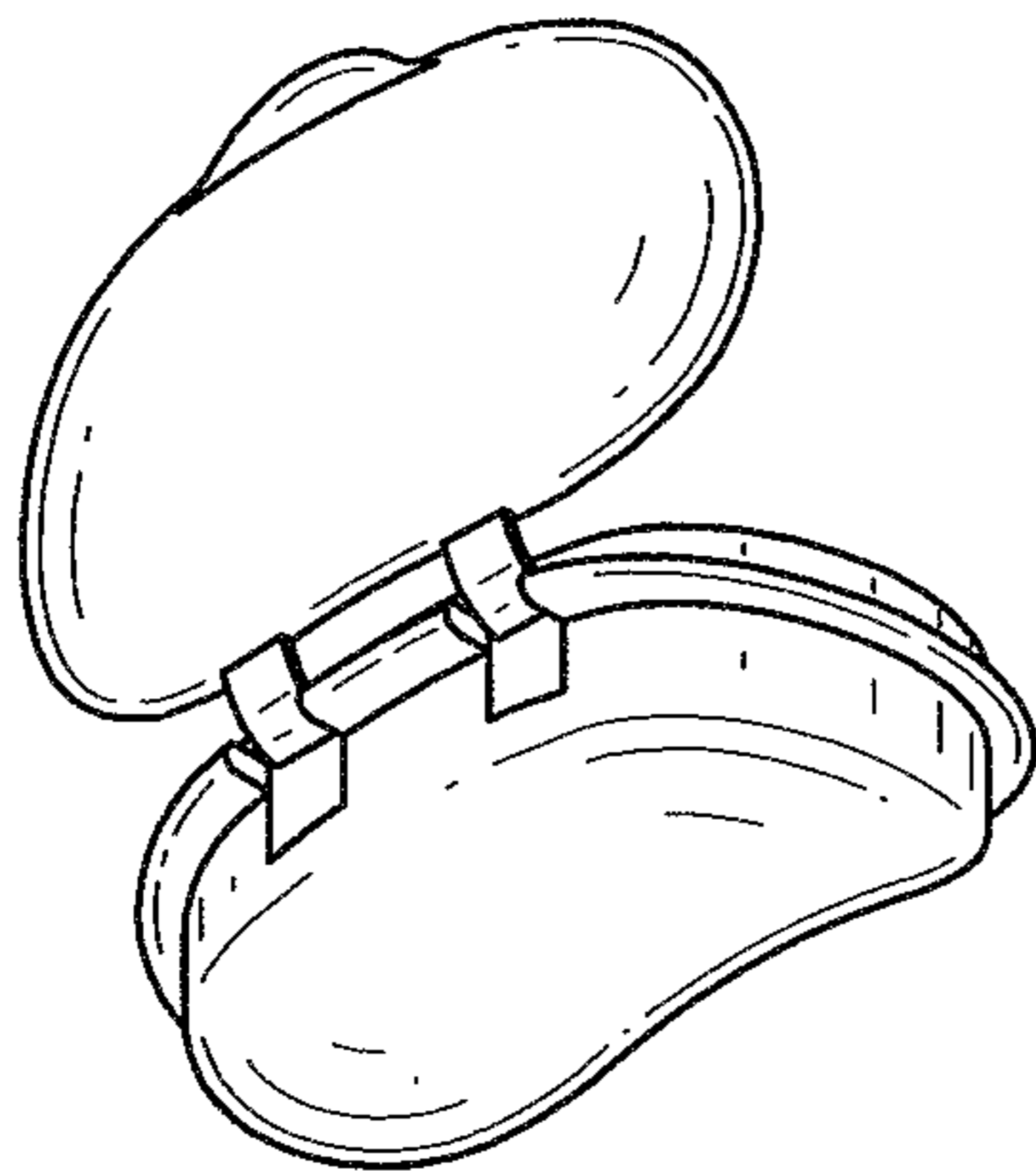

FIG. 37

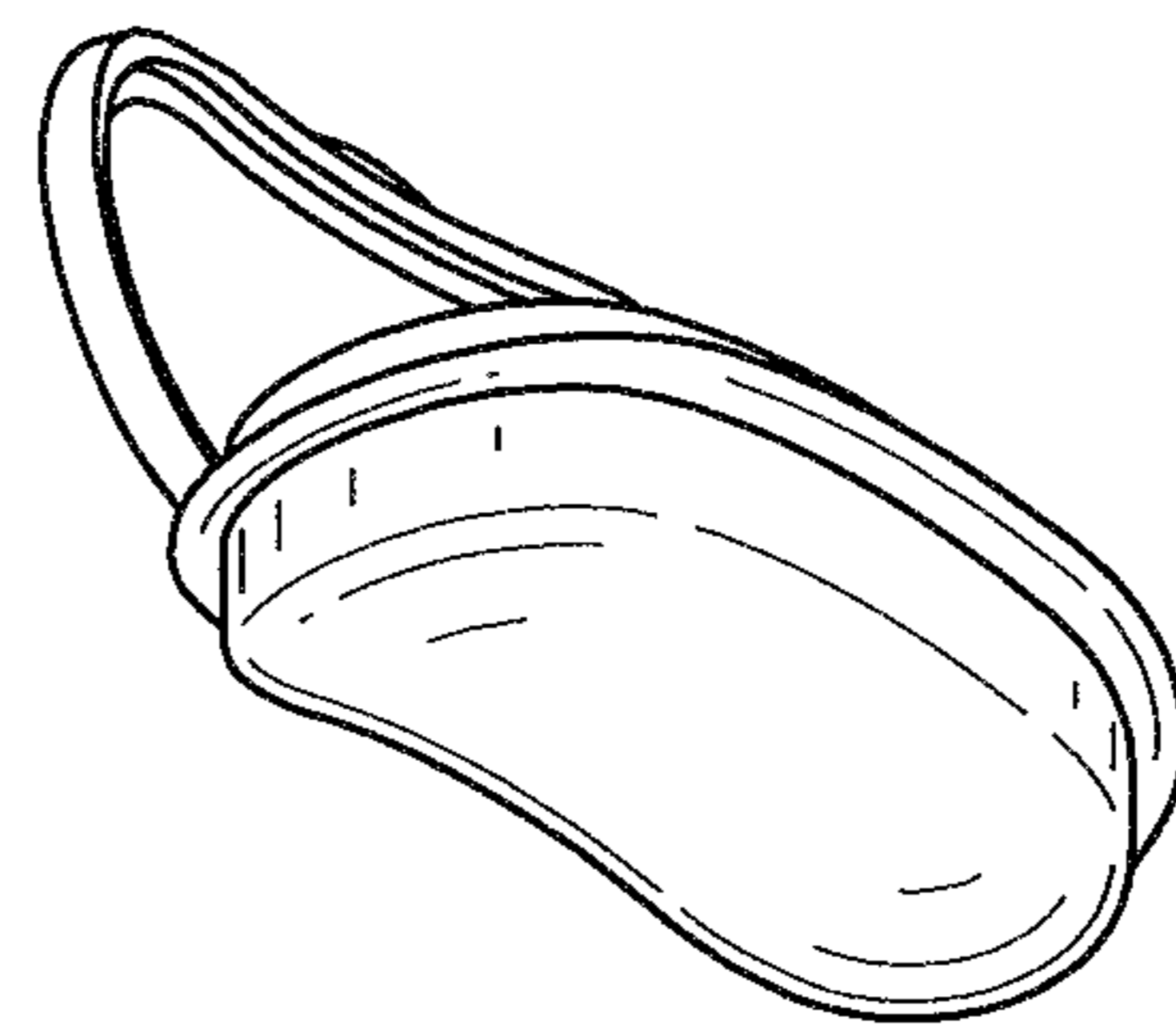

FIG. 38

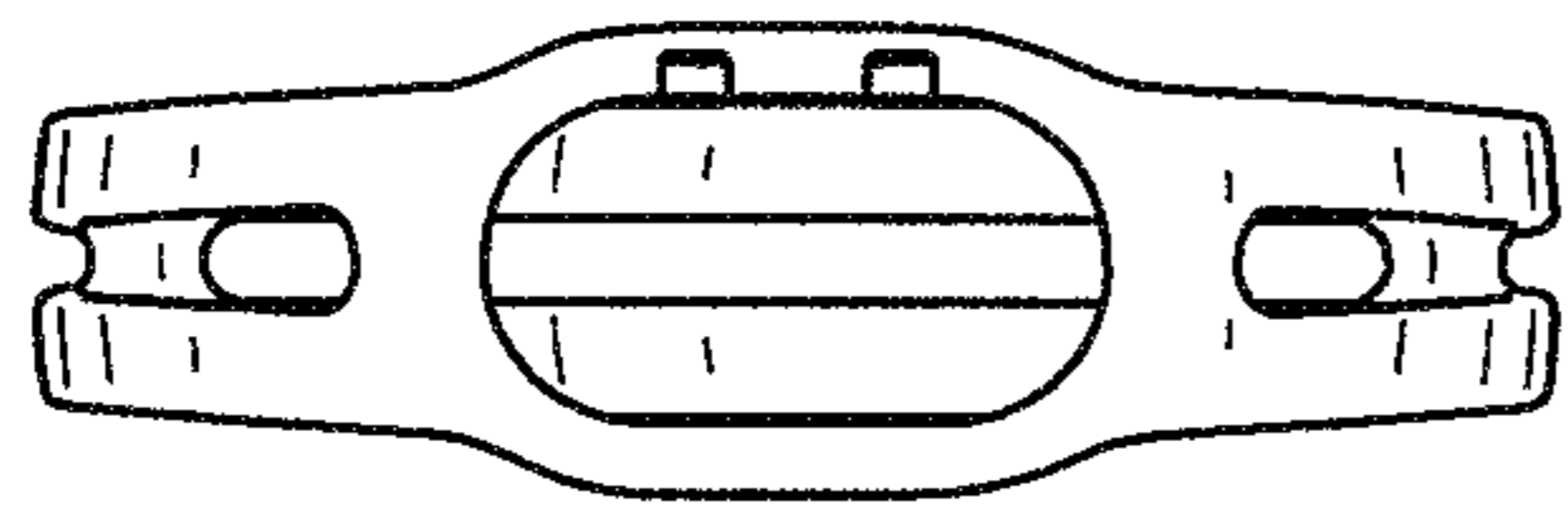

FIG.39

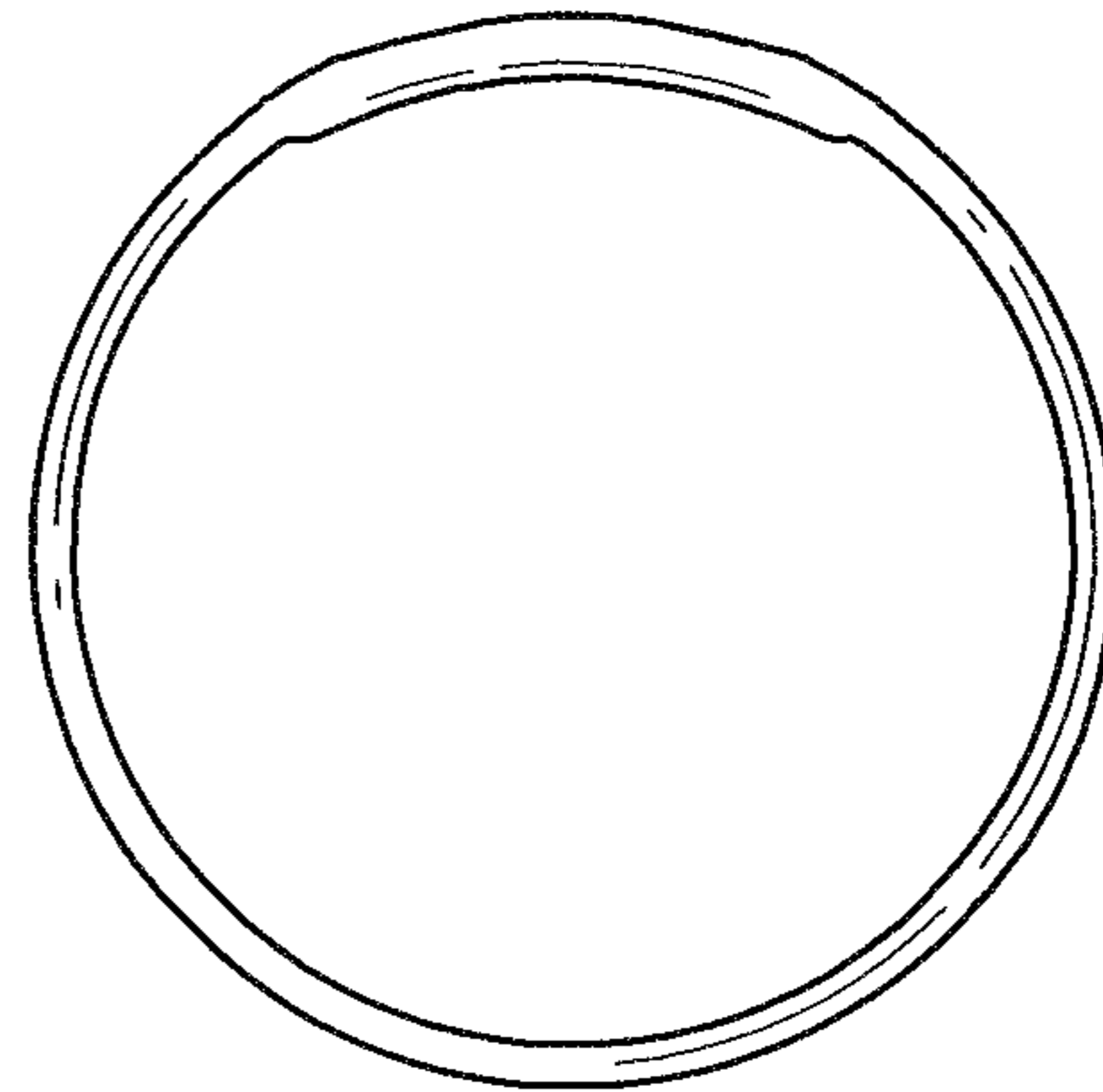

FIG.40

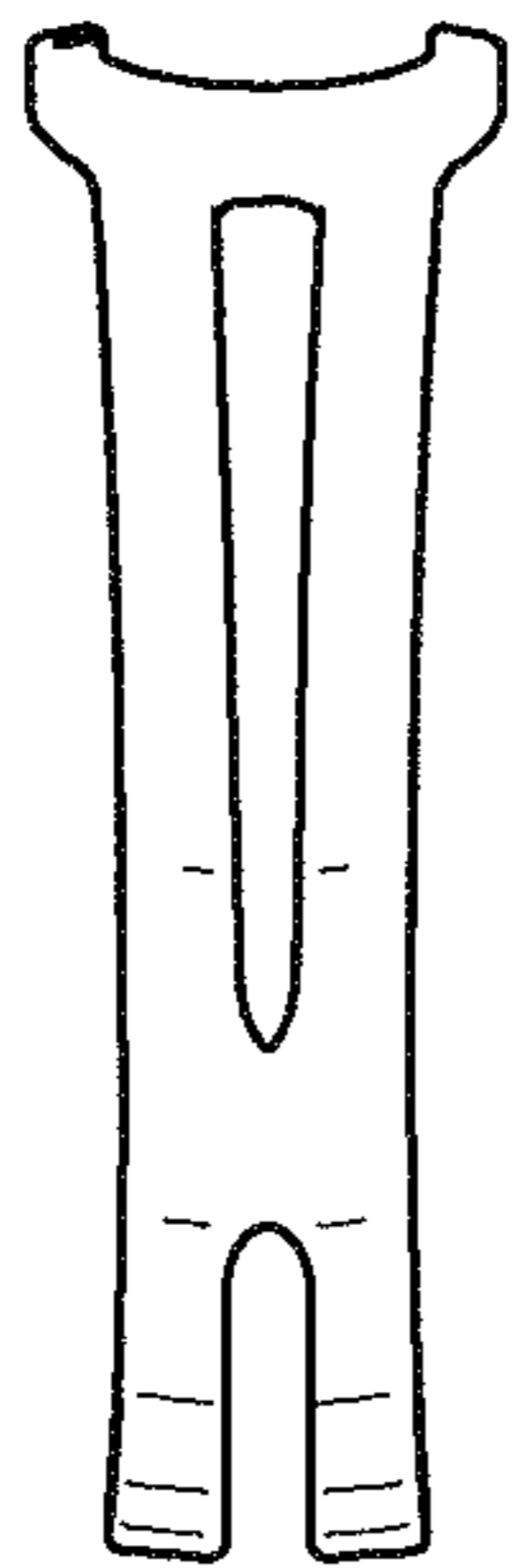

FIG.41

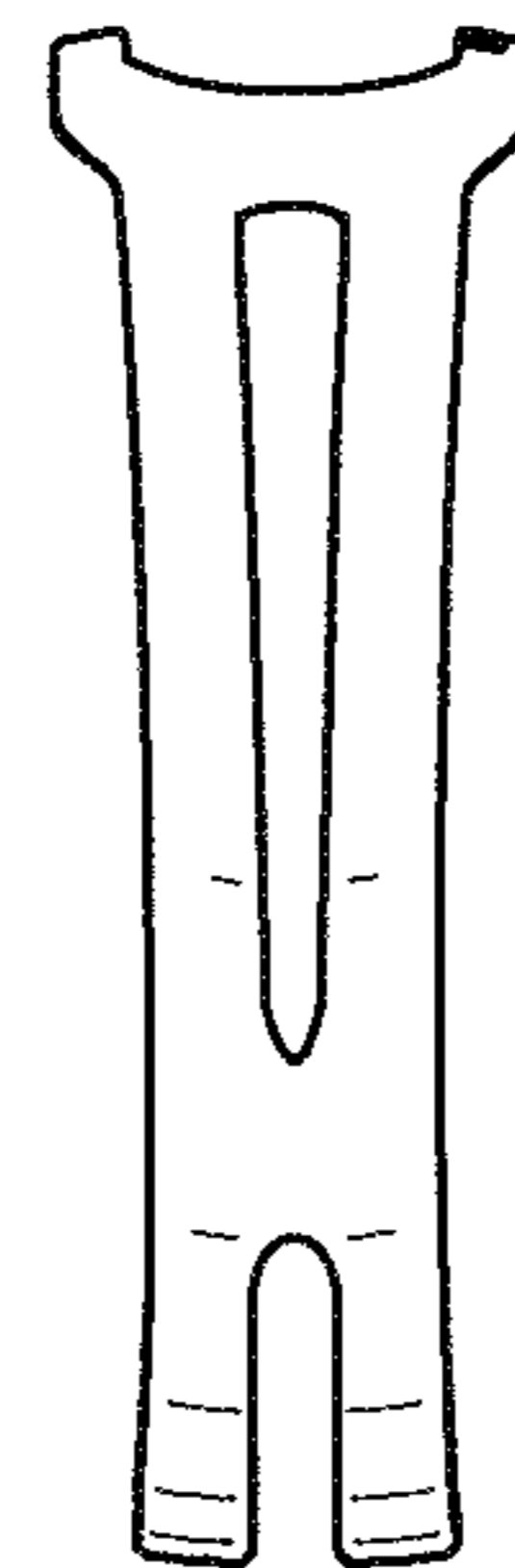

FIG.42

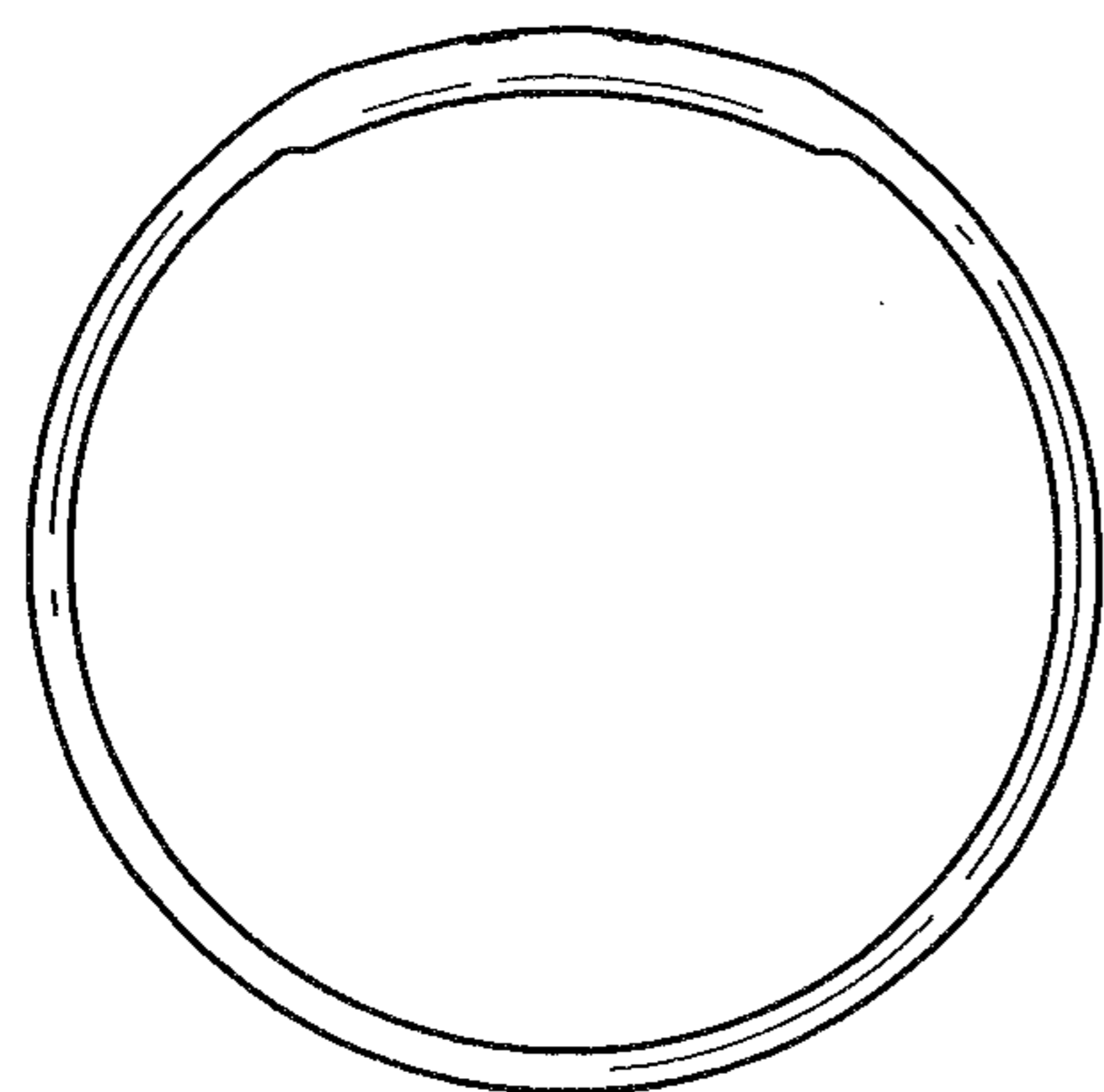

FIG.43

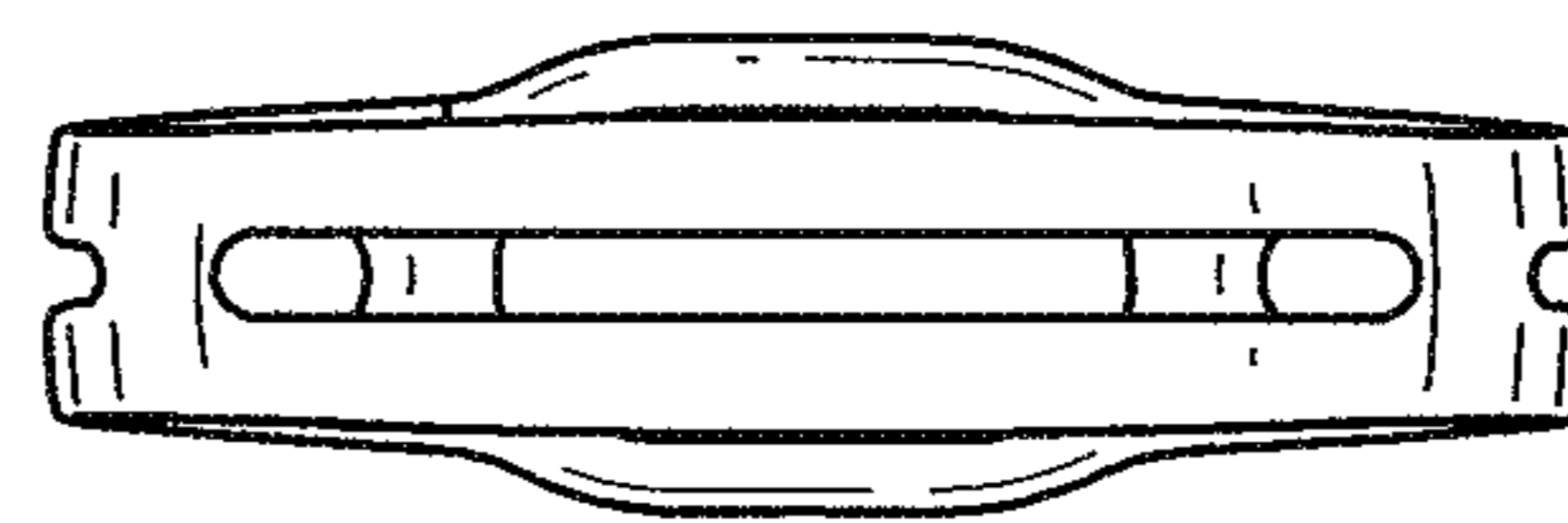

FIG.44

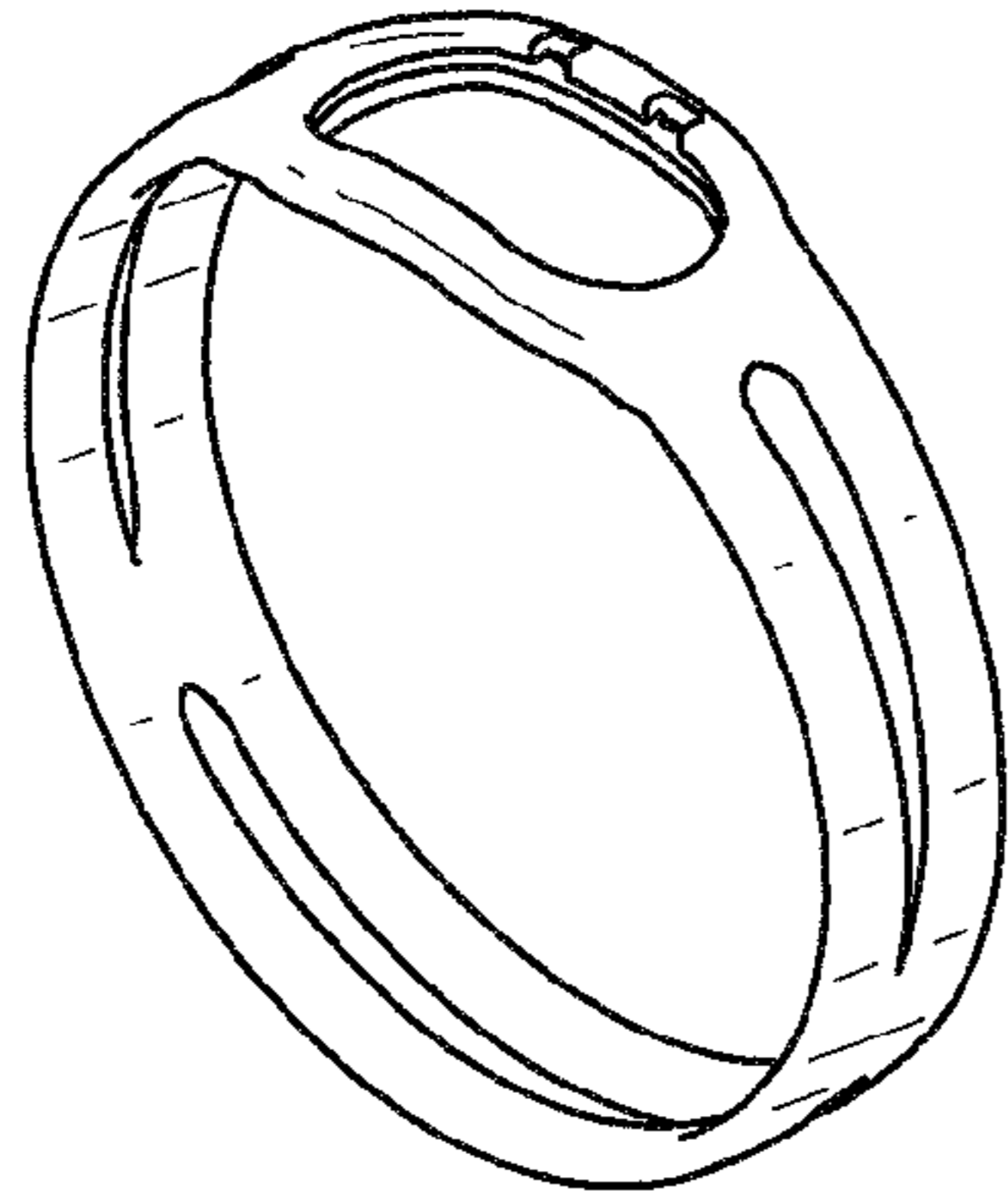

FIG.45

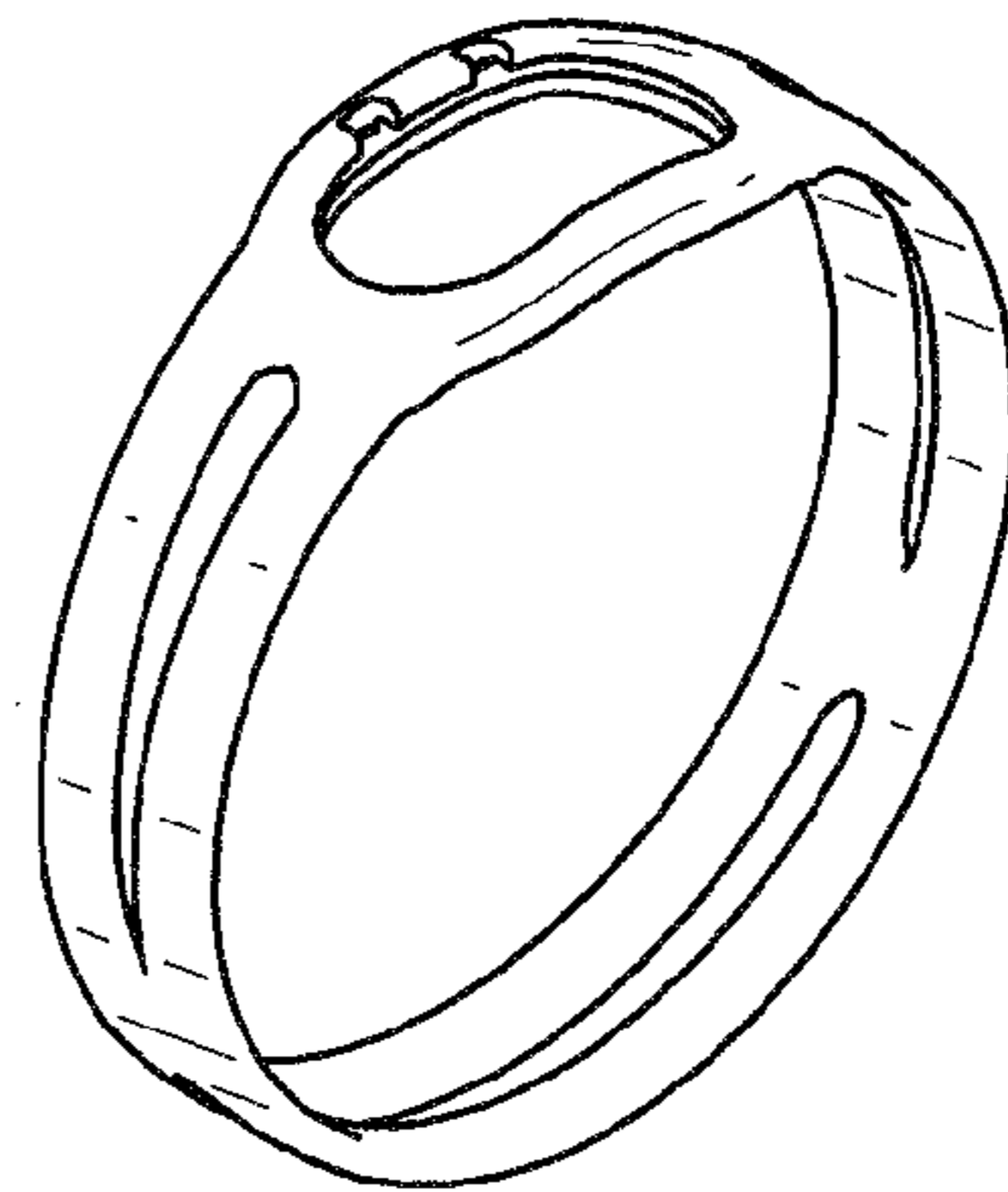

FIG.46

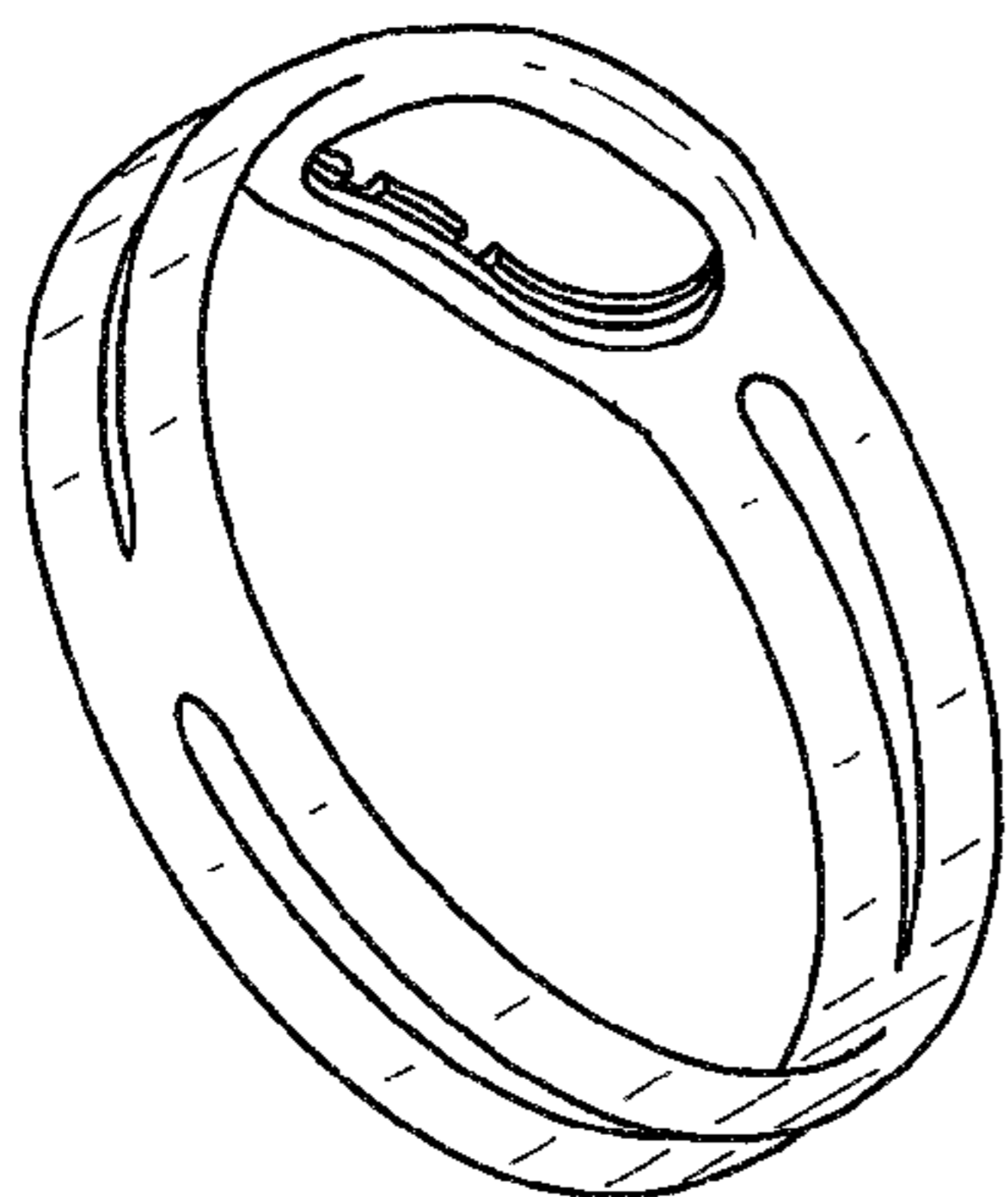

FIG.47

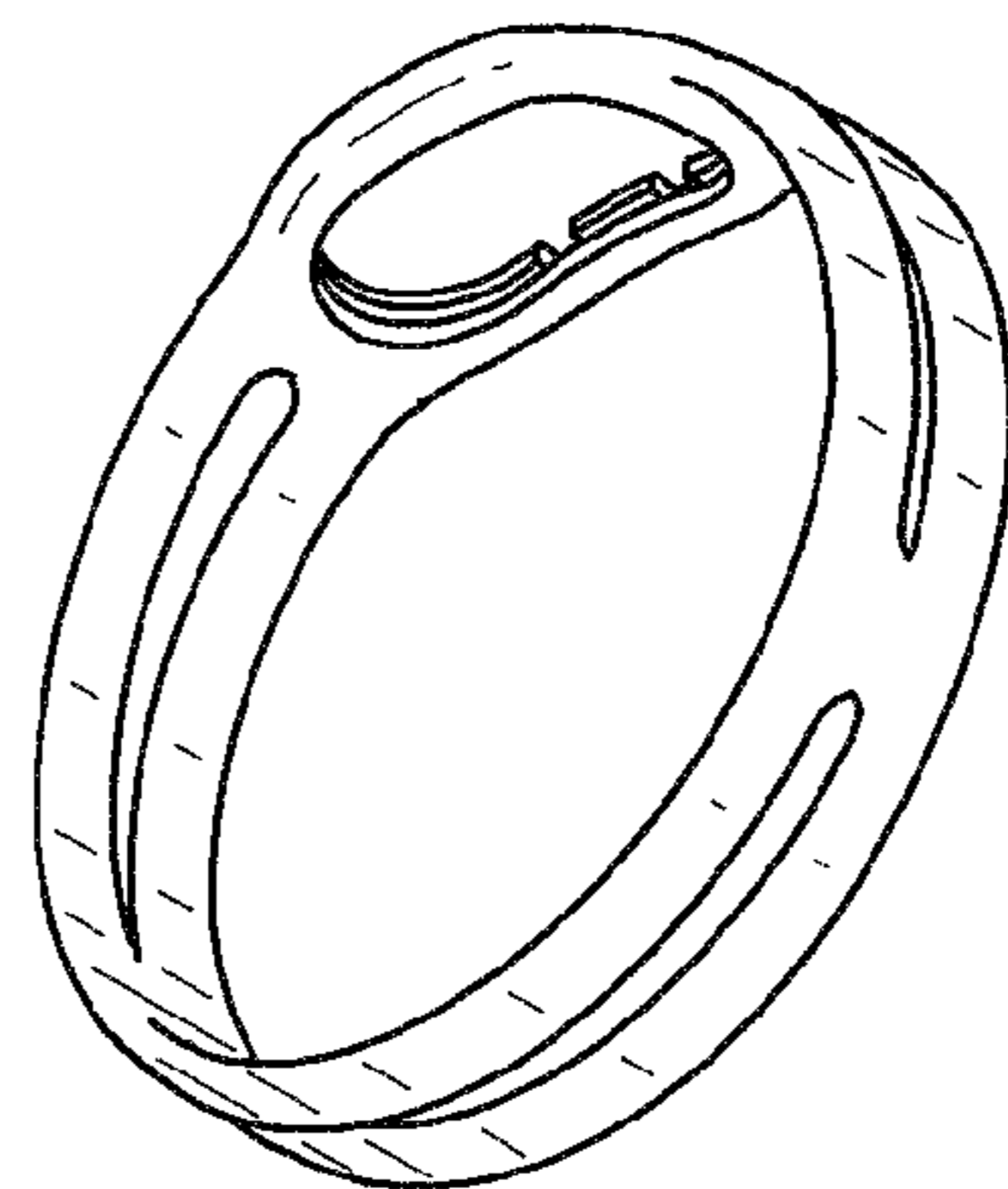

FIG.48