



US00D752433S

(12) **United States Design Patent**
Wiggins

(10) **Patent No.:** **US D752,433 S**
(45) **Date of Patent:** **** Mar. 29, 2016**

(54) **DETACHABLE CONTAINER HANDLE**

(71) Applicant: **Dart Industries Inc.**, Orlando, FL (US)

(72) Inventor: **James Michael Wiggins**, Orlando, FL (US)

(73) Assignee: **Dart Industries Inc.**, Orlando, FL (US)

(**) Term: **14 Years**

(21) Appl. No.: **29/520,704**

(22) Filed: **Mar. 17, 2015**

(51) **LOC (10) Cl.** **09-07**

(52) **U.S. Cl.**
USPC **D9/443**

(58) **Field of Classification Search**
USPC D7/387, 391-393, 392.1, 397, 404,
D7/602; D9/434-436, 440, 443-445, 447,
D9/449, 450, 453-455, 499; 16/444;
294/158, 170 X
CPC Y10T 16/44; Y10T 16/455
See application file for complete search history.

(56) **References Cited**

U.S. PATENT DOCUMENTS

- 479,588 A * 7/1892 Flanagan E05B 1/0015
16/444
- D188,553 S 8/1960 Tupper
- D206,079 S 10/1966 Swett
- 4,782,556 A * 11/1988 Kim A45C 13/26
150/110
- D301,089 S * 5/1989 Kim D8/306
- 5,116,240 A 5/1992 Wischhusen et al.
- 5,547,098 A 8/1996 Jordan
- 5,652,999 A * 8/1997 Jarvis B25G 1/10
16/110.1
- D421,386 S * 3/2000 Ota D9/434
- D423,349 S * 4/2000 Lyons D9/434
- 6,209,725 B1 4/2001 Chen
- D442,823 S * 5/2001 Wright D7/393
- D451,340 S * 12/2001 Ide D7/393
- D462,877 S 9/2002 Lillelund et al.

- D472,774 S 4/2003 Pelstring et al.
- D510,522 S * 10/2005 Laveault D9/434
- D511,632 S 11/2005 Lown
- D528,301 S * 9/2006 Proot D3/318
- D583,664 S * 12/2008 Franzone, Jr. D9/434
- 7,510,096 B2 3/2009 Wang

(Continued)

FOREIGN PATENT DOCUMENTS

- DE 102007032382 A1 1/2008
- EP 1 026 090 A1 9/2000

OTHER PUBLICATIONS

Snapware Everyday Egg-Tainer; Oct. 21, 2010.

(Continued)

Primary Examiner — Robert M Spear

Assistant Examiner — Darcey E Heflin

(74) *Attorney, Agent, or Firm* — Taylor J. Ross

(57) **CLAIM**

The ornamental design for a detachable container handle, as shown and described.

DESCRIPTION

This application is related to co-pending application Ser. Nos. 29/520,688, 29/520,691 and 29/520,706, which are incorporated by reference herein.

FIG. 1 is a top, front and right side perspective view of a detachable container handle showing my new design;

FIG. 2 is a bottom, rear and left side perspective view thereof;

FIG. 3 is a top plan view thereof;

FIG. 4 is a bottom plan view thereof;

FIG. 5 is a front elevation view, the rear elevation being identical thereto;

FIG. 6 is a right side elevation view, the left side being identical thereto; and,

FIG. 7 is a cross-sectional view taken in the direction of line 7-7 of FIG. 3.

1 Claim, 3 Drawing Sheets

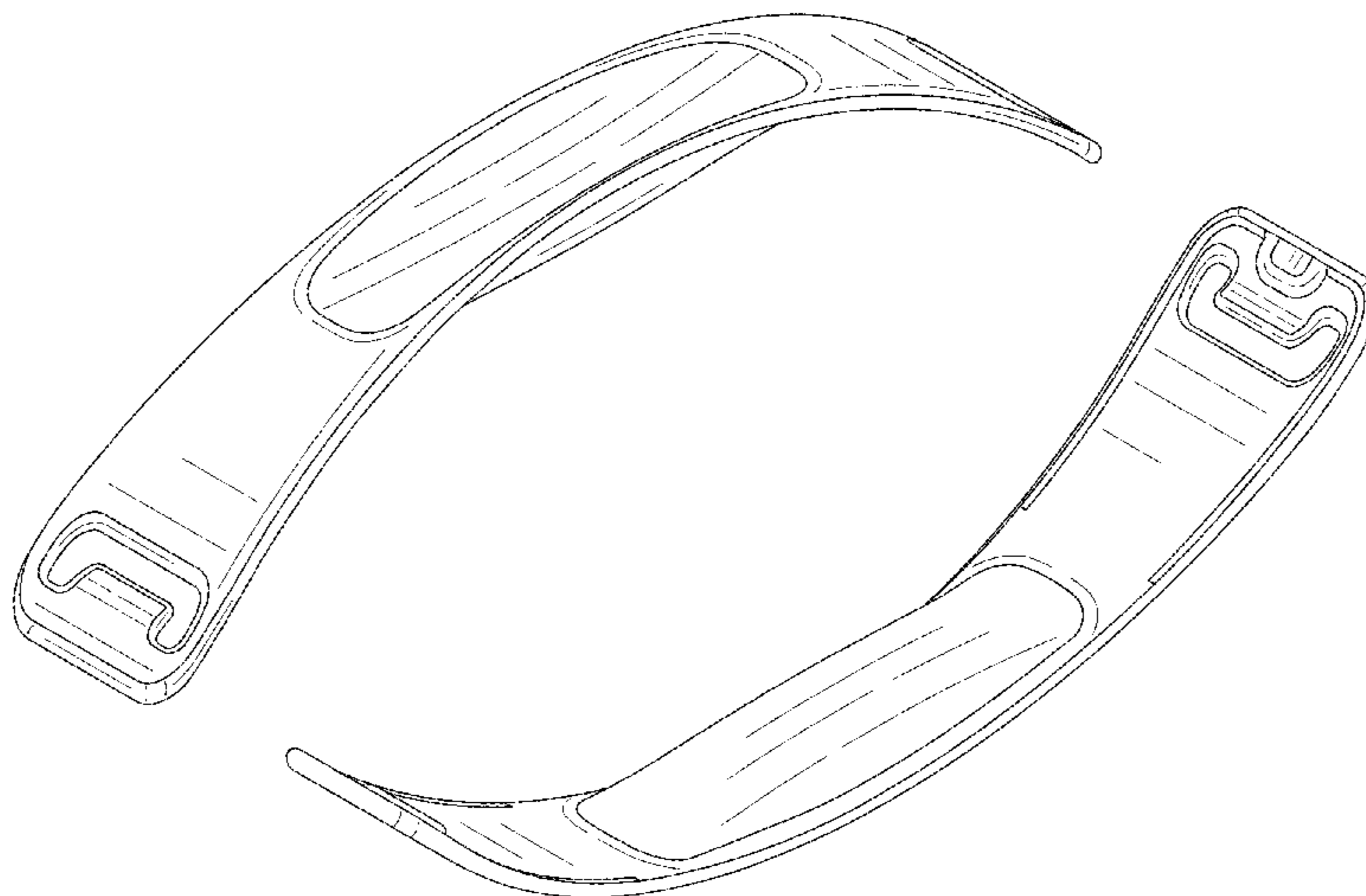

(56)

References Cited

U.S. PATENT DOCUMENTS

D598,746 S * 8/2009 Caldwell D9/435
D605,937 S * 12/2009 Lovelace, Jr. D9/434
D612,721 S * 3/2010 Clamagirand B60S 1/3848
D9/415
D630,887 S 1/2011 Olivari
8,621,720 B2 * 1/2014 Kao B29C 45/14065

D746,101 S * 12/2015 Manley D7/387
2009/0236255 A1 9/2009 Piacenza et al. 16/114.1

OTHER PUBLICATIONS

Monbento Original Bento Box; MonbentoTM; Jun. 20, 2012.
Snapware Snap N Stack Storage Container; Snapware; Jun. 9, 2011.

* cited by examiner

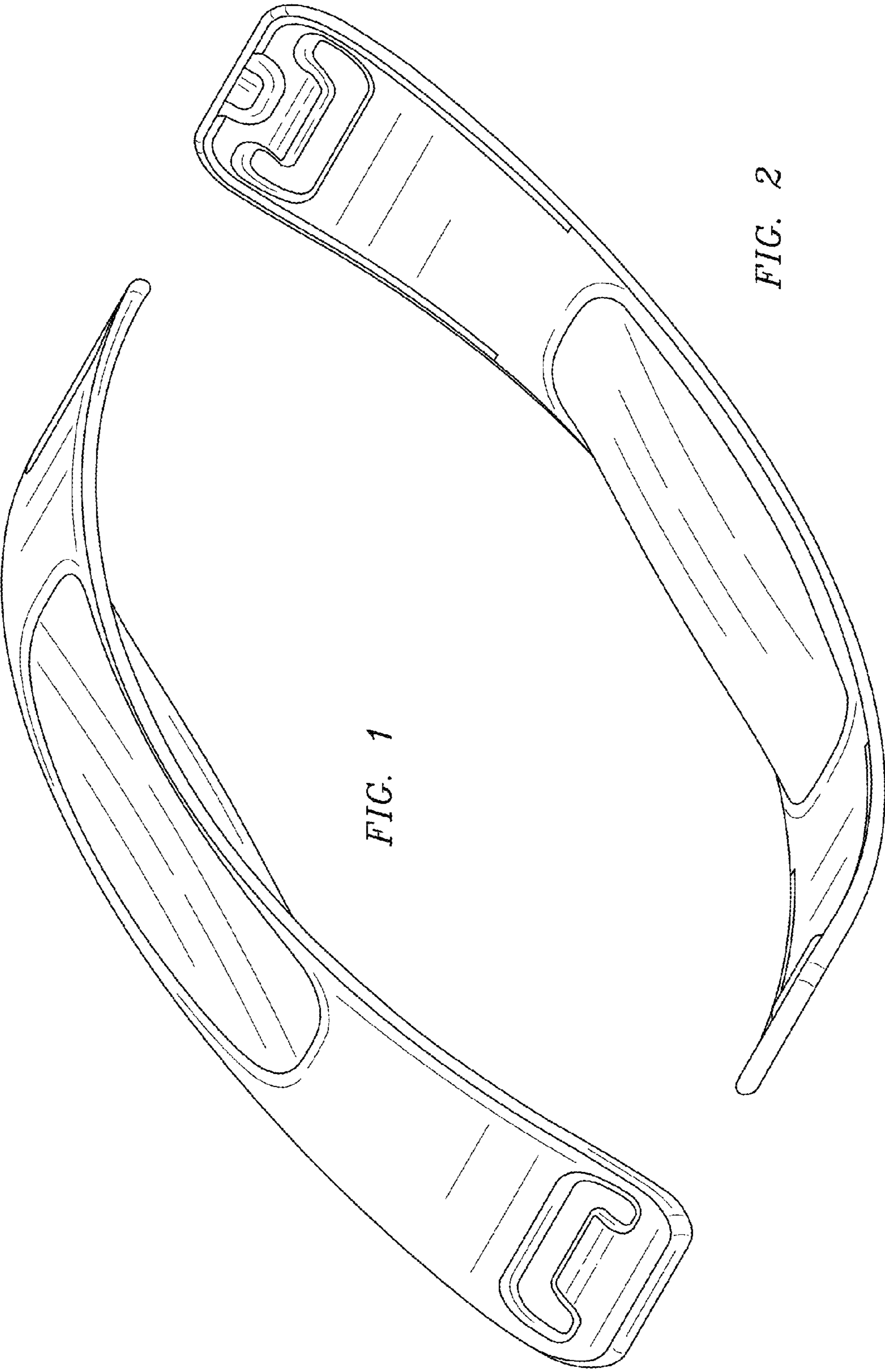

FIG. 1

FIG. 2

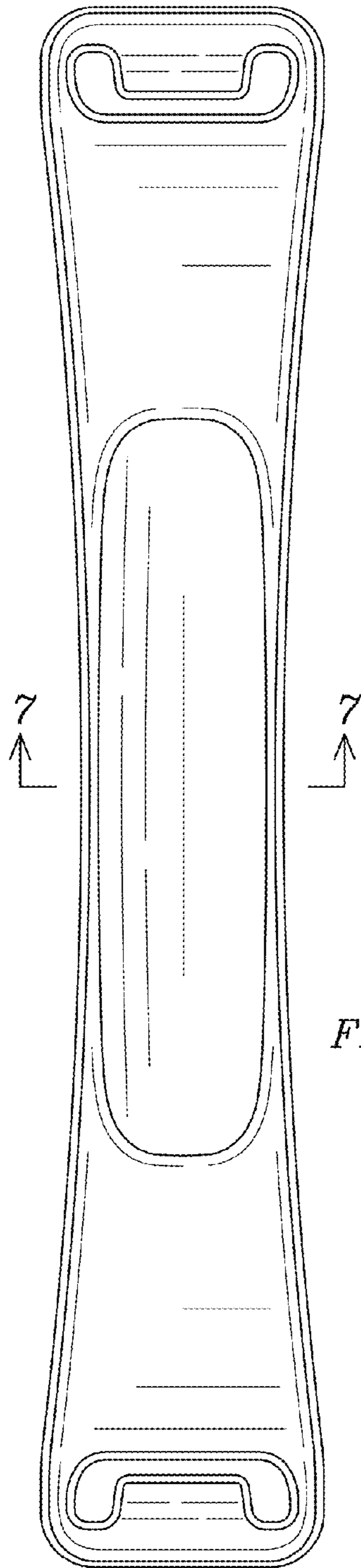

FIG. 3

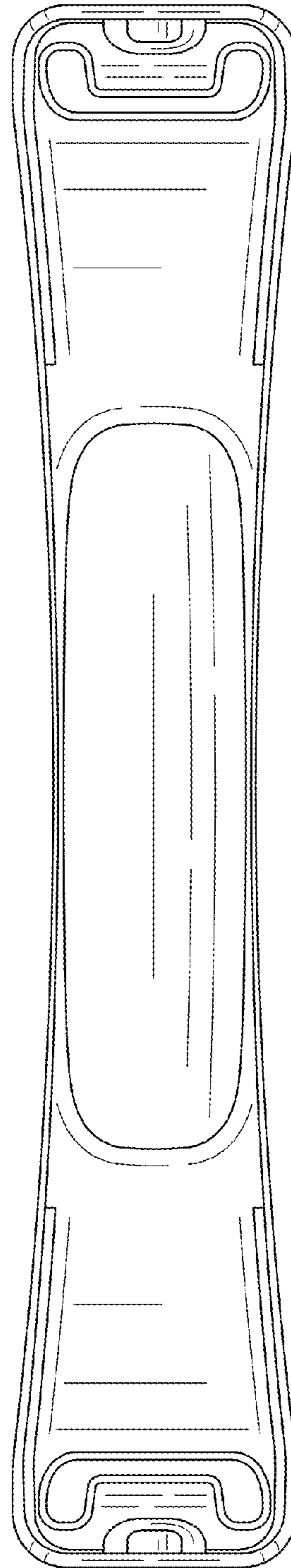

FIG. 4

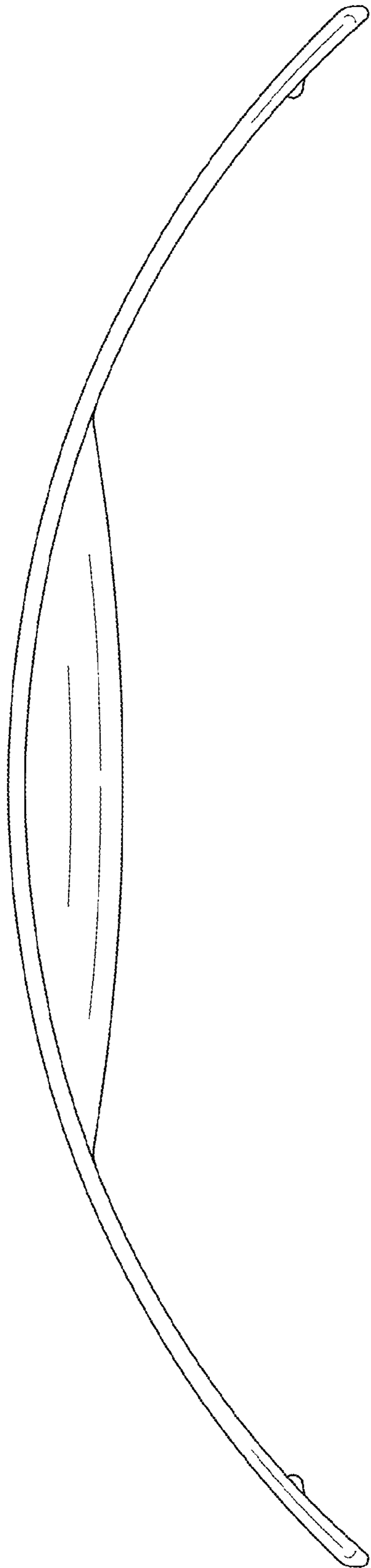

FIG. 5

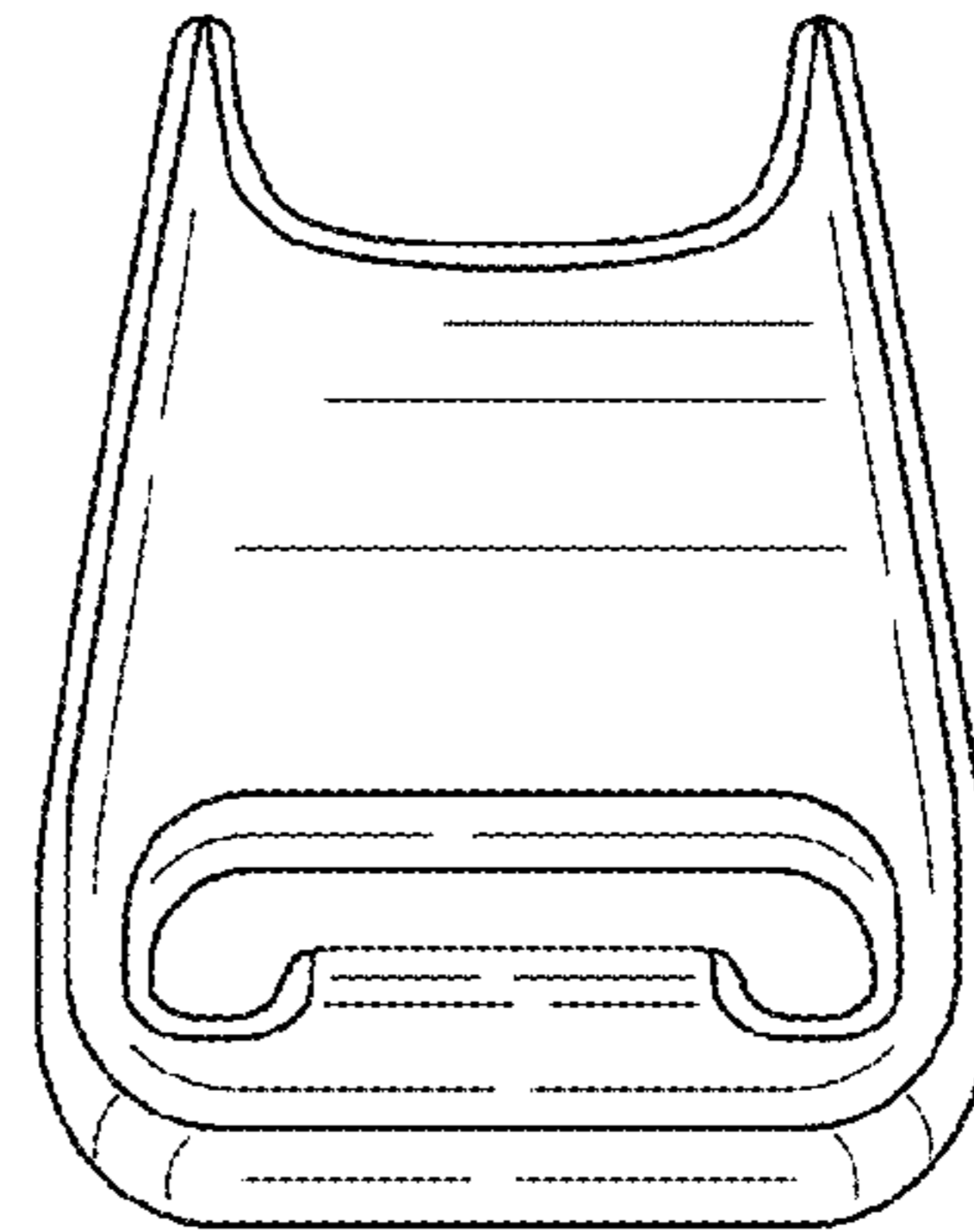

FIG. 6

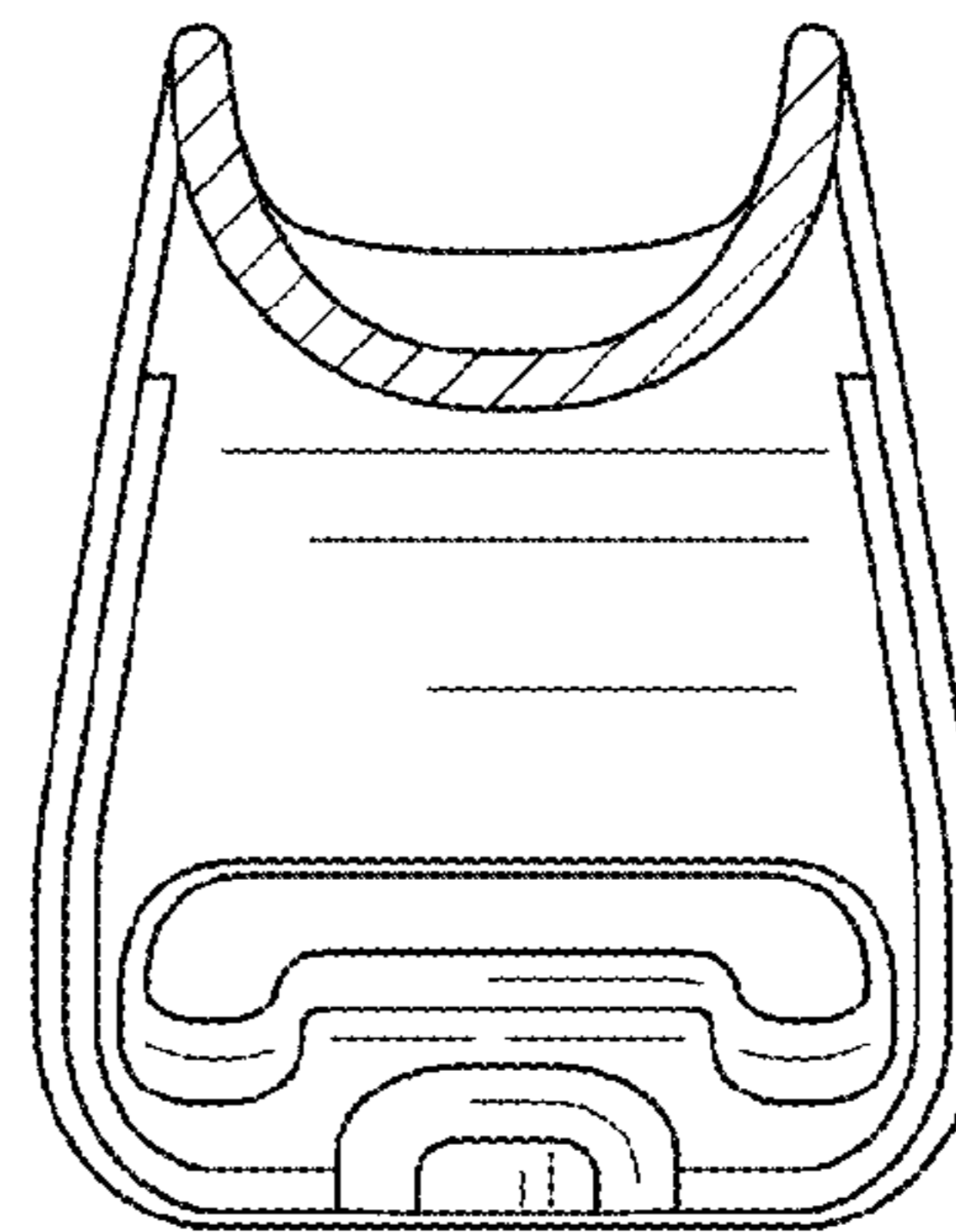

FIG. 7