



US00D752394S

(12) **United States Design Patent**
Boyden

(10) **Patent No.:** **US D752,394 S**
(45) **Date of Patent:** **** Mar. 29, 2016**

- (54) **BOWL**
- (71) Applicant: **Andrew Boyden**, Fort Wayne, IN (US)
- (72) Inventor: **Andrew Boyden**, Fort Wayne, IN (US)
- (**) Term: **14 Years**
- (21) Appl. No.: **29/519,619**
- (22) Filed: **Mar. 6, 2015**

Related U.S. Application Data

- (63) Continuation-in-part of application No. 29/506,952, filed on Oct. 22, 2014.
- (51) **LOC (10) Cl.** **07-01**
- (52) **U.S. Cl.**
USPC **D7/559**; D7/567; D7/571; D7/515
- (58) **Field of Classification Search**
USPC D7/523, 532, 507, 509, 514, 515, 524, D7/564, 559, 551.1, 544, 567, 571, 536, D7/533, 625, 619.2, 689, 651; 220/713, 220/703, 592.16; D2/918, 930, 925, 931, D2/950; D19/91; D30/129, 102; D28/73, D28/61, 67
CPC . A47G 19/2205; A47G 19/02; B67D 1/0418; A24F 3/00
See application file for complete search history.

(56) **References Cited**

U.S. PATENT DOCUMENTS

- D103,180 S * 2/1937 McCain D2/930
- D131,570 S * 3/1942 Vivier D2/930
- D232,209 S 7/1974 Edwards
- D255,843 S * 7/1980 Goldman D2/950
- D264,417 S 5/1982 Urda et al.
- D349,217 S 8/1994 Spencer
- D387,192 S * 12/1997 Srourian D2/947
- D512,879 S * 12/2005 Haakenson D7/619.2
- 7,040,678 B1 5/2006 Haakenson
- D523,086 S * 6/2006 Jones D19/91
- D523,480 S * 6/2006 Jones D19/91
- D523,481 S * 6/2006 Jones D19/91
- D529,264 S * 10/2006 Choi D2/930

- D535,155 S * 1/2007 Leahy D7/619.2
- D558,437 S * 1/2008 Wilkinson D2/971
- D562,540 S * 2/2008 Guers-Neyrud D2/971
- D567,024 S 4/2008 Yeh
- D567,599 S * 4/2008 Kushner D7/651
- D582,637 S * 12/2008 Guers-Neyraud D2/925
- D595,543 S * 7/2009 Mandel D2/910
- D626,793 S * 11/2010 Horwitz D7/642

(Continued)

FOREIGN PATENT DOCUMENTS

EP 1763992 A1 3/2007

OTHER PUBLICATIONS

- <http://www.rousseau.co.uk/high-heel-nibbles-holder/>, reviewed Sep. 25, 2014.
- <https://www.etsy.com/listing/37326199/high-heel-party-serve-ware-candy-dish>, SoleSensations, reviewed Sep. 25, 2014.
- <https://www.creative-hobbies.com/4208-high-heel-cell-phone-holder-4-high-x-5-3-4-long.html>, p. 1, Creative Hobbies, Inc., reviewed Sep. 25, 2014.

(Continued)

Primary Examiner — Marianne Pandozzi

(57) **CLAIM**

The ornamental design for an ornamental bowl, as shown and described.

DESCRIPTION

FIG. 1 is a perspective view of an ornamental bowl showing my new design;
 FIG. 2 is a left side view thereof;
 FIG. 3 is a right side view thereof;
 FIG. 4 is a front view thereof;
 FIG. 5 is a rear view thereof;
 FIG. 6 is a top plan view thereof;
 FIG. 7 is a bottom plan view; and,
 FIG. 8 is an environmental perspective view thereof.
 The broken lines depict environmental structure and form no part of the claimed design.

1 Claim, 7 Drawing Sheets

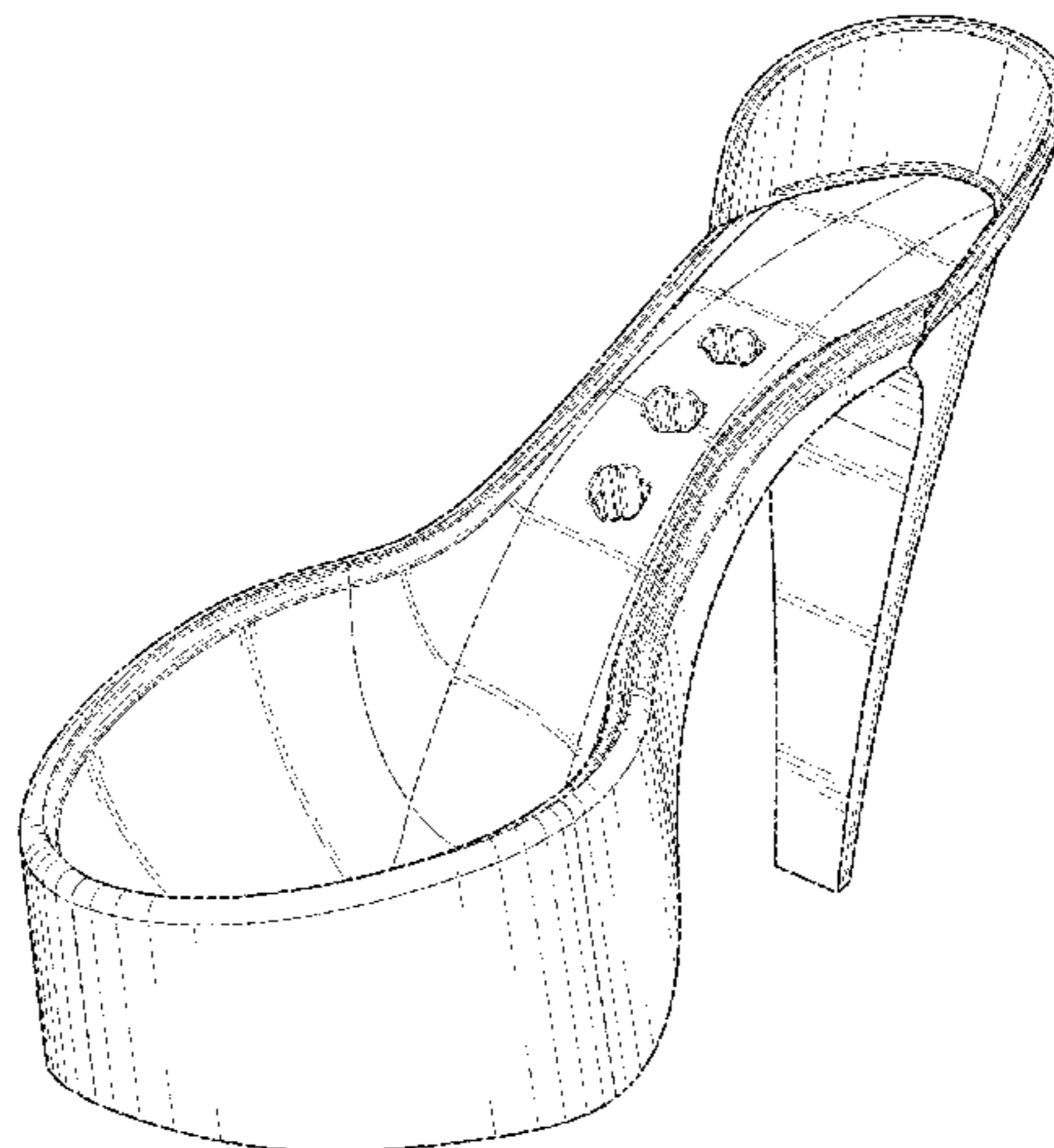

(56)

References Cited

U.S. PATENT DOCUMENTS

D647,370 S * 10/2011 van Dijk D11/150
D677,988 S * 3/2013 Eubank D2/910
D718,986 S * 12/2014 Sekse D7/651
D718,987 S * 12/2014 Sekse D7/651
D741,052 S * 10/2015 Guers-Neyraud D2/925

OTHER PUBLICATIONS

<http://www.jonathanadler.com/Shoe-Butter-Dish/>, Jonathan Adler, reviewed Sep. 25, 2014.

<http://www.woodenduckshoppe.com/shoppe/patience-brewster-high-heel-shoe-serving-plate.html>, The Wooden Duck, High Heel Shoe Serving Tray, reviewed Sep. 25, 2014.

* cited by examiner

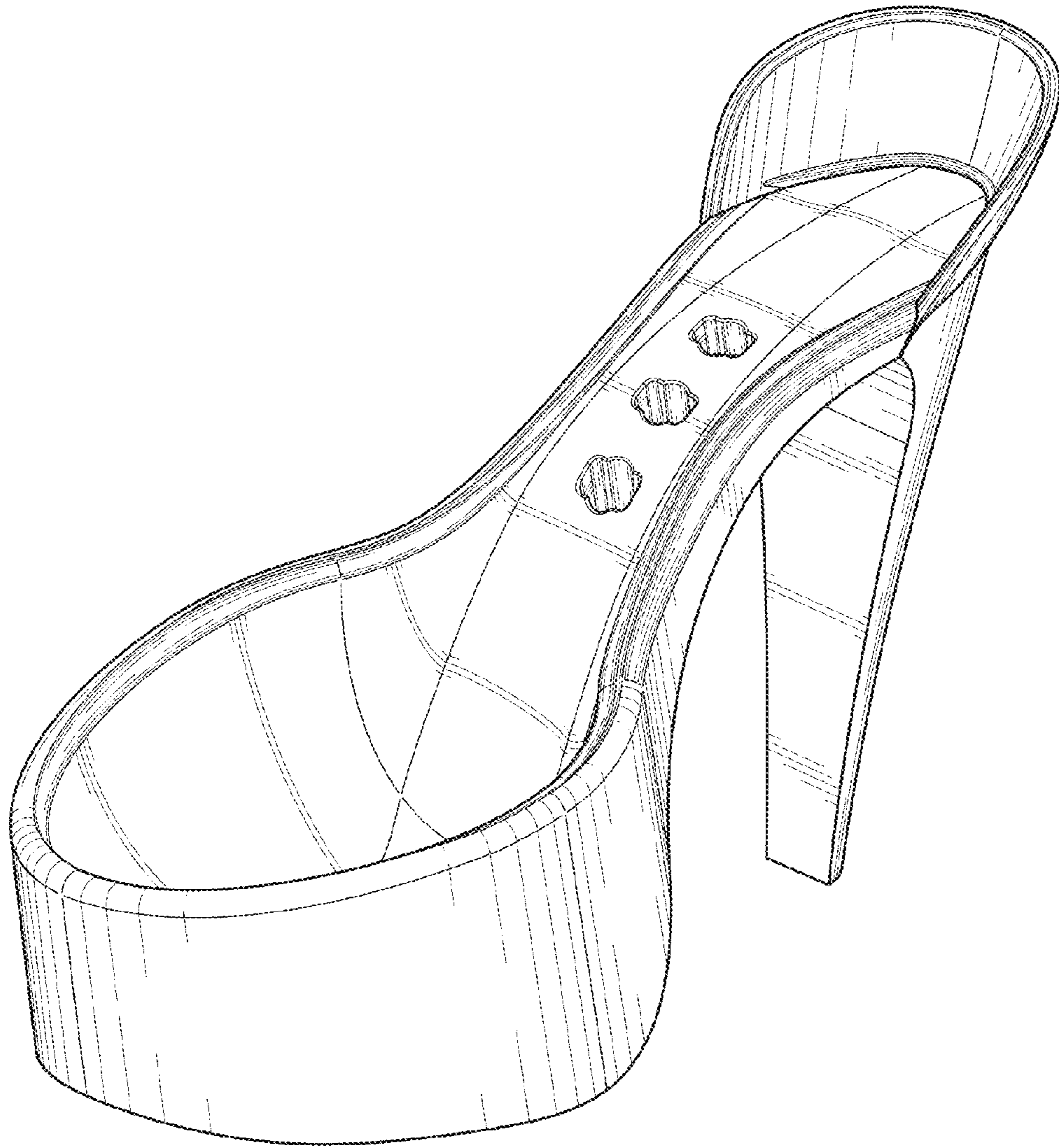

FIG. 1

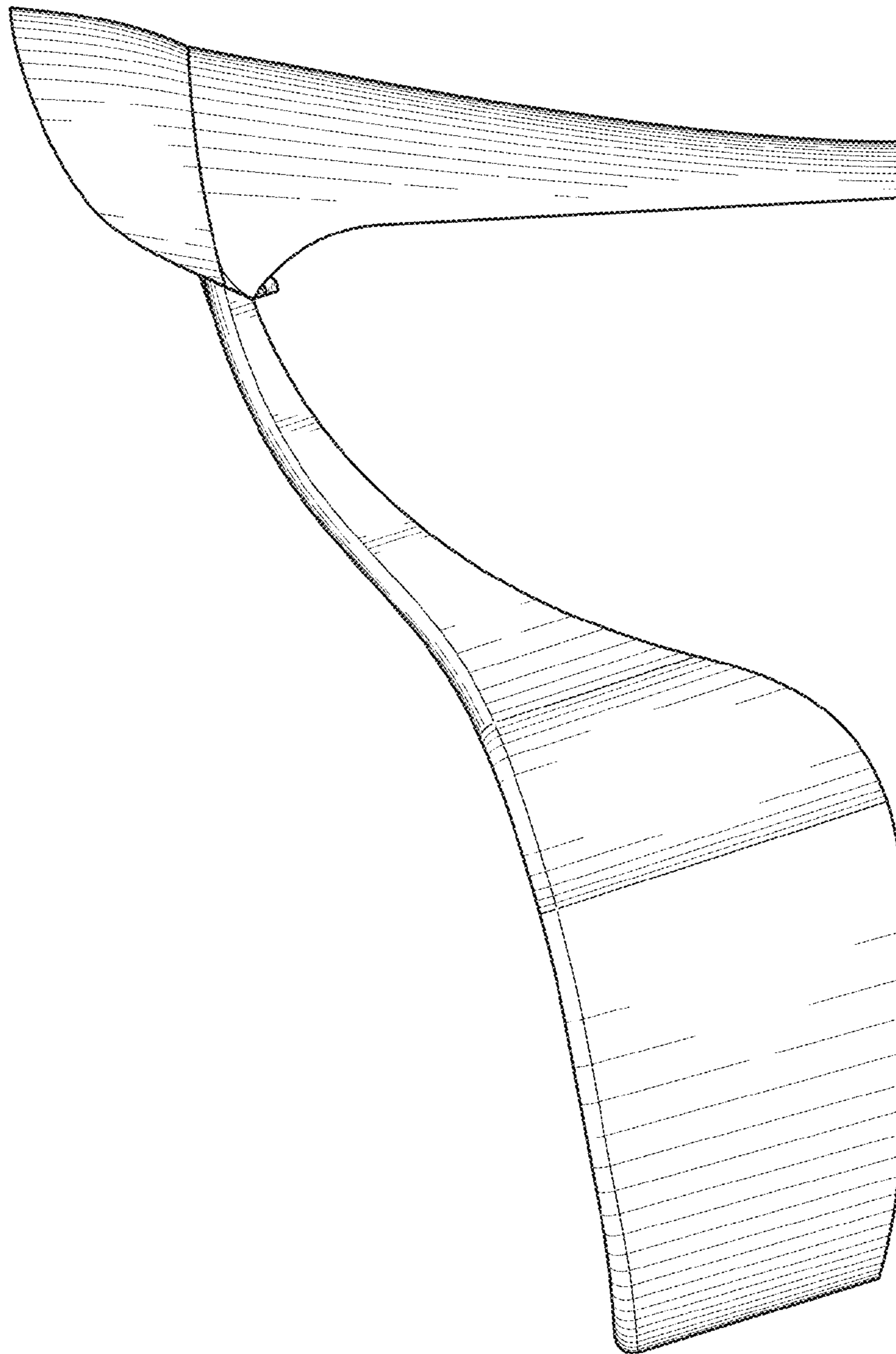

FIG. 2

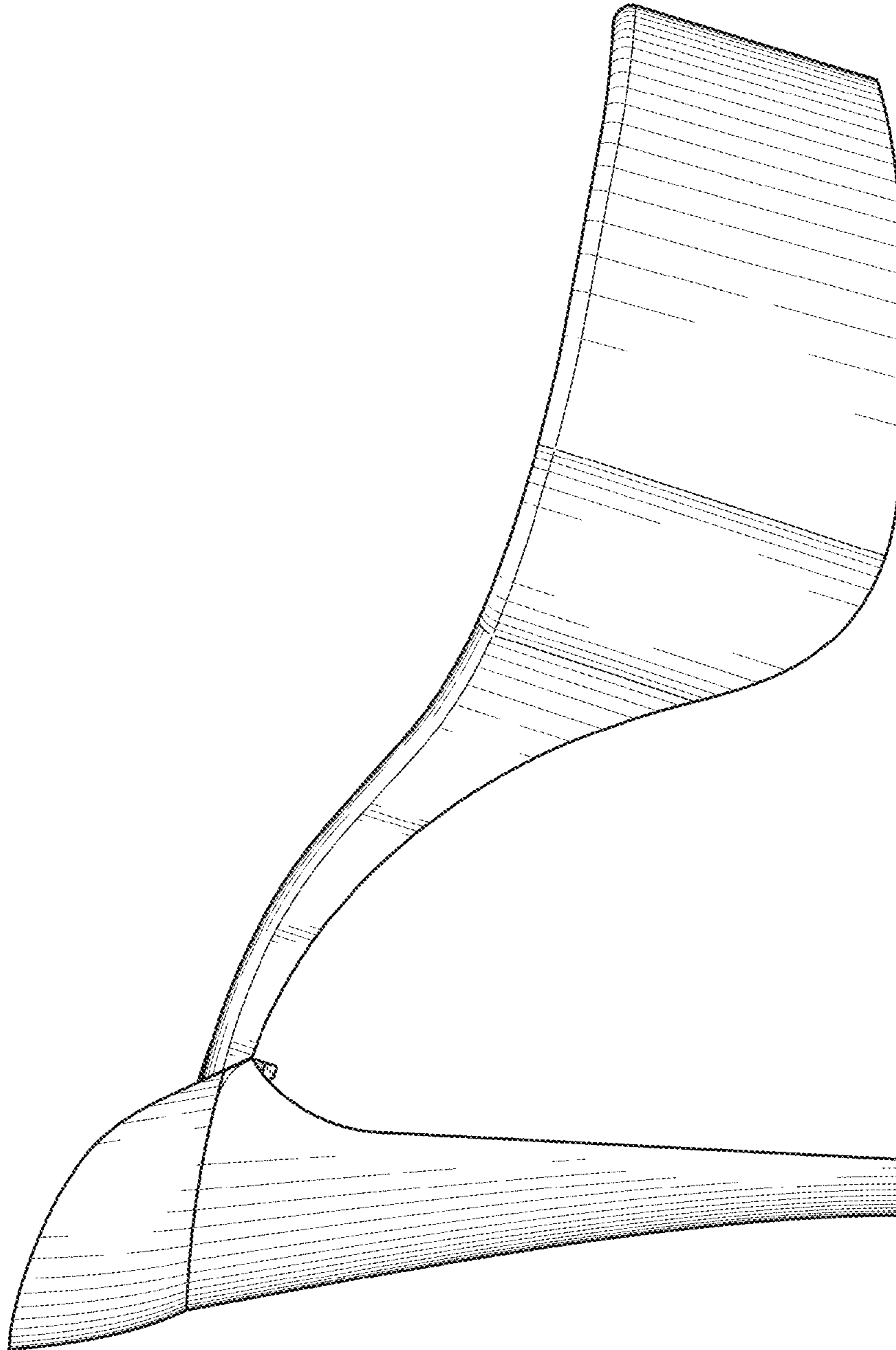

FIG. 3

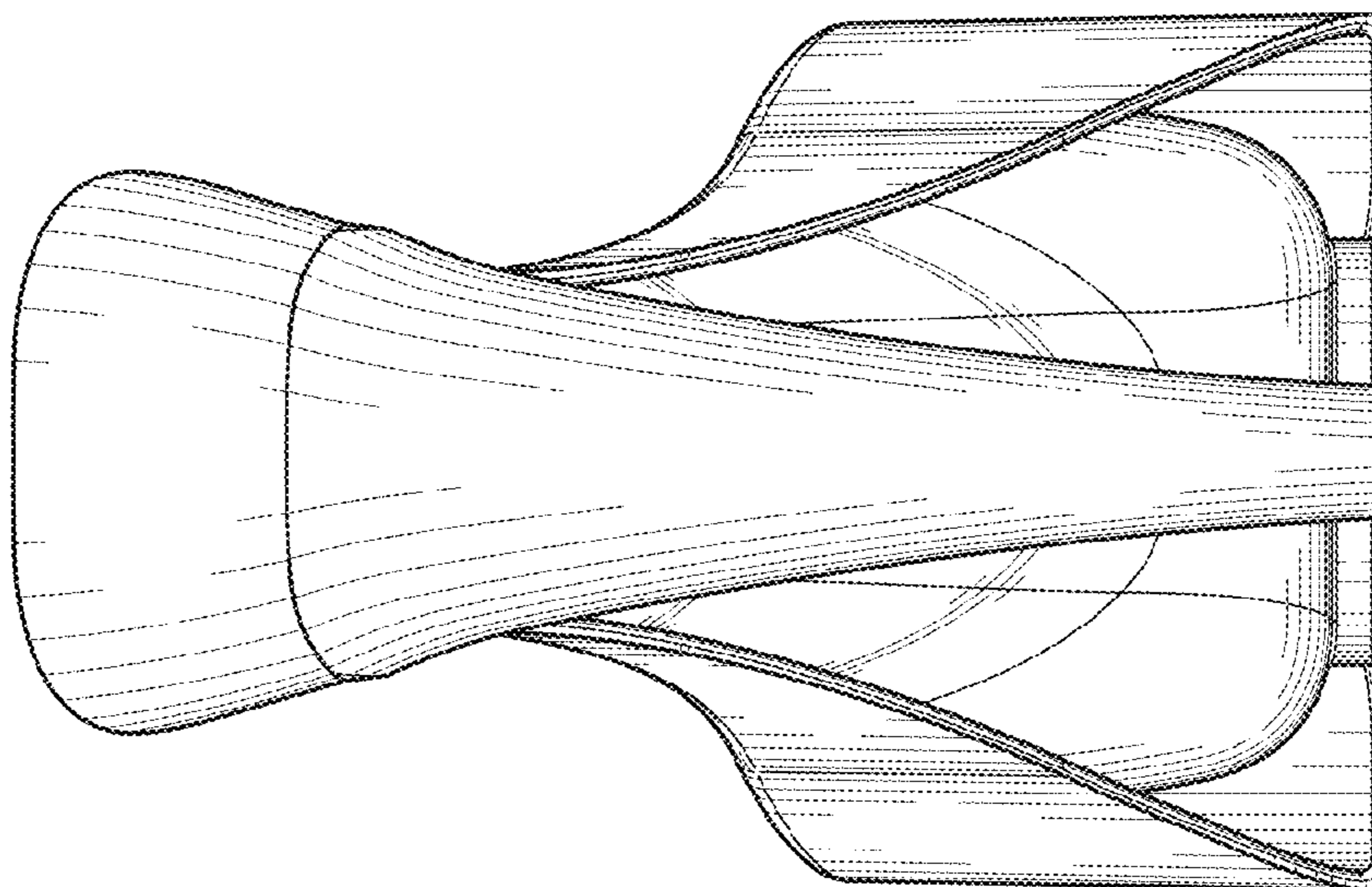

FIG. 5

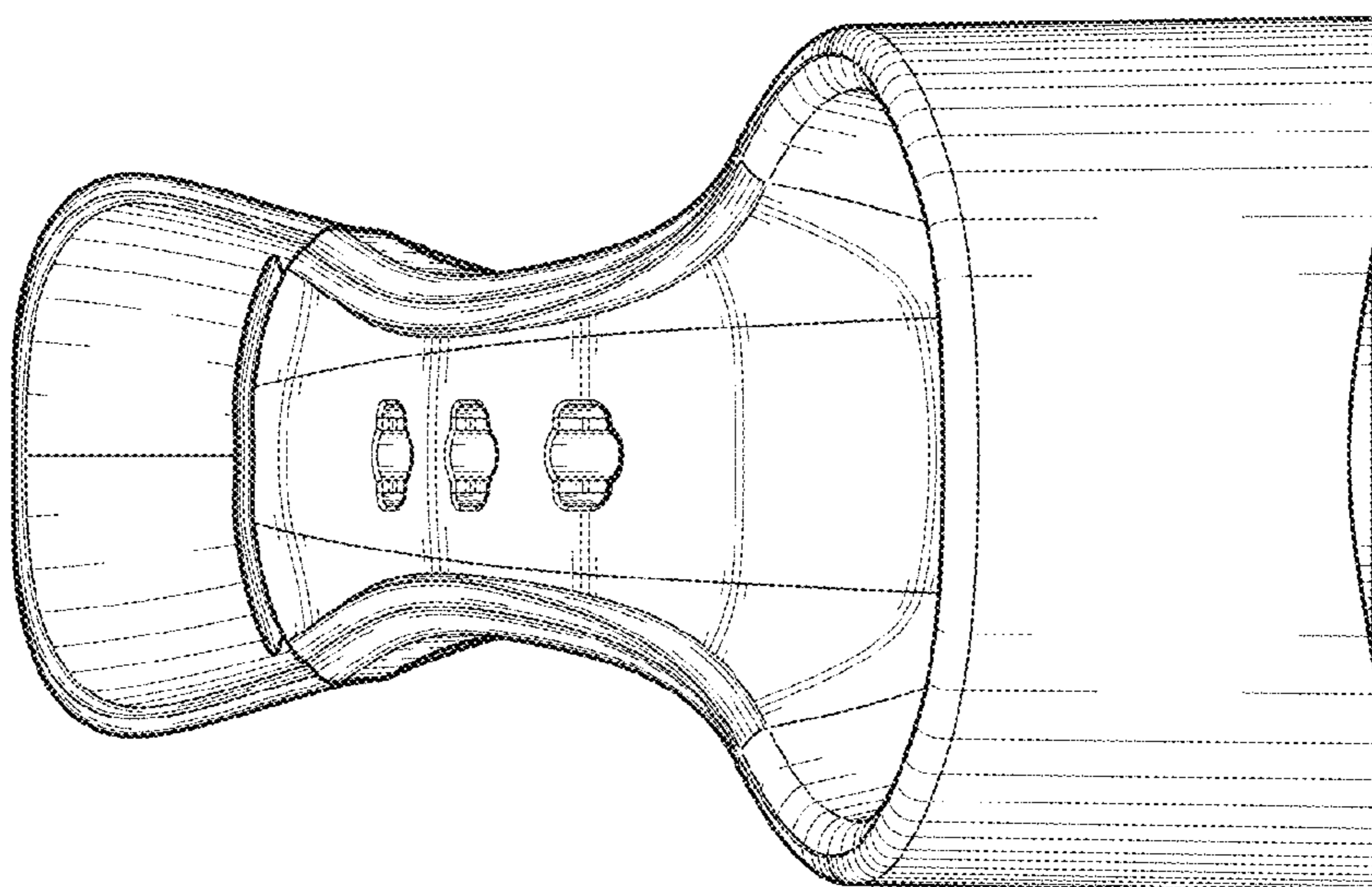

FIG. 4

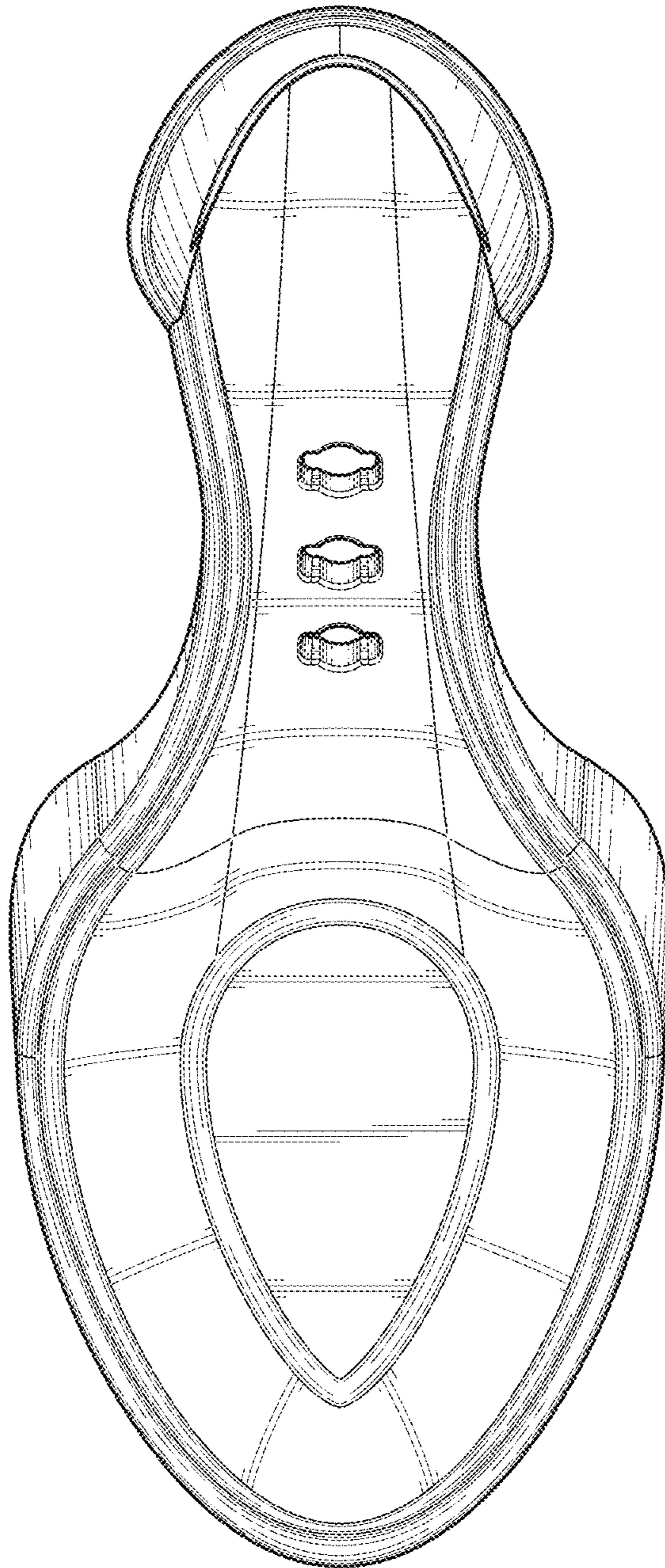

FIG. 6

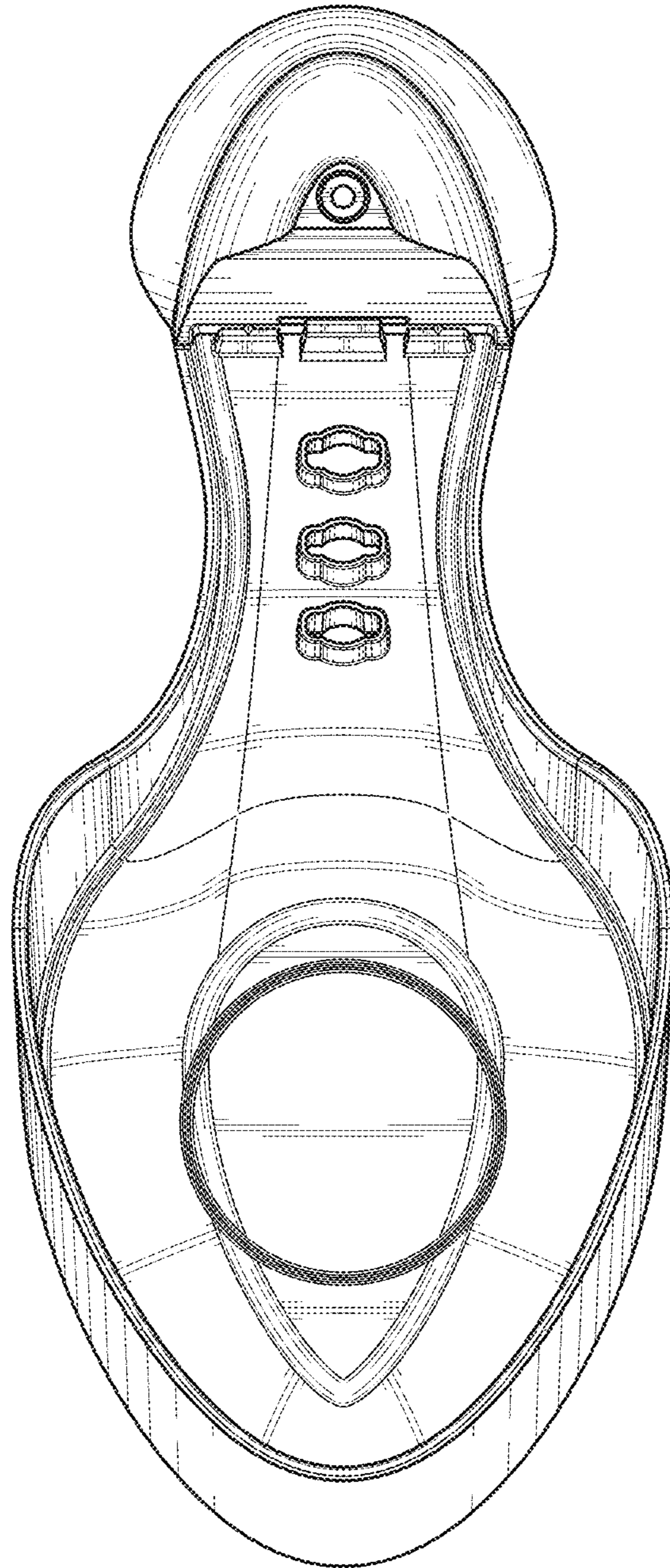

FIG. 7

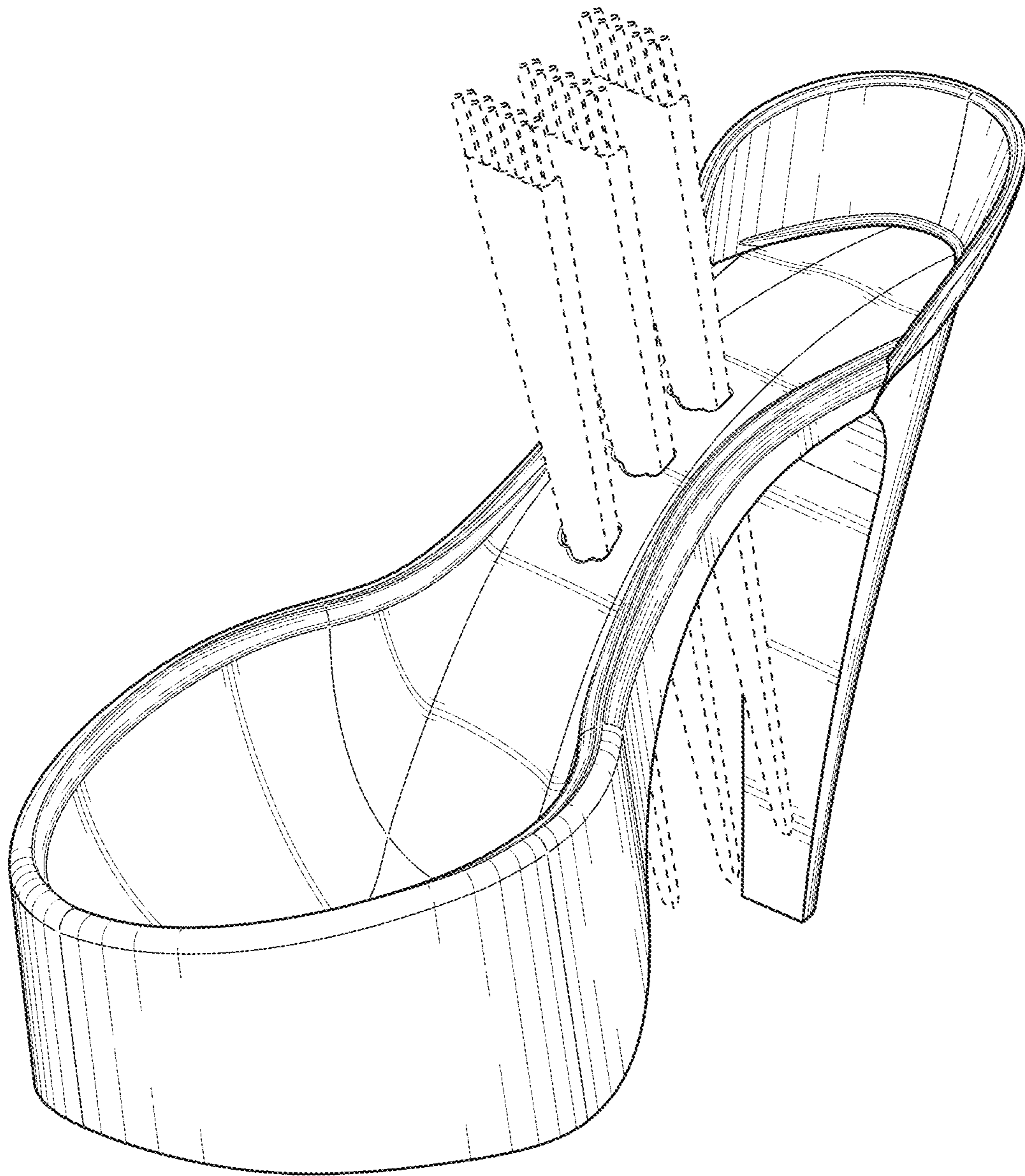

FIG. 8