



US00D752393S

(12) **United States Design Patent**
Boyden

(10) **Patent No.:** **US D752,393 S**
(45) **Date of Patent:** **** Mar. 29, 2016**

(54) **BOWL**

(71) Applicant: **Andrew Boyden**, Fort Wayne, IN (US)

(72) Inventor: **Andrew Boyden**, Fort Wayne, IN (US)

(**) Term: **14 Years**

(21) Appl. No.: **29/506,952**

(22) Filed: **Oct. 22, 2014**

(51) **LOC (10) Cl.** **07-01**

(52) **U.S. Cl.**

USPC **D7/559; D7/567; D7/571; D7/515**

(58) **Field of Classification Search**

USPC D7/523, 532, 507, 509, 514, 515, 524,
D7/564, 559, 551.1, 544, 567, 571, 536,
D7/533, 625, 619.2, 689, 651; 220/713,
220/703, 592.16; D2/918, 930, 925, 931,
D2/950; D19/91; D30/129, 102

CPC . A47G 19/2205; A47G 19/02; B67D 1/0418;
A24F 3/00

See application file for complete search history.

(56) **References Cited**

U.S. PATENT DOCUMENTS

D103,180 S *	2/1937	McCain	D2/930
D131,570 S *	3/1942	Vivier	D2/930
D232,209 S	7/1974	Edwards		
D255,843 S *	7/1980	Goldman	D2/950
D264,417 S	5/1982	Urda, Jr. et al.		
D349,217 S	8/1994	Spencer		
D387,192 S *	12/1997	Srourian	D2/947
D512,879 S *	12/2005	Haakenson	D7/619.2
7,040,678 B1	5/2006	Haakenson		
D523,086 S *	6/2006	Jones	D19/91
D523,480 S *	6/2006	Jones	D19/91
D523,481 S *	6/2006	Jones	D19/91
D529,264 S *	10/2006	Choi	D2/930
D535,155 S *	1/2007	Leahy	D7/619.2
D558,437 S *	1/2008	Wilkinson	D2/971

D562,540 S *	2/2008	Guers-Neyrud	D2/971
D567,024 S	4/2008	Yeh		
D567,599 S *	4/2008	Kushner	D7/651
D578,831 S	10/2008	Loibl et al.		
D582,637 S *	12/2008	Guers-Neyraud	D2/925
D595,543 S *	7/2009	Mandel	D2/910
D626,793 S *	11/2010	Horwitz	D7/642
D647,370 S *	10/2011	van Dijk	D11/150
D677,988 S *	3/2013	Eubank	D2/910
D718,986 S *	12/2014	Sekse	D7/651
D718,987 S *	12/2014	Sekse	D7/651
D741,052 S *	10/2015	Guers-Neyraud	D2/925

FOREIGN PATENT DOCUMENTS

EP 1763992 3/2007

OTHER PUBLICATIONS

Sinderalla High Heel Serving Dish, <http://www.rousseau.co.uk/high-heel-nibbles-holder/> p. 1, last checked Sep. 25, 2014.

(Continued)

Primary Examiner — Marianne Pandozzi

(57) **CLAIM**

The ornamental design for a bowl, as shown and described.

DESCRIPTION

FIG. 1 is a perspective view of a bowl in accordance with the present invention;

FIG. 2 is a left side view thereof;

FIG. 3 is a right side view thereof;

FIG. 4 is a top view thereof;

FIG. 5 is a bottom view thereof,

FIG. 6 is a rear view thereof; and,

FIG. 7 is a front view thereof.

The nature and intended use of the claimed design is for a bowl, such as a food bowl, water dish, pet food bowl or the like.

1 Claim, 4 Drawing Sheets

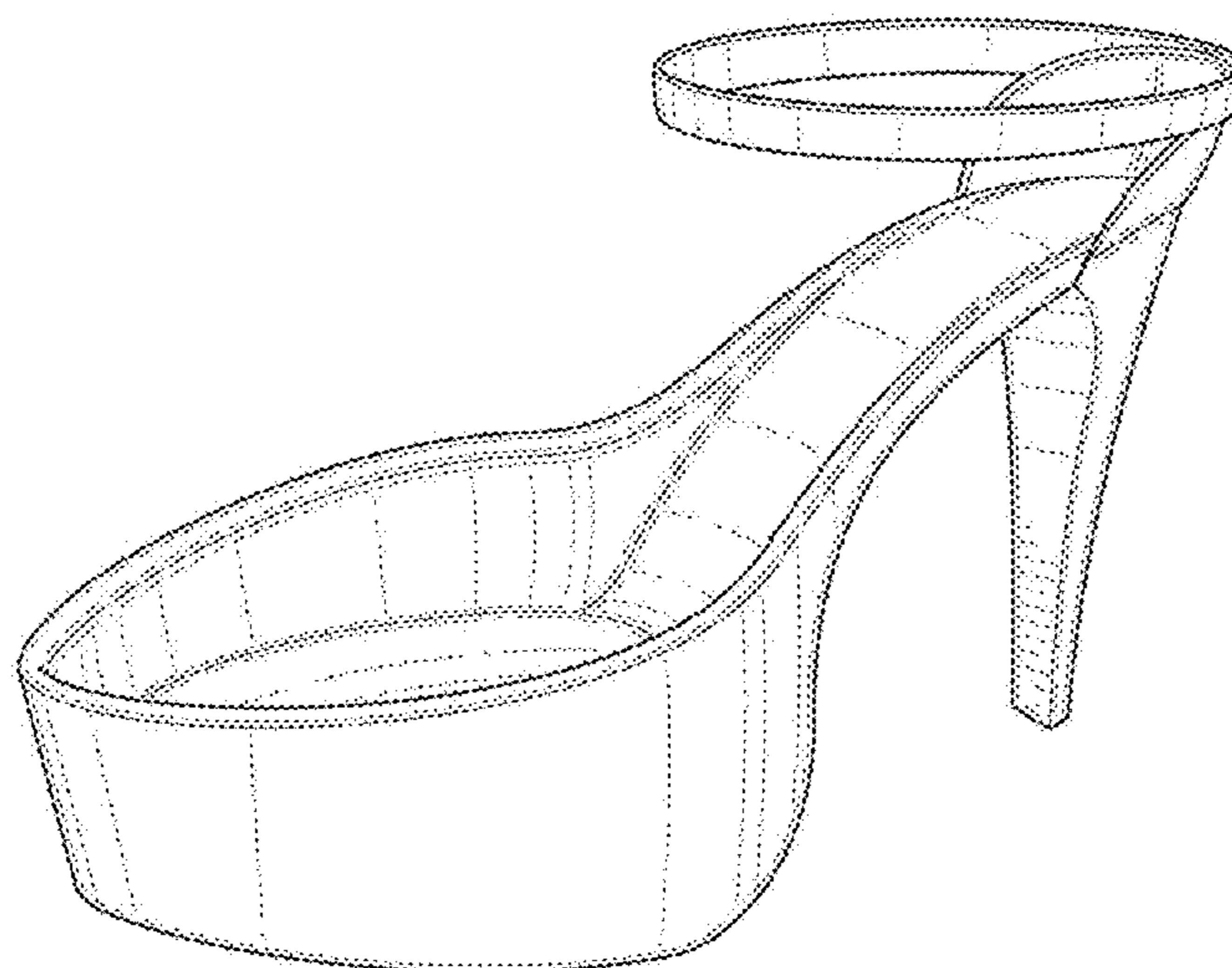

(56)

References Cited

OTHER PUBLICATIONS

High Heel Party Serveware Candy Dish, <http://www.etsy.com/listing/37326199/high-heel-party-serve-ware-candy-dish> p. 1, last checked Sep. 25, 2014.

Shimmer and Shine Wine Holder, <http://www.homewetbar.com/shimmer-and-shine-shoe-wine-holder-p-3772.html?osCsid=a5493b780791bacca3514907e045166> p. 1, last viewed Sep. 25, 2014.

High Hell Cell Phone Holder, <https://www.creative-hobbies.com/4208-high-heel-cell-phone-holder-4-high-x-5-3-4-long.html> p. 1, last checked Sep. 25, 2014.

Shoe Butter Dish, <http://www.jonathanadler.com/Shoe-Butter-Dish/> p. 1, last checked Sep. 25, 2014.

Patience Brewster—High Heel Shoe Serving Tray, <http://www.woodenduckshoppe.com/shoppe/patience-brewster-high-heel-shoe-serving-plate.html> p. 1, last checked on Sep. 25, 2014.

* cited by examiner

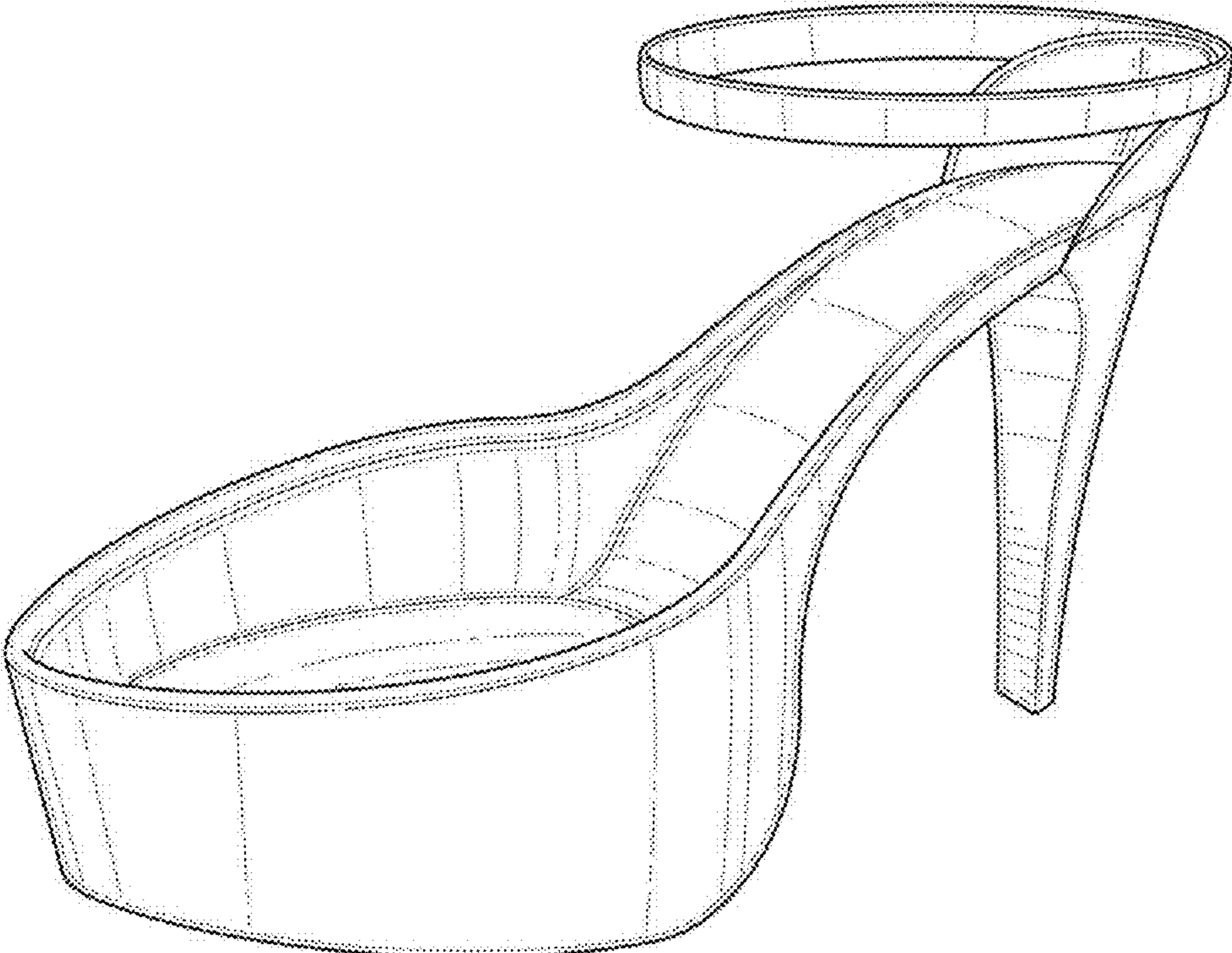

FIG. 1

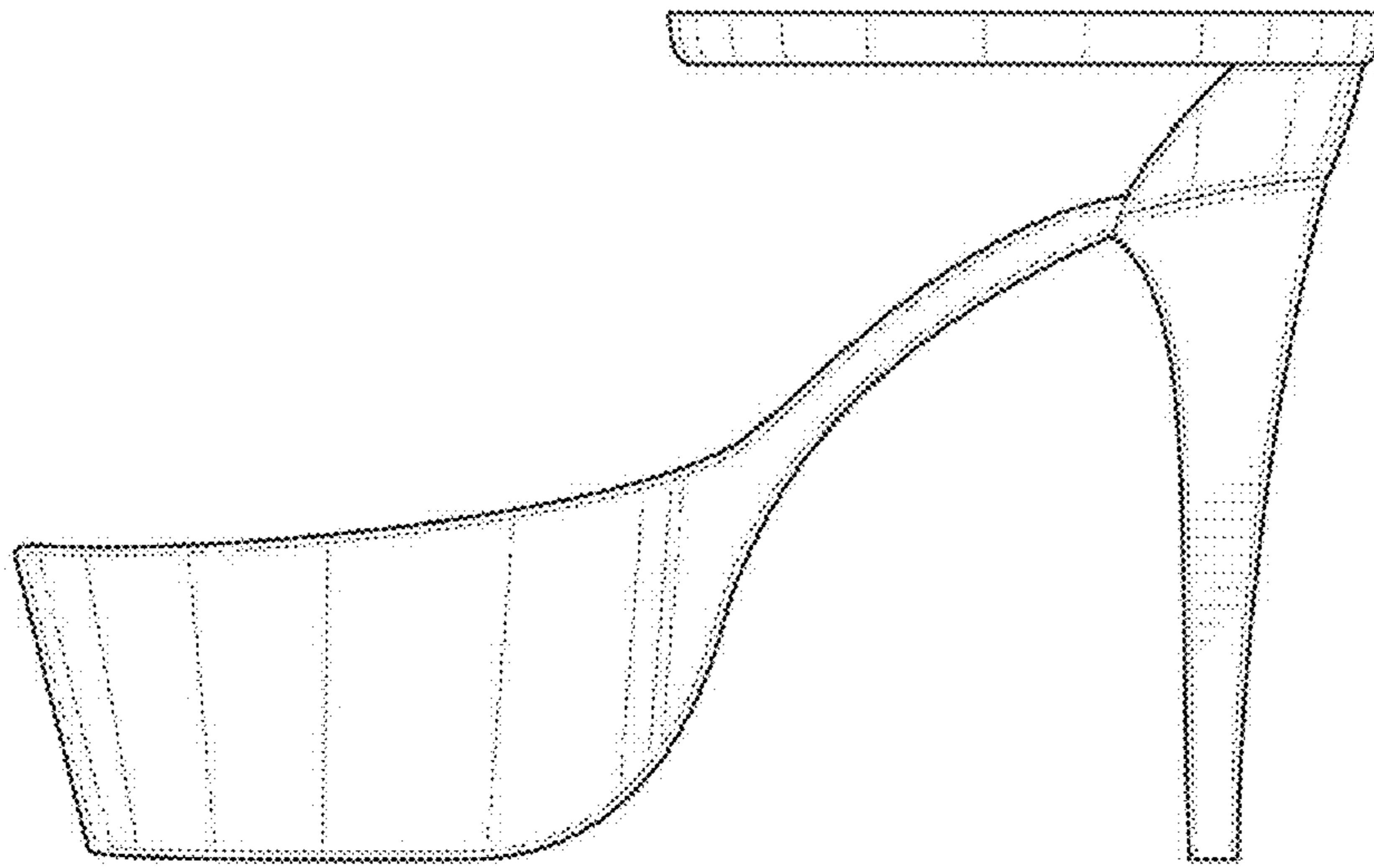

FIG. 2

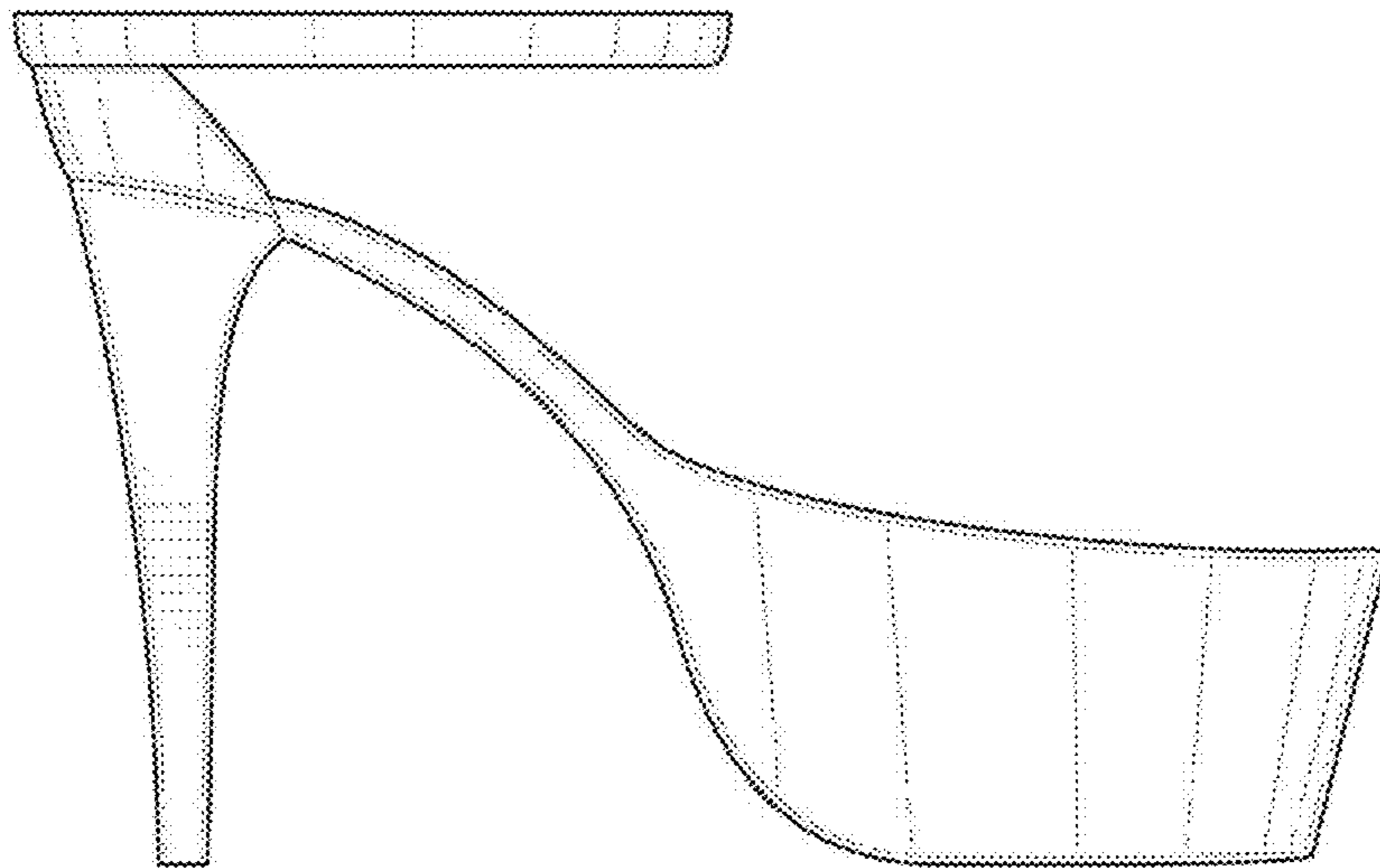

FIG. 3

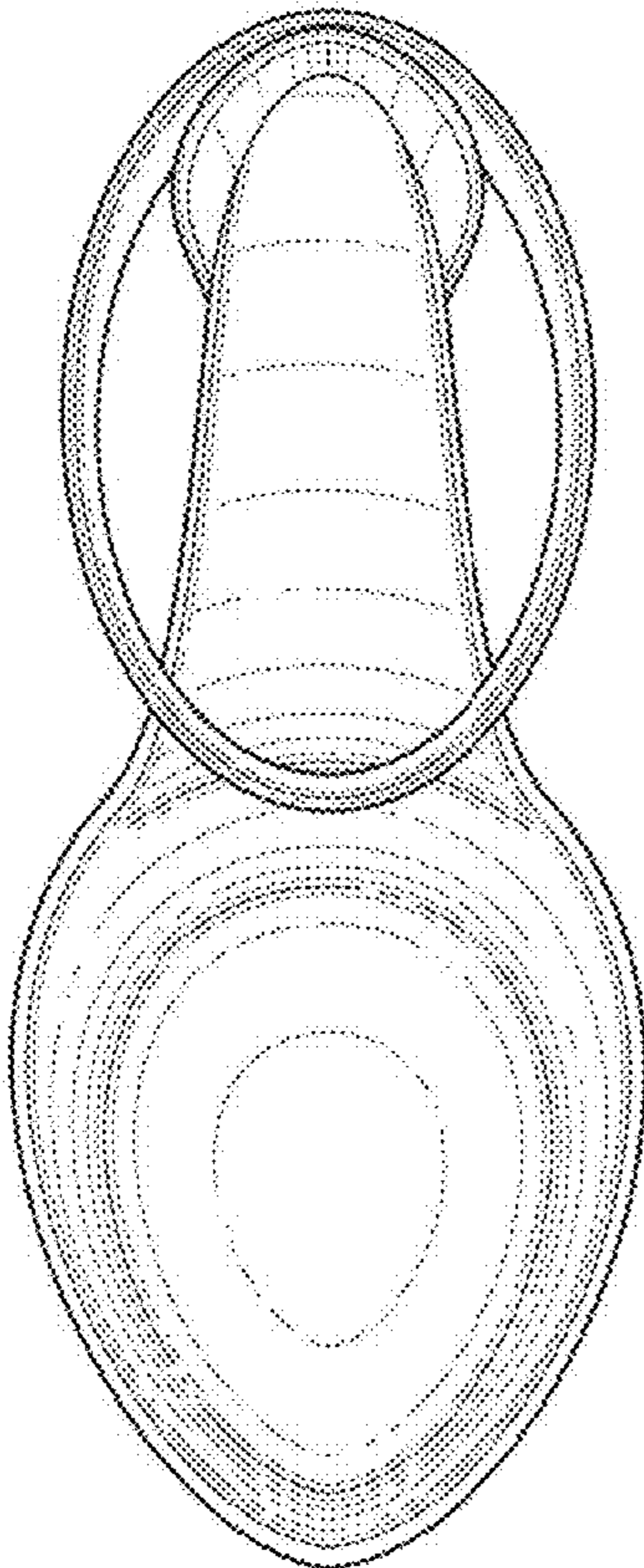

FIG. 4

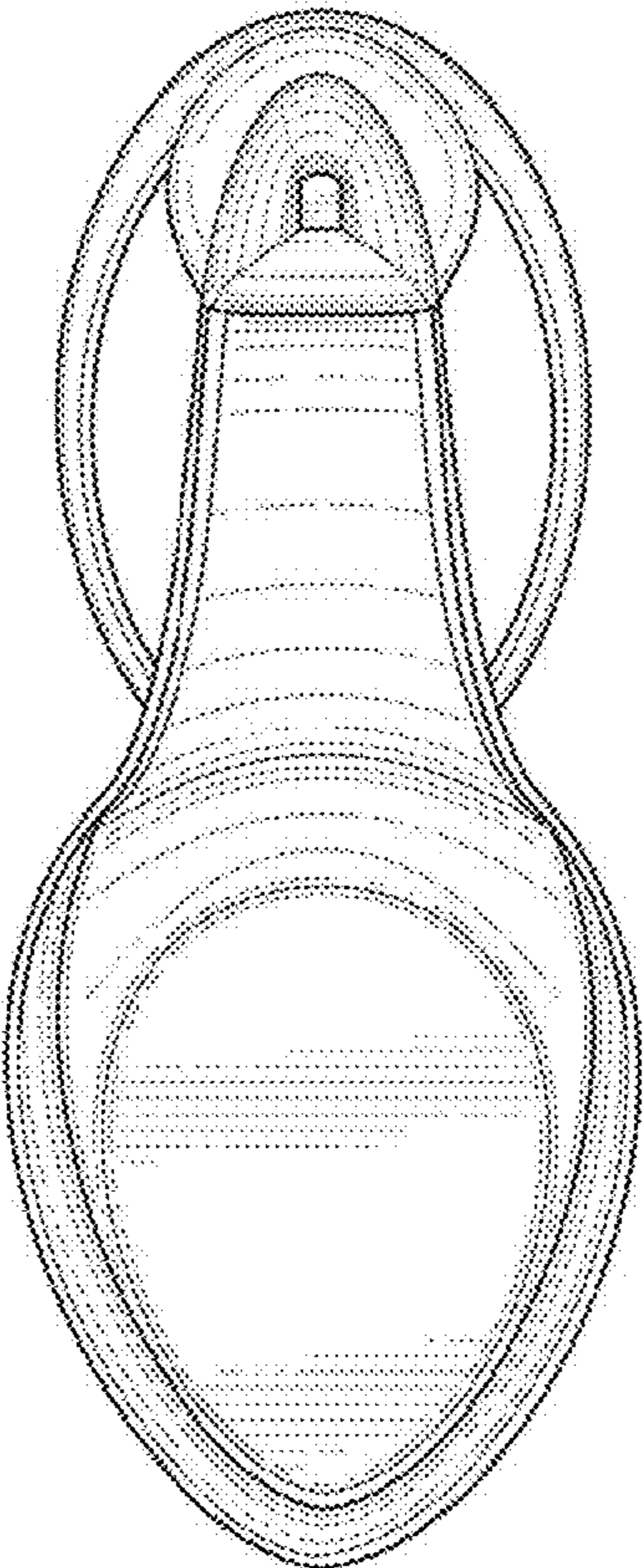

FIG. 5

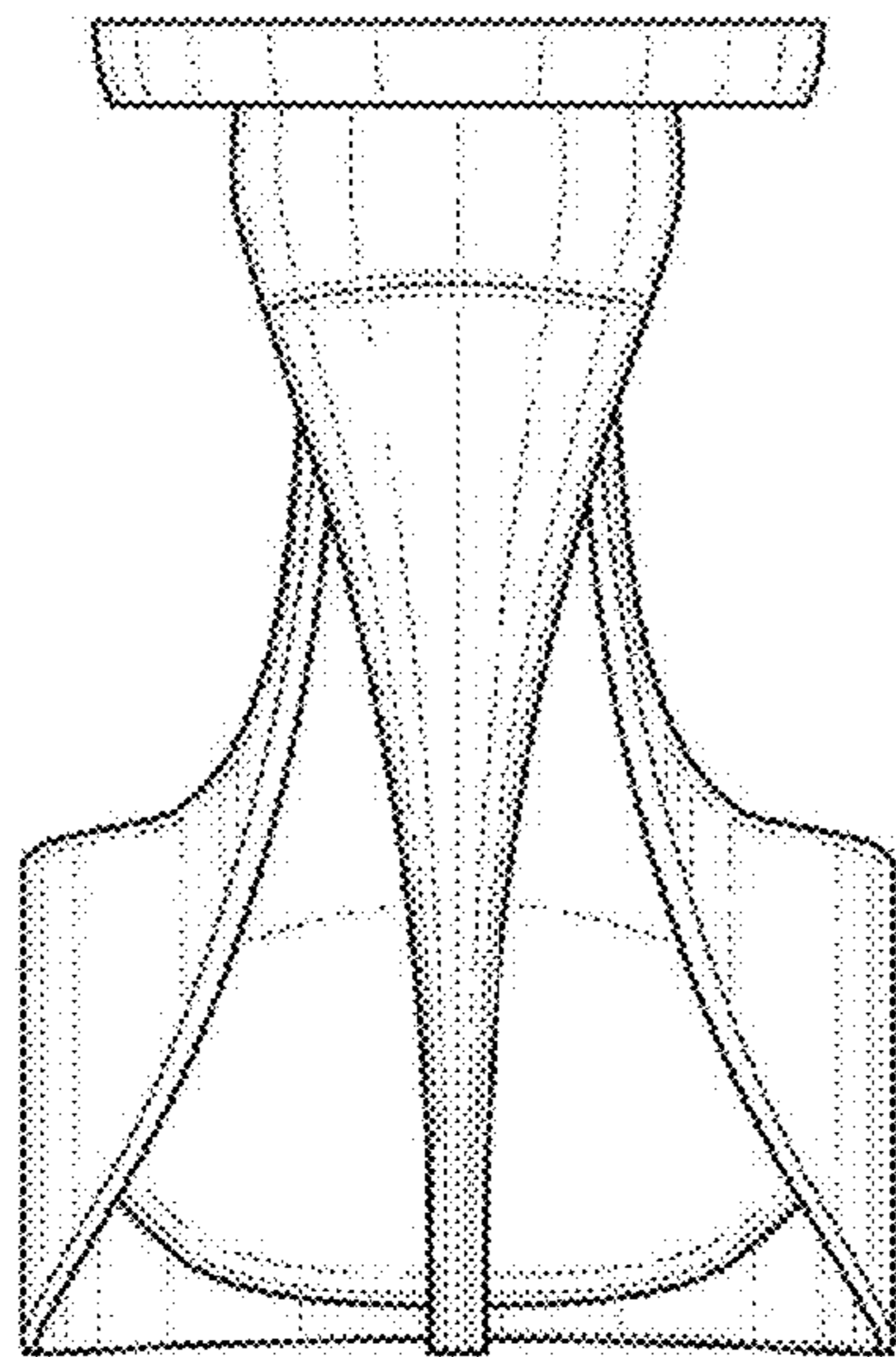

FIG. 6

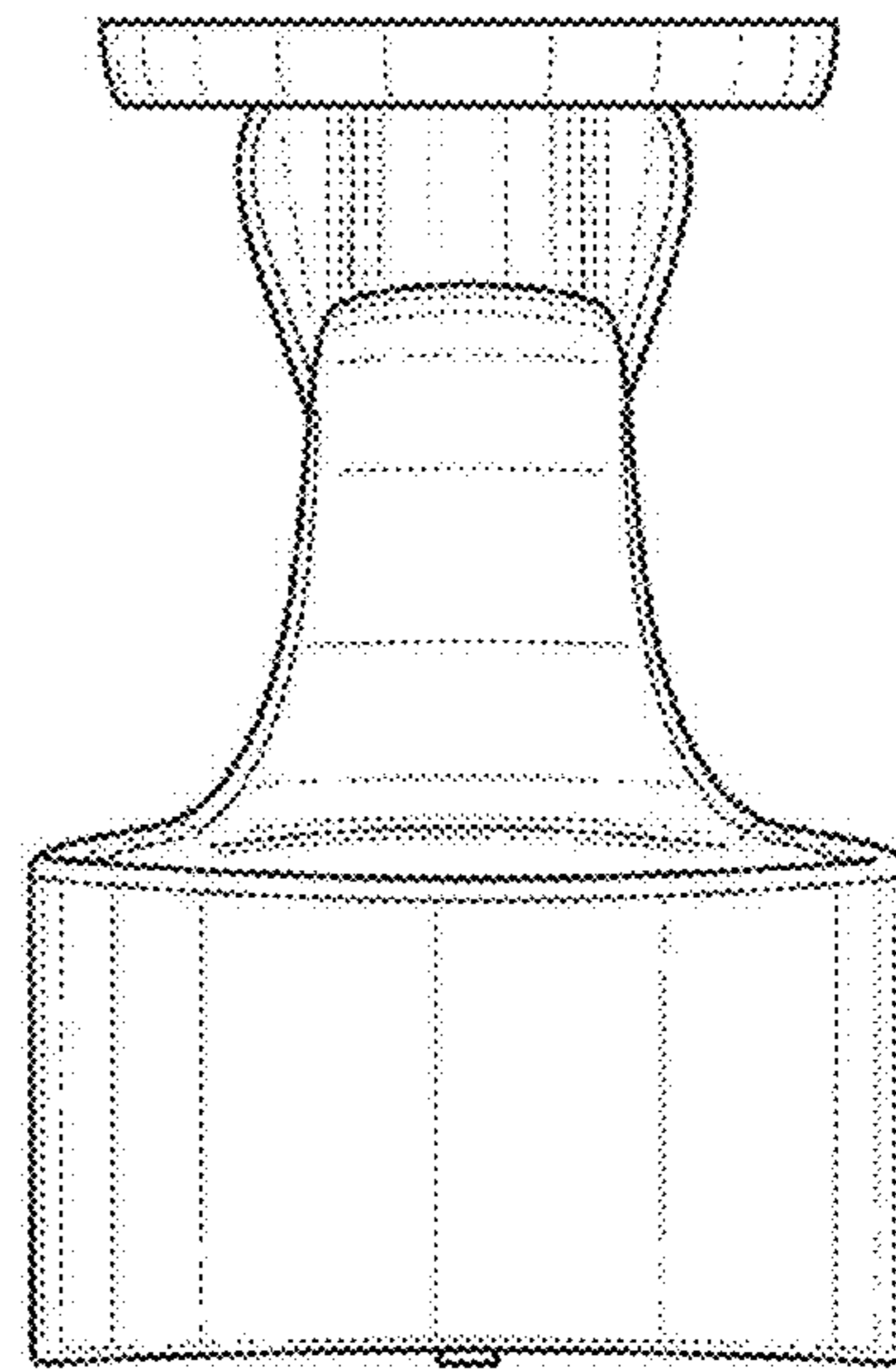

FIG. 7