



US00D752365S

(12) **United States Design Patent**
Knoll

(10) **Patent No.:** **US D752,365 S**
(45) **Date of Patent:** **** Mar. 29, 2016**

- (54) **STAND**
- (71) Applicant: **Target Brands, Inc.**, Minneapolis, MN (US)
- (72) Inventor: **Mitchell Knoll**, Eagan, MN (US)
- (73) Assignee: **Target Brands, Inc.**, Minneapolis, MN (US)
- (**) Term: **14 Years**
- (21) Appl. No.: **29/490,404**
- (22) Filed: **May 9, 2014**
- (51) **LOC (10) Cl.** **06-04**
- (52) **U.S. Cl.**
USPC **D6/661**
- (58) **Field of Classification Search**
USPC D6/657, 660, 661, 672, 675, 675.1, 698, D6/699
CPC A47B 43/00; A47B 43/02; G07G 1/0018; A47F 5/10; A47F 5/11; A47F 5/112; A47F 5/116; B65D 5/5007; B65D 5/5009
See application file for complete search history.

- 6,837,378 B2 * 1/2005 Mason A47F 5/112 206/738
- D631,264 S * 1/2011 Kruse D6/699
- 8,201,726 B2 6/2012 Scott et al.
- 9,060,601 B2 * 6/2015 Landry A47B 43/00
- 9,089,206 B2 * 7/2015 Baylor A47B 43/00

OTHER PUBLICATIONS

Office Action from Canadian Patent Application No. 157,190, mailed Dec. 4, 2014 (1 page).

* cited by examiner

Primary Examiner — Mimososa De

(74) *Attorney, Agent, or Firm* — Leanna Taveggia Farrell; Westman, Champlin & Koehler, P.A.

(57) **CLAIM**

The ornamental design for a stand, as shown and described.

DESCRIPTION

FIG. 1 is a perspective view of a stand showing my new design;
 FIG. 2 is a front view thereof;
 FIG. 3 is a back view thereof;
 FIG. 4 is a left side view thereof;
 FIG. 5 is a right side view thereof;
 FIG. 6 is a top view thereof;
 FIG. 7 is a bottom view thereof;
 FIG. 8 is a perspective view of the stand of FIG. 1 in an alternative position;
 FIG. 9 is a front view of FIG. 8;
 FIG. 10 is a back view of FIG. 8;
 FIG. 11 is a left side view of FIG. 8;
 FIG. 12 is a right side view of FIG. 8;
 FIG. 13 is a top view of FIG. 8; and,
 FIG. 14 is a bottom view of FIG. 8.
 The broken lines illustrate portions of the stand and form no part of the claimed design.

(56) **References Cited**

U.S. PATENT DOCUMENTS

- D97,616 S * 11/1935 Rockola D6/699
- 2,321,473 A * 6/1943 Ferguson B65D 5/5007 206/783
- D201,085 S * 5/1965 Anderson D6/675.1
- 3,664,493 A * 5/1972 Dutcher B65D 5/5009 206/779
- 3,987,737 A * 10/1976 Smith A47F 5/116 108/179
- 4,646,922 A * 3/1987 Smith A47F 5/116 211/132.1
- 4,723,664 A * 2/1988 Smith A47F 5/112 211/132.1
- 6,302,283 B1 * 10/2001 Yeh A47F 5/116 108/109

1 Claim, 6 Drawing Sheets

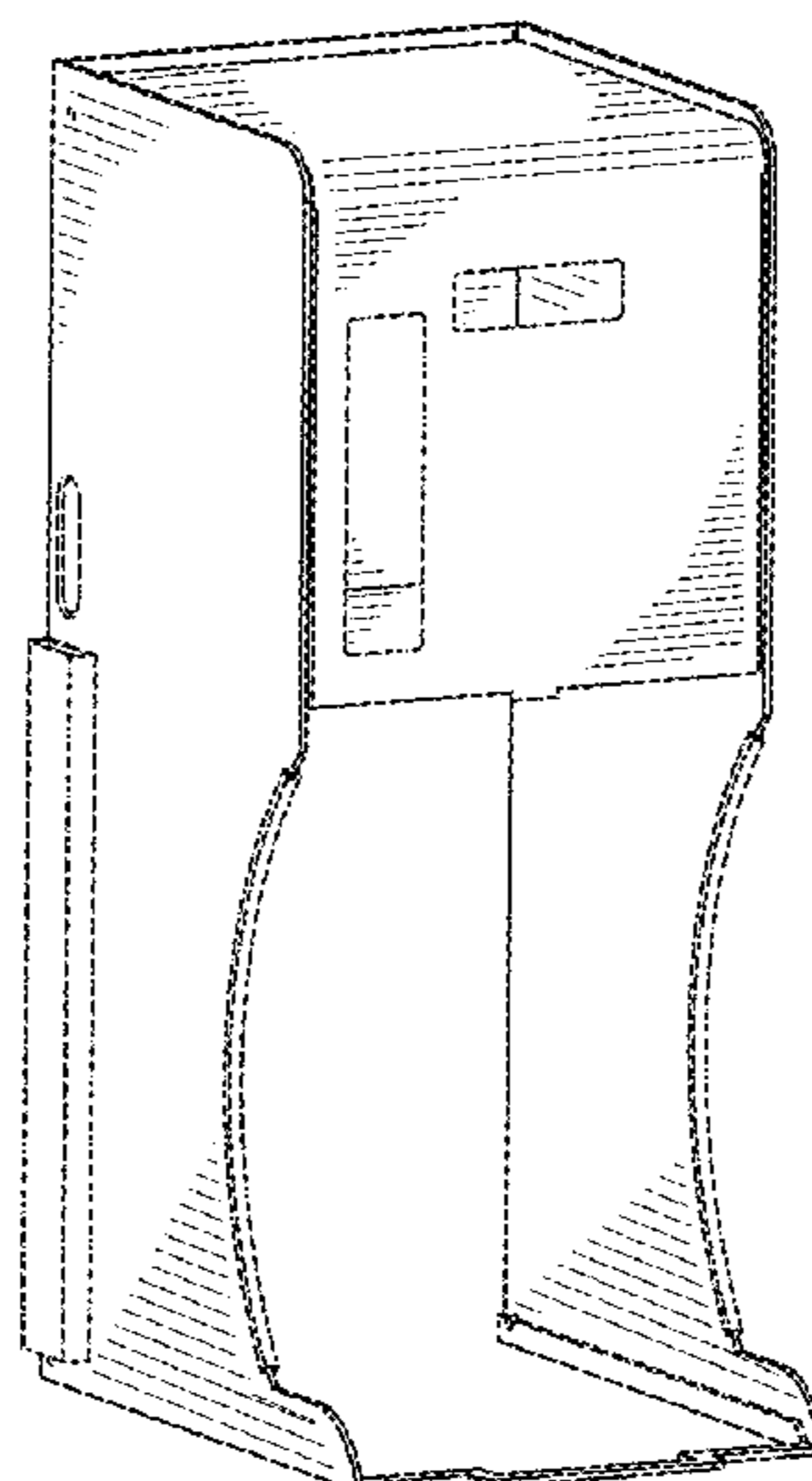

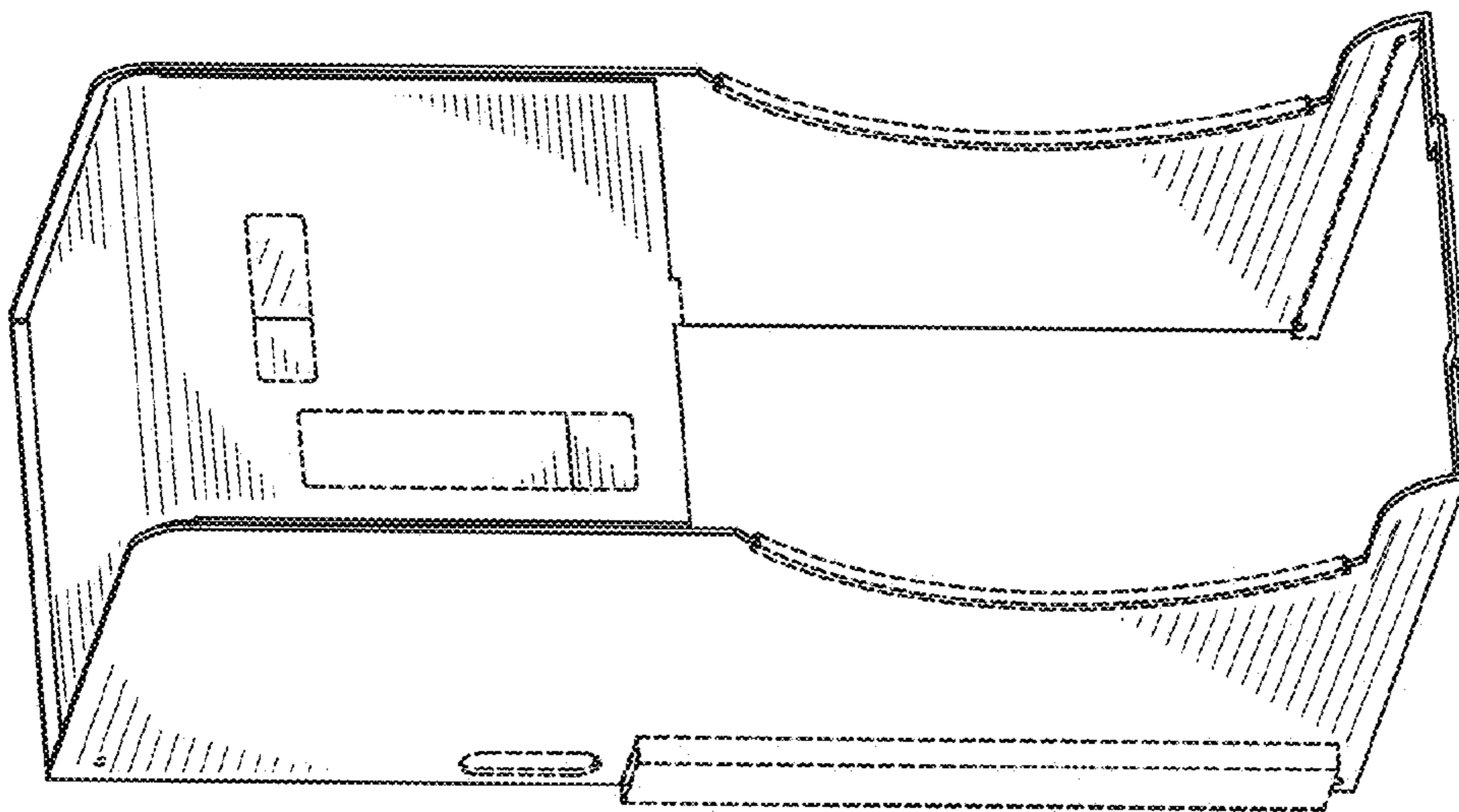

Fig. 1

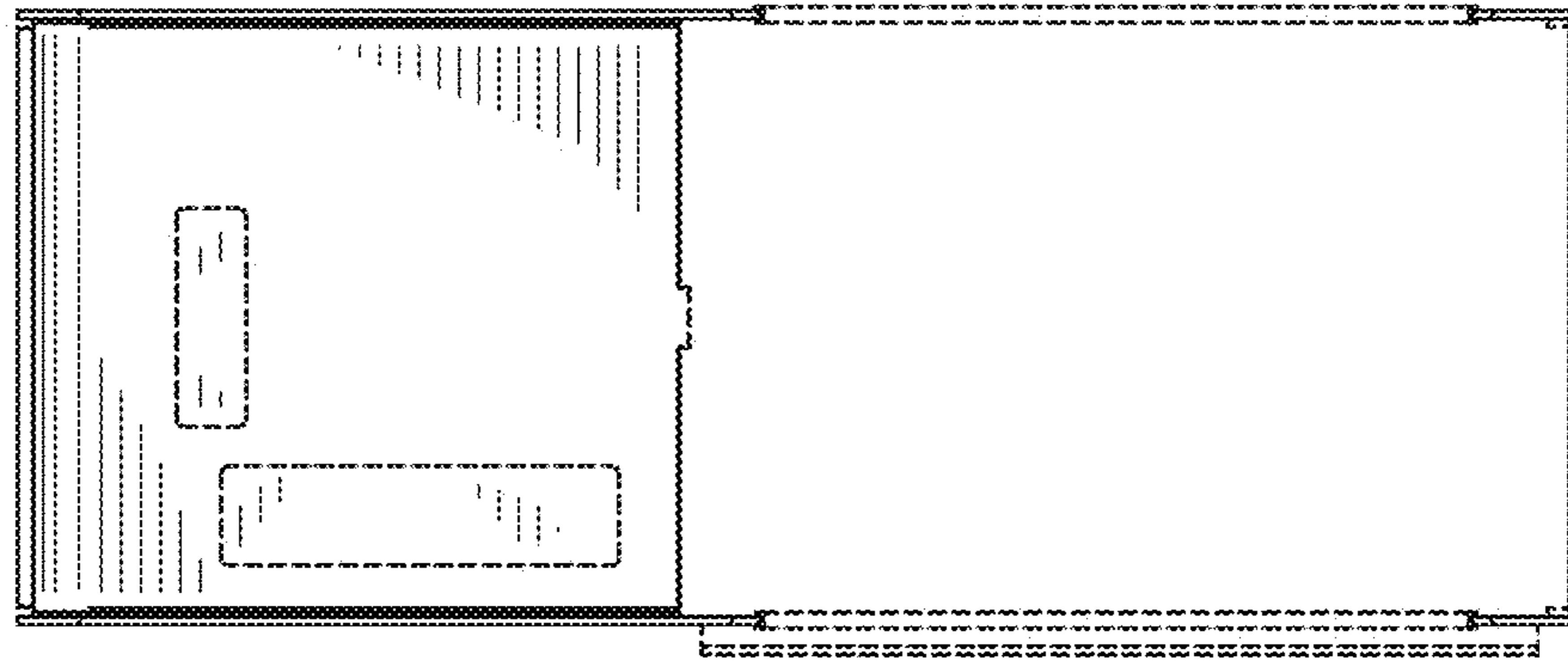

Fig. 2

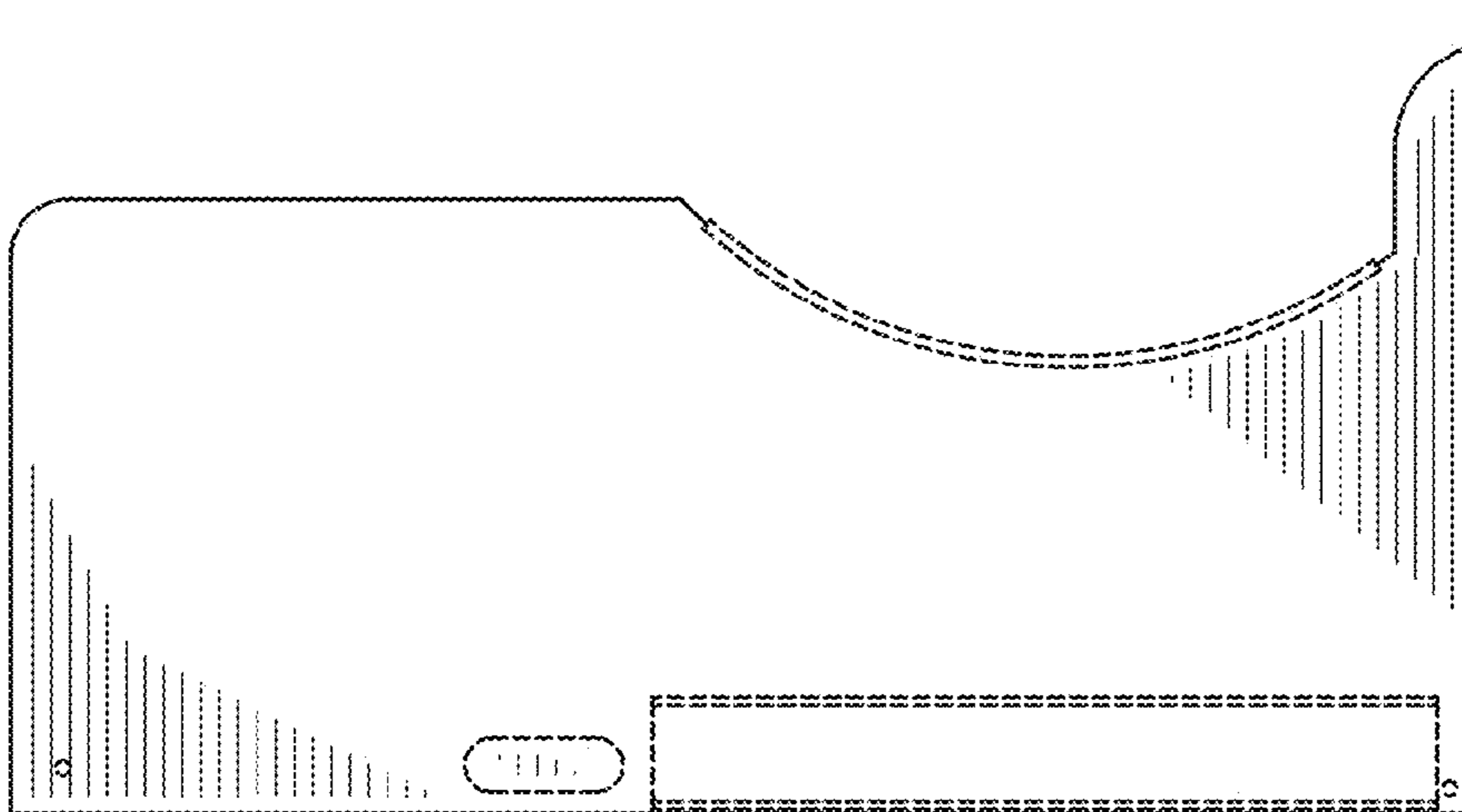

Fig. 4

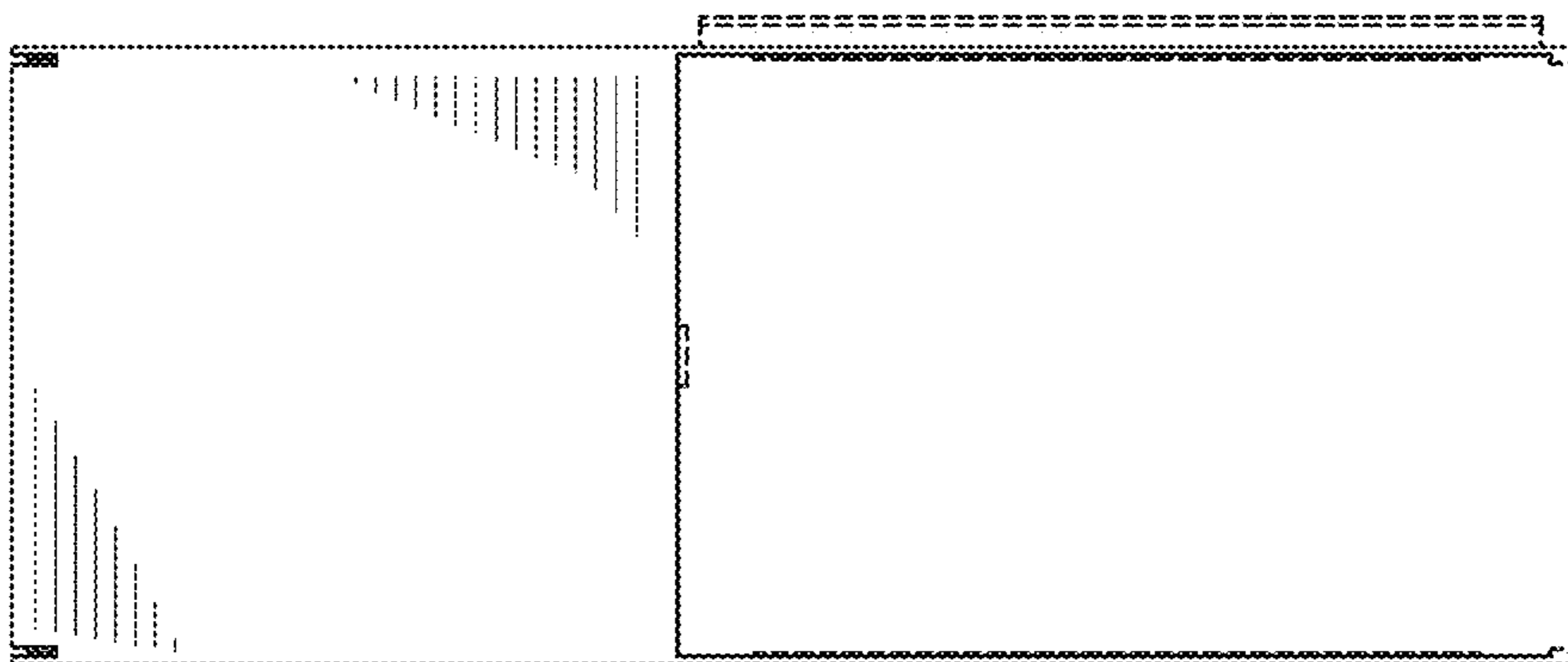

Fig. 3

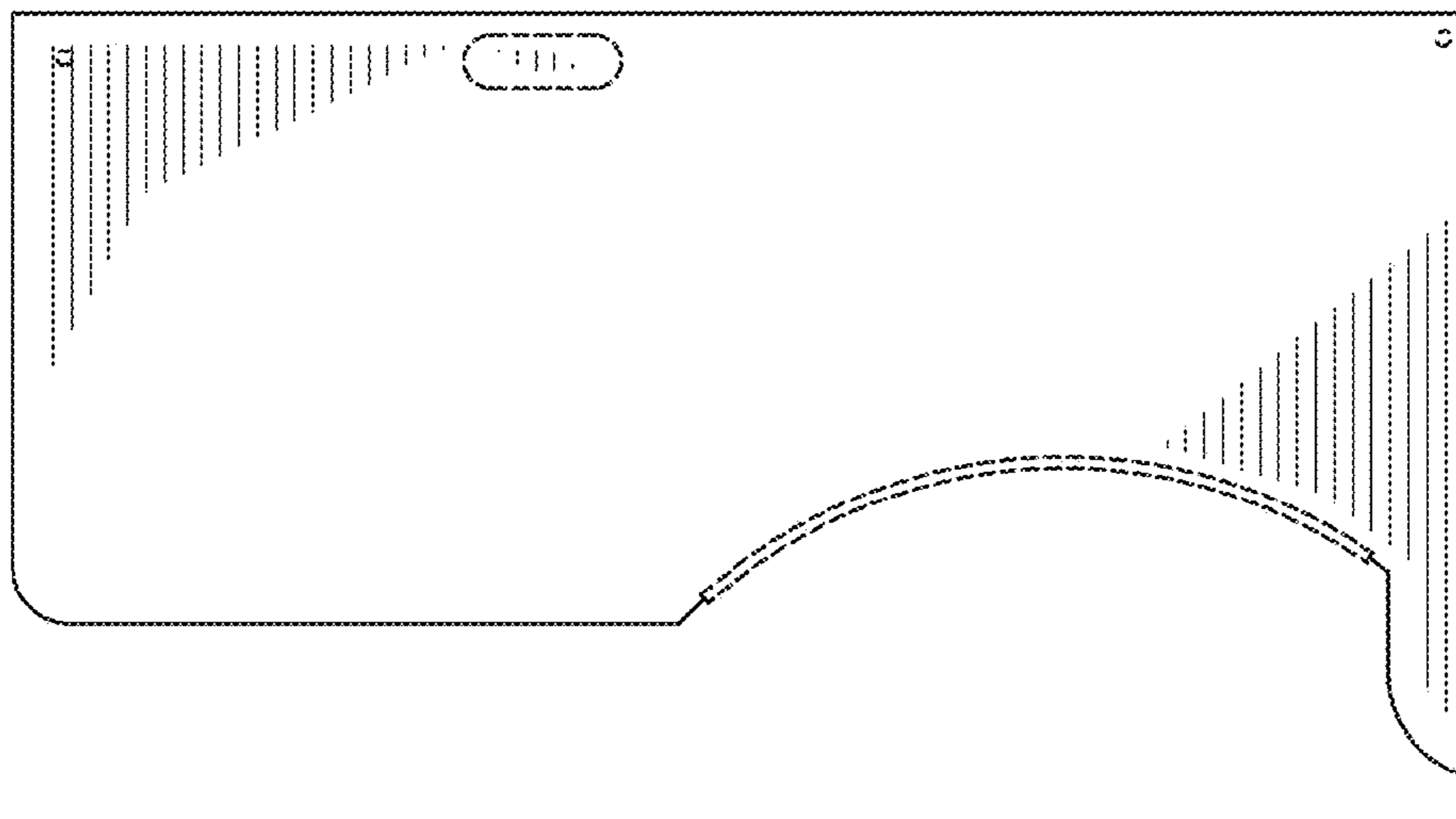

Fig. 5

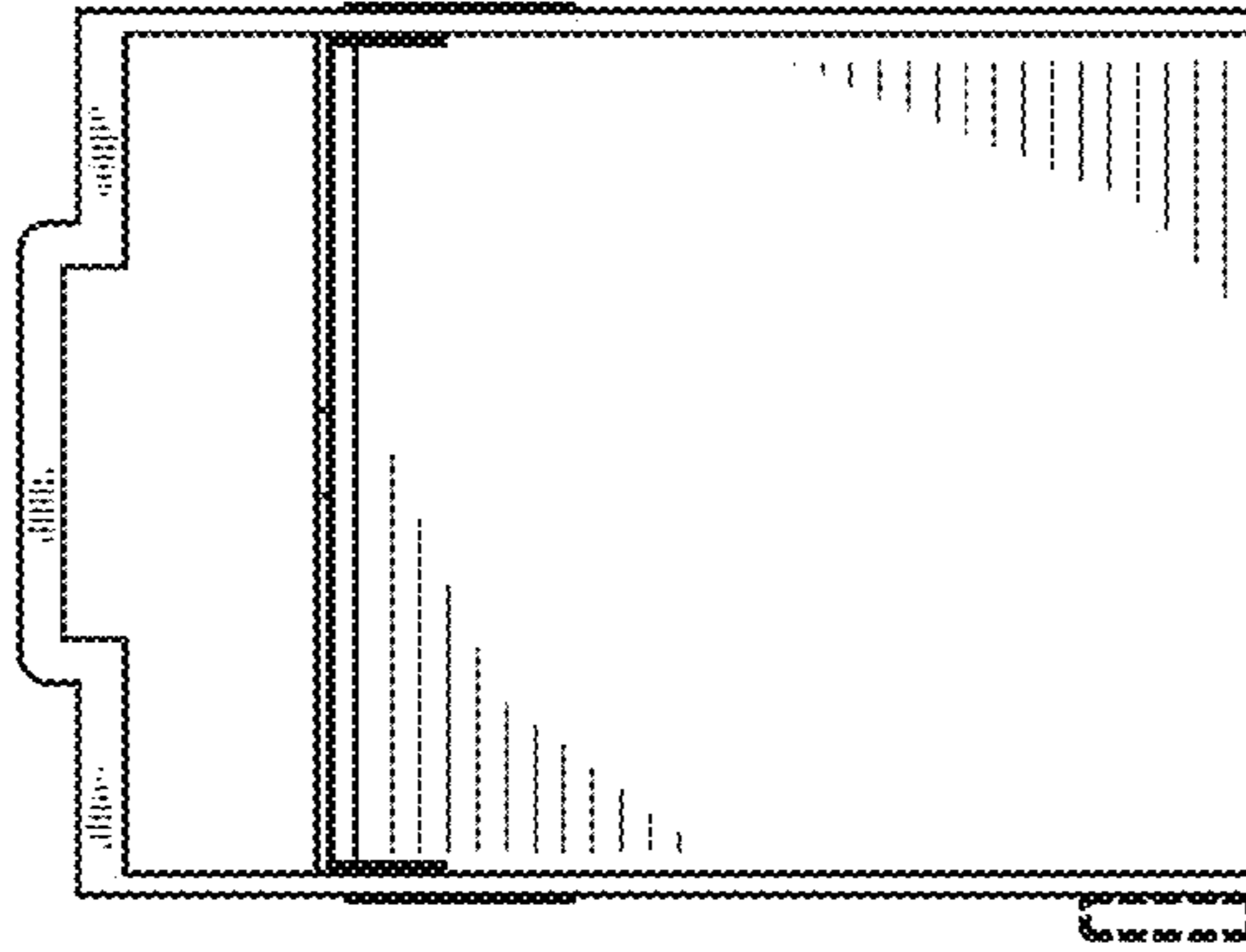

Fig. 7

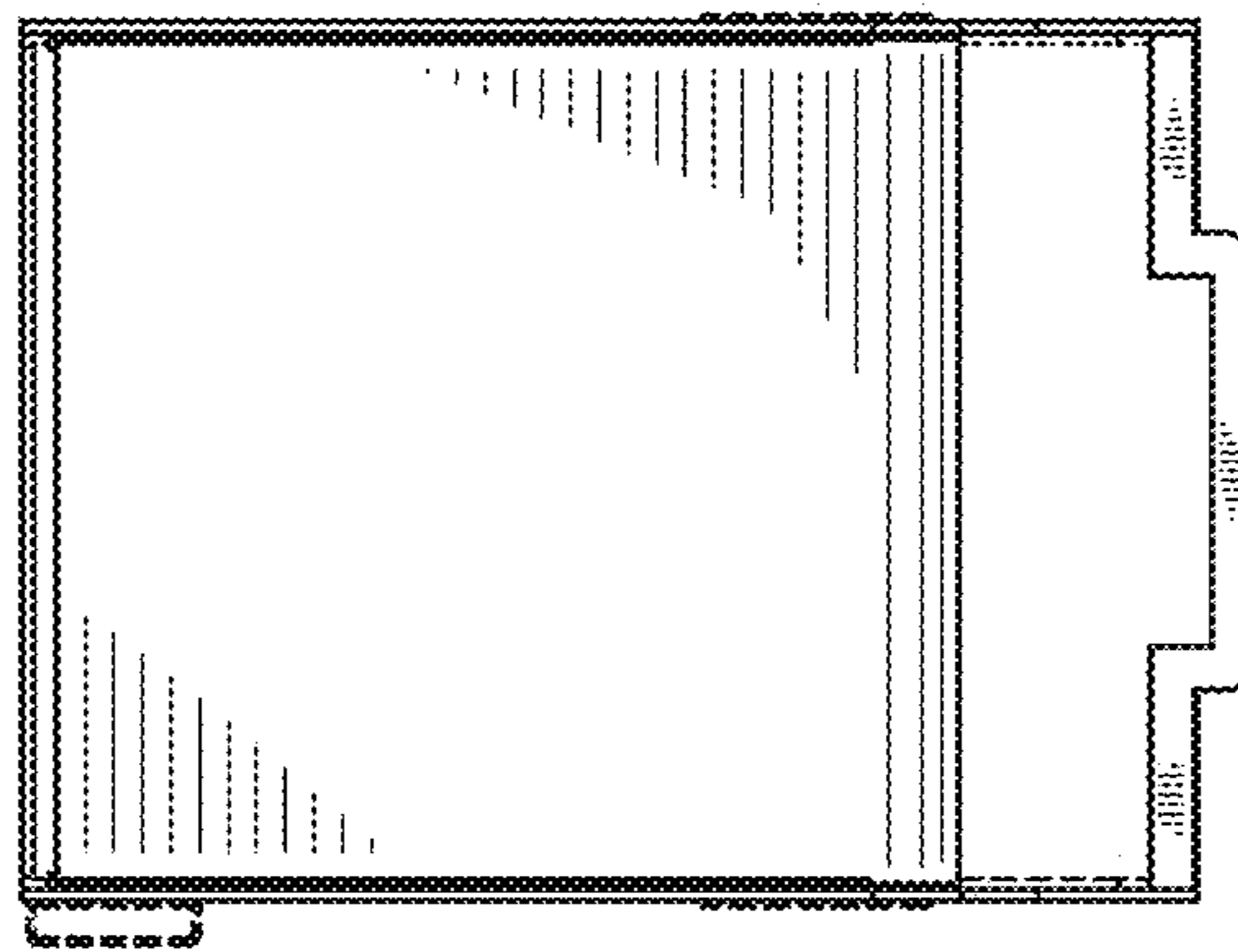

Fig. 6

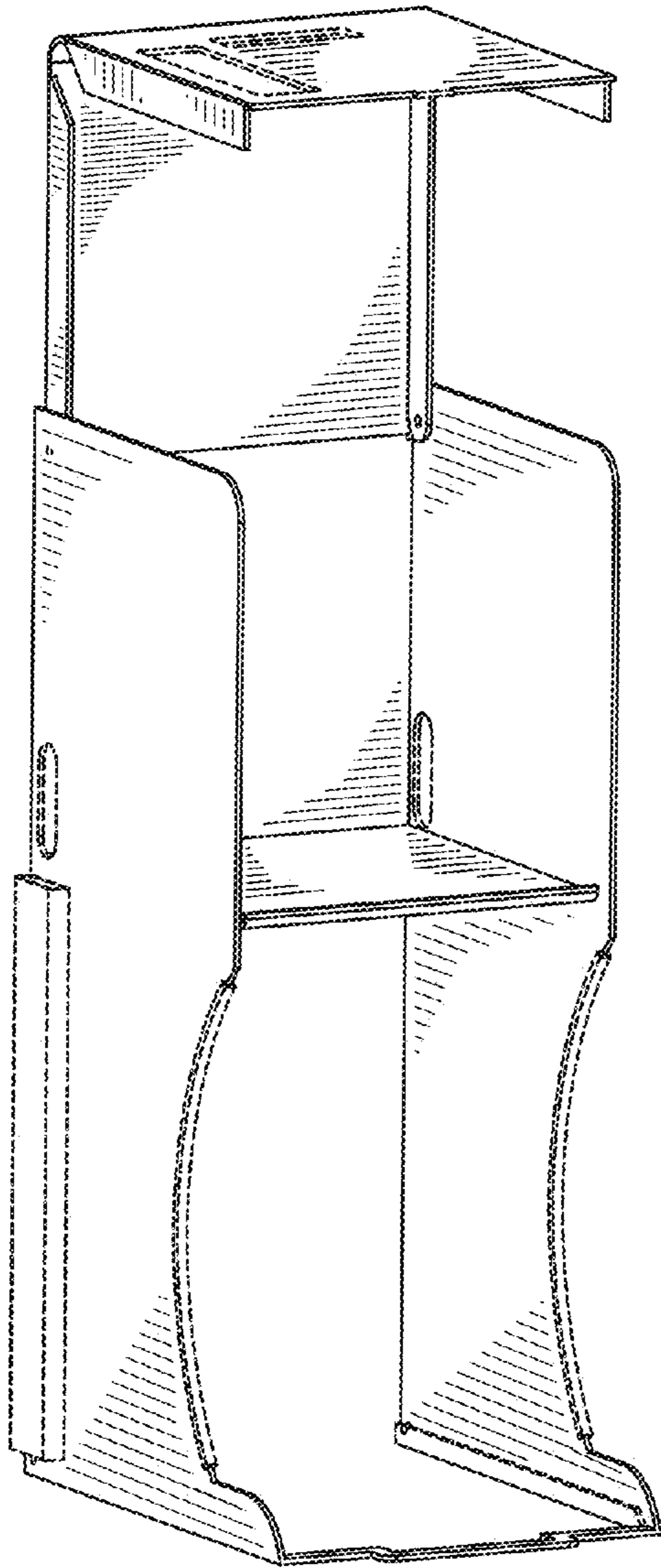

Fig. 8

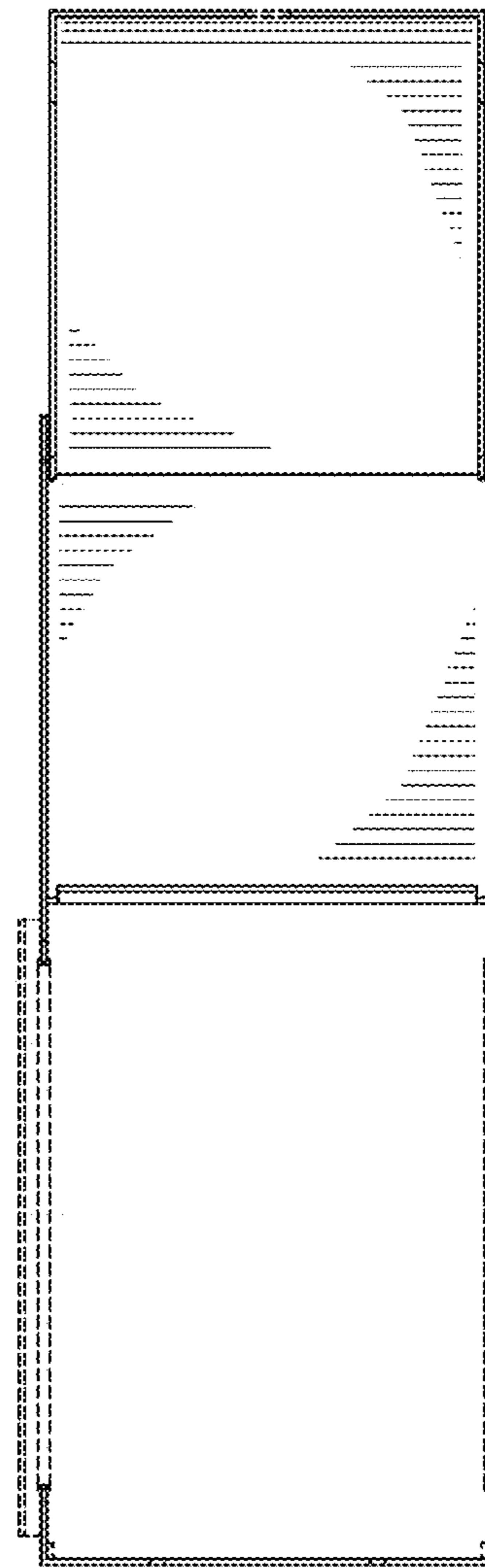

Fig. 9

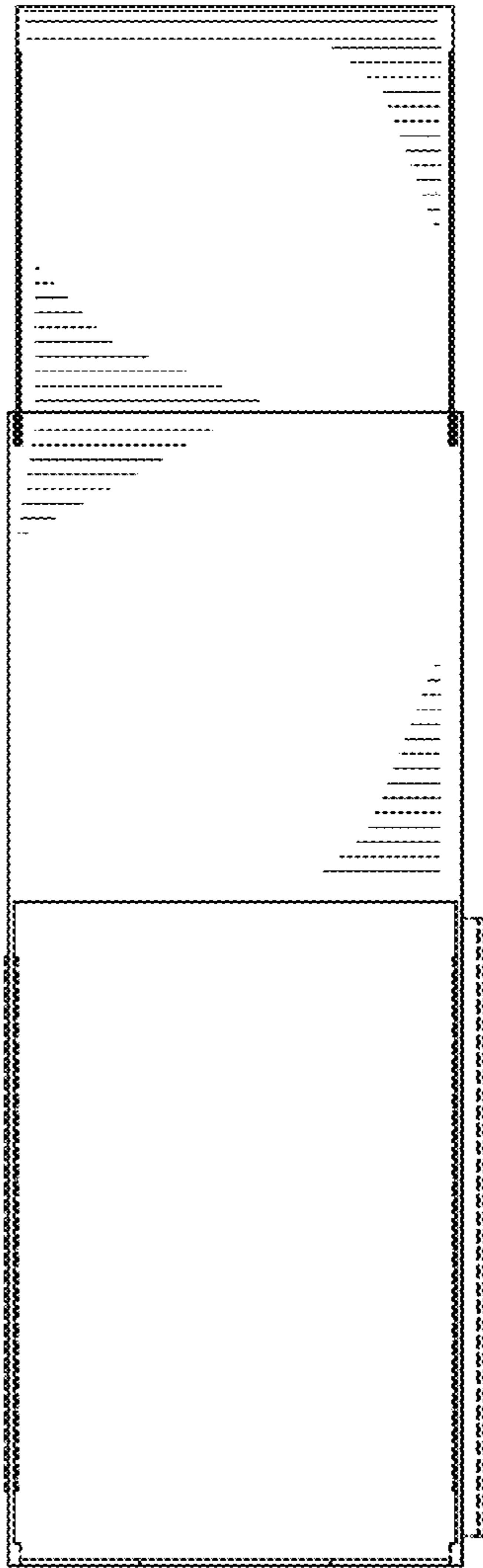

Fig. 10

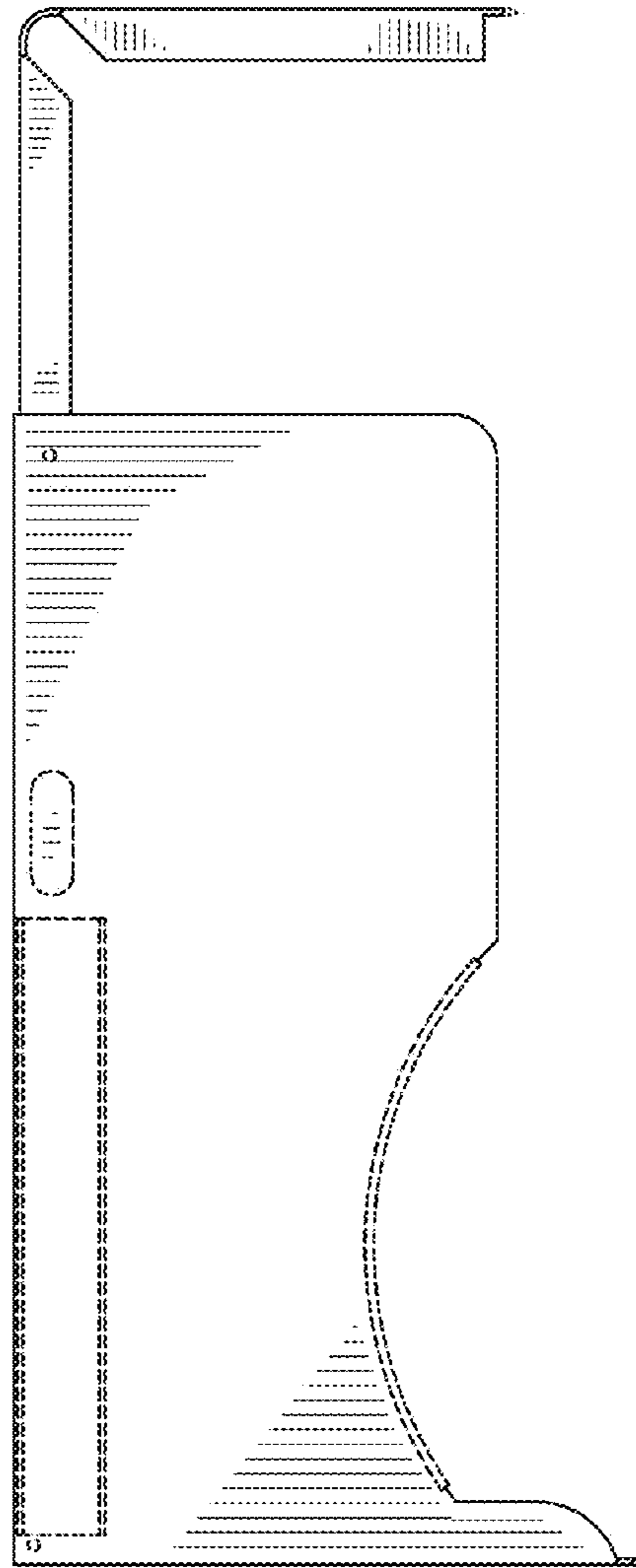

Fig. 11

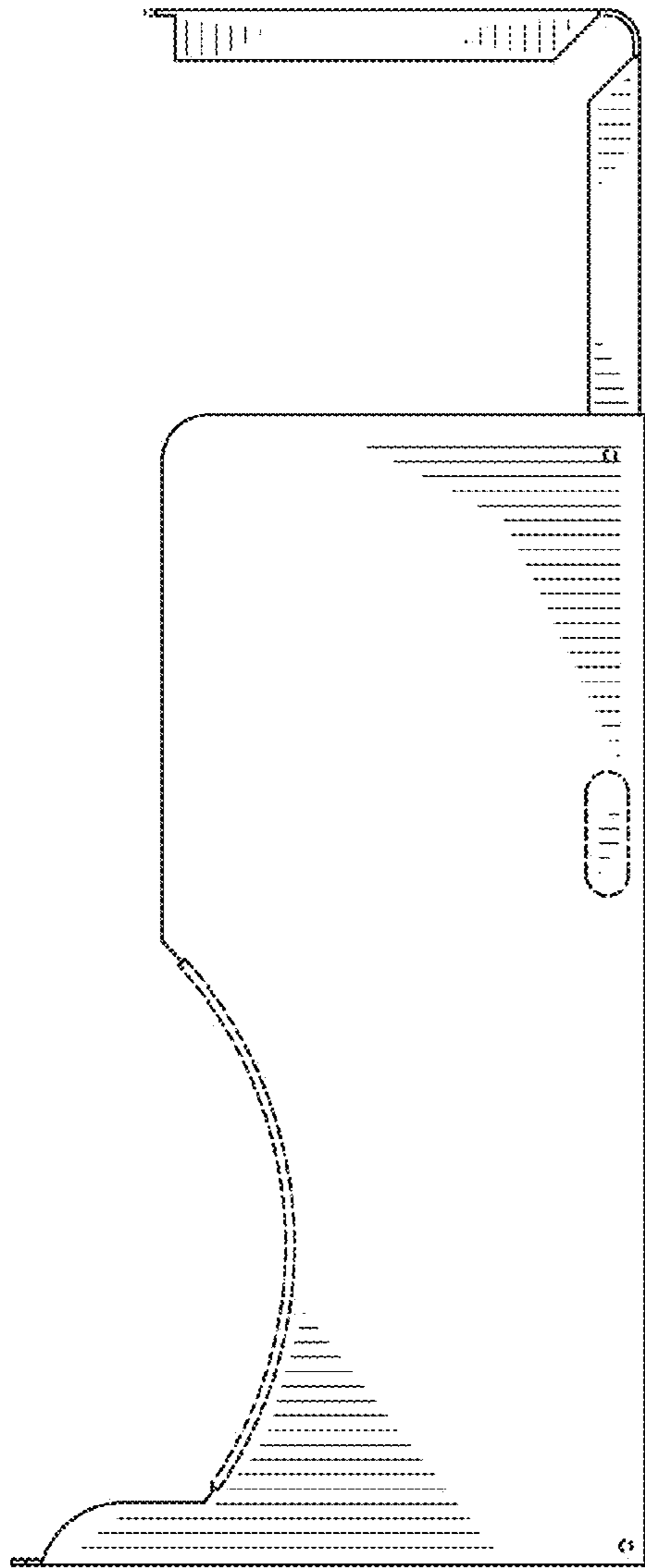

Fig. 12

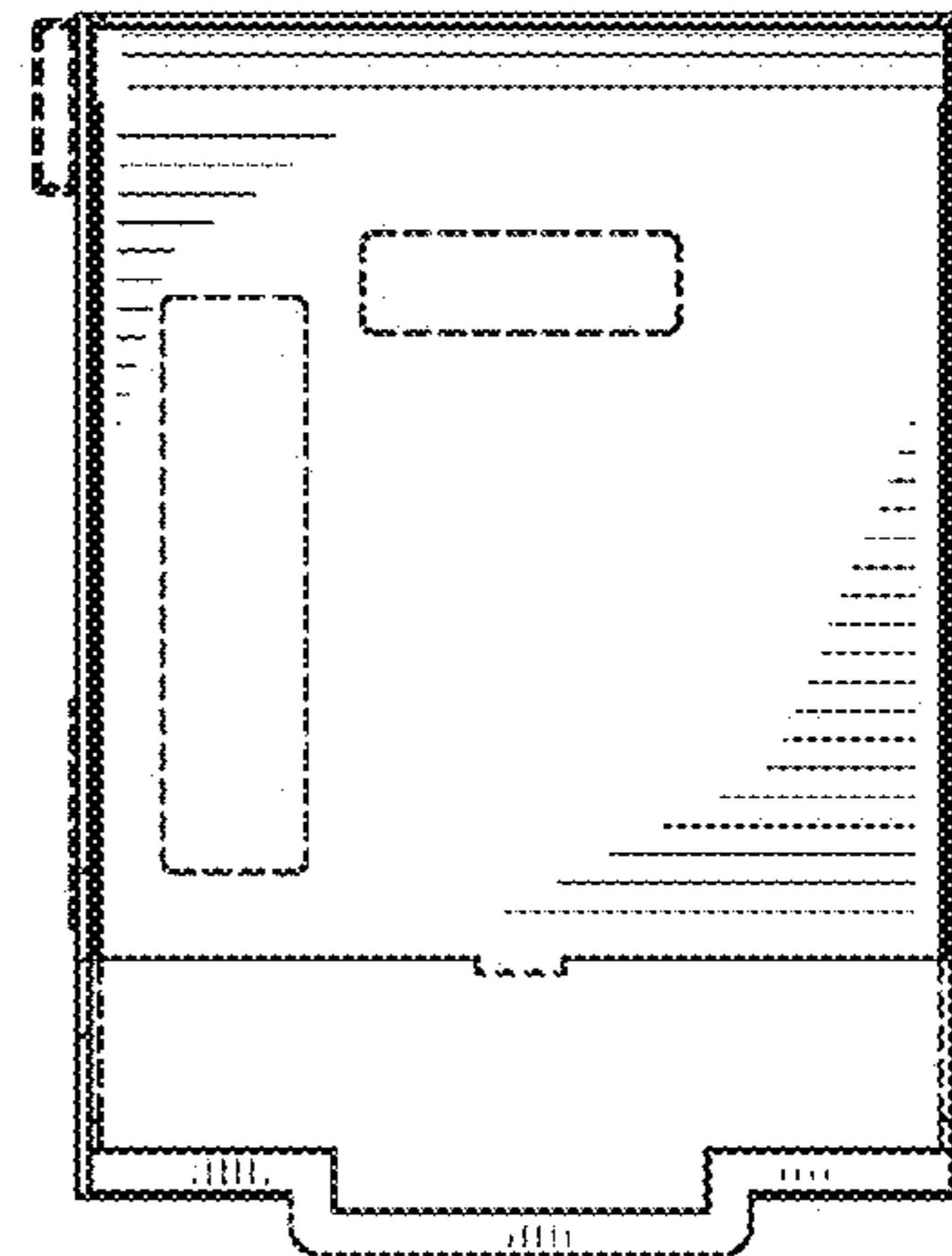

Fig. 13

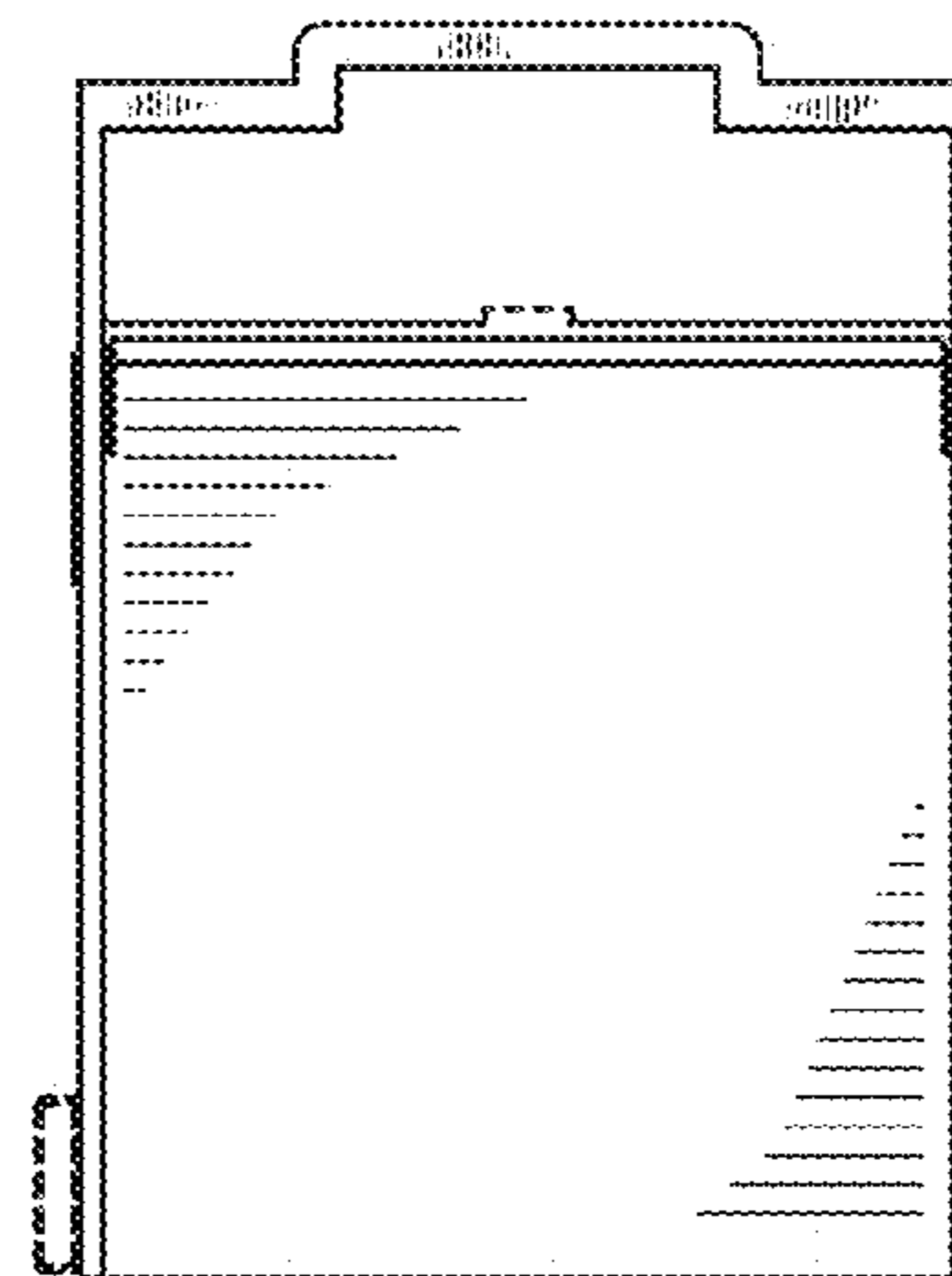

Fig. 14