



US00D752344S

(12) **United States Design Patent**  
**Green**

(10) **Patent No.:** **US D752,344 S**

(45) **Date of Patent:** **\*\* \*Mar. 29, 2016**

(54) **LUGGAGE**

(71) Applicant: **The Pukka Luggage Company Limited**, London (GB)

(72) Inventor: **Stephen Green**, Milton Keynes (GB)

(73) Assignee: **The Pukka Luggage Company Limited**, London (GB)

(\*) Notice: This patent is subject to a terminal disclaimer.

(\*\*) Term: **14 Years**

(21) Appl. No.: **29/469,246**

(22) Filed: **Oct. 8, 2013**

(30) **Foreign Application Priority Data**

Apr. 9, 2013 (EM) ..... 002217216-0001

(51) **LOC (10) Cl.** ..... **03-01**

(52) **U.S. Cl.**  
USPC ..... **D3/279; D3/272**

(58) **Field of Classification Search**  
USPC ..... D3/272, 276, 278, 279, 273, 274, 281,  
D3/289, 321, 294; 190/100-127, 903,  
190/18 A, 1, 15.1, 19-40  
CPC ..... A45C 5/00; A45C 5/005; A45C 5/03;  
A45C 2005/032-2005/037; A45C 5/04;  
A45C 5/14; A45C 5/141; A45C 2005/142;  
A45C 5/146; A45C 2005/147-2005/148  
See application file for complete search history.

(56) **References Cited**

**U.S. PATENT DOCUMENTS**

1,708,112 A \* 4/1929 Wheary ..... 190/13 R  
D351,502 S \* 10/1994 Weir et al. .... D3/272  
D378,164 S \* 2/1997 Lee ..... D3/276  
D457,724 S \* 5/2002 Och ..... D3/279

D498,361 S \* 11/2004 Badaan ..... D3/279  
6,964,420 B1 \* 11/2005 Ghanizadeh et al. .... 280/47.131  
D625,517 S \* 10/2010 Rossi et al. .... D3/272  
D644,435 S \* 9/2011 Weng ..... D3/279  
2004/0188205 A1 \* 9/2004 Badaan ..... 190/124  
2011/0284334 A1 \* 11/2011 Cheng ..... 190/18 A

**OTHER PUBLICATIONS**

Pukka Trunk, Pukka Booklet at [http://pukkaluggage.com/Pukka\\_Booklet.pdf](http://pukkaluggage.com/Pukka_Booklet.pdf), p. 7 (1909).

\* cited by examiner

*Primary Examiner* — Jennifer Rivard

(74) *Attorney, Agent, or Firm* — Dickstein Shapiro LLP

(57) **CLAIM**

The ornamental design for luggage, as shown and described.

**DESCRIPTION**

FIG. 1 is a front side view of the luggage with the handle and wheels retracted.

FIG. 2 is a back side thereof, with the handle and wheels retracted.

FIG. 3 is a left side view thereof, with the handle and wheels retracted.

FIG. 4 is a right side view thereof, with the handle and wheels retracted.

FIG. 5 is a top view thereof, with the handle and wheels retracted.

FIG. 6 is a bottom view thereof, with the handle and wheels retracted.

FIG. 7 is a perspective view thereof, with the handle and wheels retracted; and,

FIG. 8 is a perspective view thereof, with the handle and wheels extended.

The word PUKKA appearing in the drawings and forming part of the claimed design is a registered trademark of The Pukka Luggage Company Limited, London, UK.

**1 Claim, 8 Drawing Sheets**

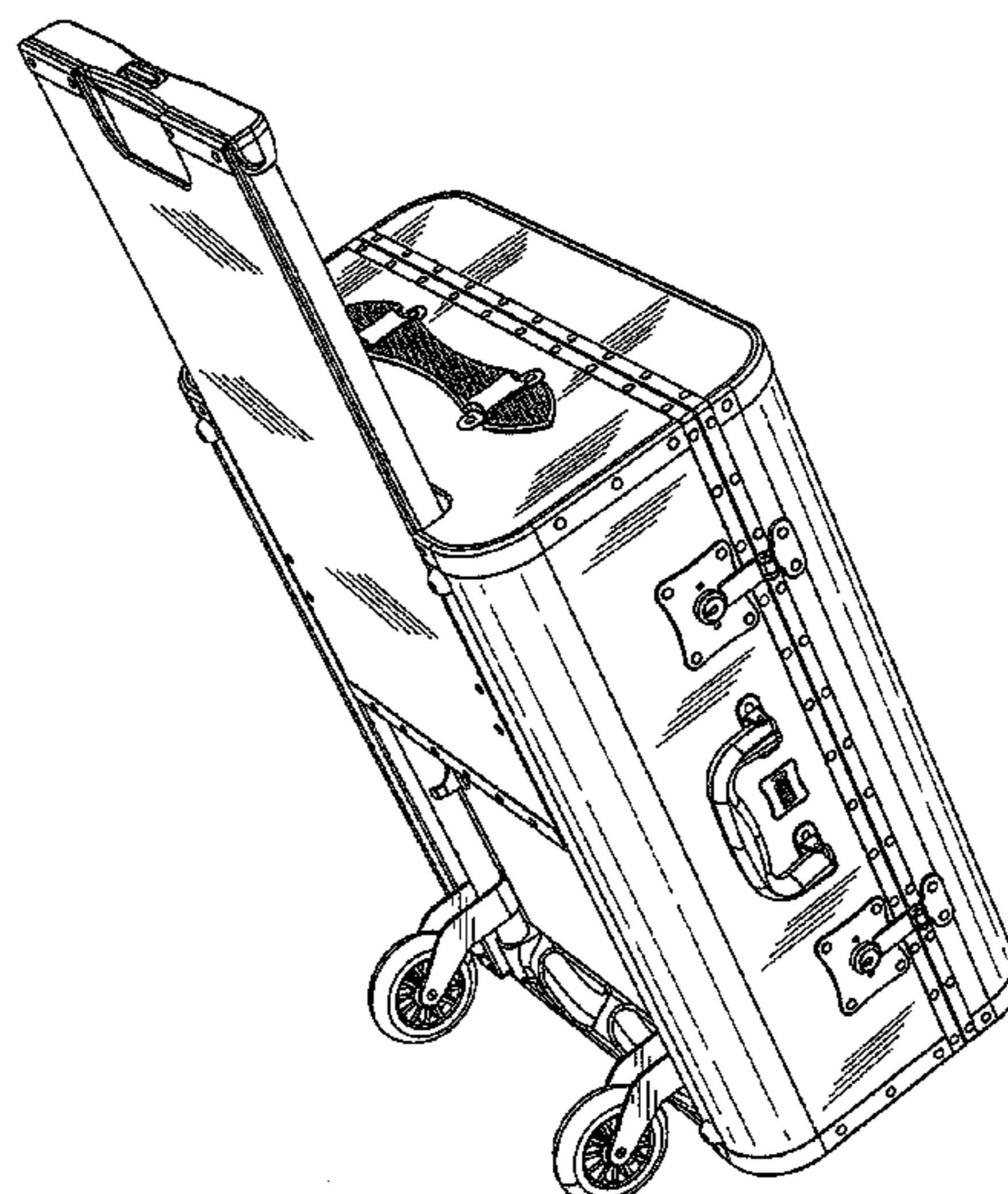

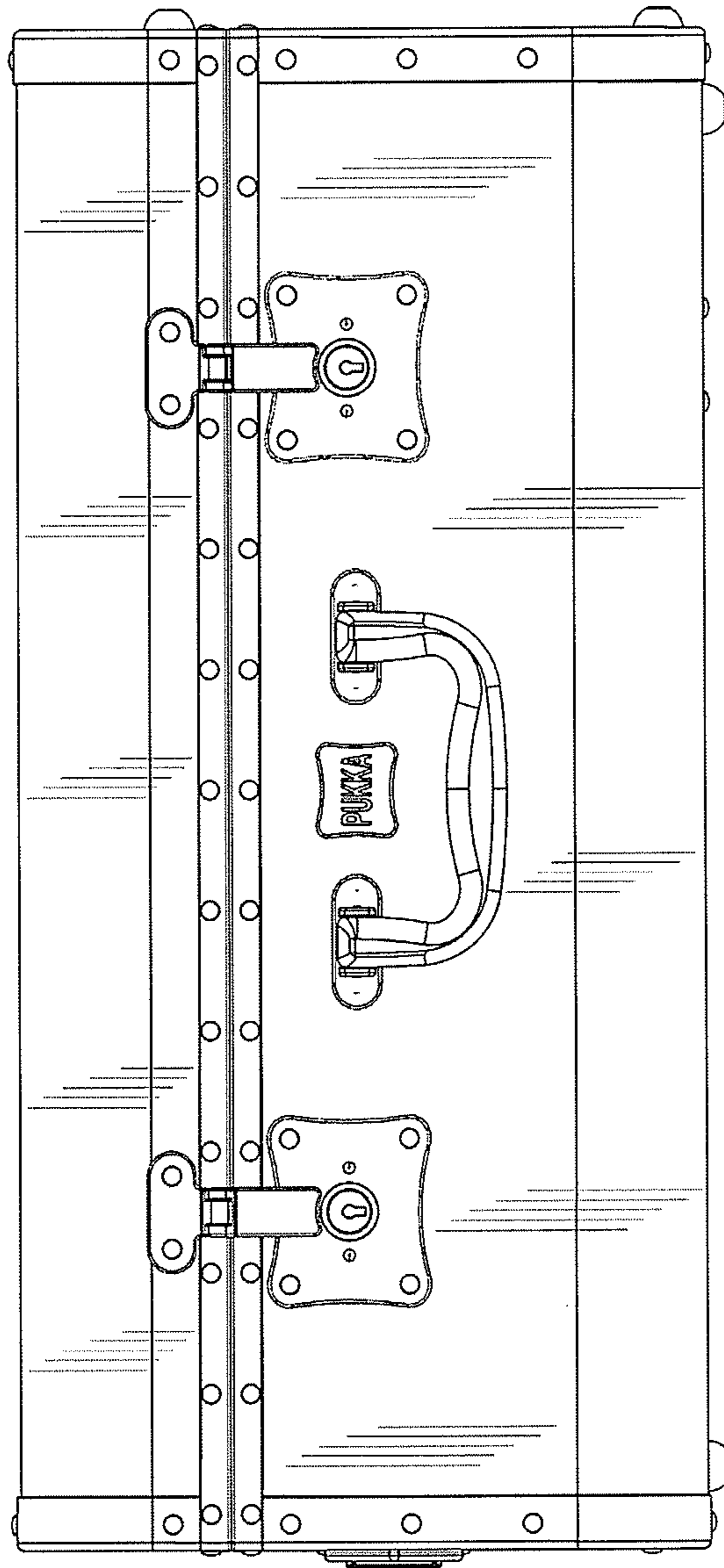

FIG. 1

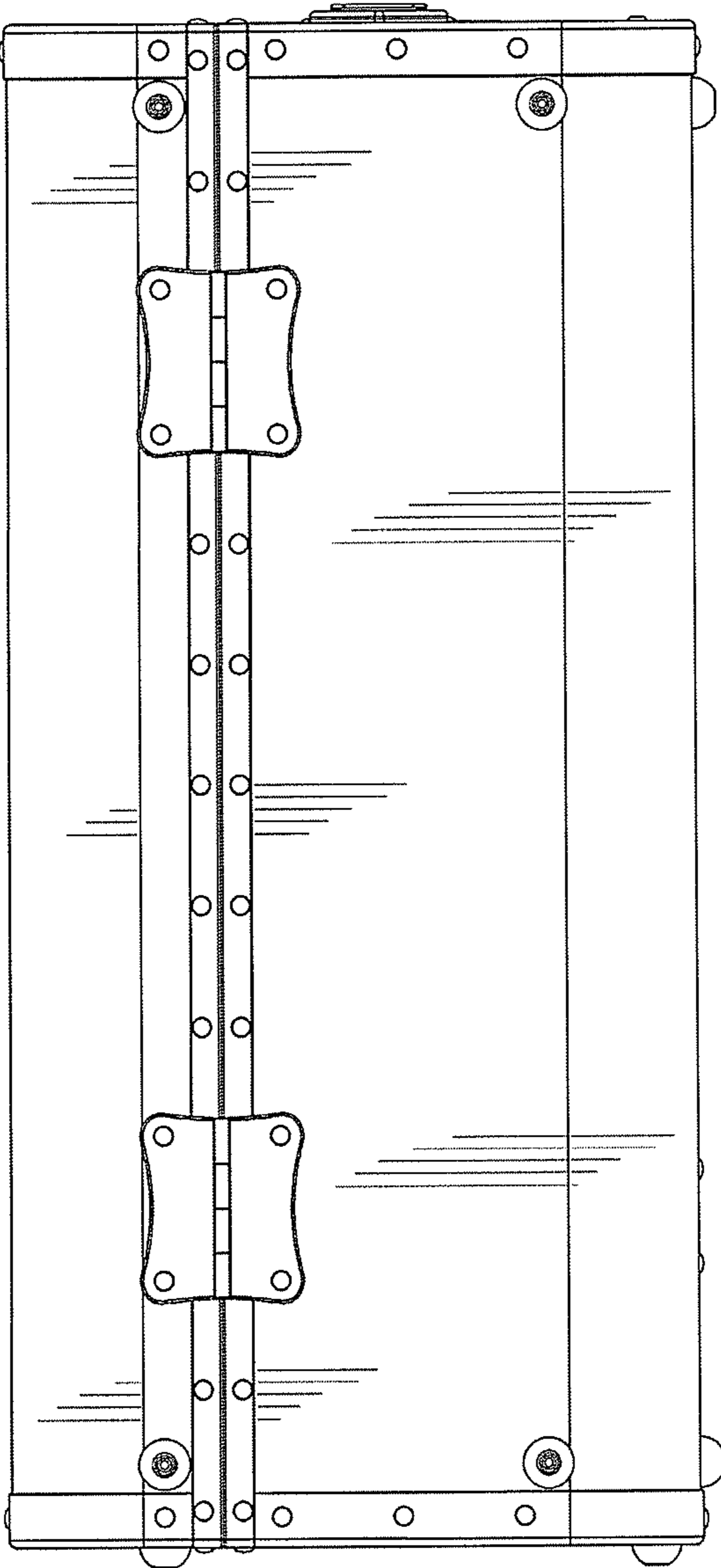

FIG. 2

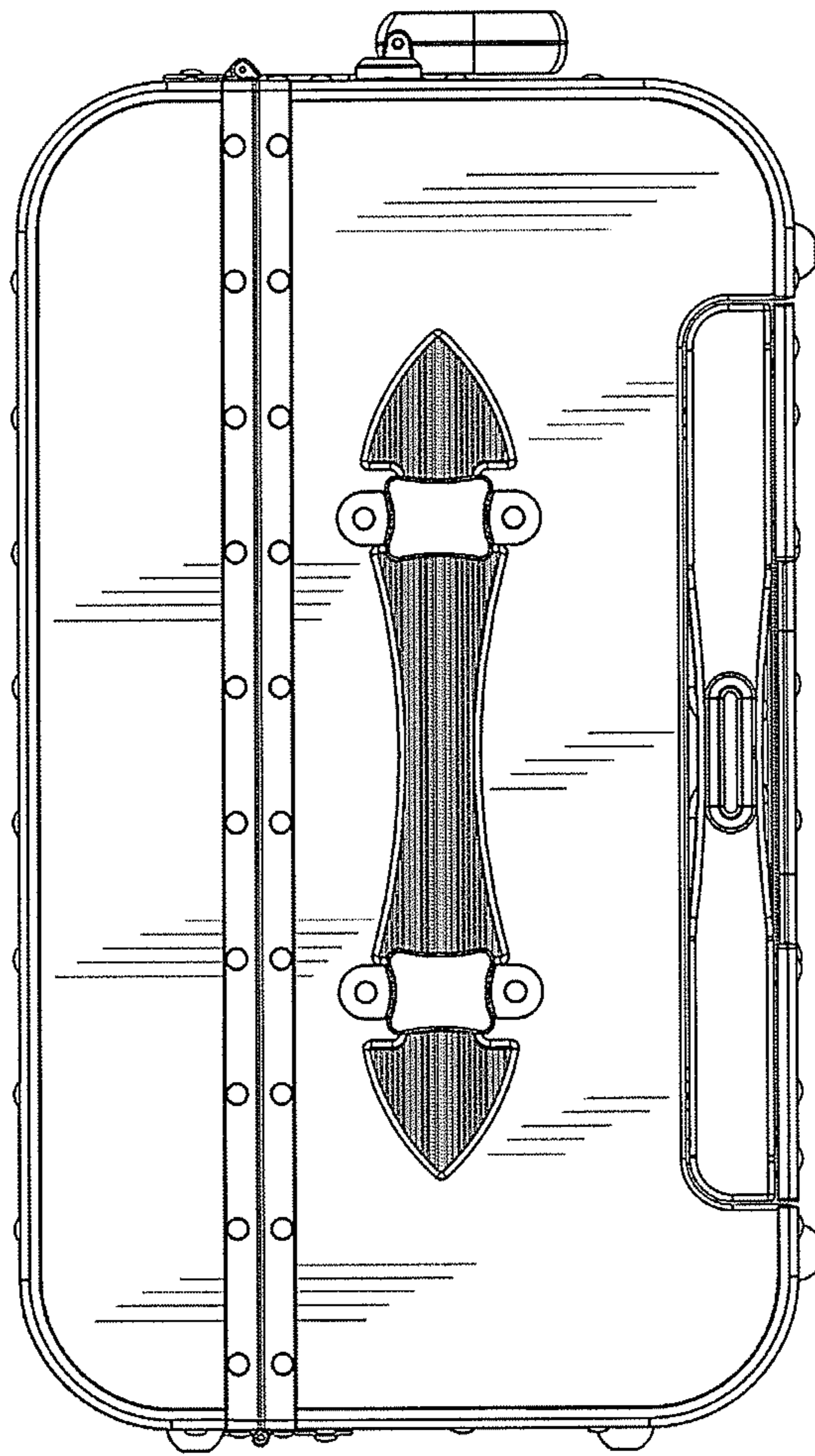

FIG. 3

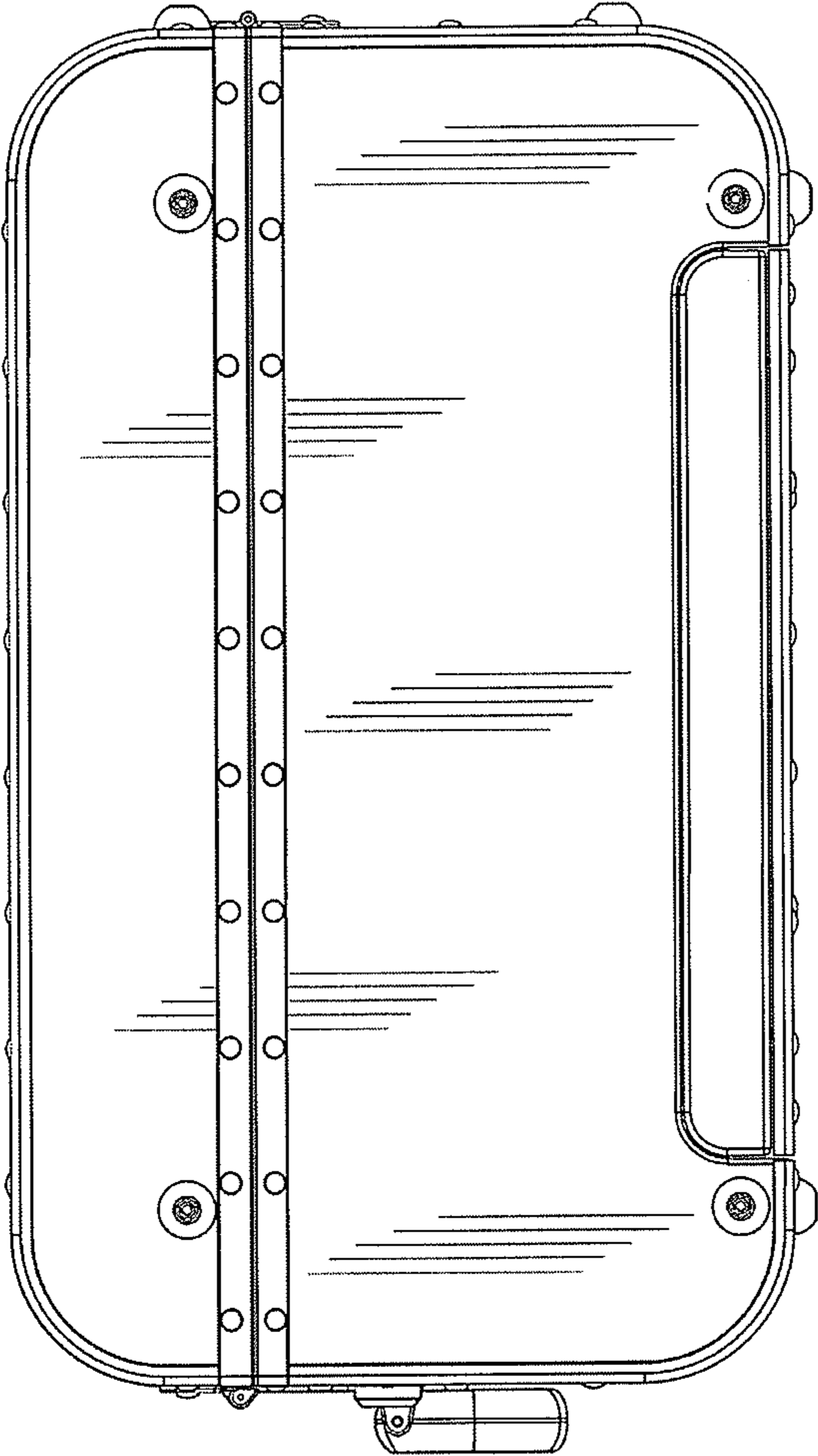

FIG. 4

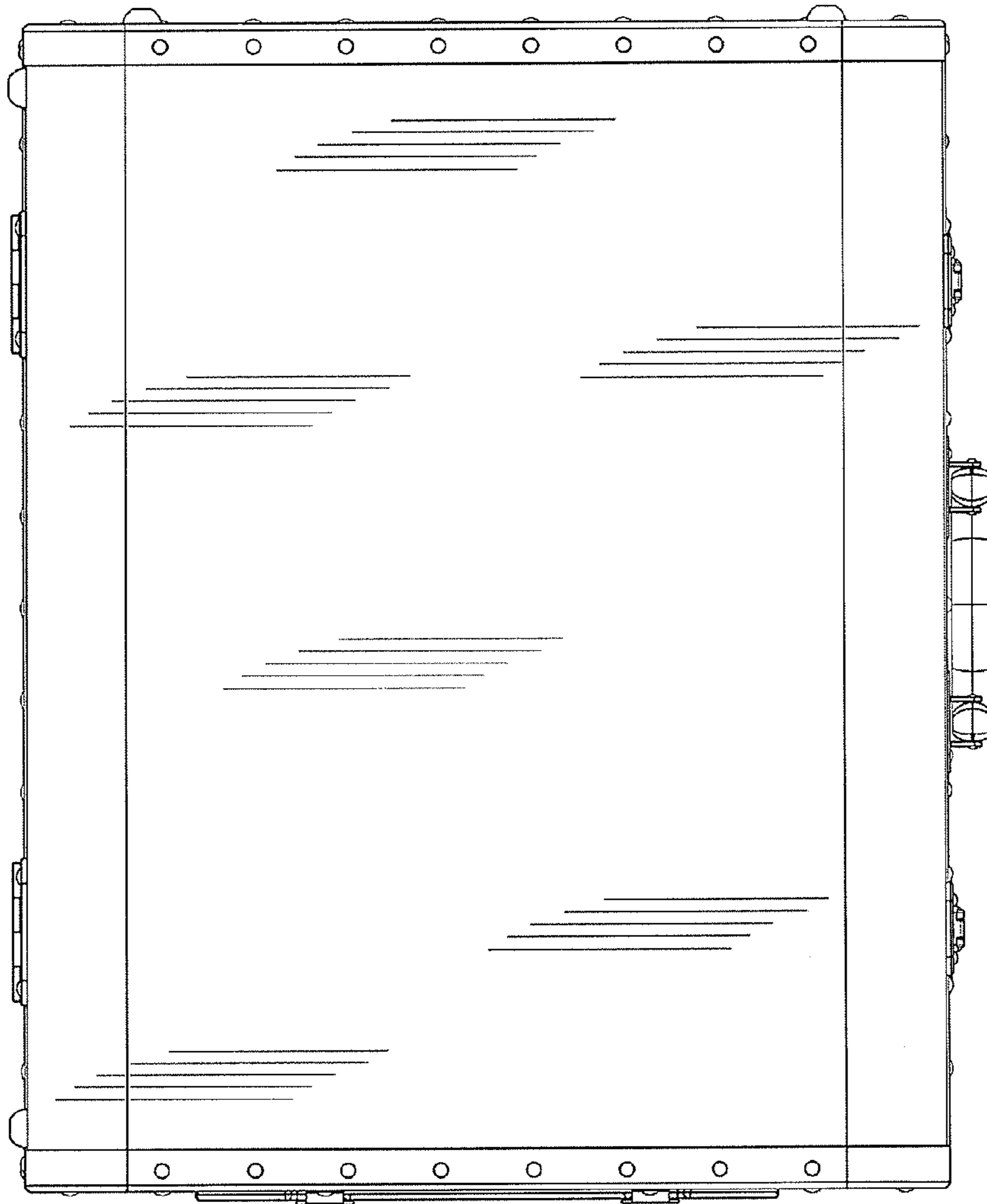

FIG. 5

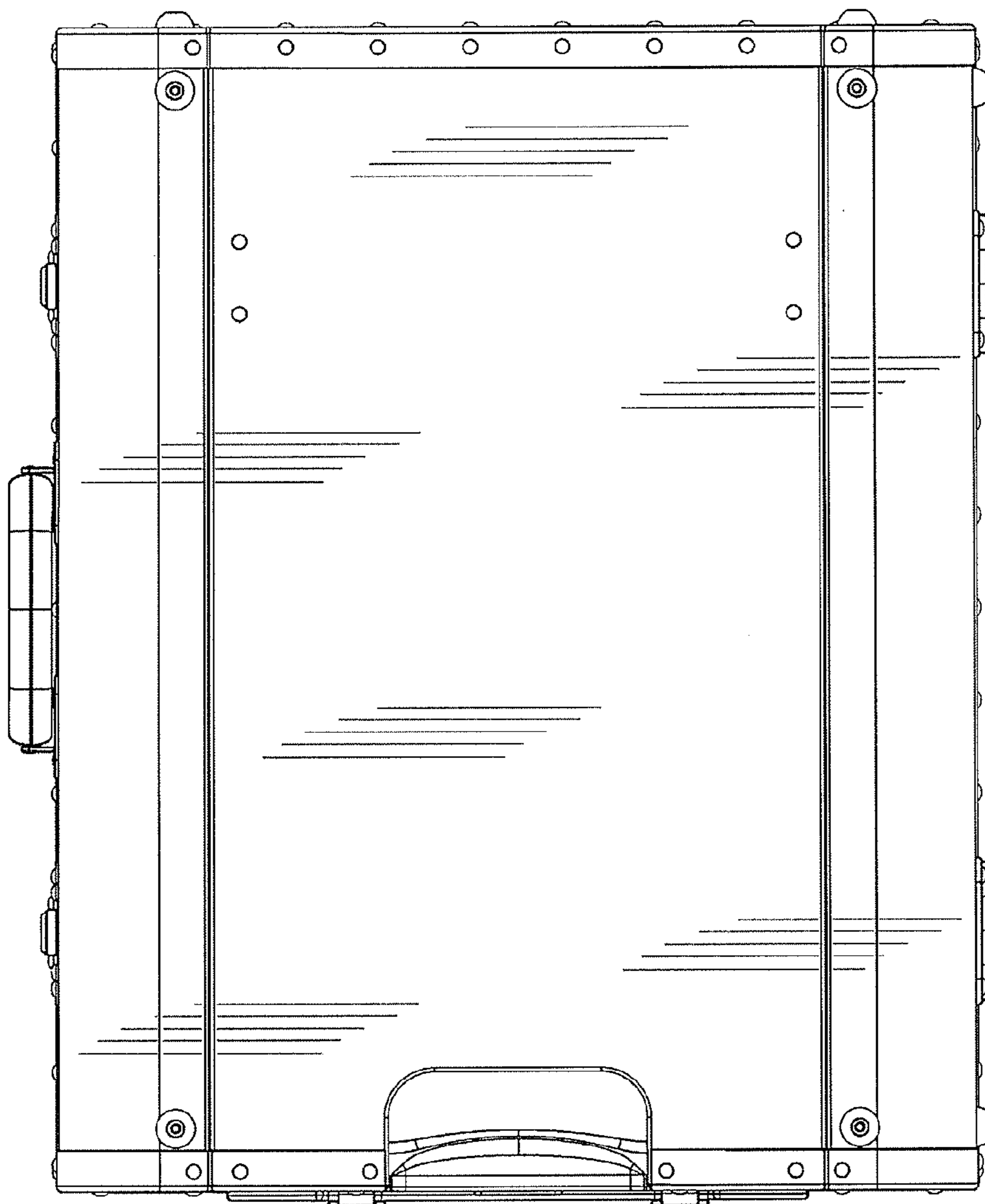

FIG. 6

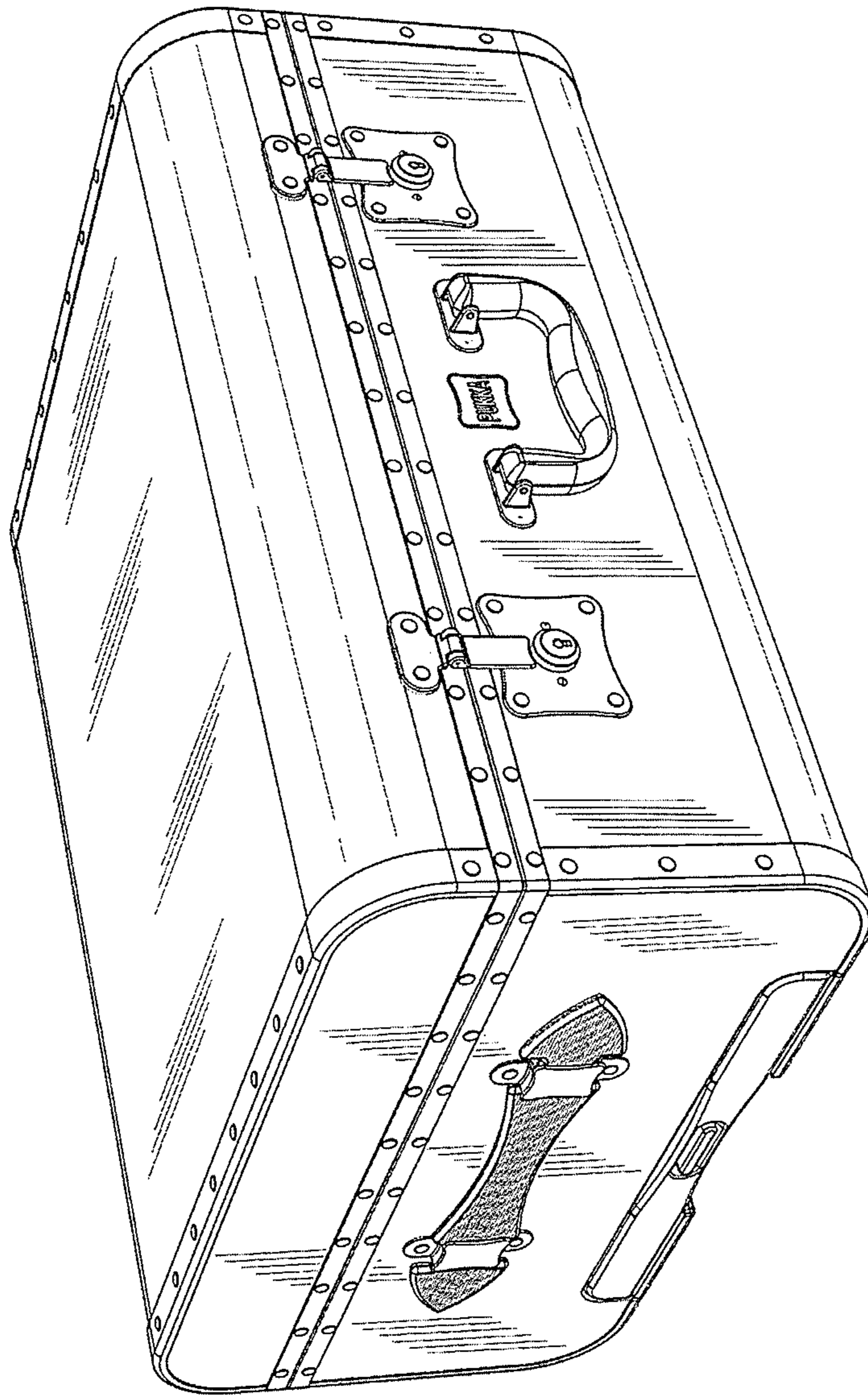

FIG. 7



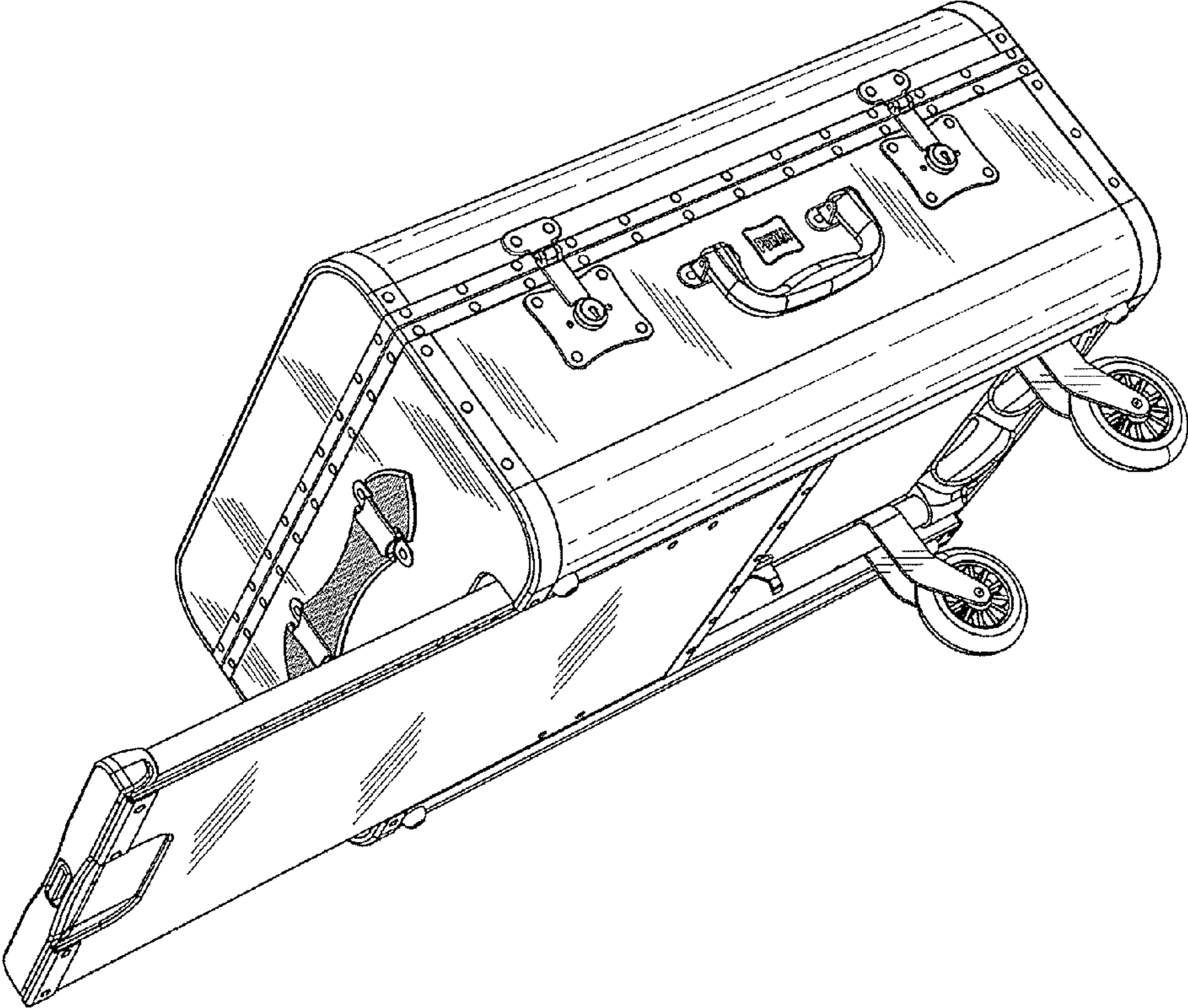

FIG. 8