



US00D752289S

(12) **United States Design Patent**
Tegtmeyer

(10) **Patent No.:** **US D752,289 S**
(45) **Date of Patent:** **** Mar. 22, 2016**

(54) **COLOR ORGANIZER**

(71) Applicant: **Muriel Tegtmeyer**, Carol Stream, IL
(US)

(72) Inventor: **Muriel Tegtmeyer**, Carol Stream, IL
(US)

(**) Term: **14 Years**

(21) Appl. No.: **29/493,916**

(22) Filed: **Jun. 16, 2014**

(51) **LOC (10) Cl.** **28-03**

(52) **U.S. Cl.**
USPC **D28/56; D3/2**

(58) **Field of Classification Search**
USPC 434/98, 100, 101, 104; D28/56, 57, 9,
D28/61, 73; 132/200; 40/492; D19/64;
D3/1-4
CPC G09F 5/042; A45D 44/005; G01J 3/52
See application file for complete search history.

(56) **References Cited**

U.S. PATENT DOCUMENTS

3,434,227	A *	3/1969	Brown, Jr.	G01J 3/52 281/15.1
4,104,809	A *	8/1978	Day	G09F 5/04 281/15.1
4,253,259	A *	3/1981	Schaffer	G09F 5/04 281/15.1
5,174,758	A *	12/1992	Abramson	G01J 3/52 434/104
5,398,704	A *	3/1995	Dombeck	A45D 29/22 132/285
D357,280	S *	4/1995	Bechler	D19/64
5,645,090	A	7/1997	Juhl	
5,778,901	A	7/1998	Abrahamian	
5,909,811	A	6/1999	Harris	
6,665,965	B1 *	12/2003	Turchi	G09F 5/04 356/422
6,913,144	B1 *	7/2005	Todd	G09F 5/00 206/388
7,822,504	B2	10/2010	Bartholomew	

7,938,127 B1 5/2011 Maxwell
D648,392 S * 11/2011 Thorpe D19/64
8,276,599 B2 10/2012 Gindi
8,352,070 B2 1/2013 Bartholomew

(Continued)

OTHER PUBLICATIONS

Amazon.com Fashion Base 50 Tips Clear Fan-shaped Nail Art Display Chart. Nail Polish Samples.

Primary Examiner — Jennifer Rivard

(74) *Attorney, Agent, or Firm* — Michael P. Mazza, LLC

(57) **CLAIM**

I claim the ornamental design for the color organizer, as shown and described in the drawings.

DESCRIPTION

FIG. 1 is a front and top perspective view of one preferred embodiment of the color organizer of the present invention, shown in an open (unfolded or fanned-open) position; FIG. 2 is a top plan view of the color organizer shown in FIG. 1; FIG. 3 is a front elevation view of the color organizer shown in FIG. 1; FIG. 4 is a left-side elevation view of the color organizer of FIG. 1; FIG. 5 is a right-side elevation view of the color organizer shown in FIG. 1; FIG. 6 is a bottom plan view of the color organizer shown in FIG. 1; FIG. 7 is a rear elevation view of the color organizer shown in FIG. 1; FIG. 8 is a perspective view of the color organizer of FIG. 1, shown in a closed (folded or fanned-closed) position; and, FIG. 9 is a left side elevation view of the color organizer shown in FIG. 8.

The ornamental design for a color organizer (such as to organize colors for nail polish or thread) as shown and described in the drawings.

1 Claim, 4 Drawing Sheets

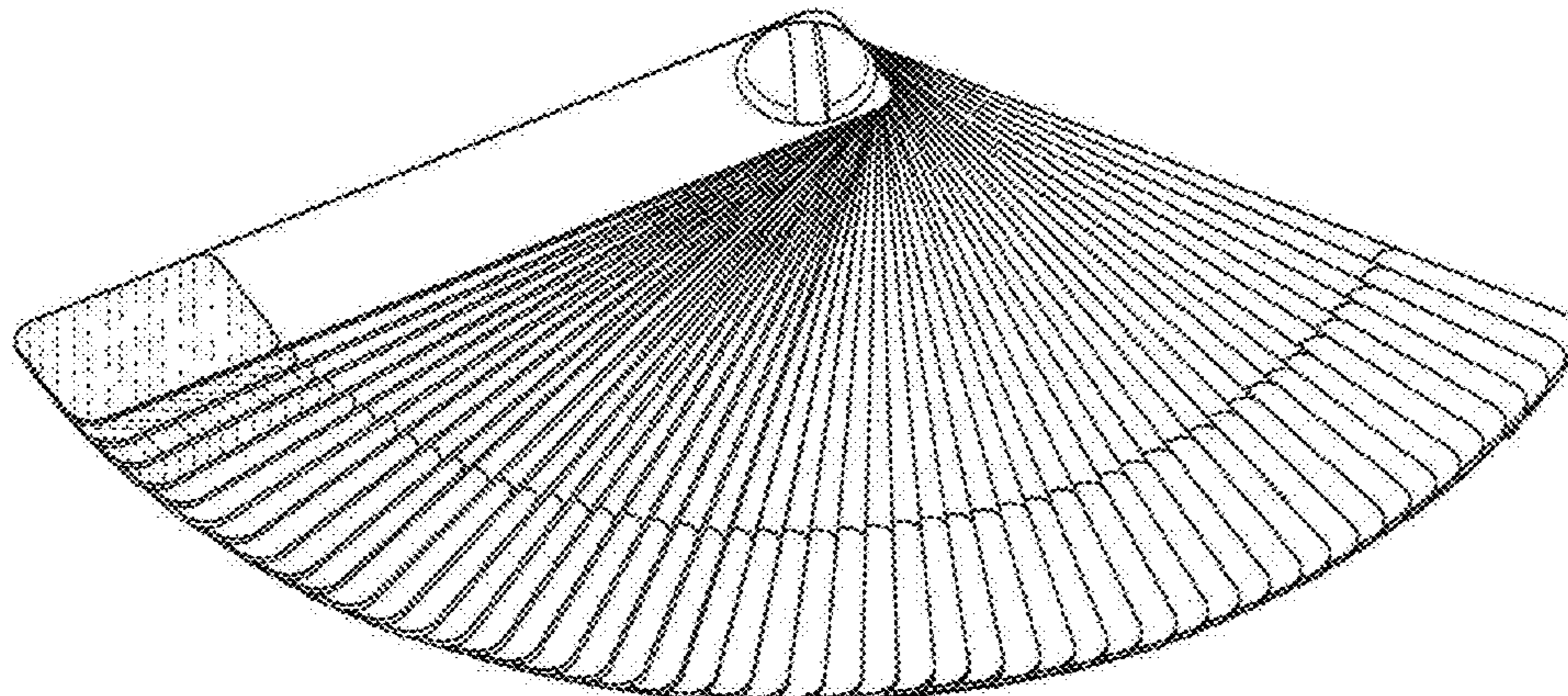

(56)

References Cited

U.S. PATENT DOCUMENTS

RE44,113 E *	4/2013	Winter	B44D 3/003	156/182	2005/0160641 A1*	7/2005	Camacho	G09F 5/04	40/492
8,602,039 B1	12/2013	Gindi				2008/0079256 A1*	4/2008	Cantarella	G09F 5/042	283/56
8,616,886 B2 *	12/2013	Clark	A45D 29/00	434/100	2009/0235946 A1*	9/2009	Kalla	A45D 44/005	132/200
2004/0181981 A1*	9/2004	DaRif	G09F 5/04	40/124.01	2012/0009548 A1*	1/2012	Feit	G09F 5/042	434/95
2005/0155943 A1*	7/2005	Butcher	A47F 7/163	211/45	2012/0021387 A1*	1/2012	Watanabe	B44D 3/04	434/98
						2014/0045149 A1*	2/2014	Winter	G09F 5/042	434/98

* cited by examiner

Fig. 1

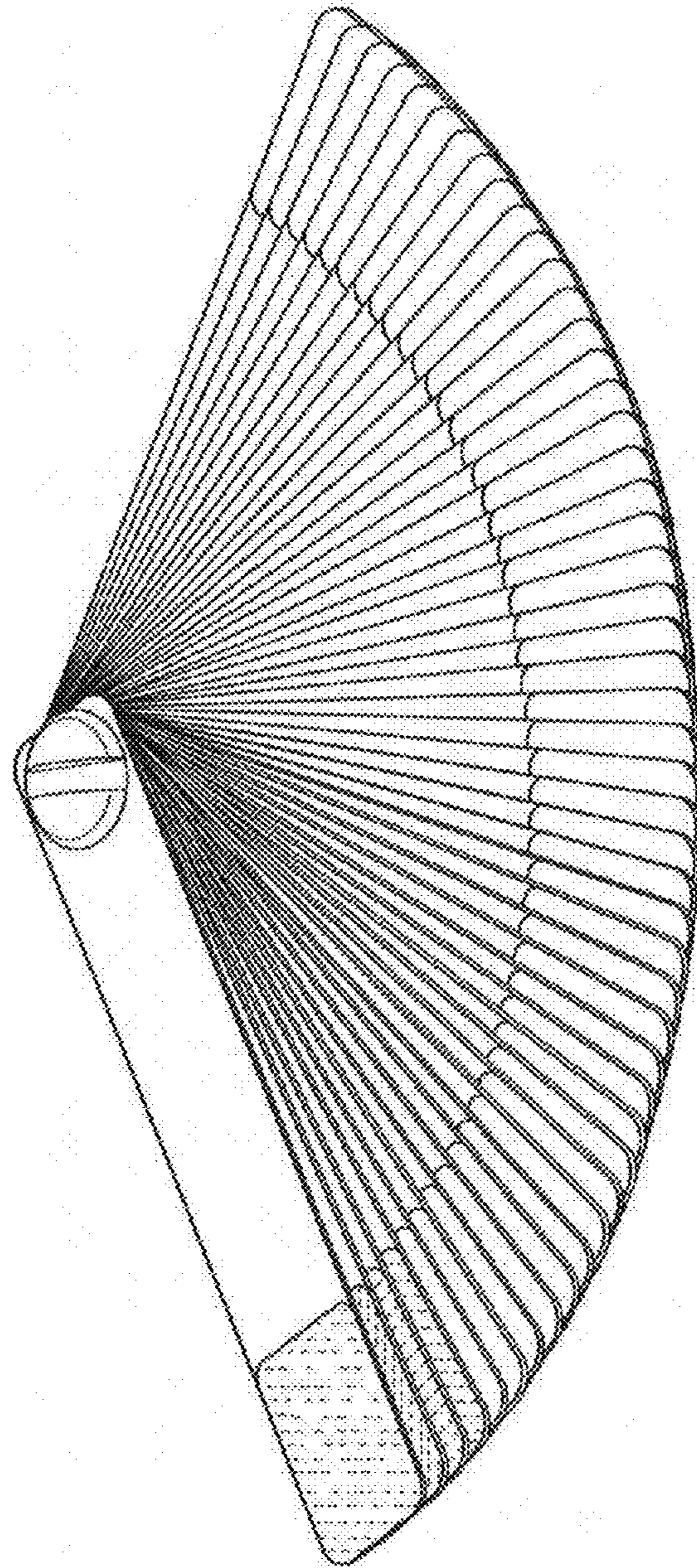

Fig. 5

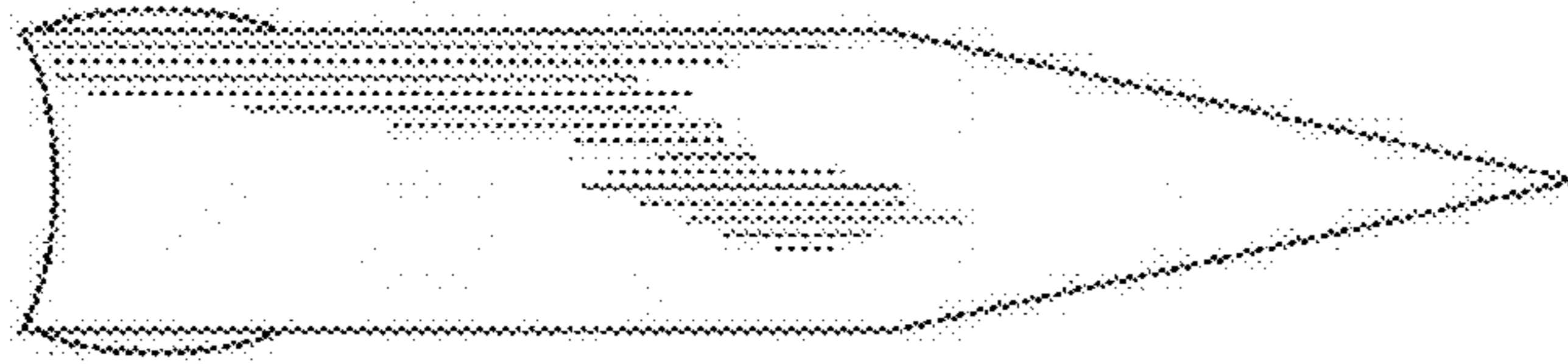

Fig. 2

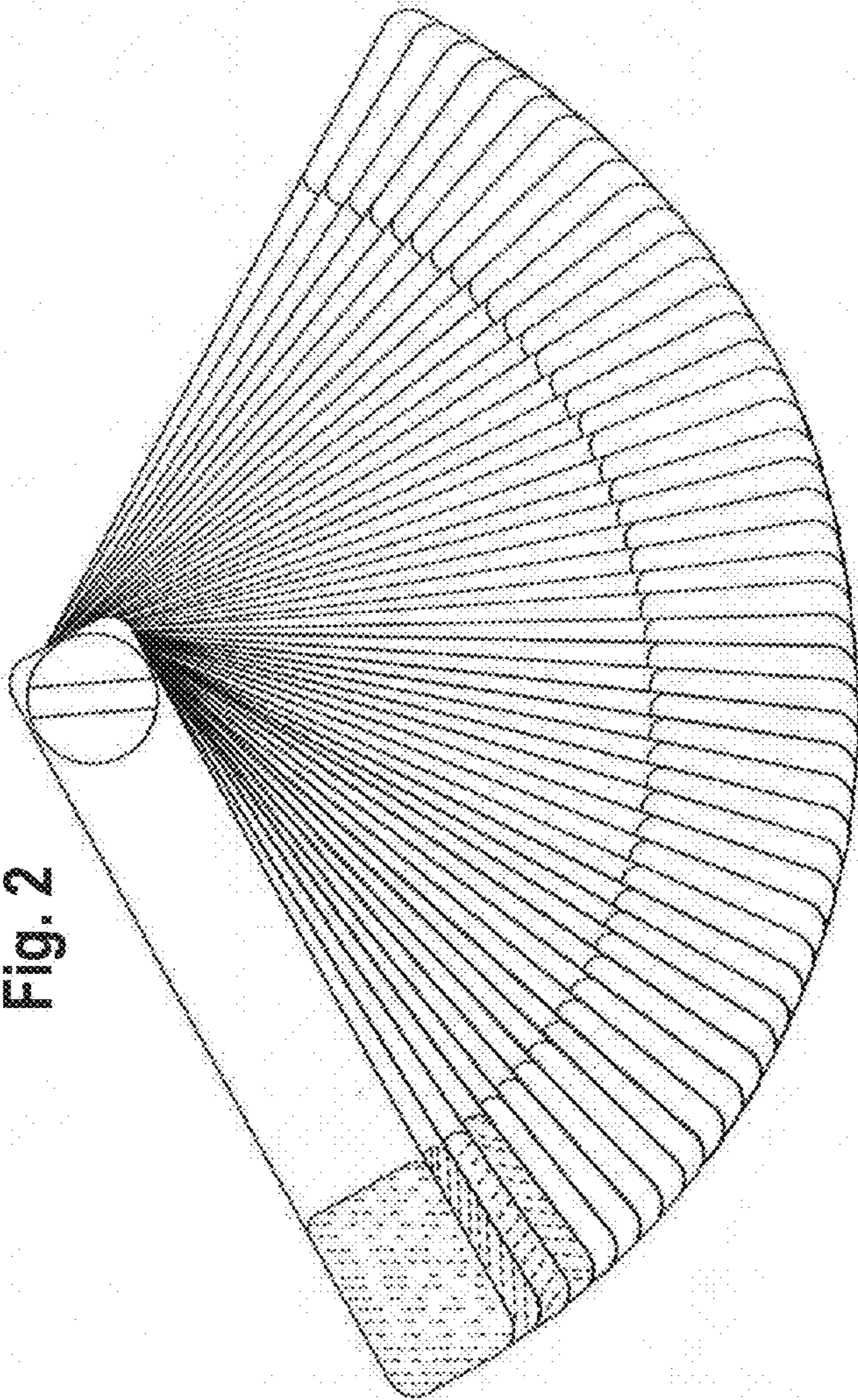

Fig. 4

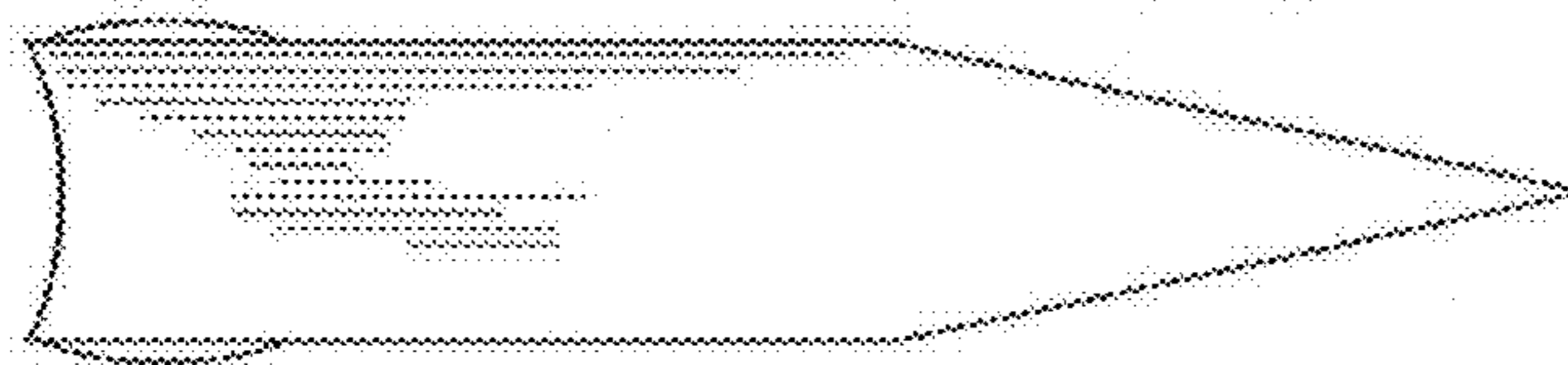
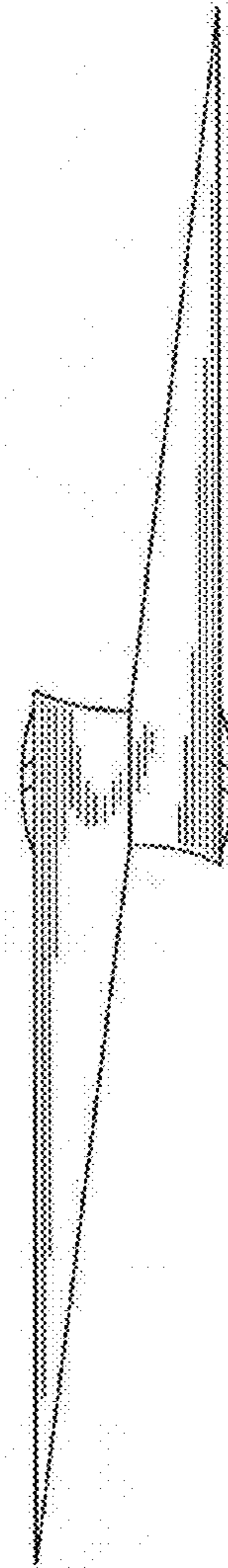

Fig. 3



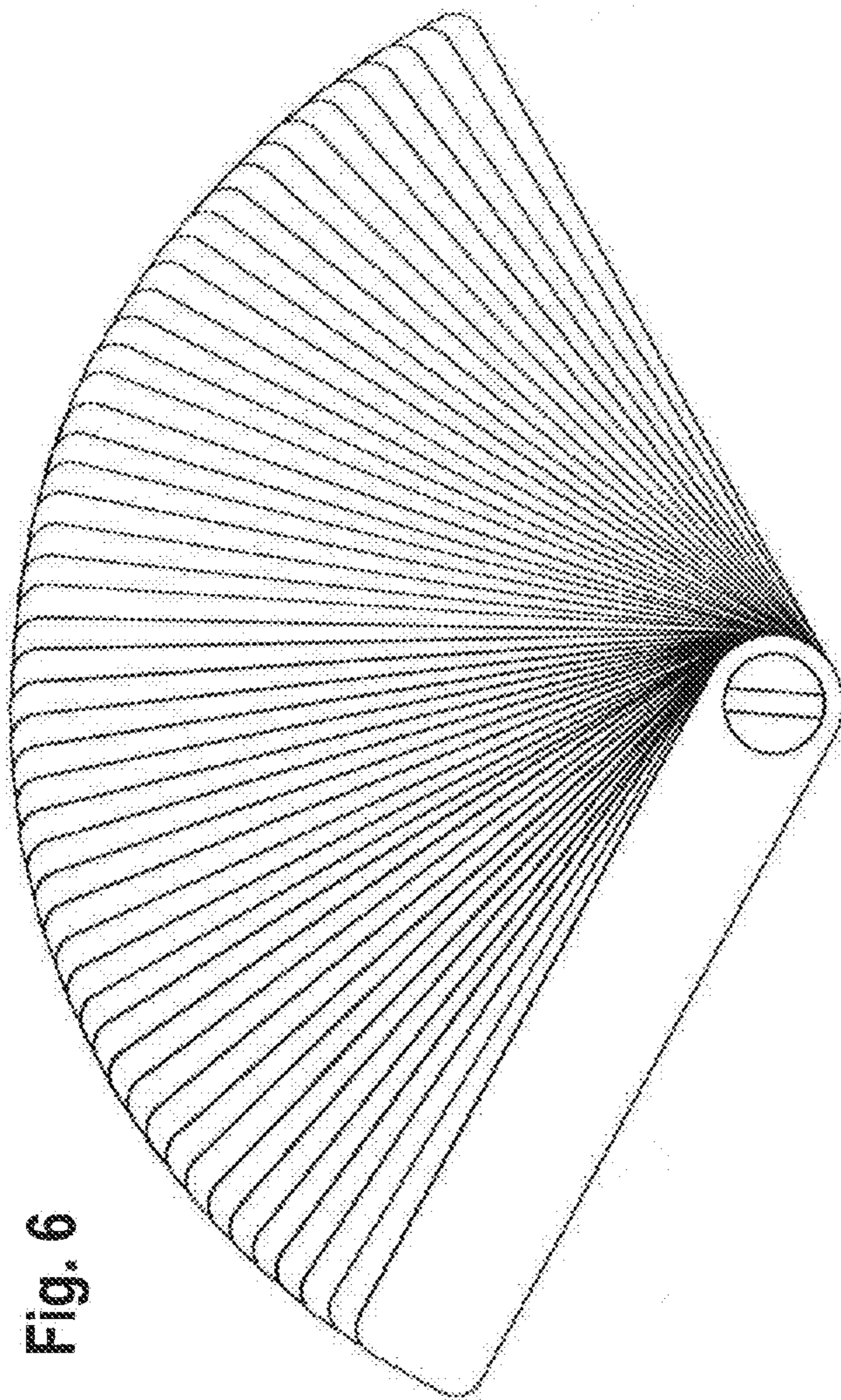

Fig. 6

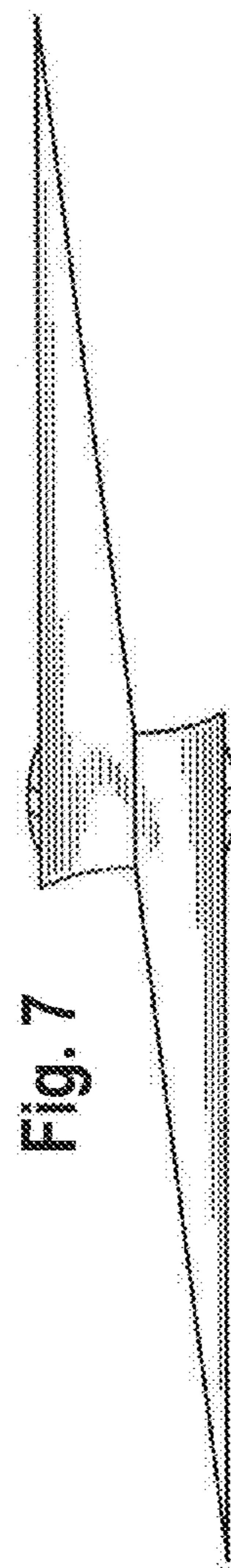

Fig. 7

Fig. 8

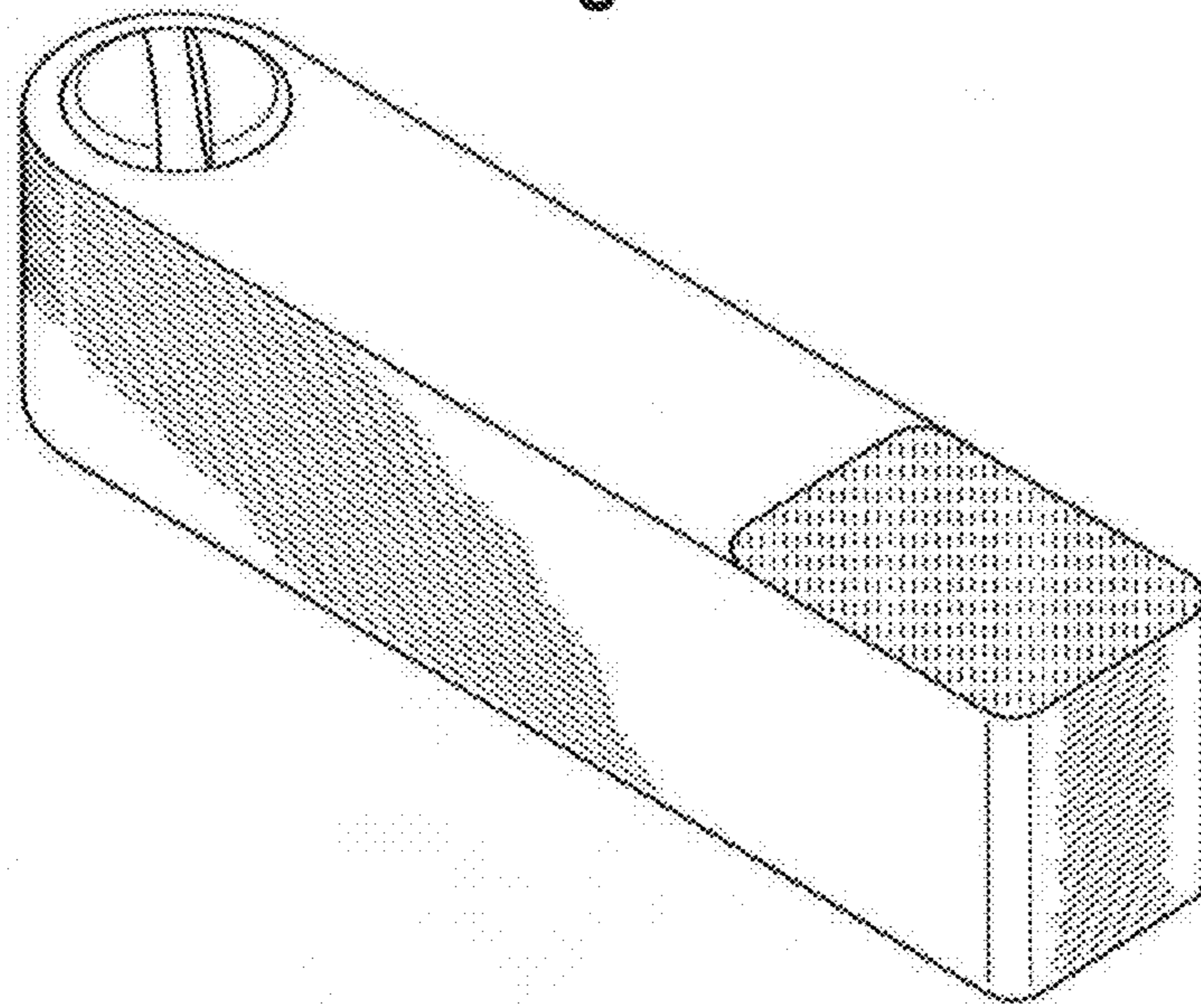

Fig. 9

