



US00D752283S

(12) **United States Design Patent**
Doster

(10) **Patent No.:** **US D752,283 S**
(45) **Date of Patent:** **** Mar. 22, 2016**

(54) **ELECTRONIC CIGARETTE CASING**

(71) Applicant: **Paradise Packaging Inc.**, Orchard Park, NY (US)

(72) Inventor: **Gary Doster**, Orchard Park, NY (US)

(73) Assignee: **Paradise Packaging Inc.**, Orchard Park, NY (US)

(**) Term: **14 Years**

(21) Appl. No.: **29/507,489**

(22) Filed: **Oct. 28, 2014**

(51) **LOC (10) Cl.** **27-06**

(52) **U.S. Cl.**
USPC **D27/189**

(58) **Field of Classification Search**
USPC D3/229, 273; D9/414, 418, 420, 430, D9/432; D27/172, 183–193, 180–182; D13/107, 108, 109
CPC A24F 15/00; A24F 15/005; A24F 15/02; A24F 15/12; A24F 15/14; A24F 15/18; A24F 15/20; A24F 23/00; A24F 23/02; A24F 23/04; B65D 85/1045; B65D 85/1063; B65D 85/1072; B65D 5/0254
See application file for complete search history.

(56) **References Cited**

U.S. PATENT DOCUMENTS

192,579	A *	7/1877	Harlow	A24F 23/04 206/240
D35,022	S *	9/1901	Rehmann	D27/173
697,601	A *	4/1902	Biren	A24F 27/00 206/102
799,844	A *	9/1905	Fuller	A24F 27/10 206/134
1,771,113	A *	7/1930	Durnen	A24F 15/18 221/148
2,148,319	A *	2/1939	Negbauer	A24F 15/12 206/259

D346,878	S *	5/1994	Gee	D27/194
D366,950	S *	2/1996	McKinnie	D27/189
D410,764	S *	6/1999	Wilson	D27/172
D412,279	S *	7/1999	Brice	D7/629
D446,601	S *	8/2001	Fisher	D27/129
D449,782	S *	10/2001	Diaz	D7/629
D472,772	S *	4/2003	Noble	D7/629
D591,899	S *	5/2009	Bray	D27/189
D668,535	S *	10/2012	Collins	D9/423
D681,445	S *	5/2013	van Landsveld	D9/423
D693,670	S *	11/2013	van Landsveld	D9/423
D708,727	S *	7/2014	Postma	D23/360
8,794,434	B2 *	8/2014	Scatterday	A24F 15/12 206/256
D718,106	S *	11/2014	Lauzet	D8/33
D725,823	S *	3/2015	Scatterday	D27/189
9,078,472	B2 *	7/2015	Liu	A24F 15/18
9,089,166	B1 *	7/2015	Scatterday	A24F 15/12
2005/0236282	A1 *	10/2005	Huska	A24F 13/18 206/246
2014/0053858	A1 *	2/2014	Liu	A24F 15/18 131/329

* cited by examiner

Primary Examiner — Elizabeth Albert

(74) *Attorney, Agent, or Firm* — Roach Brown McCarthy & Gruber, P.C.; Kevin D. McCarthy

(57) **CLAIM**

The ornamental design for an electronic cigarette casing, as shown and described.

DESCRIPTION

FIG. 1 is a perspective view of the front, top, and right side view of an electronic cigarette casing showing my design; FIG. 2 is a perspective view of the back, bottom, and left side view thereof; FIG. 3 is a front view thereof; FIG. 4 is a right side view thereof; FIG. 5 is a left side view thereof; FIG. 6 is a top side view thereof; and, FIG. 7 is a bottom side view thereof.

1 Claim, 5 Drawing Sheets

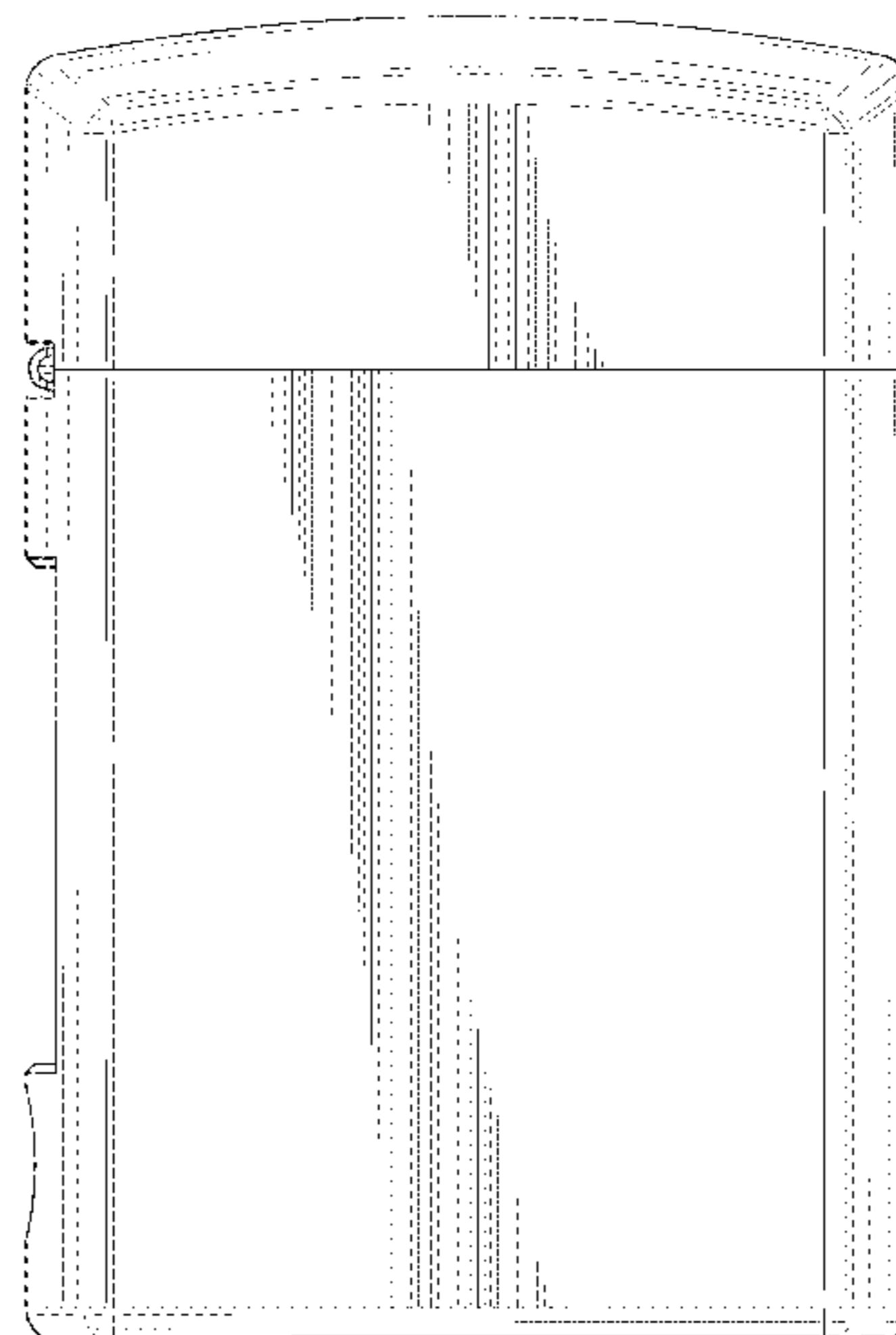
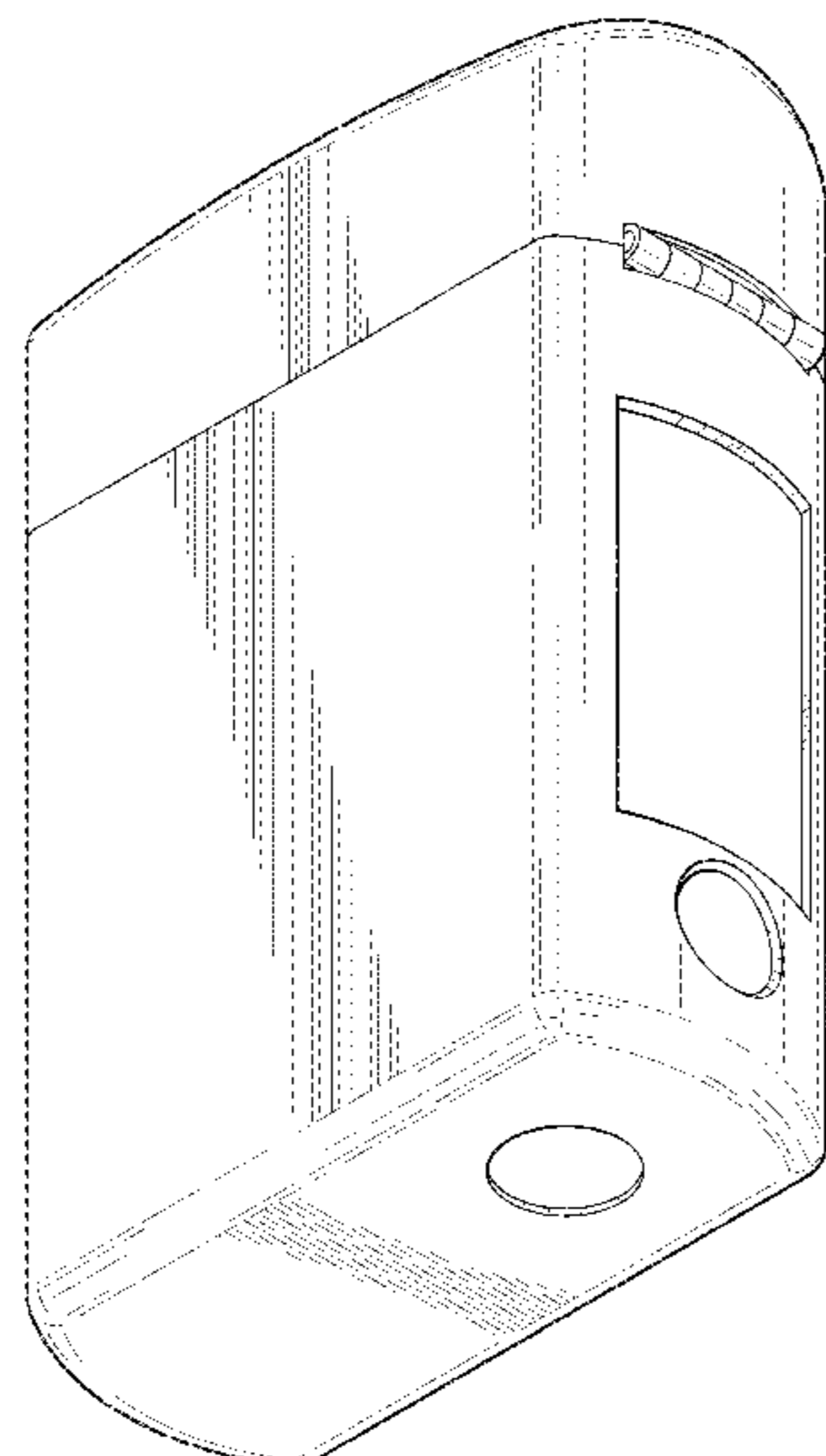

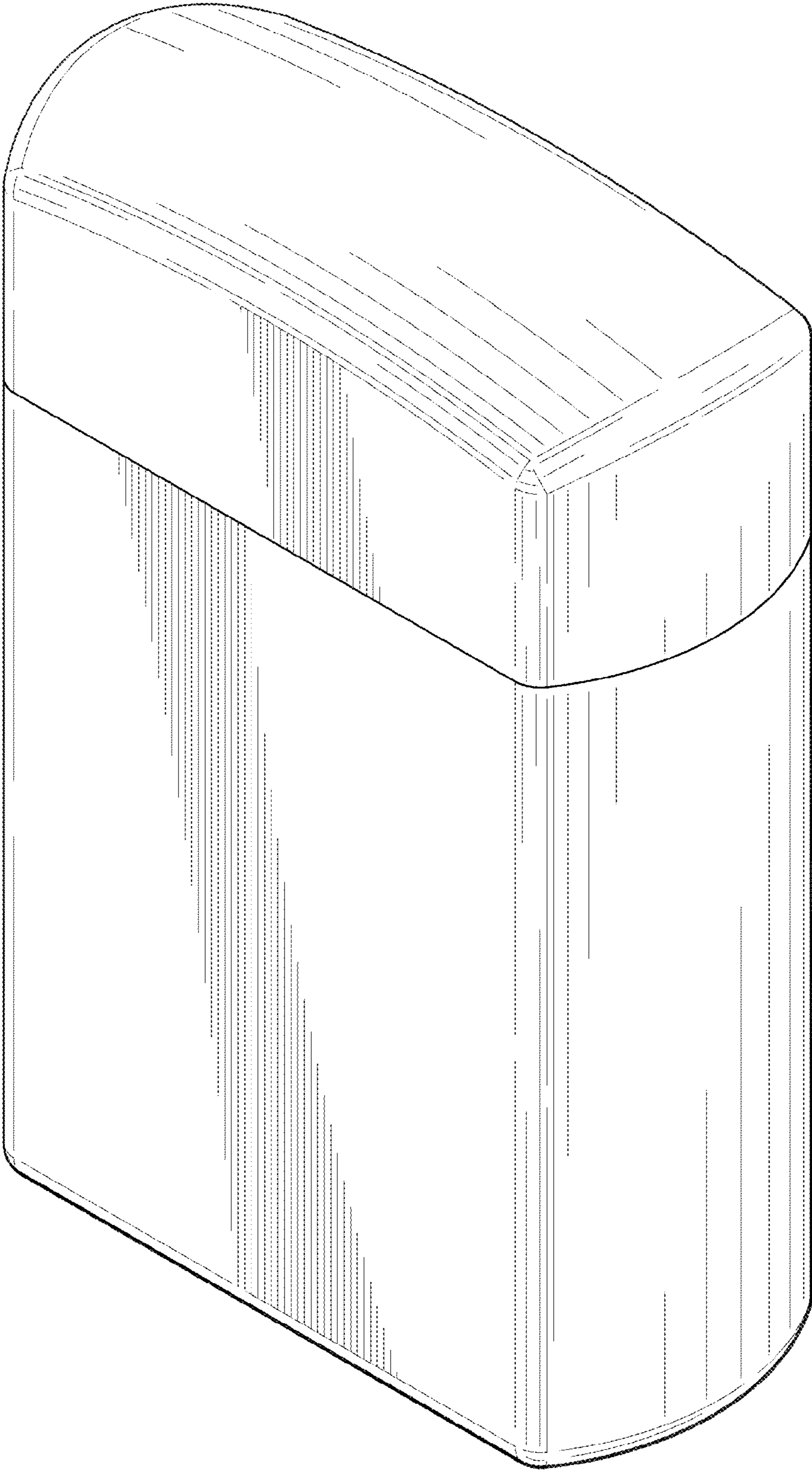

FIG. 1

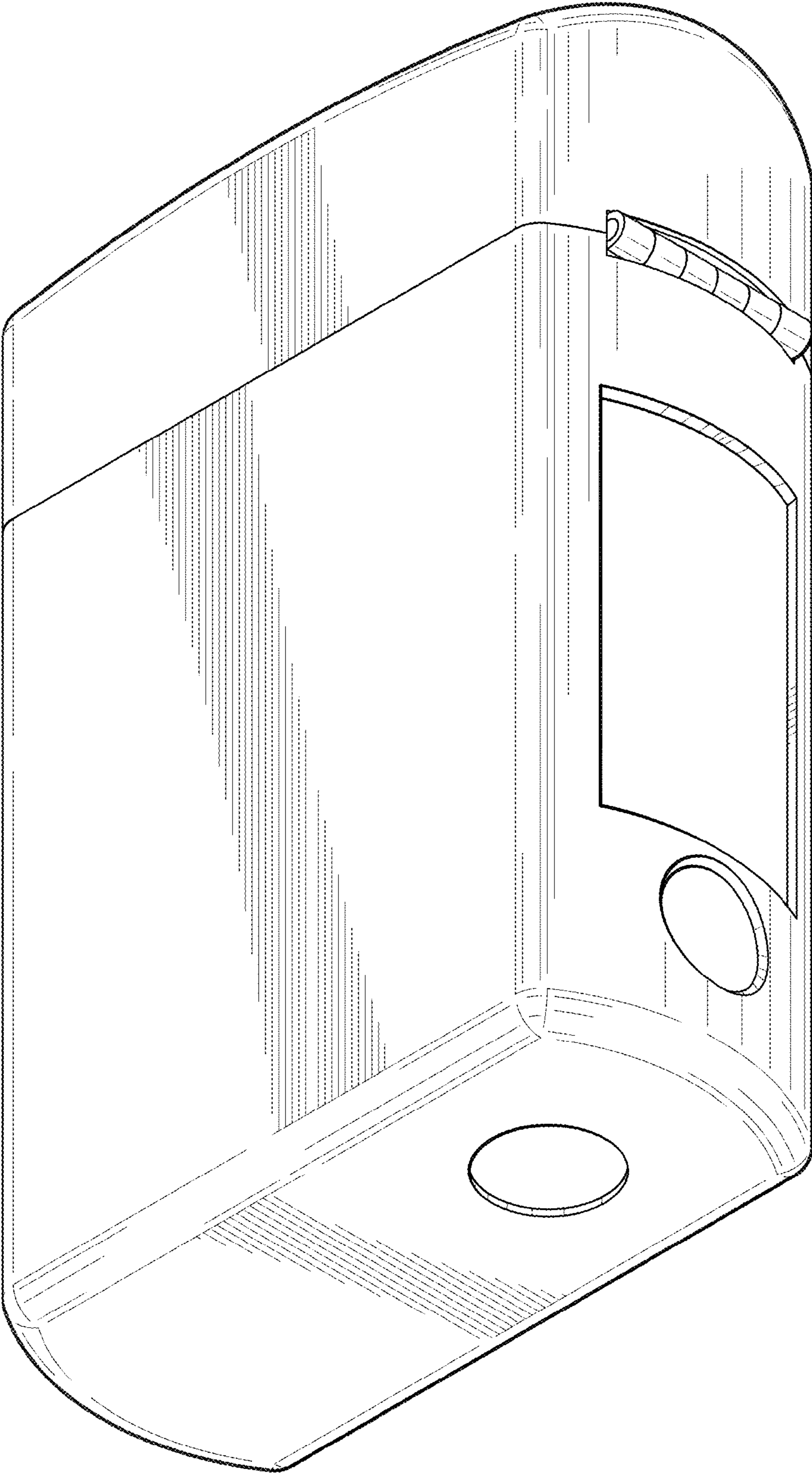

FIG. 2

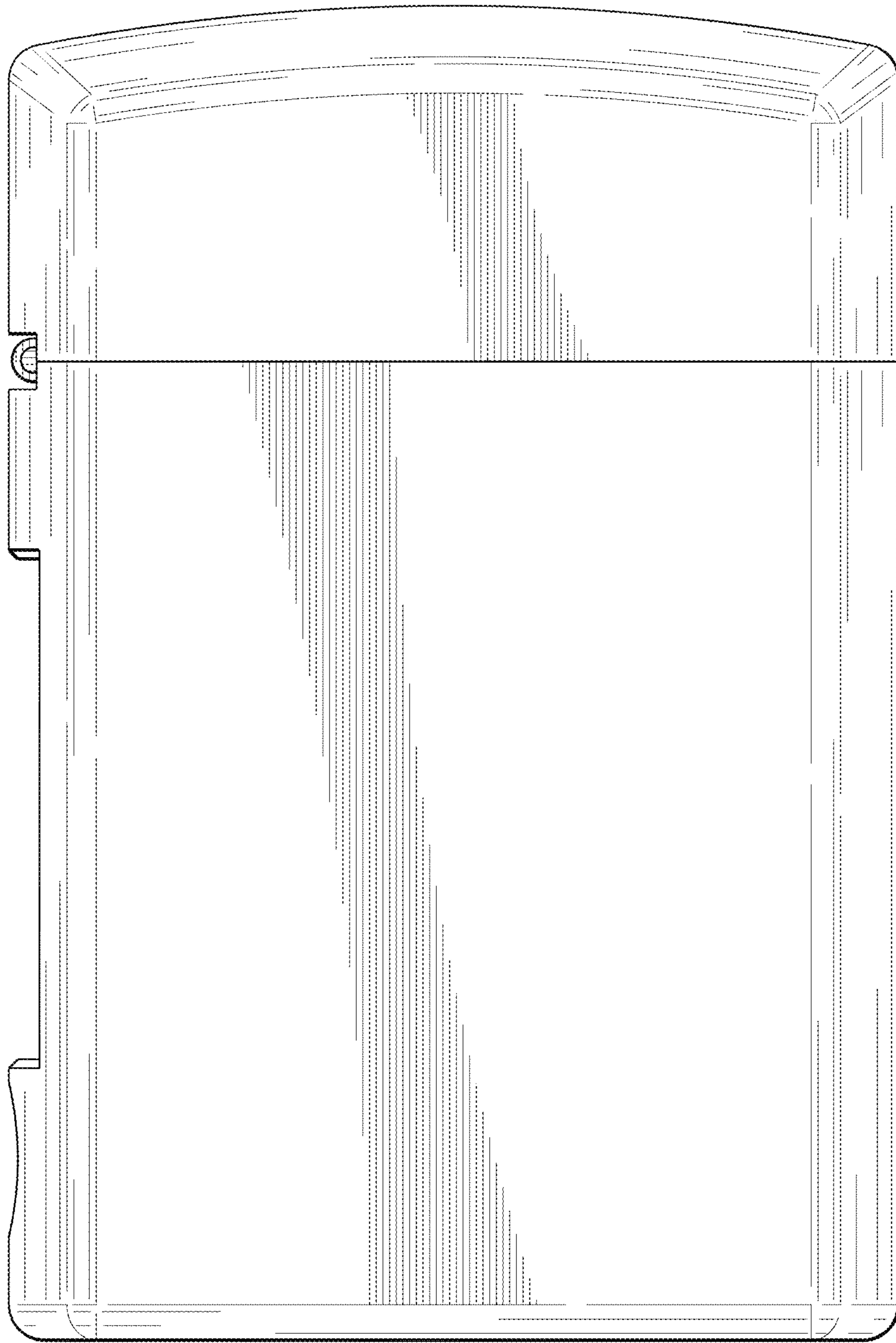

FIG. 3

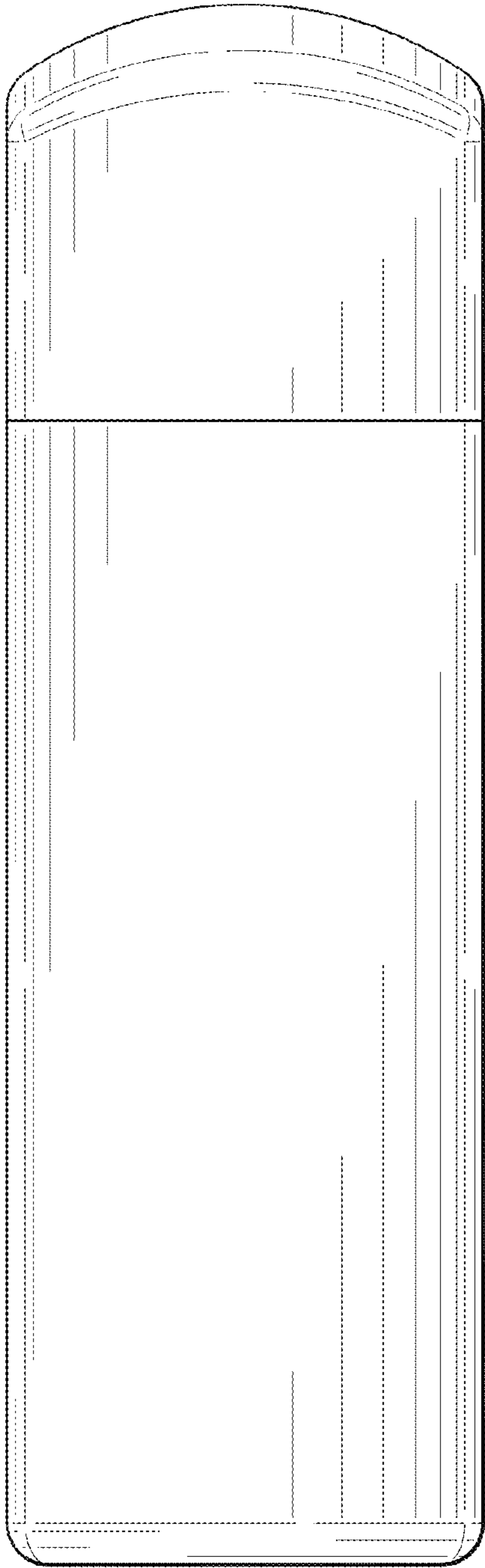

FIG. 4

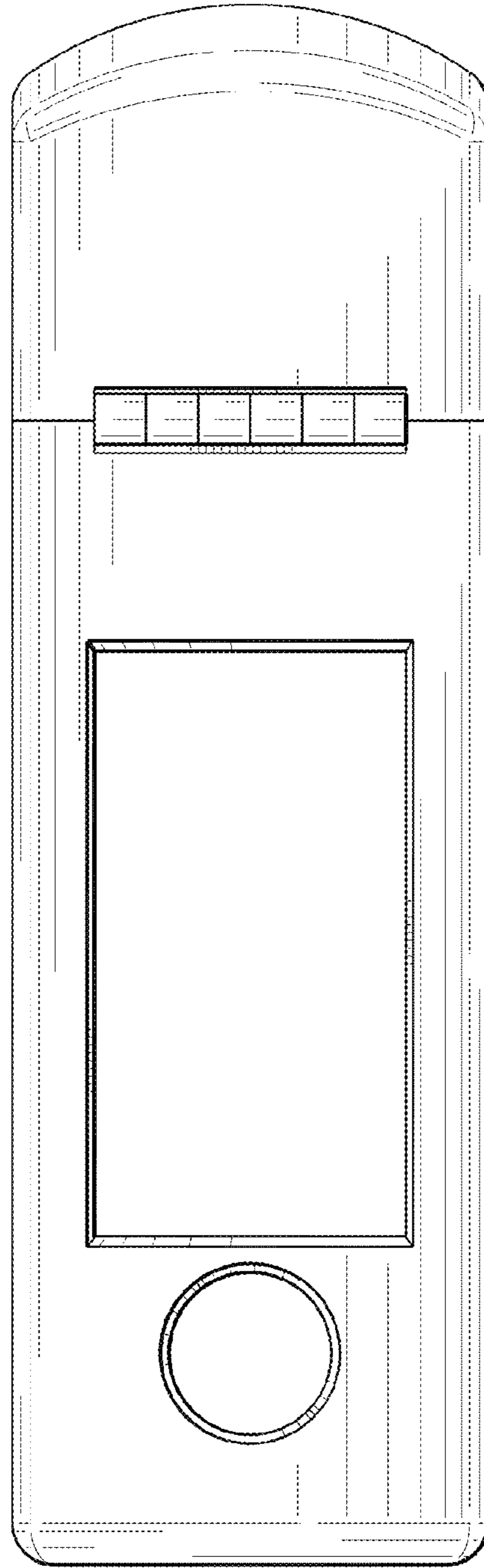

FIG. 5

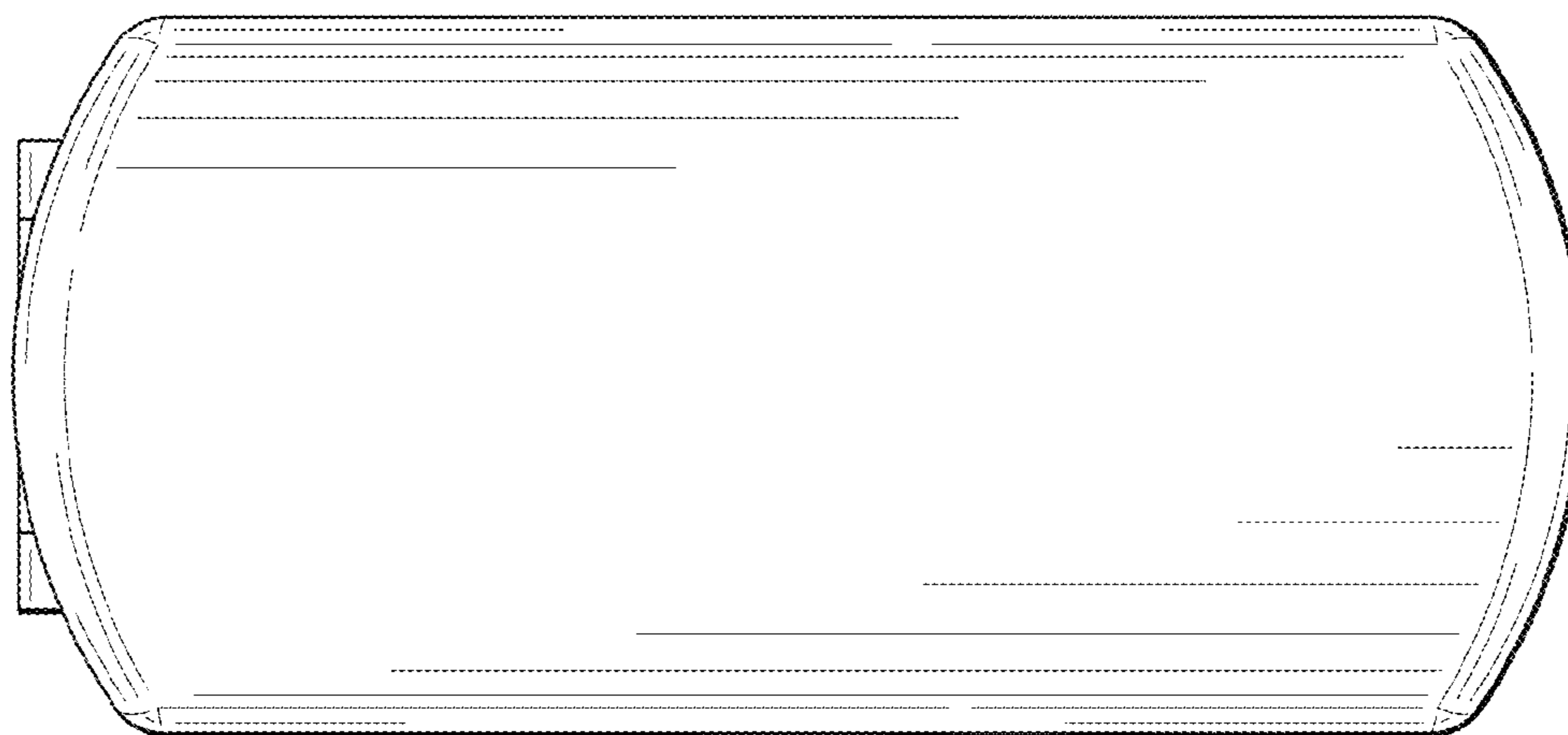

FIG. 6

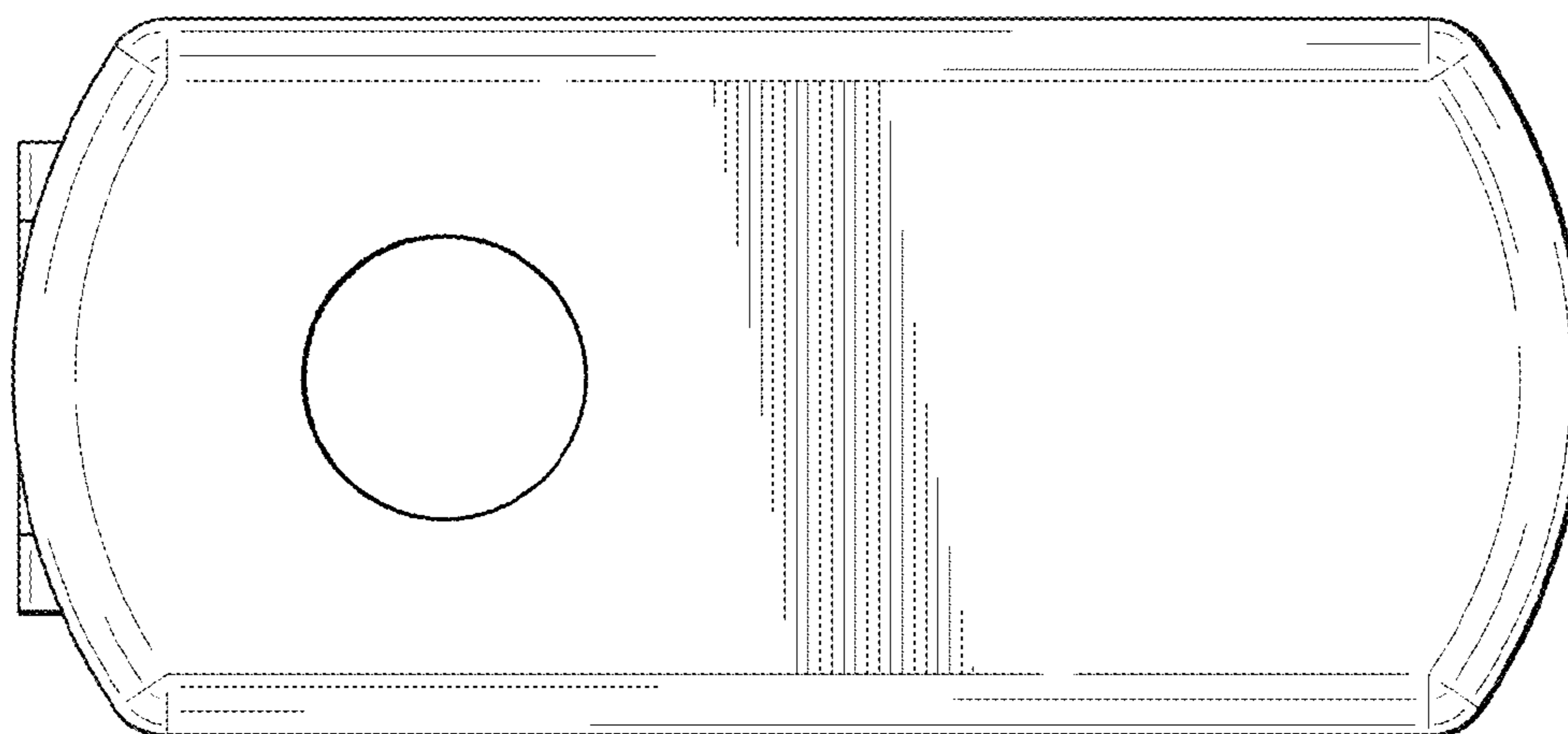

FIG. 7