



US00D752233S

(12) **United States Design Patent**  
**Fruscione-Loizides**

(10) **Patent No.:** **US D752,233 S**  
(45) **Date of Patent:** **\*\* Mar. 22, 2016**

(54) **POSTPARTUM ABDOMINAL SUPPORT**

(71) Applicant: **Thinking Tiger, LLC**, Hamilton, NJ  
(US)

(72) Inventor: **Gia Fruscione-Loizides**, Skillman, NJ  
(US)

(73) Assignee: **THINKING TIGER, LLC**, Hamilton,  
NJ (US)

(\*\*) Term: **14 Years**

(21) Appl. No.: **29/495,556**

(22) Filed: **Jul. 2, 2014**

**Related U.S. Application Data**

(63) Continuation-in-part of application No. 14/195,850,  
filed on Mar. 3, 2014, now Pat. No. 9,161,854.

(51) **LOC (10) Cl.** ..... **24-04**

(52) **U.S. Cl.**  
USPC ..... **D24/190**

(58) **Field of Classification Search**  
USPC ..... D24/188, 190, 200, 206; D29/100,  
D29/101.3, 101.5  
CPC ..... A61F 5/028; A61F 7/02; A61F 5/03;  
A61F 2007/0001

See application file for complete search history.

(56) **References Cited**

**U.S. PATENT DOCUMENTS**

3,115,879 A *	12/1963	Kaplan	.....	A61F 5/03 450/117
3,442,270 A	5/1969	Steinman		
3,529,601 A *	9/1970	Kirkland	.....	A61F 5/03 601/1
3,554,190 A *	1/1971	Kaplan	.....	A61F 5/03 2/44
3,570,480 A	3/1971	Stubbs		
3,598,114 A	8/1971	Lewis		
3,603,316 A	9/1971	Lehman		

3,752,163 A	8/1973	Kaplan		
3,812,862 A	5/1974	Bernstein		
3,920,008 A	11/1975	Lehman		
4,459,979 A *	7/1984	Lewis, Jr.	.....	A61F 13/148 602/19

D278,083 S 3/1985 Meier  
(Continued)

**FOREIGN PATENT DOCUMENTS**

CN	201692113 U	1/2011
CN	202437411 U	9/2012
WO	2007041243 A2	4/2007

**OTHER PUBLICATIONS**

“Postpartum 3 Velcro Straps Reinforced Girdle.” <http://summerglitz.com/my/postpartum-3-velcro-straps-reinforced-girdle-band-s-m-white.html#.UuBZXftMFkg>.

(Continued)

*Primary Examiner* — George D Kirschbaum

*Assistant Examiner* — Jennifer Watkins

(74) *Attorney, Agent, or Firm* — Roberts & Roberts, LLP

(57) **CLAIM**

The ornamental design for a postpartum abdominal support, as shown and described.

**DESCRIPTION**

FIG. 1 is a right side view of a postpartum abdominal support, showing my new design in use.

FIG. 2 is a front view of the postpartum abdominal support.

FIG. 3 is a rear view thereof.

FIG. 4 is a left side view thereof; and,

FIG. 5 is a rear perspective view thereof.

The unevenly dashed broken lines in FIG. 1 are for the purpose of illustrating portions of a human form that form no part of the claim. The evenly dashed lines in FIG. 5 represent portions of the postpartum abdominal support that form no part of the claim.

**1 Claim, 3 Drawing Sheets**

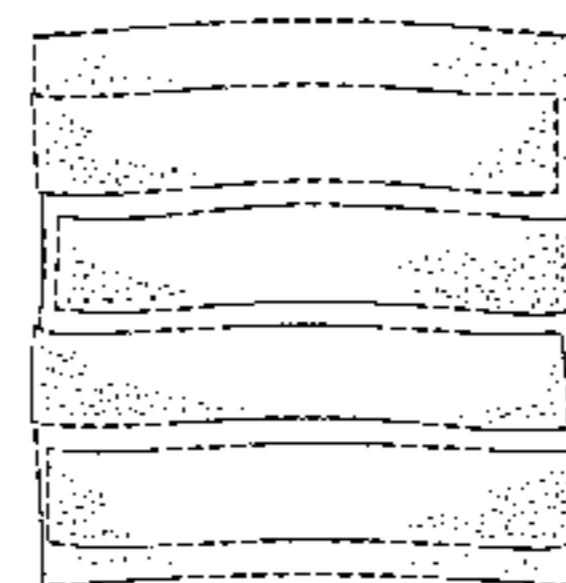
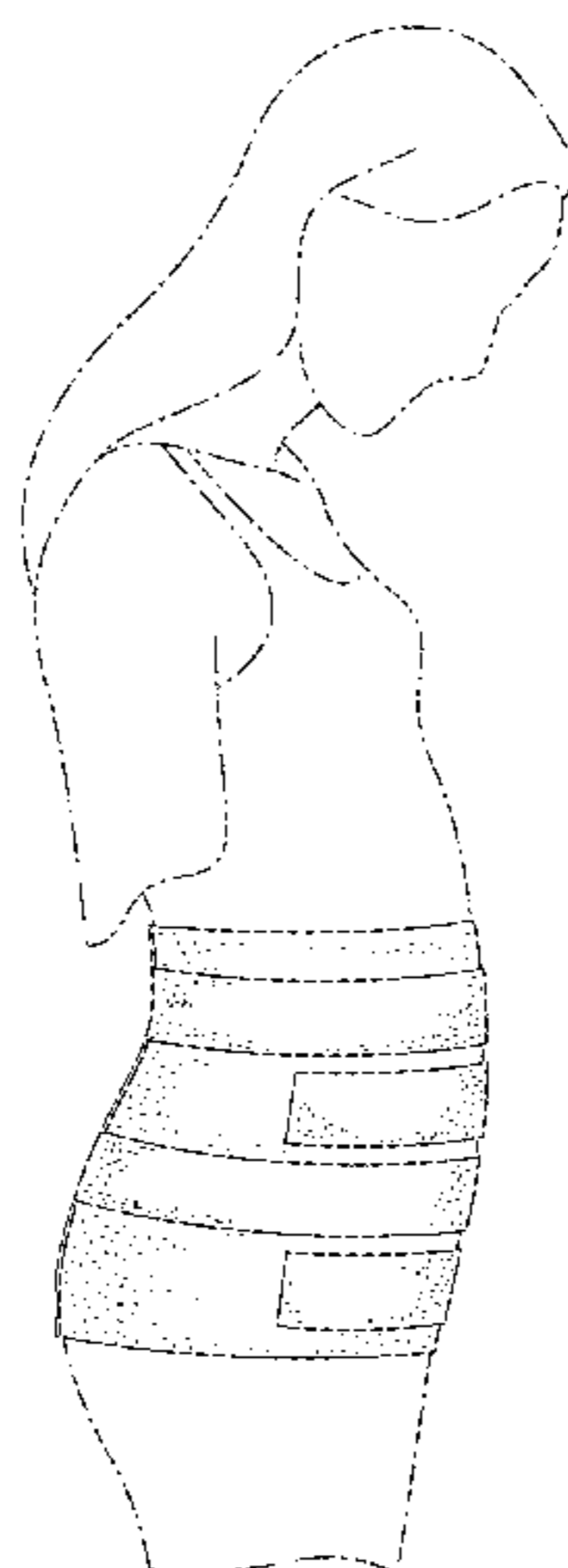

(56)

**References Cited**

U.S. PATENT DOCUMENTS

4,527,566 A 7/1985 Abare  
 D296,930 S 7/1988 Carabelli  
 4,787,381 A \* 11/1988 Hubbard ..... A61F 13/148  
 139/421  
 4,833,730 A \* 5/1989 Nelson ..... A61F 5/028  
 2/44  
 D306,364 S 2/1990 Hamilton  
 5,040,526 A \* 8/1991 Erickson ..... A61F 13/143  
 2/44  
 5,188,585 A \* 2/1993 Peters ..... A61F 5/028  
 128/100.1  
 5,533,963 A \* 7/1996 Hall ..... A61F 5/03  
 128/100.1  
 D404,490 S 1/1999 Tripolsky  
 6,309,369 B1 \* 10/2001 Lebovic ..... A61F 13/145  
 602/19  
 6,585,673 B1 7/2003 Bass  
 6,921,375 B2 7/2005 Kihara  
 7,160,262 B2 1/2007 Wicks  
 7,425,171 B2 9/2008 Maupin  
 D628,300 S 11/2010 Caden

D660,439 S 5/2012 Chen et al.  
 D665,470 S 8/2012 Galbraith  
 8,430,830 B1 4/2013 Ariza  
 D728,804 S \* 5/2015 Hansen ..... D24/190  
 2004/0132380 A1 \* 7/2004 Kihara ..... A61F 5/028  
 450/154  
 2013/0116609 A1 5/2013 Matsuo et al.  
 2013/0178774 A1 7/2013 Hayes  
 2015/0094638 A1 \* 4/2015 Hansen ..... A61F 5/03  
 602/53

OTHER PUBLICATIONS

“Style 70 Support Garment,” ContourMD.com <http://www.contourmd.com/Style-70-12in-Abdominal-Binder-Adjustable-Panel-Contour>.  
 Shrinkx Belly Postpartum Belly Band by UpSpring Baby. <http://www.shrinkxbelly.com/how-to-wear>.  
 “AbdoMend Support Belt and Strap.” <http://maternity.about.com/od/thefourthtrimester/tp/4-Post-Partum-Support-Belts-To-Try.htm?p=1>.  
 U.S. Appl. No. 14/195,850, filed Mar. 3, 2014, Loizides.

\* cited by examiner

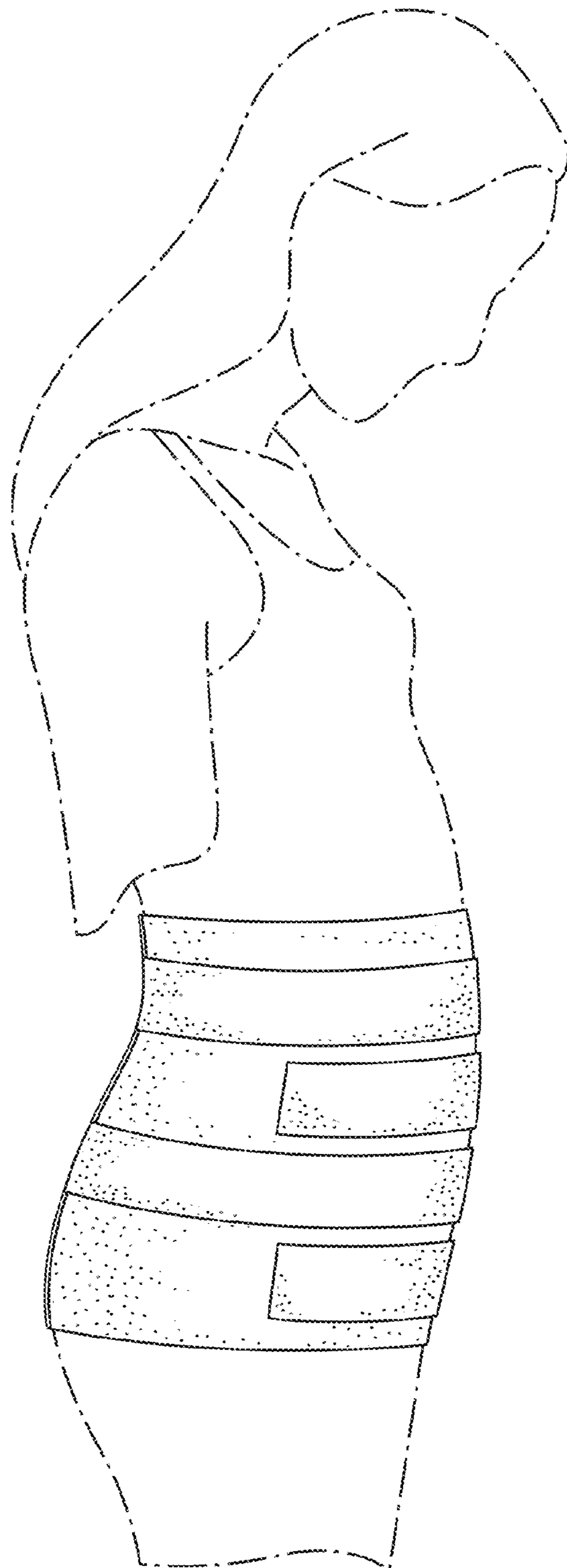

FIG. 1

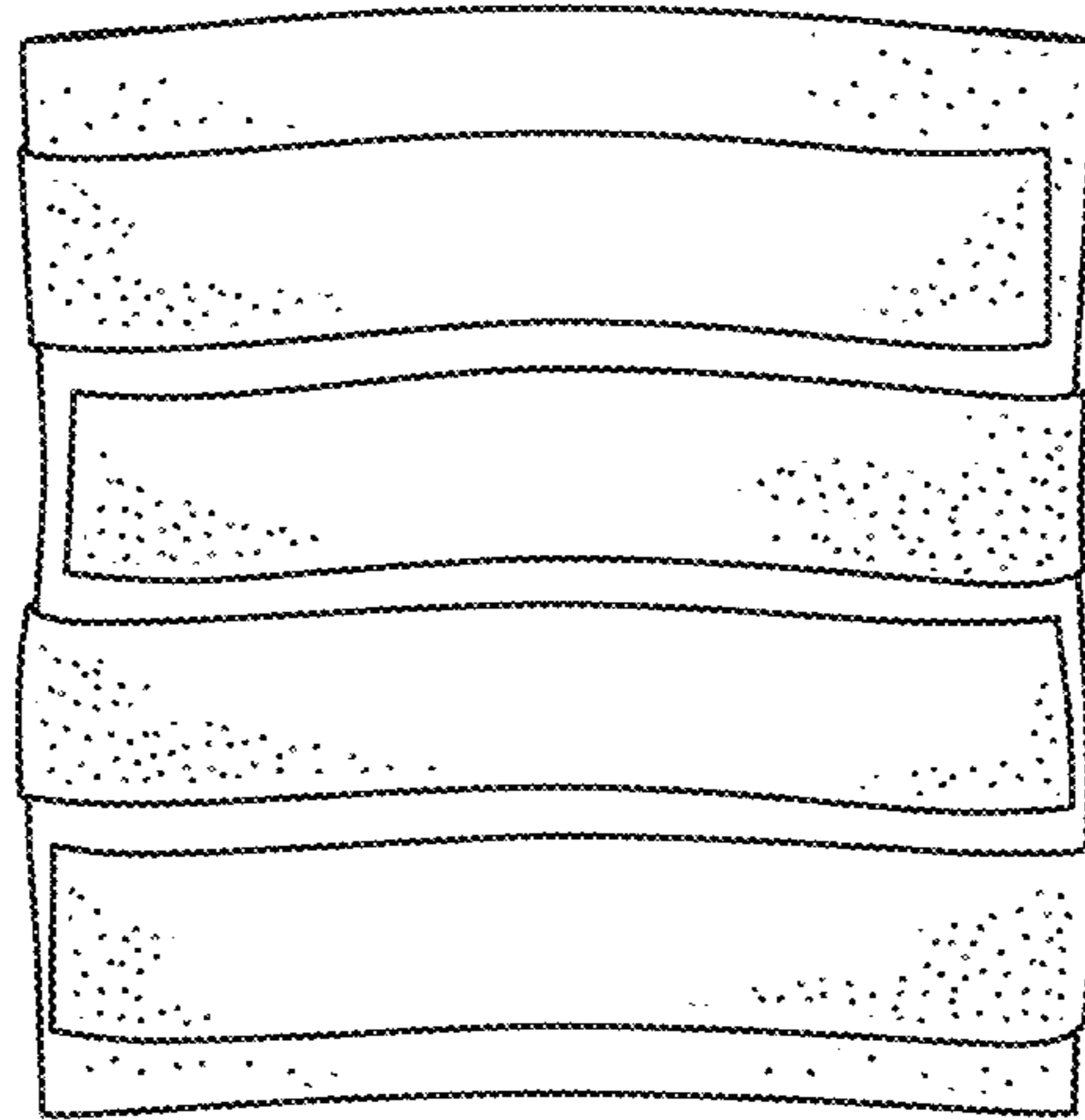

FIG. 2

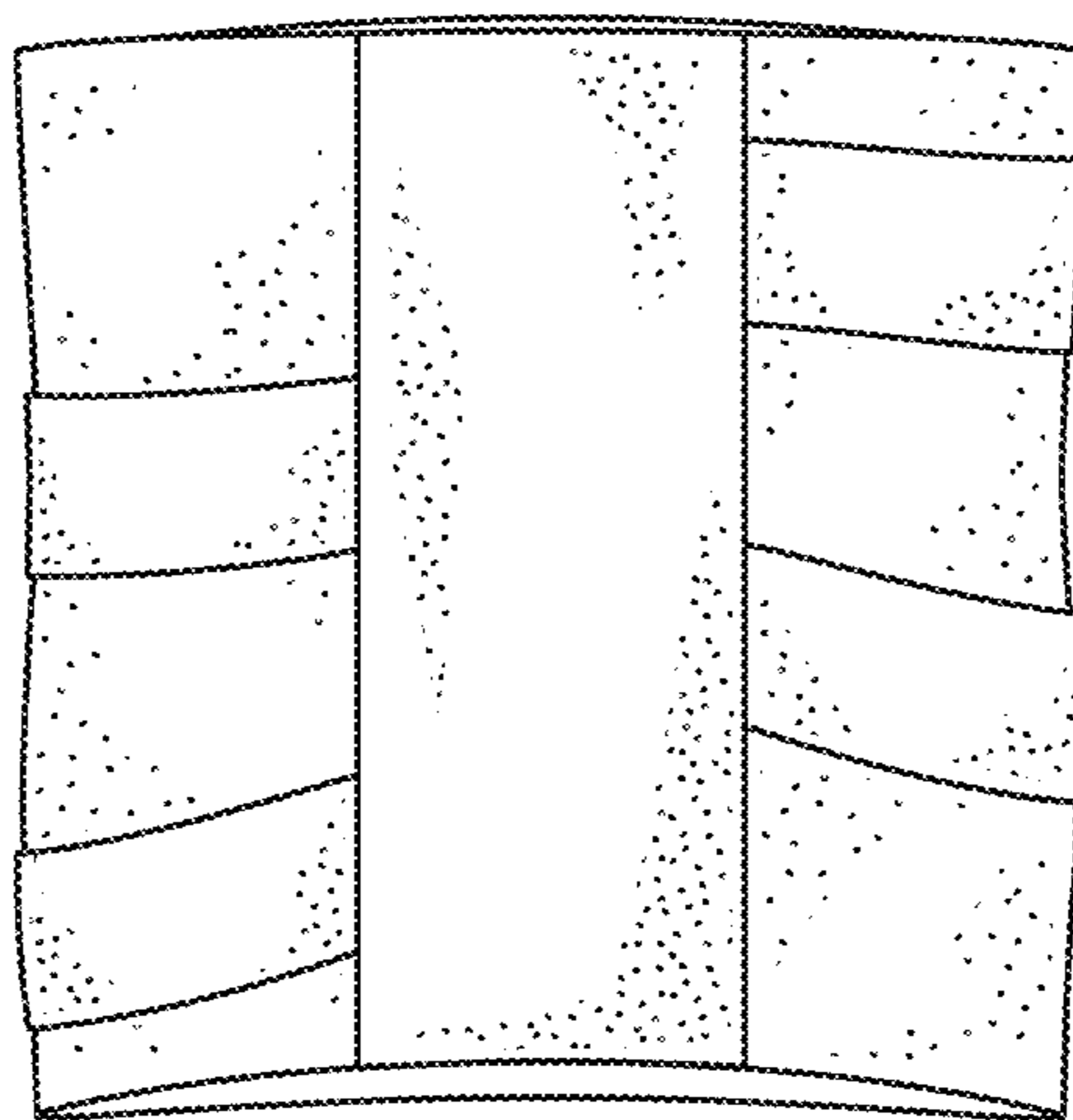

FIG. 3

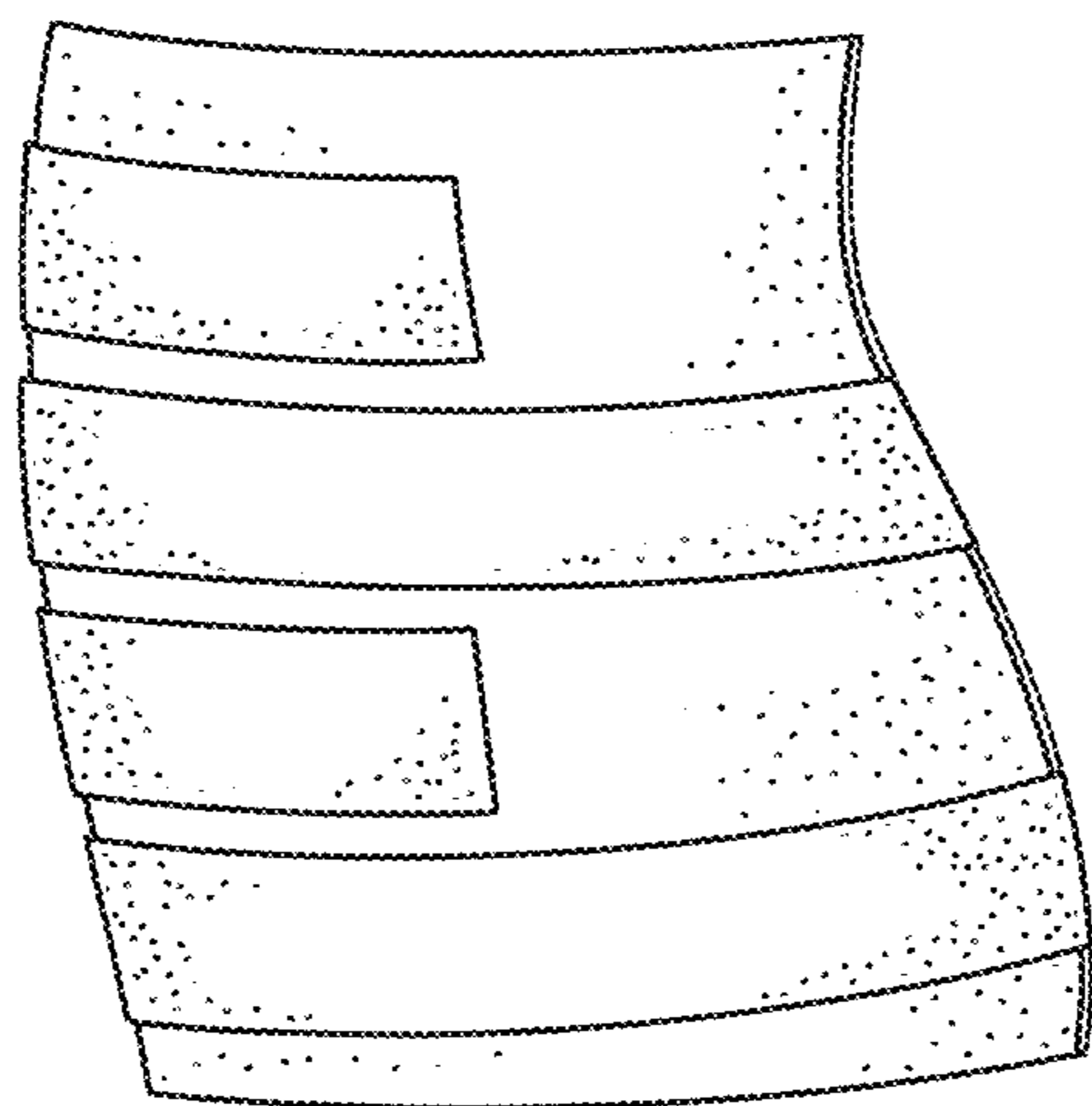

FIG. 4

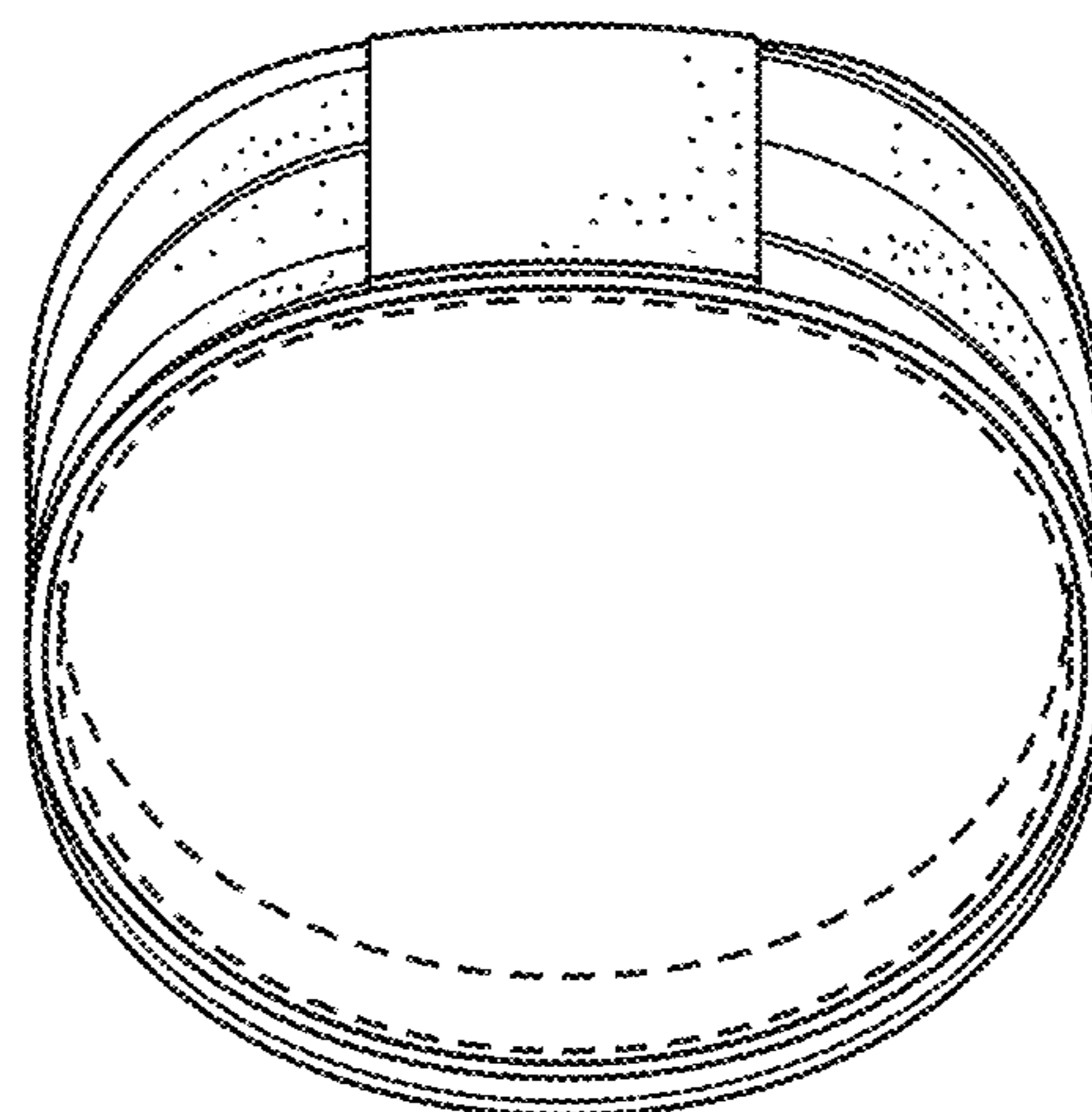

FIG. 5