



US00D752198S

(12) **United States Design Patent**  
**Zach et al.**

(10) **Patent No.:** **US D752,198 S**  
(45) **Date of Patent:** **\*\* Mar. 22, 2016**

(54) **TOILET RIM BLOCK HOLDER**  
(71) Applicant: **S. C. Johnson & Son, Inc.**, Racine, WI (US)  
(72) Inventors: **Steven A. Zach**, Waterford, WI (US);  
**Douglas A. Soller**, Racine, WI (US);  
**Jose Conti**, Lake Villa, IL (US)  
(73) Assignee: **S.C. Johnson & Son, Inc.**, Racine, WI (US)

6,675,396 B2 1/2004 Varanasi et al.  
D507,628 S 7/2005 McLellan et al.  
6,934,973 B2 8/2005 Lehmann et al.  
D536,059 S 1/2007 King et al.  
D540,454 S 4/2007 Ruiz Ballesteros et al.

(Continued)

FOREIGN PATENT DOCUMENTS

CN 1995216318 7/1995  
CN 2000250078 9/2000

(Continued)

(\*\*) Term: **14 Years**

OTHER PUBLICATIONS

(21) Appl. No.: **29/520,904**

Pictures of S.C. Johnson & Son, Inc. Toilet Rim Block Holder, published date unknown, but prior to the filing date of the present application.

(22) Filed: **Mar. 18, 2015**

(Continued)

(51) **LOC (10) Cl.** ..... **28-99**

(52) **U.S. Cl.**

USPC ..... **D23/368**; D23/208

(58) **Field of Classification Search**

USPC ..... D23/355-369, 208; D28/5, 6;  
261/DIG. 17, DIG. 42, DIG. 65, DIG. 88,  
261/DIG. 89; 392/386, 390, 394, 395, 392;  
239/34, 44, 53, 55, 56, 326; D7/300,  
D7/300.1, 584

CPC ..... A61L 9/00; A61L 9/02; A61L 9/03;  
A61L 9/032; A61L 9/035; A61L 9/037;  
A61L 9/04; A61L 9/12; A61L 9/22

See application file for complete search history.

Primary Examiner — Sandra Snapp

(57) **CLAIM**

The ornamental design for a toilet rim block holder, as shown and described.

**DESCRIPTION**

FIG. 1 is a top, front, left perspective view of a toilet rim block holder showing our new design; FIG. 2 is a front view thereof; FIG. 3 is a rear view thereof; FIG. 4 is a right side view thereof; FIG. 5 is a top view thereof; and, FIG. 6 is a bottom view thereof.

The broken lines immediately adjacent to the shaded area represent unclaimed boundaries of the design. The unshaded regions within the shaded area form no part of the claimed design. The broken lines showing the remainder of the toilet rim block holder are for environmental purposes only and form no part of the claimed design.

**1 Claim, 4 Drawing Sheets**

(56) **References Cited**

U.S. PATENT DOCUMENTS

1,974,955 A 9/1934 Foltis  
6,311,340 B1 11/2001 Thompson  
D456,888 S 5/2002 Buthier  
D461,006 S 7/2002 Buthier  
D464,107 S 10/2002 Holmes et al.  
6,505,356 B1 1/2003 Leonard et al.  
6,519,783 B2 2/2003 Falchieri  
6,647,558 B2 11/2003 Falchieri  
6,651,261 B1 11/2003 Leonard et al.

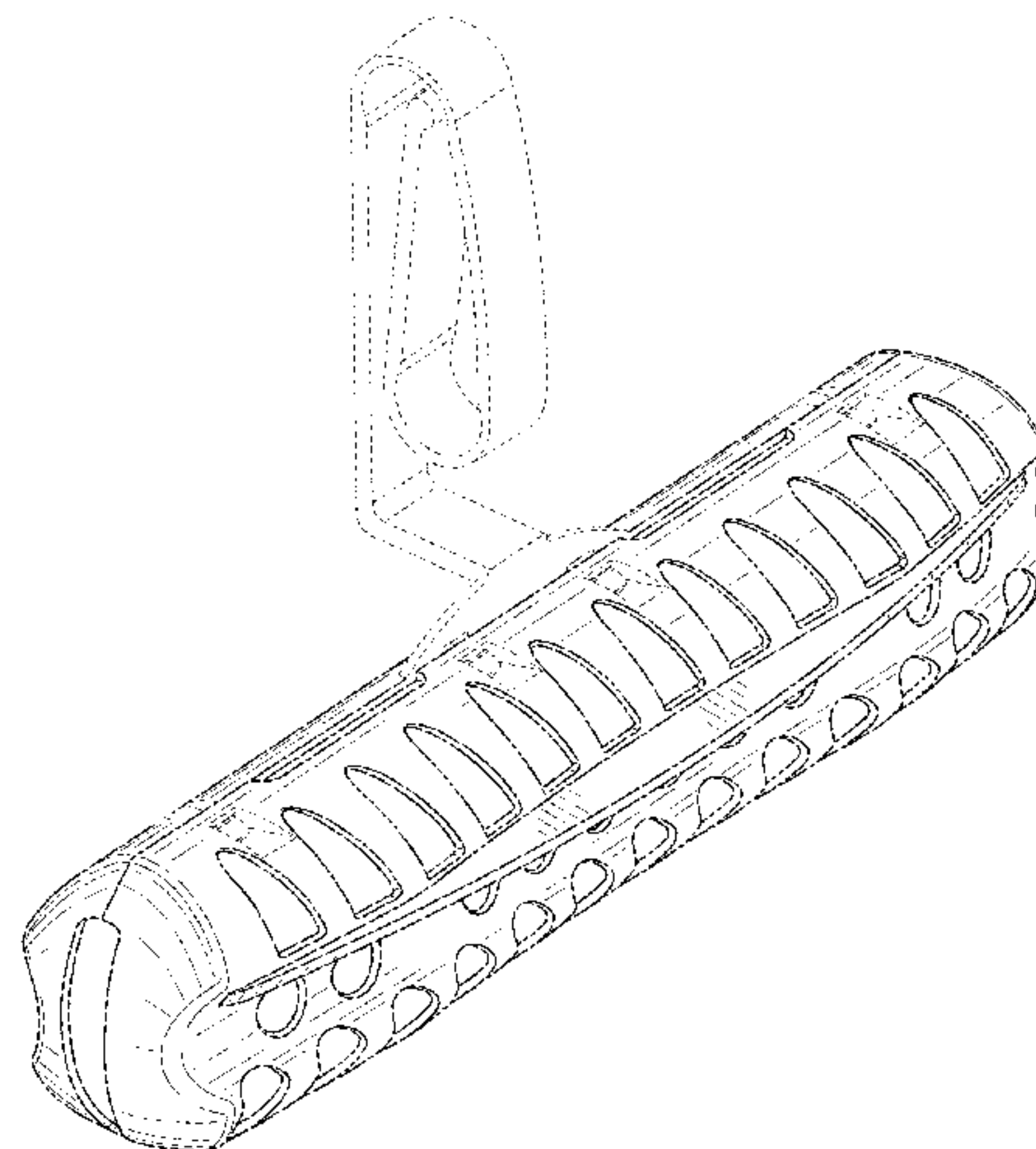

(56)

References Cited

U.S. PATENT DOCUMENTS

D541,902 S 5/2007 Cheung et al.  
 D555,757 S 11/2007 Cheung et al.  
 D574,922 S 8/2008 Cheung et al.  
 D583,902 S 12/2008 Cheung et al.  
 D594,953 S 6/2009 King et al.  
 D603,950 S \* 11/2009 Brown ..... D23/366  
 D613,368 S 4/2010 Padain et al.  
 7,788,740 B2 9/2010 De Belder et al.  
 D640,359 S \* 6/2011 Irvin ..... D23/366  
 7,971,284 B2 7/2011 Pessel et al.  
 D646,769 S \* 10/2011 Angel ..... D23/366  
 8,051,503 B2 11/2011 Nguyen et al.  
 D650,892 S \* 12/2011 Wheatley ..... D23/366  
 D655,778 S 3/2012 Muhlhausen  
 D656,575 S 3/2012 Muhlhausen  
 D656,576 S 3/2012 Muhlhausen  
 D659,793 S 5/2012 Muhlhausen  
 8,181,282 B2 5/2012 Butter-Jentsch et al.  
 D662,174 S 6/2012 Reijnders  
 8,316,471 B2 11/2012 Pessel et al.  
 D679,778 S 4/2013 Gerhards  
 D689,167 S 9/2013 Gerhards  
 D698,004 S 1/2014 Bruining et al.  
 8,695,124 B2 4/2014 Hsu  
 D720,427 S 12/2014 Wang et al.  
 D720,428 S 12/2014 Wang et al.  
 D720,830 S 1/2015 Wang et al.  
 D722,154 S 2/2015 Muller et al.  
 D735,026 S \* 7/2015 Evans ..... D9/414  
 D740,649 S \* 10/2015 Evans ..... D9/414  
 2001/0004775 A1 6/2001 Falchieri  
 2002/0083514 A1 7/2002 Lhoste  
 2002/0178493 A1 12/2002 Varanasi et al.  
 2003/0088908 A1 5/2003 Falchieri  
 2003/0207964 A1 11/2003 Gazzaniga et al.  
 2004/0068782 A1 4/2004 Butter-Jentsch et al.  
 2004/0107484 A1 6/2004 Butter-Jentsch et al.  
 2005/0014668 A1 1/2005 Bariou et al.  
 2006/0137081 A1 6/2006 Ferrara et al.  
 2007/0204387 A1 9/2007 Cornelius et al.  
 2008/0313795 A1 12/2008 Lu  
 2010/0192291 A1 8/2010 Burt et al.  
 2010/0212074 A1 8/2010 Burt et al.  
 2010/0299818 A1 12/2010 Lu  
 2011/0099698 A1 5/2011 Butter-Jentsch et al.  
 2012/0047640 A1 3/2012 Warkotsch et al.  
 2012/0266368 A1 10/2012 Butter-Jentsch et al.  
 2012/0266369 A1 10/2012 Butter-Jentsch et al.  
 2012/0266370 A1 10/2012 Butter-Jentsch et al.  
 2013/0104304 A1 5/2013 Wilson et al.  
 2013/0239313 A1 9/2013 Schiedel et al.

FOREIGN PATENT DOCUMENTS

CN 2006260877 6/2006  
 CN 2006260878 6/2006  
 CN 300980775 8/2009  
 DE 40105069-0001 11/2001  
 EM 001226989-0003 11/2010  
 EM 0019735790001 1/2012  
 EM 0019735790002 1/2012  
 EM 002133314-0001 A1 11/2012  
 EM 002251405-0001 6/2013  
 EM 001941667-0001 1/2014  
 EM 001941667-0002 1/2014  
 EM 002597542-0004 2/2015  
 EM 002597542-0008 2/2015

EM 002619361-0006 2/2015  
 EM 002619361-0008 2/2015  
 EP 0878586 A2 11/1998  
 EP 0940509 9/1999  
 EP 1334239 8/2003  
 EP 2132383 12/2009  
 EP 1789099 2/2010  
 EP 2183439 5/2010  
 EP 2227604 9/2010  
 EP 2305901 6/2011  
 EP 0019735790003 1/2012  
 EP 2305900 8/2013  
 ES I0151495 5/2002  
 ES D0500876-01 5/2005  
 FR 013262-001 8/2001  
 FR 013262-002 8/2001  
 GB 2097887 A 11/1982  
 GB 2100165 A 12/1982  
 GB 3018324 7/2005  
 GB 3018327 7/2005  
 KR 300761036.0000 9/2014  
 KR 300767264.0000 10/2014  
 RU 00084731 U1 3/2013  
 WO 9824988 A1 6/1998  
 WO 9840465 A1 9/1998  
 WO 0050699 8/2000  
 WO 00/77310 A2 12/2000  
 WO 2004010833 A2 2/2004  
 WO 2004013419 A1 2/2004  
 WO 2006107053 A1 10/2006  
 WO 2008110221 A1 9/2008  
 WO 2008120543 A1 10/2008  
 WO 2009086947 7/2009  
 WO 2009086947 A1 7/2009  
 WO 2009086948 7/2009  
 WO 2009086948 A1 7/2009  
 WO 2010018006 2/2010  
 WO D073018-001 7/2010  
 WO 2010130645 A1 11/2010  
 WO D078587-001 1/2012  
 WO D078587-002 1/2012  
 WO D078587-003 1/2012  
 WO D078588-001 1/2012  
 WO D078588-002 1/2012  
 WO D078588-003 1/2012  
 WO D078588-003 1/2012  
 WO D079761-001 1/2012  
 WO D077855-001 3/2012  
 WO D077855-002 3/2012  
 WO 2012062914 5/2012  
 WO 2013054124 A1 4/2013  
 WO D079650-001 6/2013  
 WO D079650-002 6/2013  
 WO D079650-003 6/2013  
 WO D079650-004 6/2013  
 WO D079650-005 6/2013  
 WO D079650-006 6/2013  
 WO D079650-007 6/2013  
 WO D079650-008 6/2013  
 WO 2014029510 A1 2/2014  
 WO D082756-001 2/2014  
 WO 2015048657 A1 4/2015

OTHER PUBLICATIONS

Tesco, "Duck 5In1 Rimblock", <http://www.tesco.com/groceries/Product/Details/?id=278608564>, Oct. 8, 2013, p. 1, published 2013.  
 Myshopping.com.au, "2x Glade Perfume Toilet Block Lavender" [http://www.myshopping.com.au/ZM--1234107356\\_2x\\_glade\\_perfume\\_toilet\\_block\\_lavender](http://www.myshopping.com.au/ZM--1234107356_2x_glade_perfume_toilet_block_lavender), Oct. 8, 2013, p. 1, published 2013.

\* cited by examiner



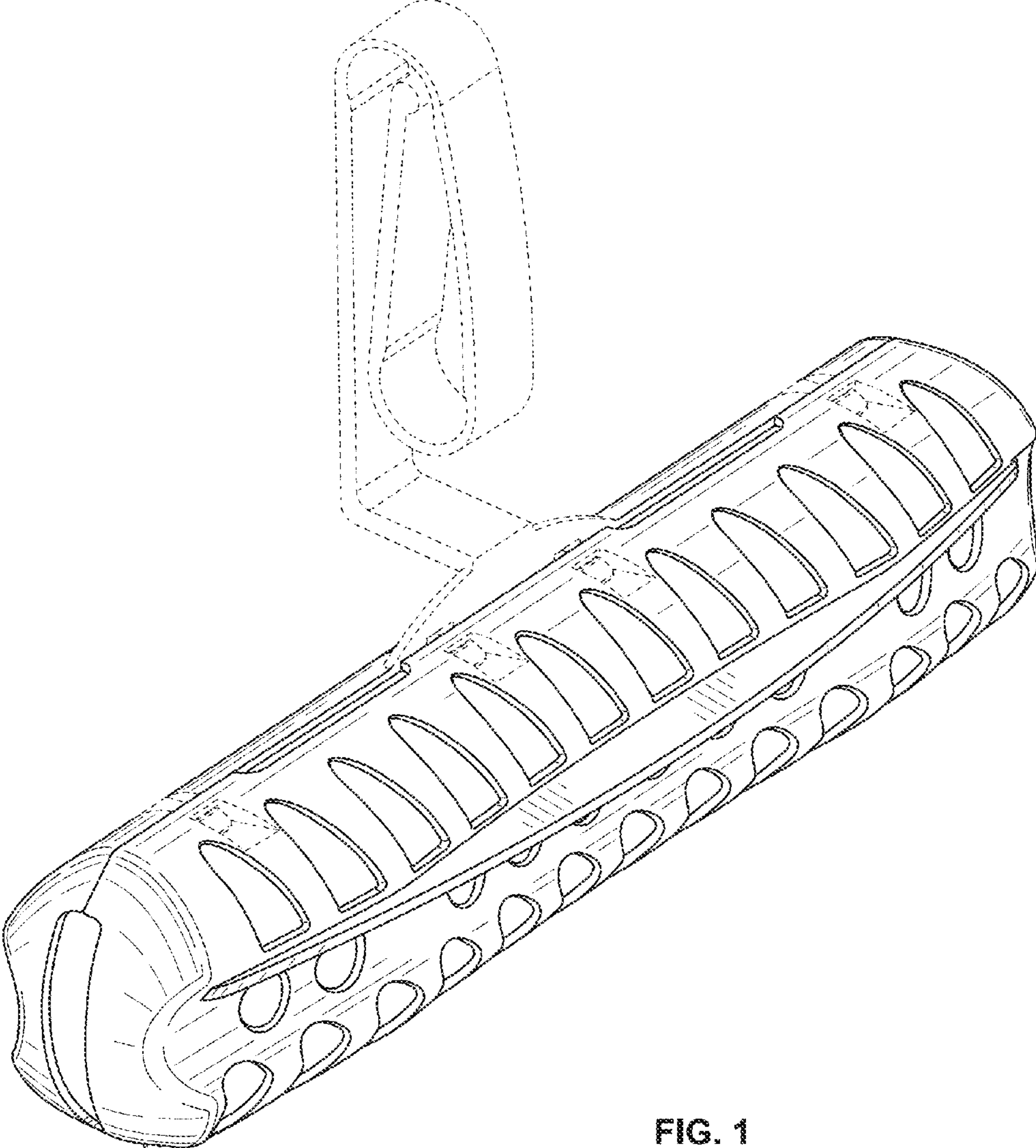

FIG. 1

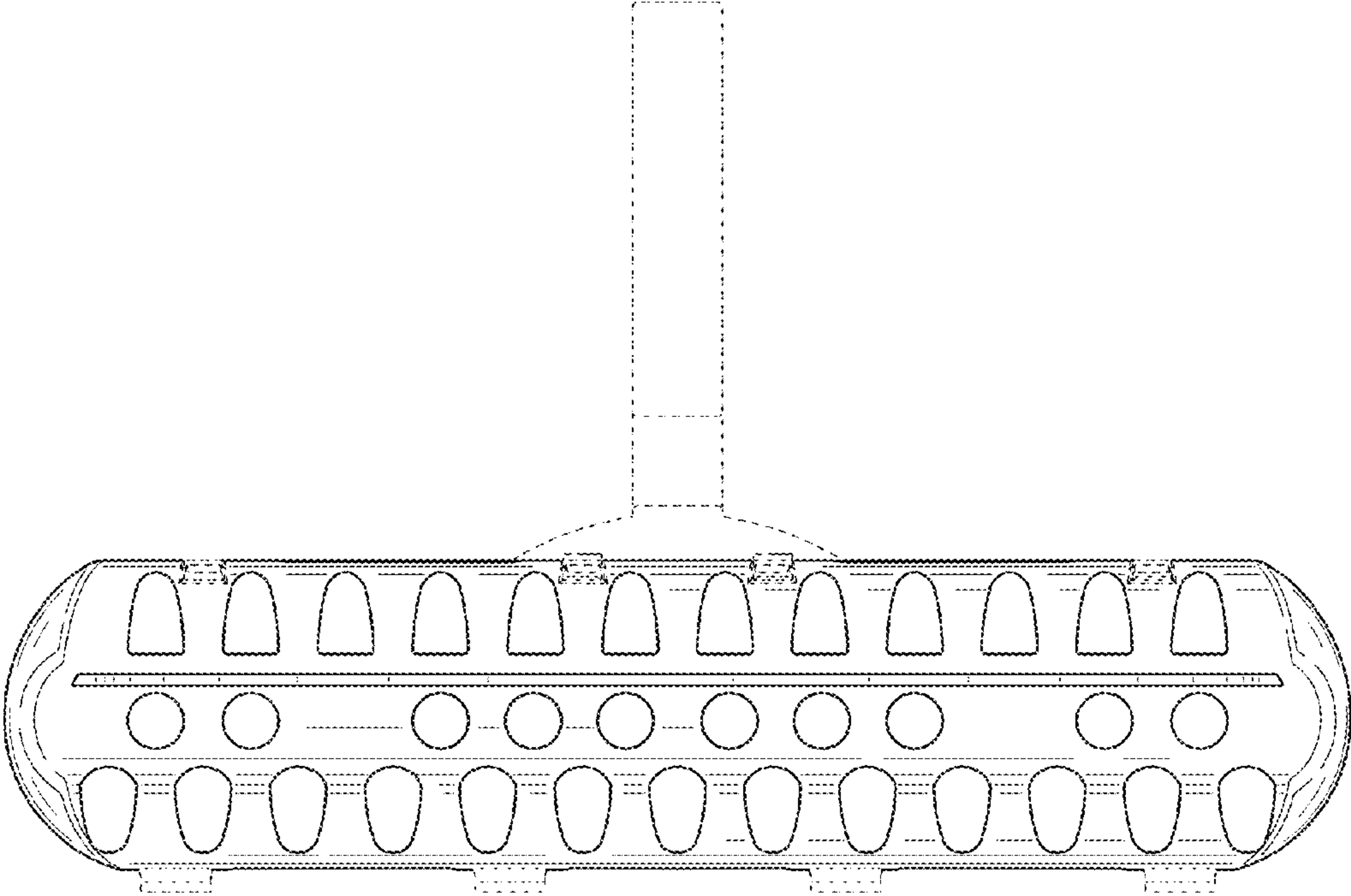

FIG. 2

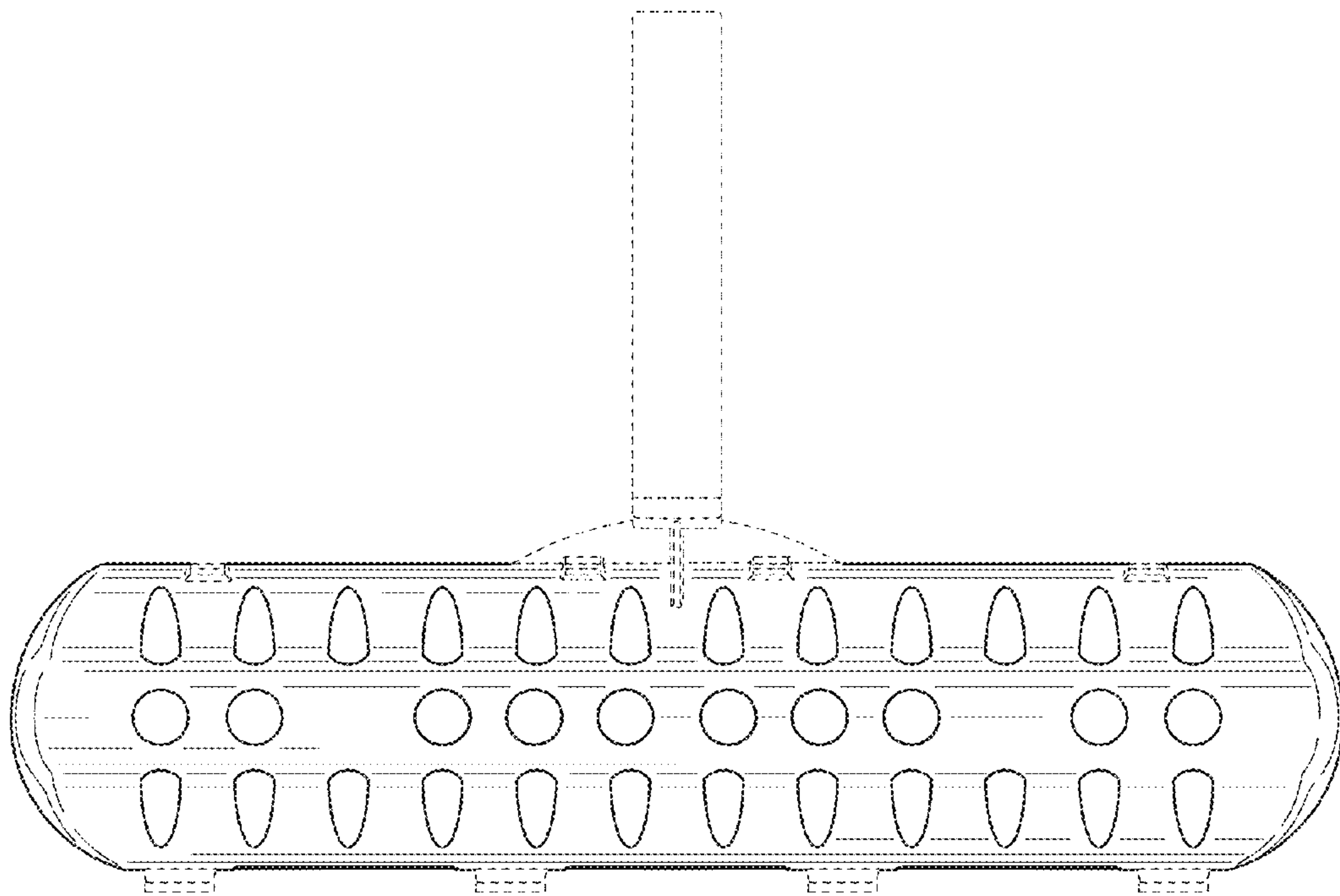

FIG. 3

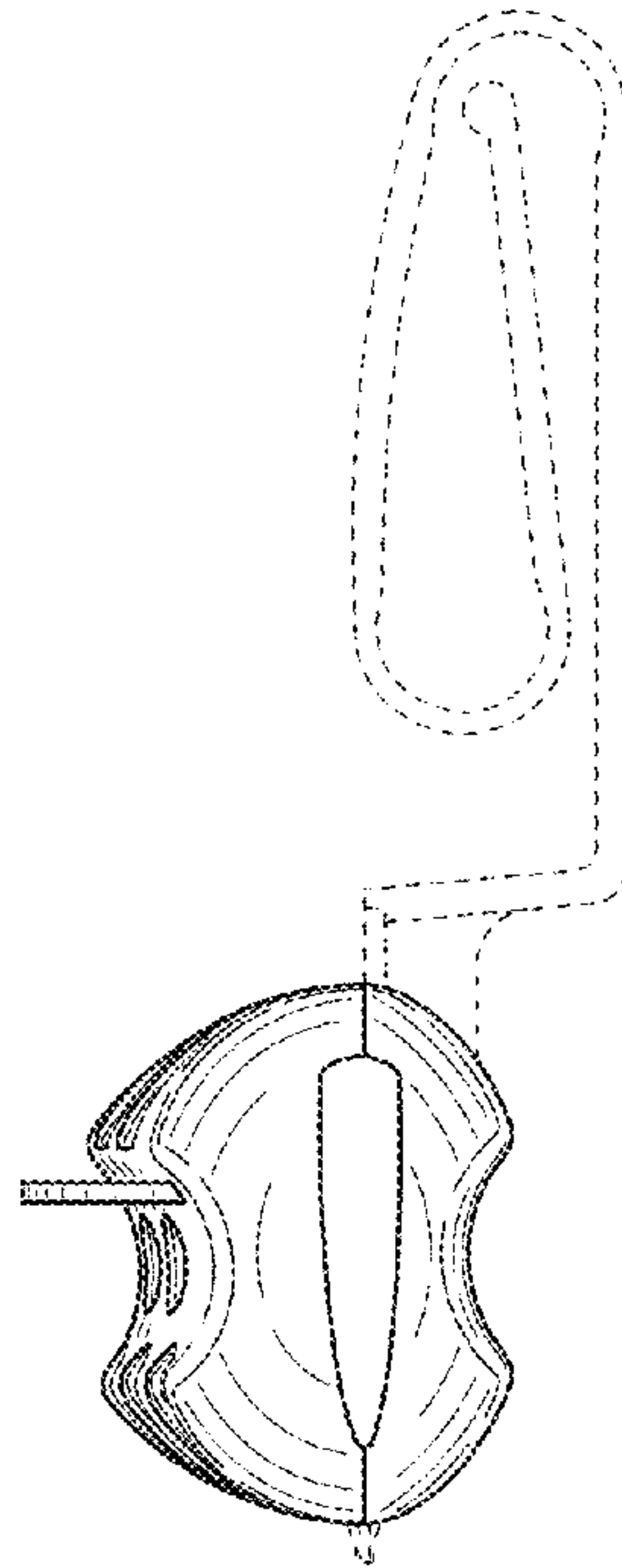

FIG. 4

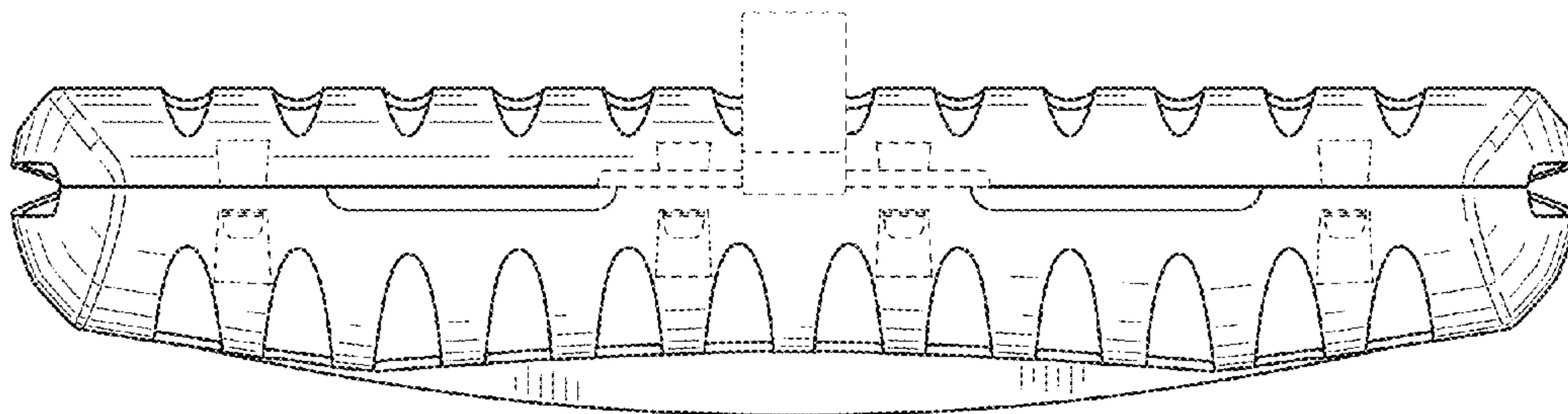

FIG. 5

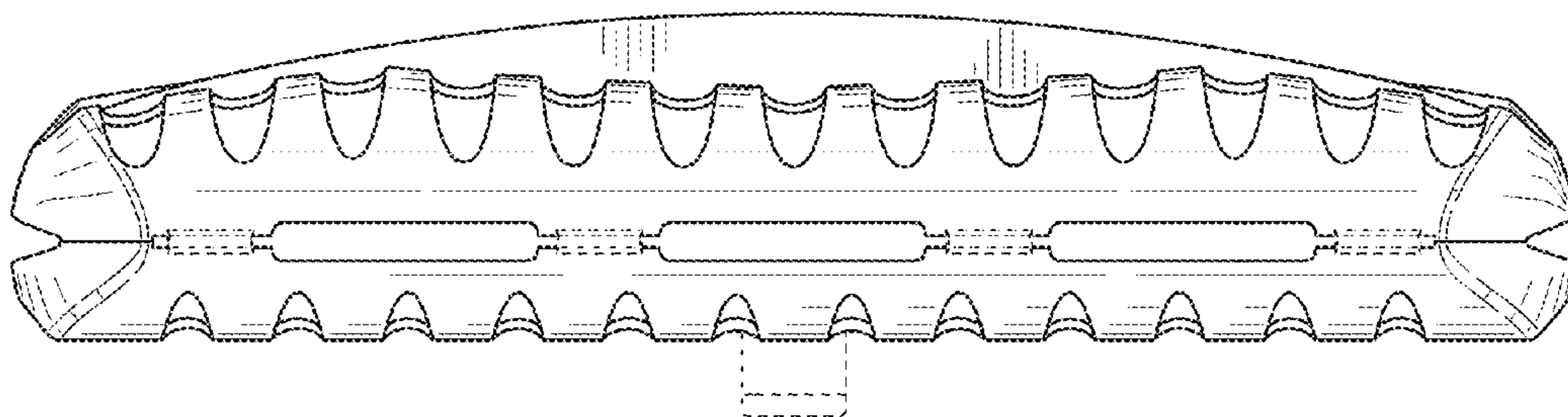

FIG. 6