

US00D752143S

(12) **United States Design Patent**  
**So et al.**

(10) **Patent No.:** **US D752,143 S**  
(45) **Date of Patent:** **\*\* \*Mar. 22, 2016**

(54) **CASE FOR A PRINTER**

(71) Applicant: **Samsung Electronics Co., Ltd.**,  
Suwon-si (KR)

(72) Inventors: **Kwang-Hyuck So**, Seoul (KR);  
**Seung-Wook Jeong**, Seoul (KR)

(73) Assignee: **Samsung Electronics Co., Ltd.**,  
Suwon-si (KR)

(\*) Notice: This patent is subject to a terminal disclaimer.

(\*\*) Term: **14 Years**

(21) Appl. No.: **29/466,185**

(22) Filed: **Sep. 5, 2013**

(30) **Foreign Application Priority Data**

Mar. 5, 2013 (KR) ..... 30-2013-0011094

(51) **LOC (10) Cl.** ..... **14-02**

(52) **U.S. Cl.**  
USPC ..... **D18/55**

(58) **Field of Classification Search**  
USPC ..... D18/36-37, 50, 54, 54.1, 55;  
D14/420-425, 462-470; 400/613,  
400/613.1-613.4, 690.1-690.4, 691-694  
See application file for complete search history.

(56) **References Cited**

U.S. PATENT DOCUMENTS

D236,835	S	*	9/1975	Kramer et al.	.....	D18/54
D270,732	S	*	9/1983	Brown et al.	.....	D18/54
7,366,459	B2	*	4/2008	Nishimura	.....	399/392
D660,908	S	*	5/2012	Leman et al.	.....	D18/55
D681,107	S	*	4/2013	Larson et al.	.....	D18/50

\* cited by examiner

*Primary Examiner* — Cathy Anne MacCormac

(74) *Attorney, Agent, or Firm* — NSIP Law

(57) **CLAIM**

The ornamental design for a case for a printer, as shown and described.

**DESCRIPTION**

FIG. 1 is a front perspective view of a case for a printer showing our new design;

FIG. 2 is a front view thereof;

FIG. 3 is a rear view thereof;

FIG. 4 is a left-side view thereof;

FIG. 5 is a right-side view thereof;

FIG. 6 is a top view thereof; and,

FIG. 7 is a bottom view thereof.

The broken lines depict environmental subject matter, are for illustration only and form no part of the claimed design.

**1 Claim, 5 Drawing Sheets**

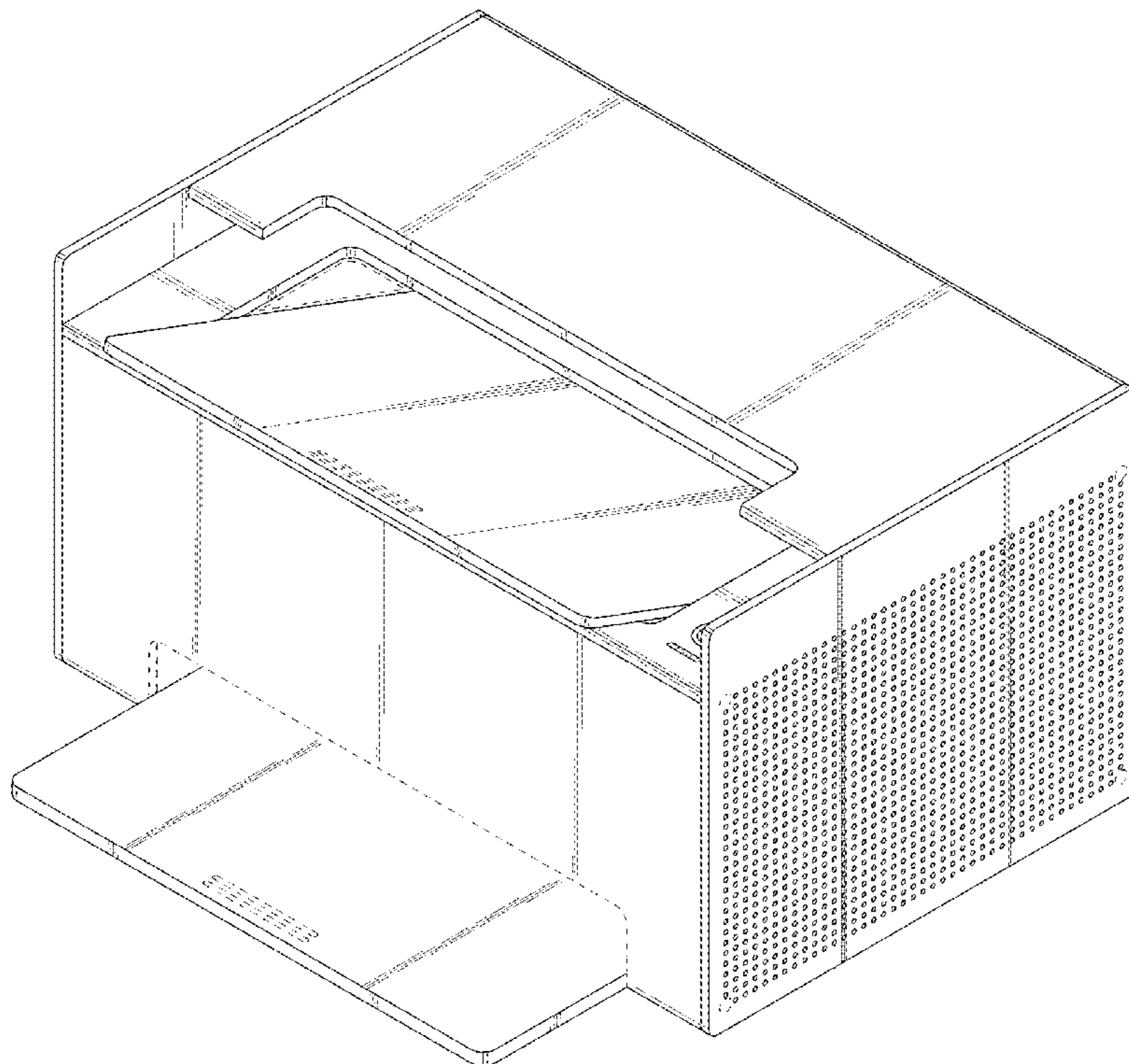

FIG.1

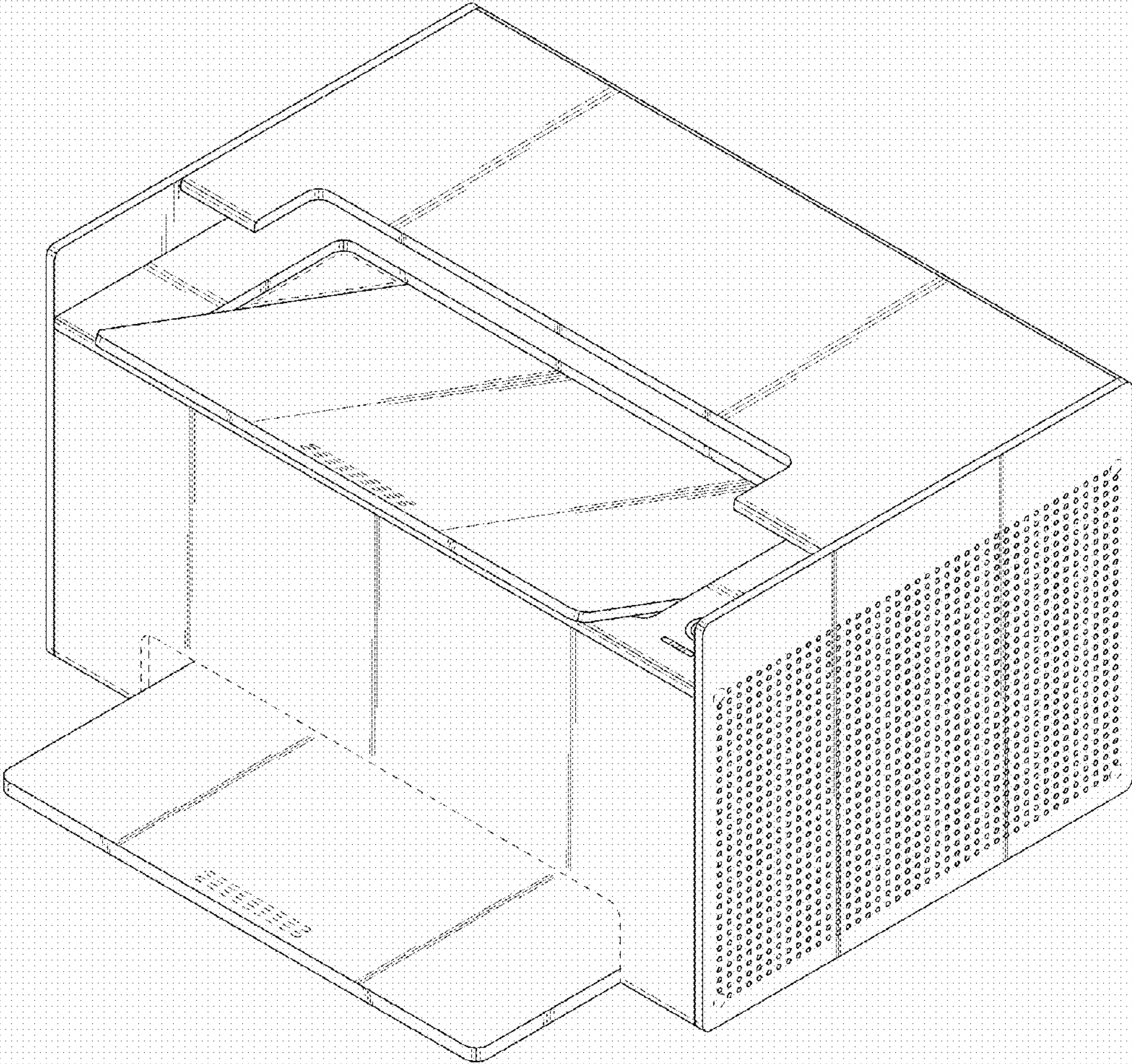

FIG.2

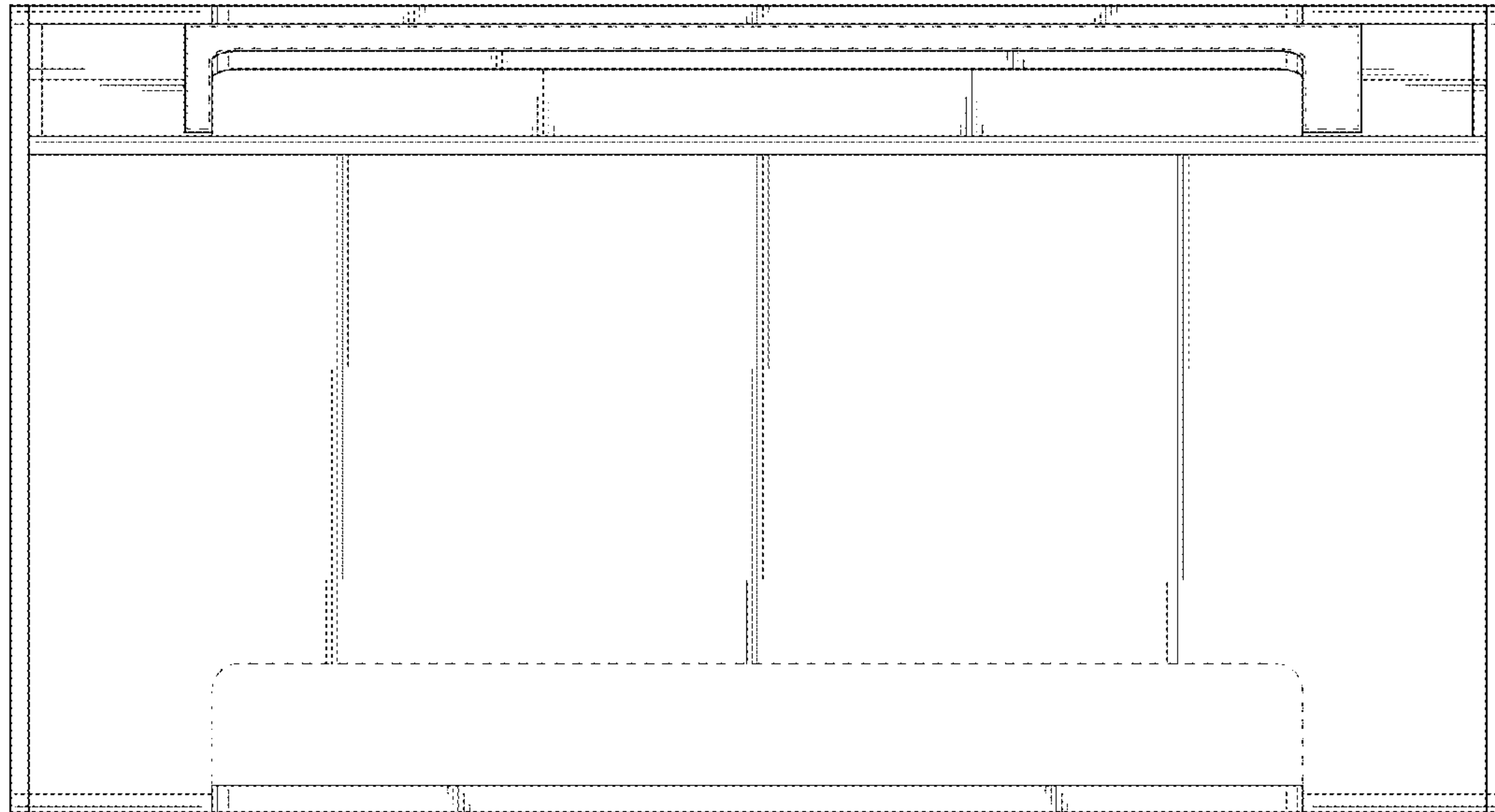

FIG.3

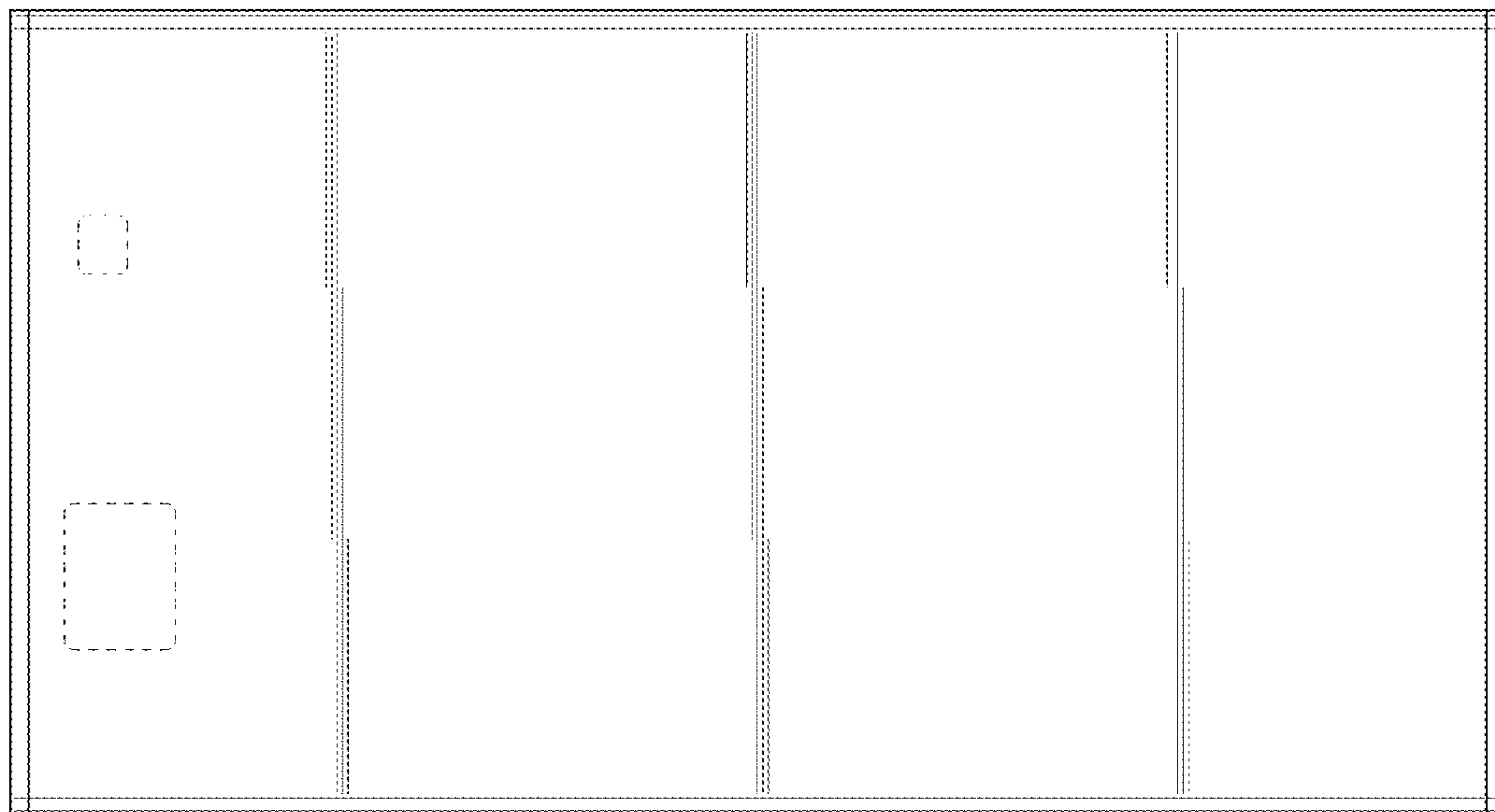



FIG.4

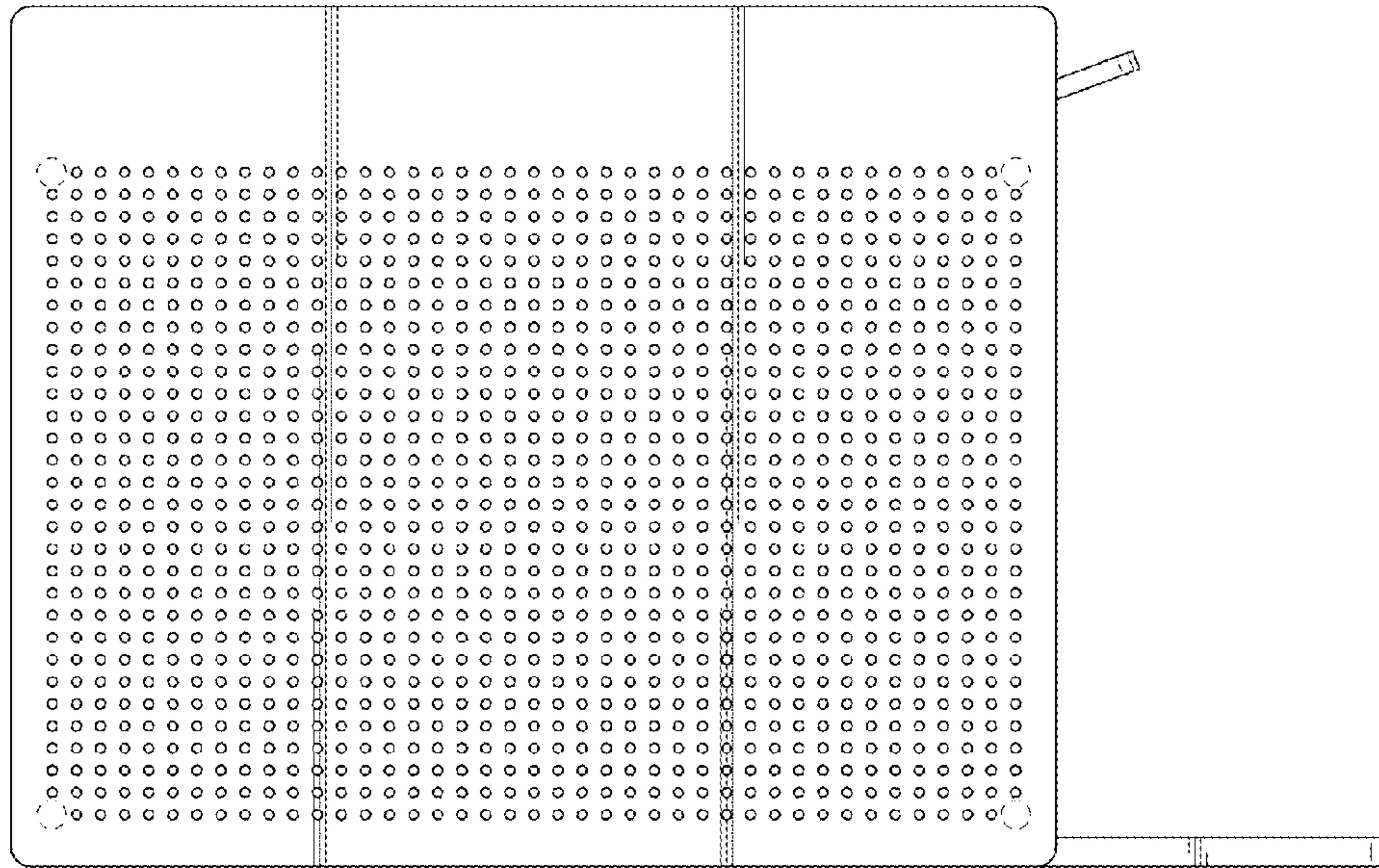

FIG.5

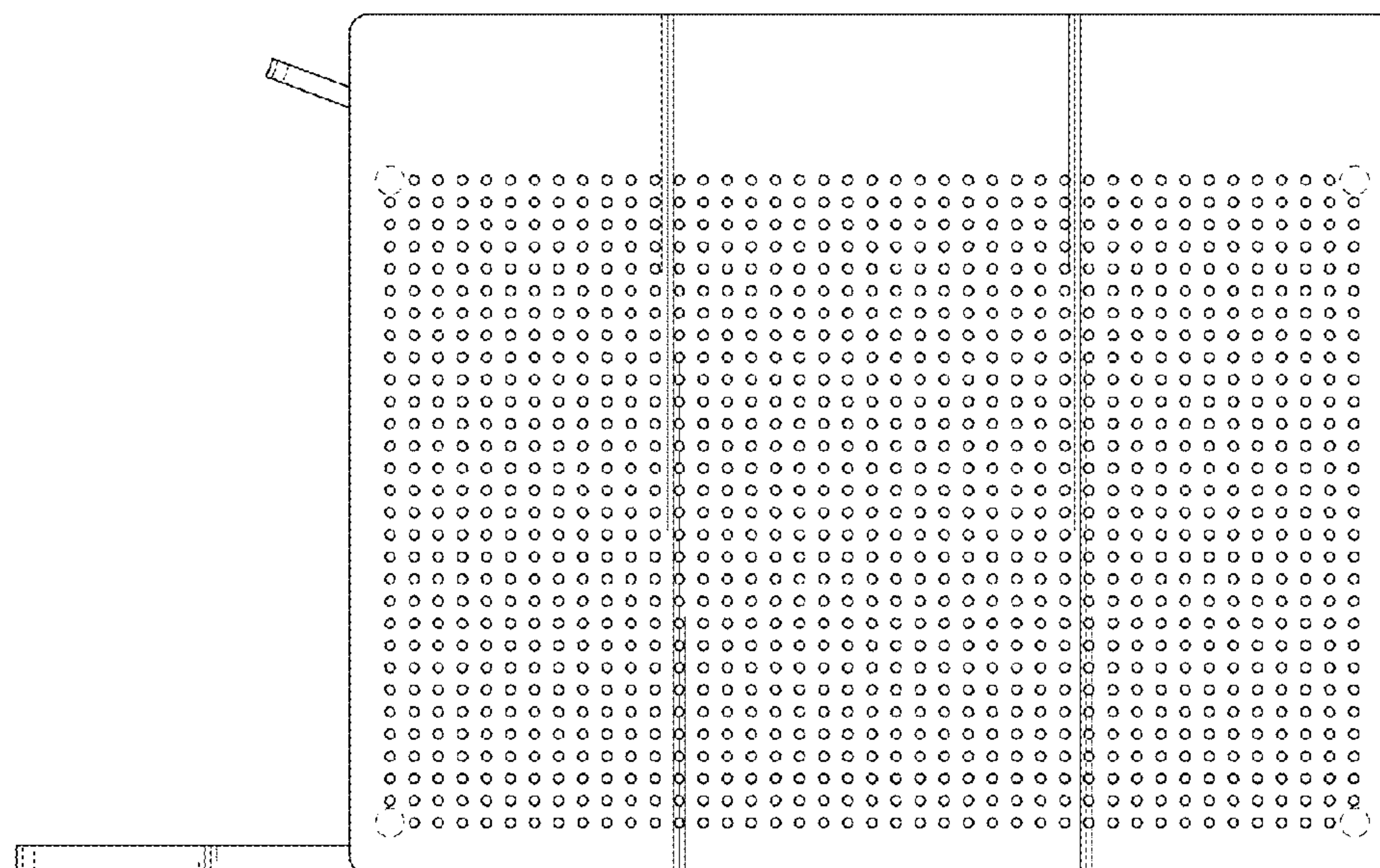

FIG.6

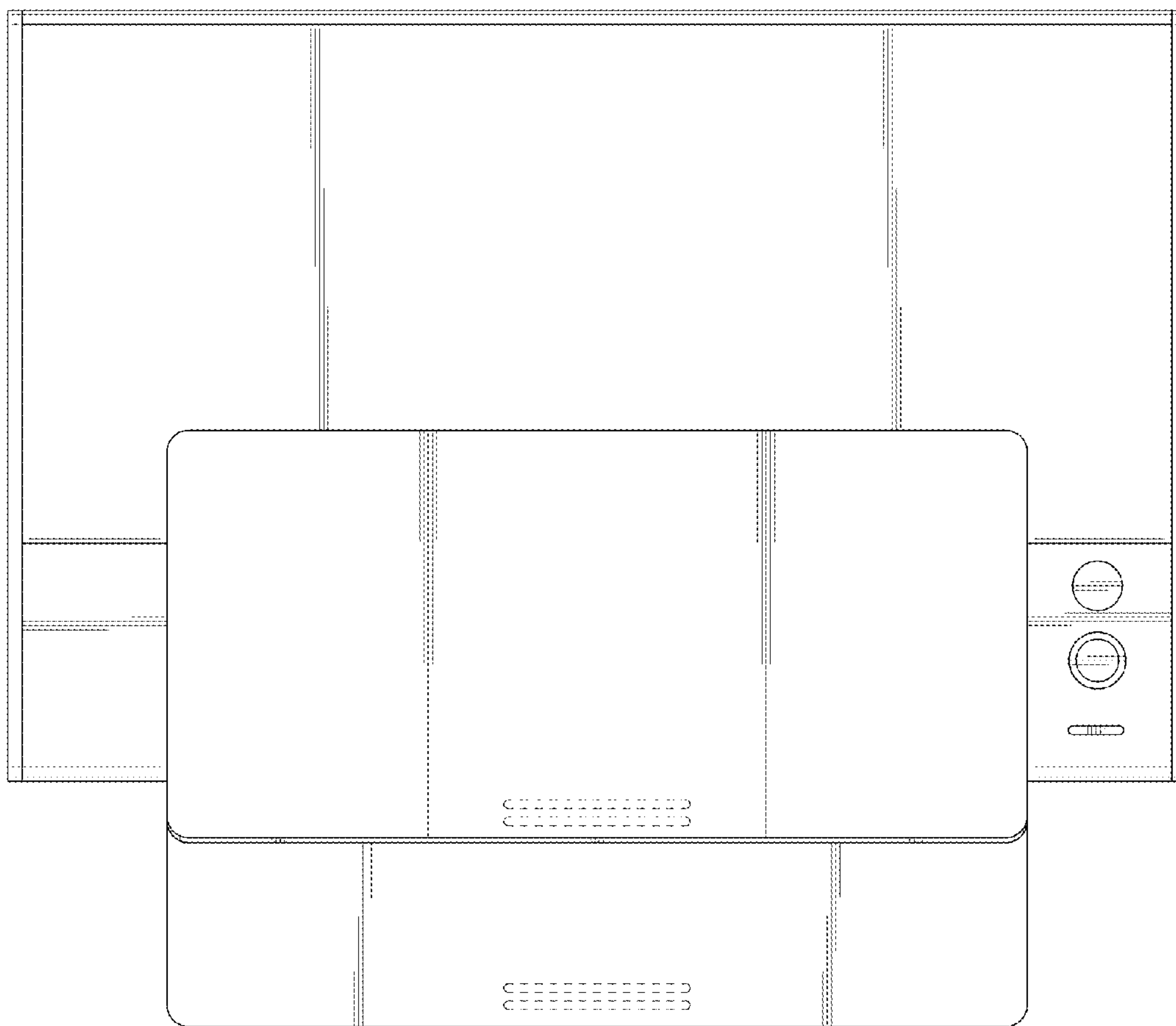

FIG.7

