



US00D752138S

(12) **United States Design Patent**  
**Seki et al.**

(10) **Patent No.:** **US D752,138 S**  
(45) **Date of Patent:** **\*\* Mar. 22, 2016**

- (54) **PRINTER**
- (71) Applicants: **Yusaku Seki**, Nagoya (JP); **Yukihiko Sato**, Nagoya (JP); **Toshiya Inada**, Nagoya (JP)
- (72) Inventors: **Yusaku Seki**, Nagoya (JP); **Yukihiko Sato**, Nagoya (JP); **Toshiya Inada**, Nagoya (JP)
- (73) Assignee: **BROTHER INDUSTRIES, LTD.**, Nagoya (JP)

D645,896 S	9/2011	Iwai et al.	
D648,377 S	11/2011	Miyauchi et al.	
D648,379 S	11/2011	Ishikawa et al.	
D667,050 S	9/2012	Takeuchi	
D667,051 S	9/2012	Sato	
D669,082 S	10/2012	Sato	
D675,673 S	2/2013	Sato	
D675,674 S	2/2013	Sato	
D675,675 S *	2/2013	Sato et al.	..... D18/50
D678,402 S	3/2013	Sato	
D681,720 S	5/2013	Inada	
D722,109 S *	2/2015	Nanno et al.	..... D18/50
2014/0139986 A1 *	5/2014	Osakabe et al.	..... 361/679.01

(\*\*) Term: **14 Years**

(21) Appl. No.: **29/484,000**

(22) Filed: **Mar. 5, 2014**

(30) **Foreign Application Priority Data**

Sep. 5, 2013 (JP) ..... 2013-020507

(51) **LOC (10) Cl.** ..... **14-02**

(52) **U.S. Cl.**  
USPC ..... **D18/50**

(58) **Field of Classification Search**  
USPC ..... D18/50, 54, 54.1, 55; D14/420-426,  
D14/462-470; 400/613, 613.1-613.4,  
400/690.1-690.4, 691-694  
See application file for complete search history.

(56) **References Cited**

U.S. PATENT DOCUMENTS

D558,823 S *	1/2008	Alfonso et al.	..... D18/55
D607,925 S	1/2010	Morrison et al.	
D613,791 S *	4/2010	Yoshioka et al.	..... D18/55
D614,234 S	4/2010	Ishikawa et al.	
D643,462 S	8/2011	Yamashita et al.	

OTHER PUBLICATIONS

Design U.S. Appl. No. 29/467,373, filed Sep. 18, 2013 in the name of Seki et al.  
Oct. 14, 2014 Office Action issued in Design U.S. Appl. No. 29/467,373.

\* cited by examiner

*Primary Examiner* — Cathy Anne MacCormac  
(74) *Attorney, Agent, or Firm* — Oliff PLC

(57) **CLAIM**

The ornamental design for a printer, as shown and described.

**DESCRIPTION**

FIG. 1 is a perspective view of a printer;  
FIG. 2 is a front view thereof;  
FIG. 3 is a top view thereof;  
FIG. 4 is a right-side view thereof;  
FIG. 5 is a left-side view thereof;  
FIG. 6 is a rear view thereof; and,  
FIG. 7 is a bottom view thereof.  
The broken lines depict environmental subject matter only and form no part of the claimed design.

**1 Claim, 6 Drawing Sheets**

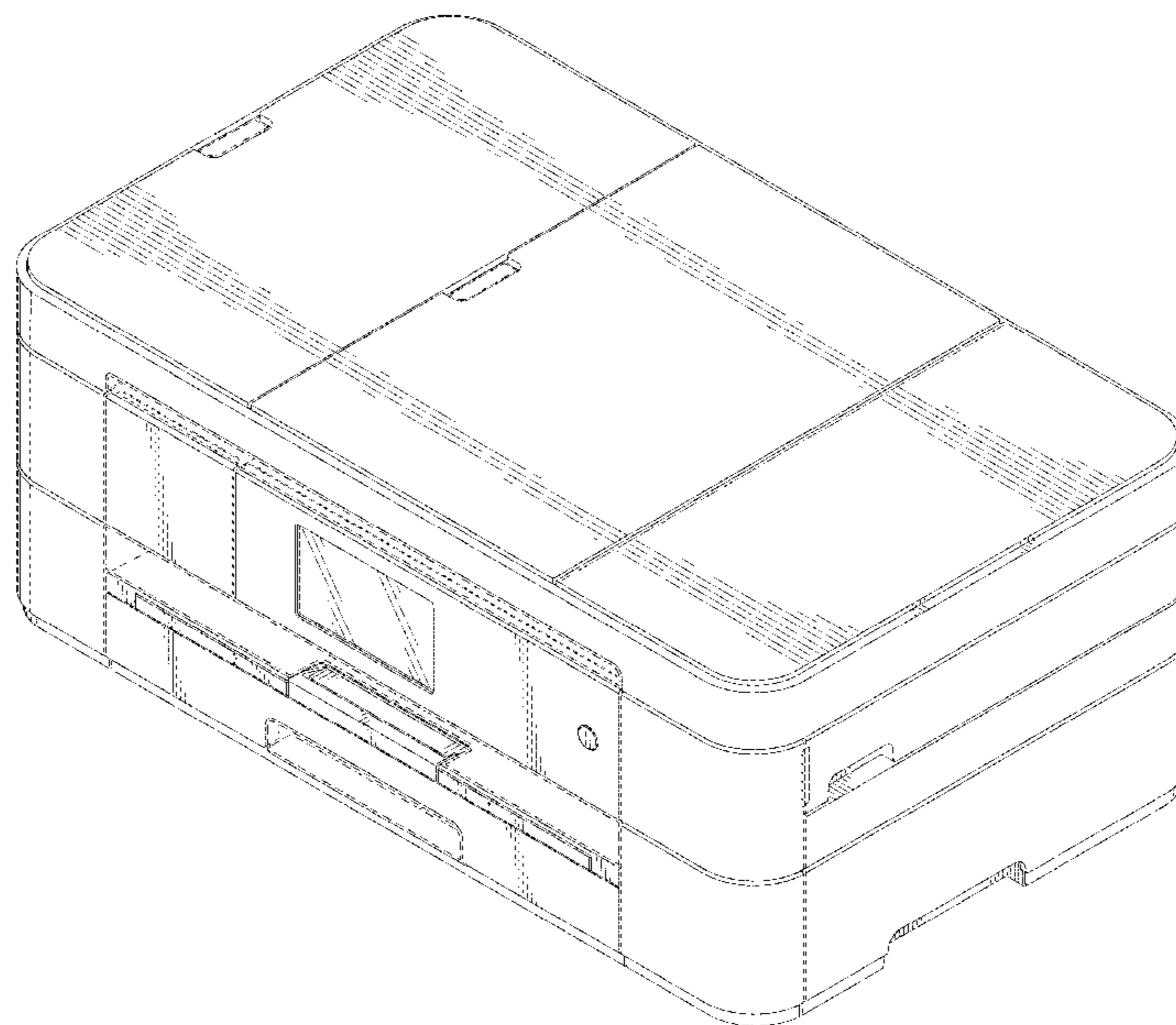

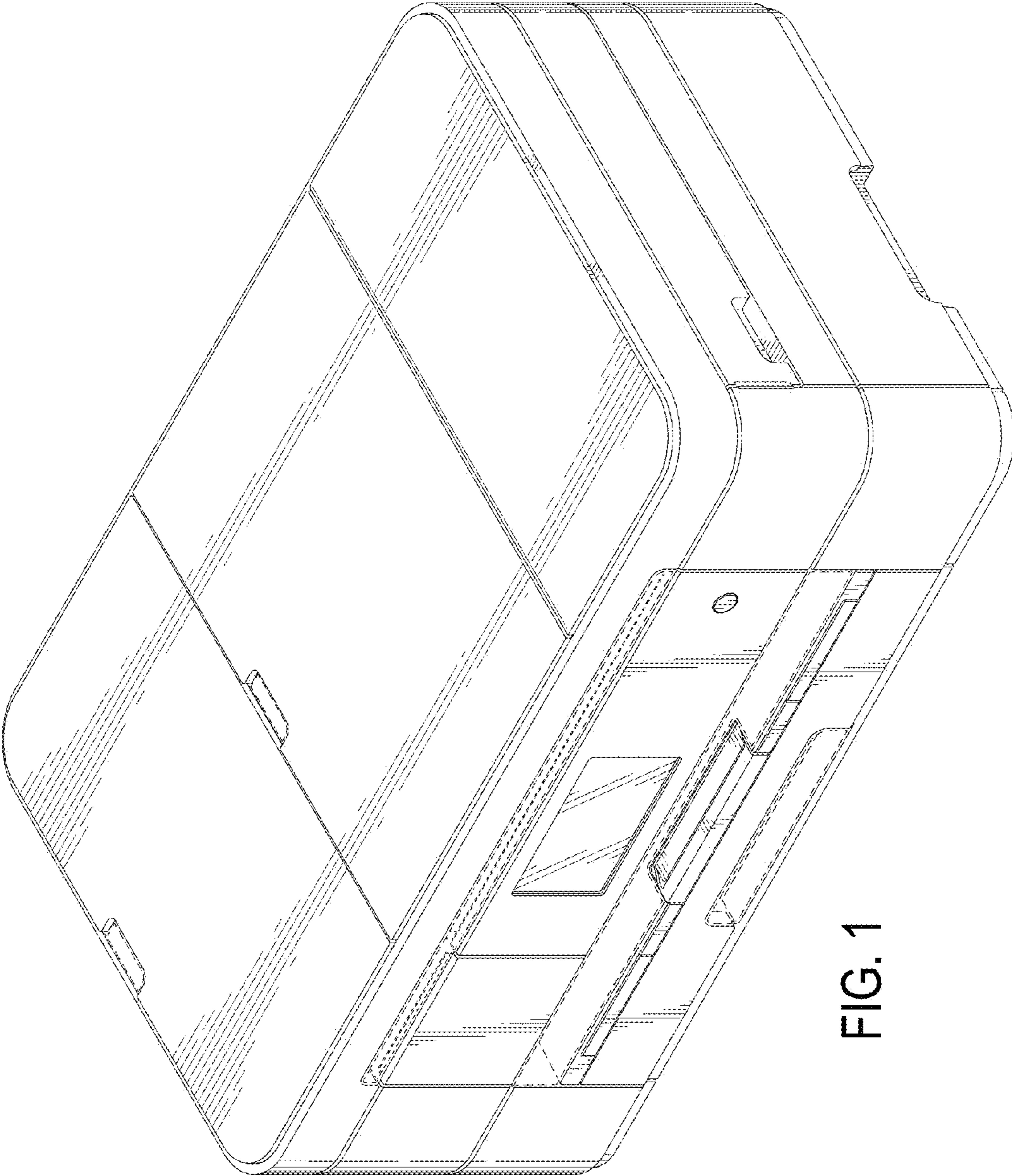

FIG. 1

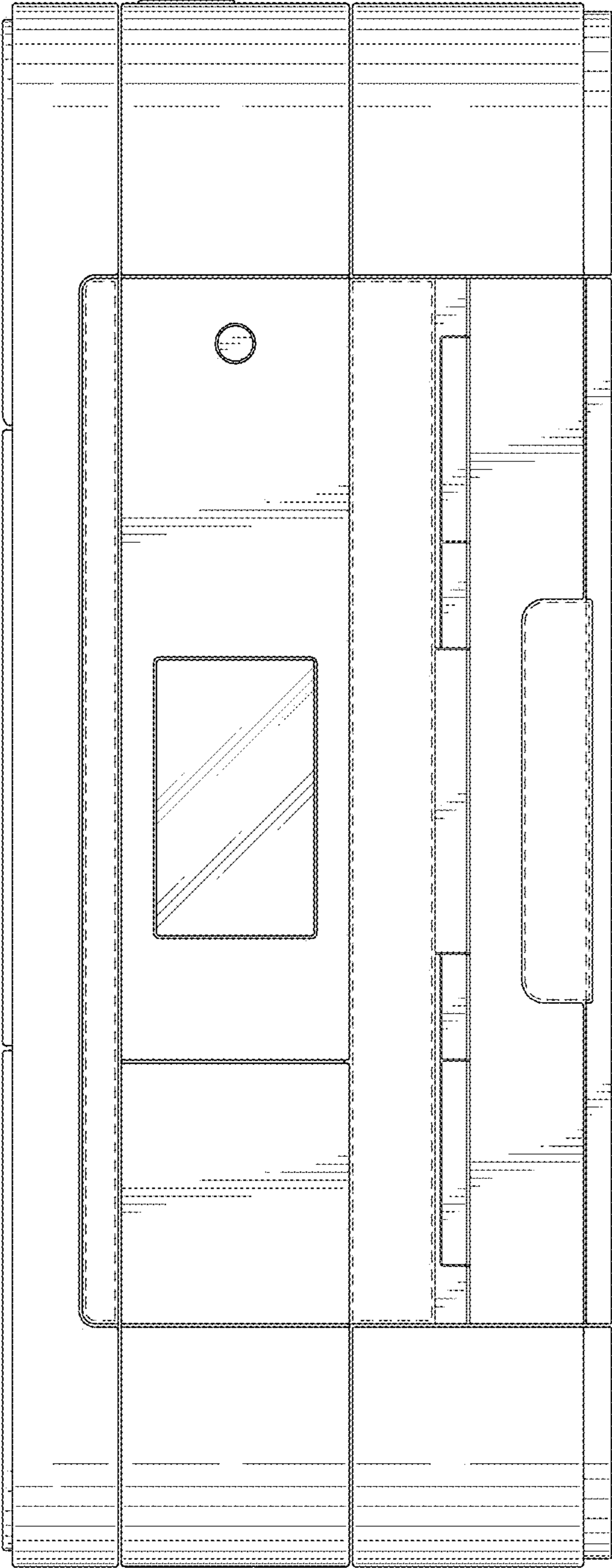

FIG. 2

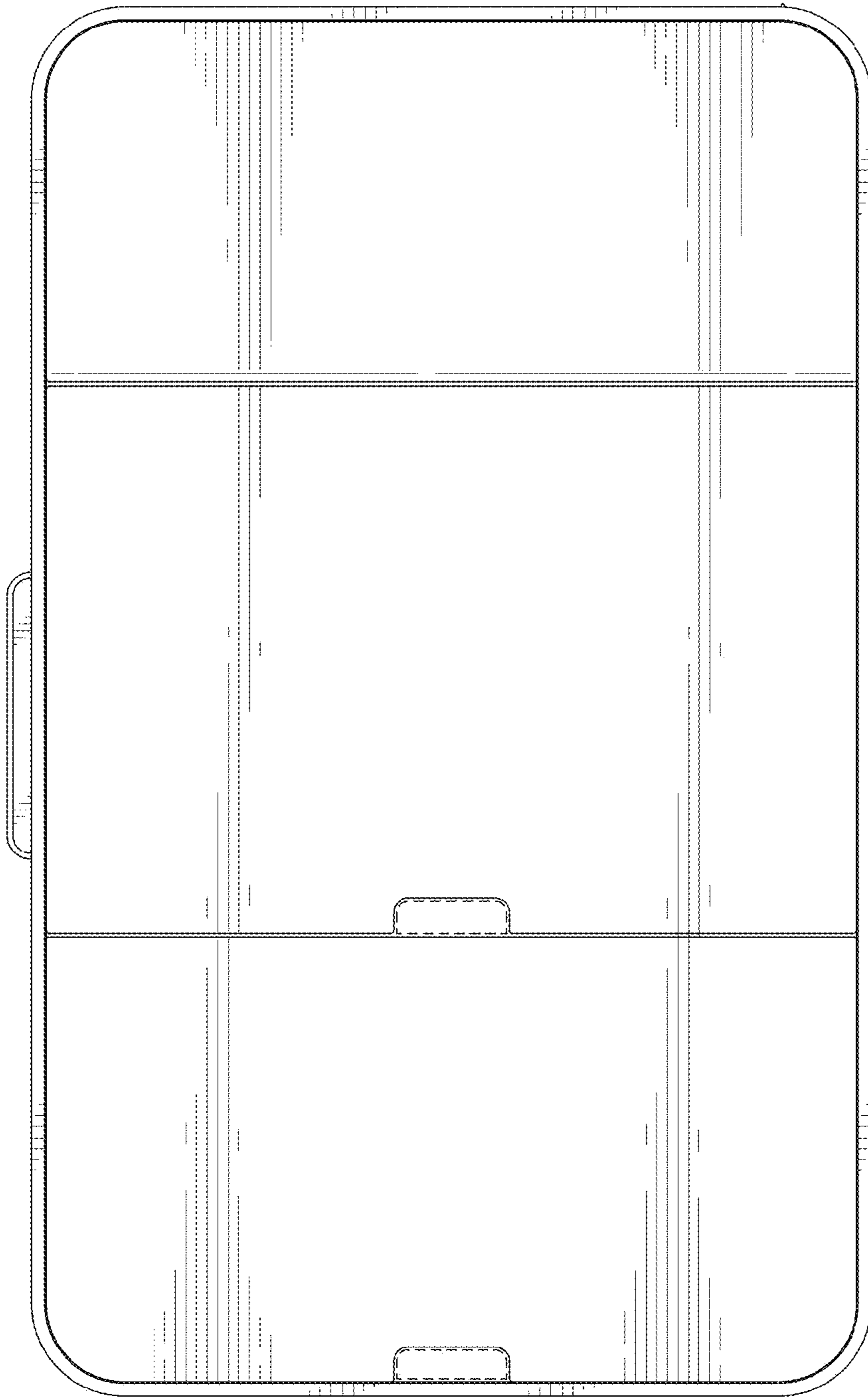

FIG. 3

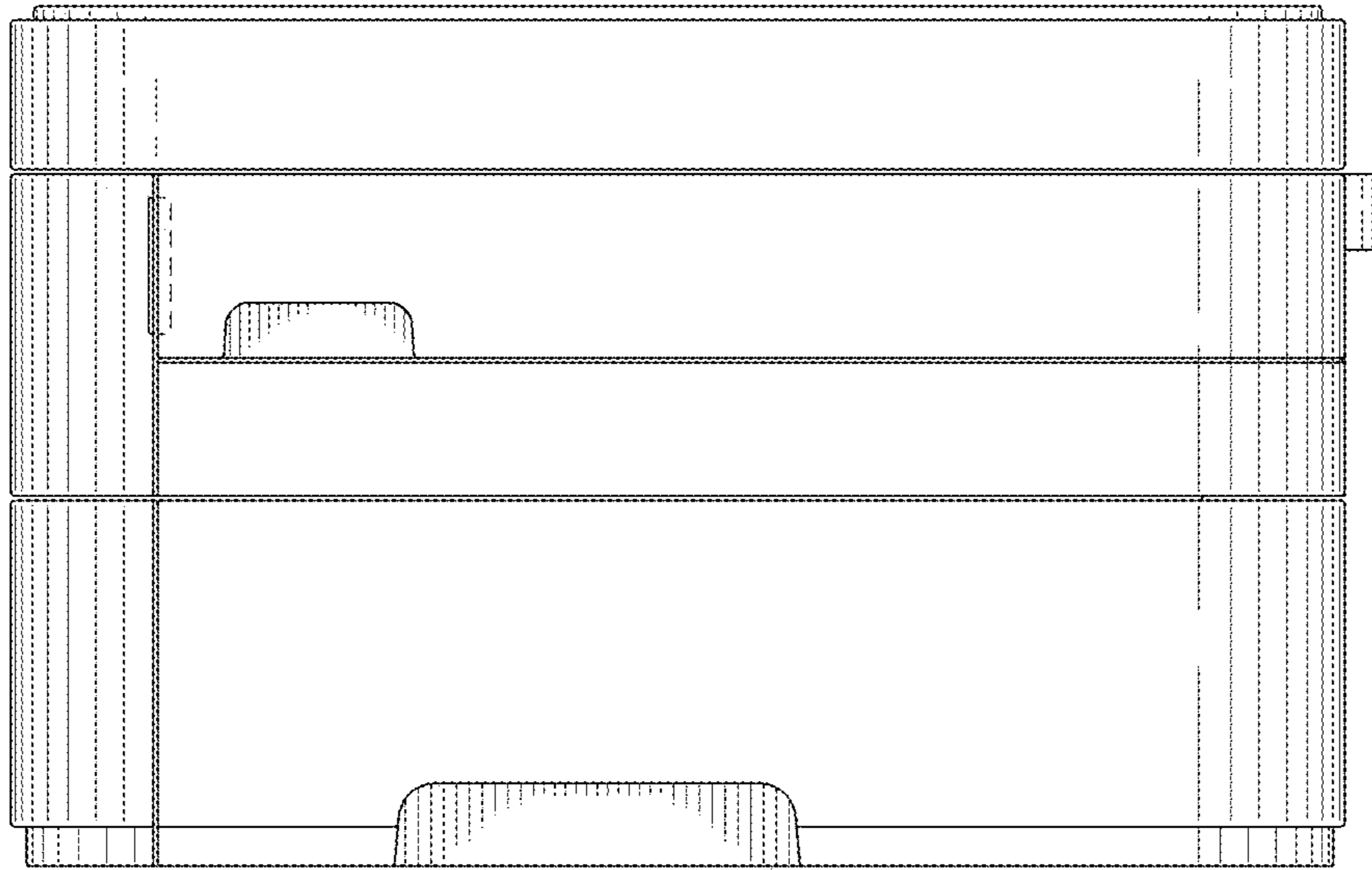

FIG. 4

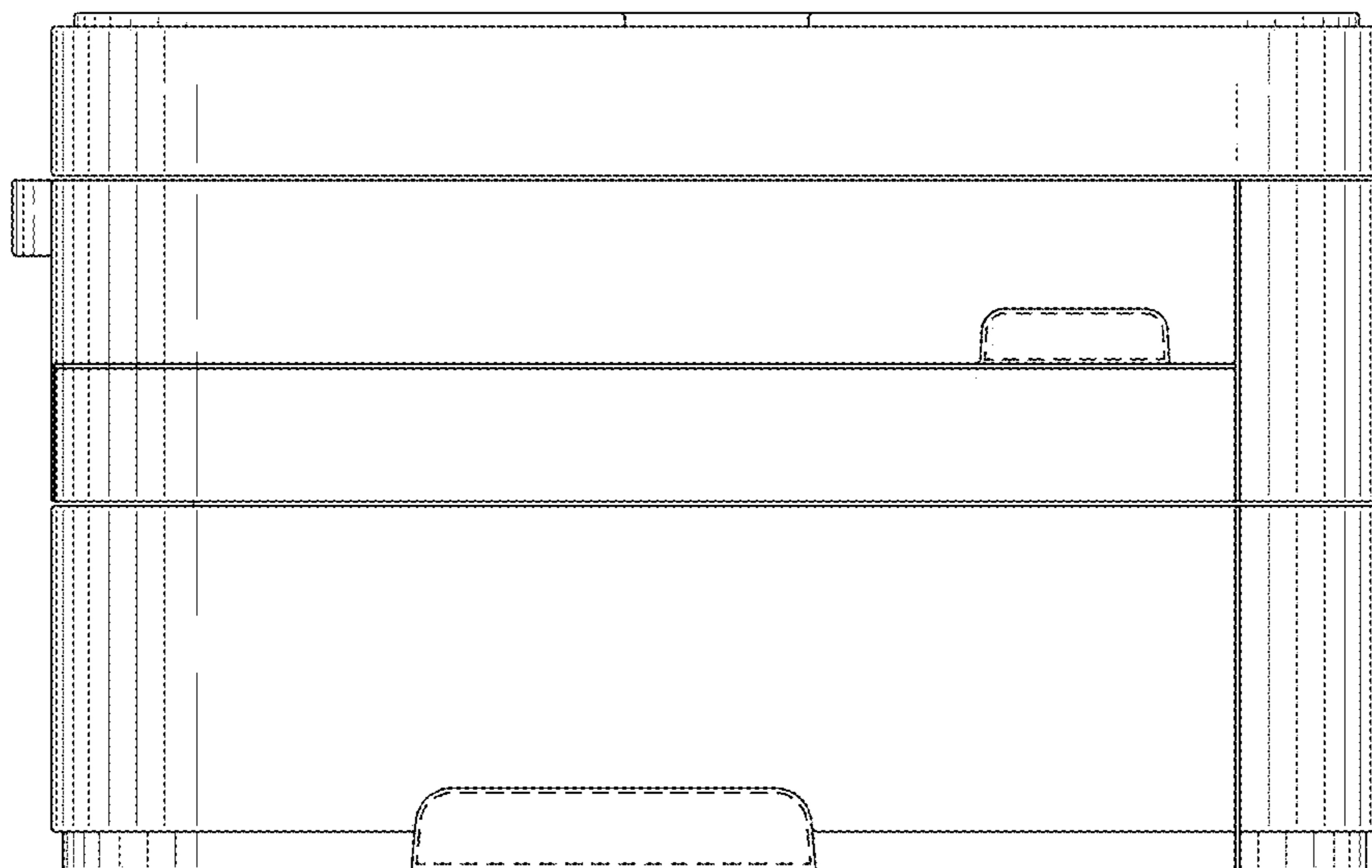

FIG. 5

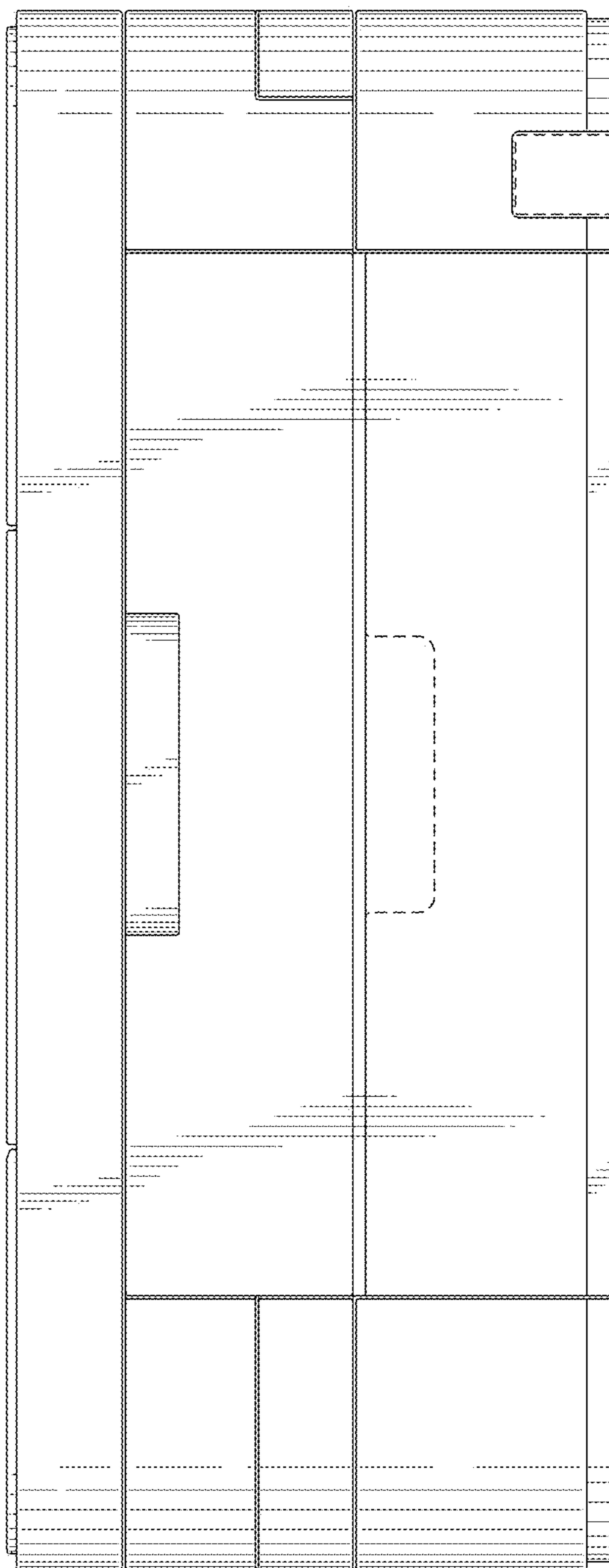

FIG. 6

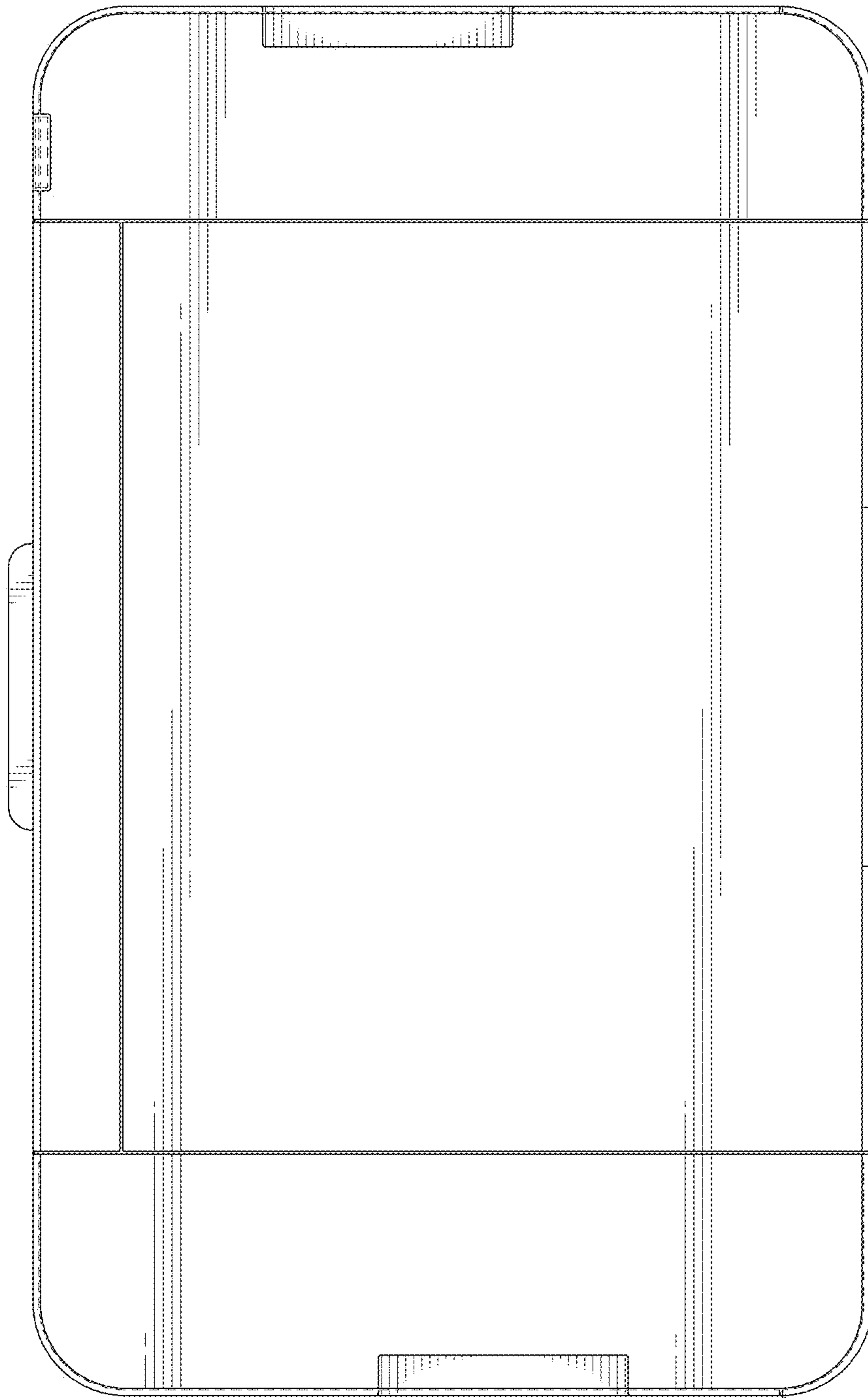

FIG. 7