



US00D751994S

(12) **United States Design Patent**
Stewart

(10) **Patent No.:** **US D751,994 S**
(45) **Date of Patent:** **** Mar. 22, 2016**

- (54) **FACETED CONNECTOR COVER**
- (71) Applicant: **Brittany L. Stewart**, Nashville, TN (US)
- (72) Inventor: **Brittany L. Stewart**, Nashville, TN (US)
- (73) Assignee: **Griffin Technology, Inc.**, Nashville, TN (US)
- (**) Term: **14 Years**
- (21) Appl. No.: **29/498,102**
- (22) Filed: **Jul. 31, 2014**
- (51) **LOC (10) Cl.** **13-03**
- (52) **U.S. Cl.**
USPC **D13/156**
- (58) **Field of Classification Search**
USPC D13/133, 149, 150, 153, 154, 156, 184, D13/199
See application file for complete search history.

- 2003/0081916 A1* 5/2003 Norris G02B 6/4465 385/100
- 2010/0216324 A1* 8/2010 Lust H01R 13/5213 439/135
- 2011/0188813 A1* 8/2011 Marcouiller G02B 6/3849 385/78
- 2015/0063759 A1* 3/2015 Barnette, Jr. G02B 6/3849 385/78

* cited by examiner

Primary Examiner — Daniel Bui

(74) *Attorney, Agent, or Firm* — Hornkohl Intellectual Property Law, PLLC; Jason L. Hornkohl

(57) **CLAIM**

The ornamental design for a faceted connector cover, as shown and described.

DESCRIPTION

FIG. 1 is a top, front and left side perspective view of a connector cover in use condition, showing my new design; FIG. 2 is a top, front and left side perspective view thereof; FIG. 3 is a bottom, rear and left side perspective view thereof; FIG. 4 is a top plan view thereof; FIG. 5 is a left side elevation view thereof. The right side elevation view is a mirror image of the left side; FIG. 6 is a back elevation view thereof; FIG. 7 is a front elevation view thereof; and, FIG. 8 is a bottom plan view thereof.

The broken line in the figure drawing views is included for the purpose of illustrating unclaimed environment and forms no part of the claimed design.

1 Claim, 2 Drawing Sheets

(56) **References Cited**

U.S. PATENT DOCUMENTS

- D256,010 S * 7/1980 Fry D13/156
- D319,217 S * 8/1991 Fujioka D13/156
- D698,627 S * 2/2014 Chance D13/156
- D710,311 S * 8/2014 Chance D13/156

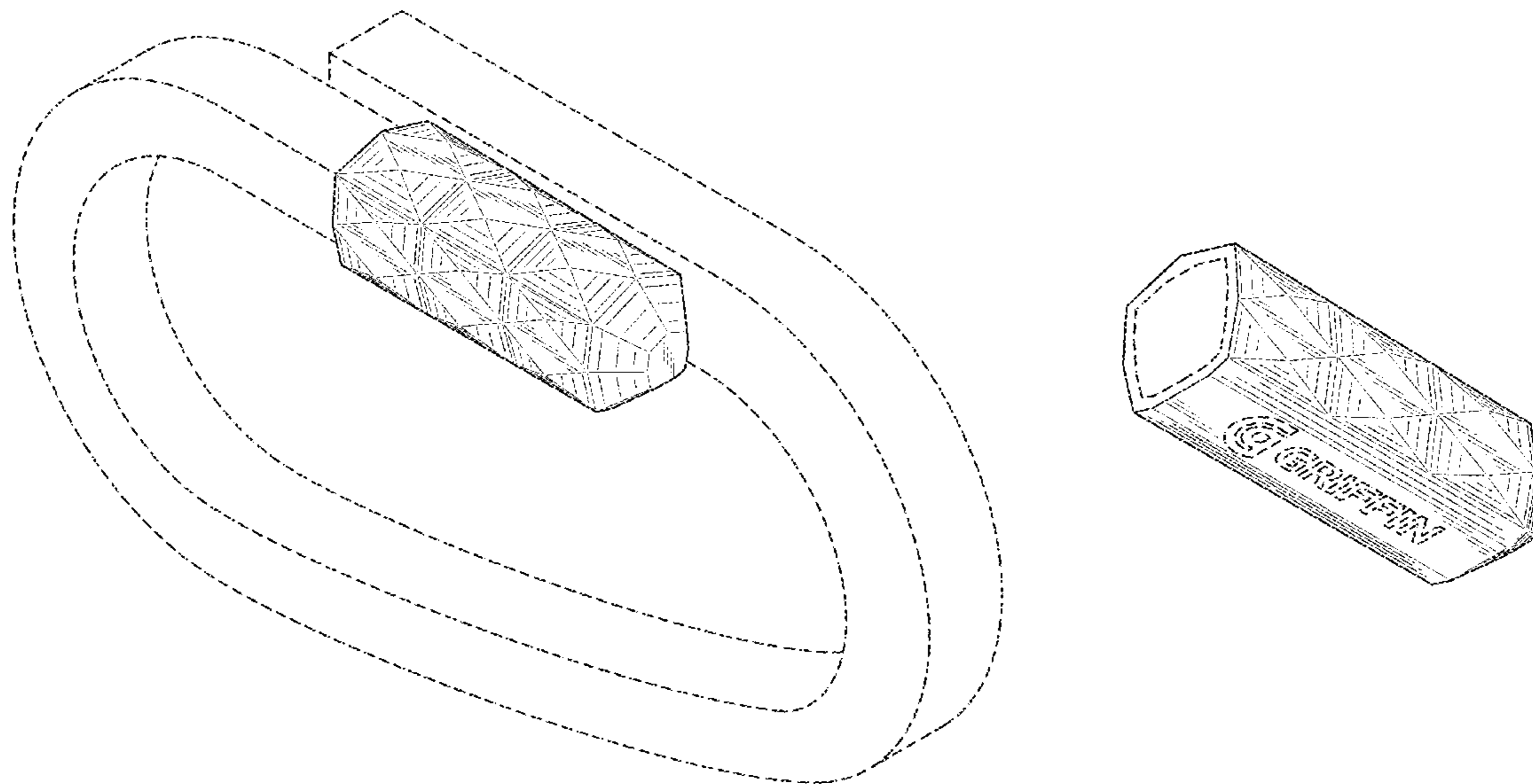

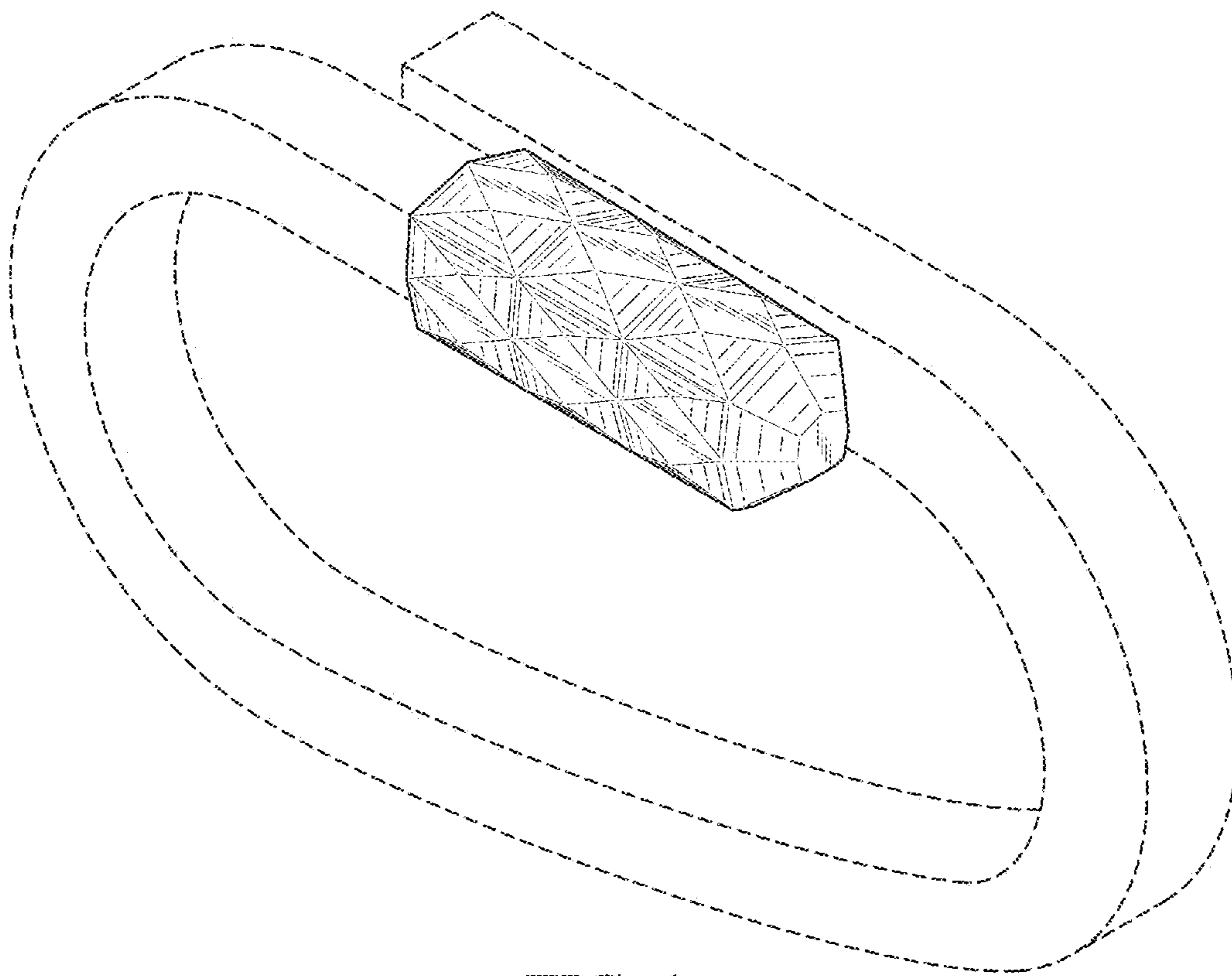

FIG. 1

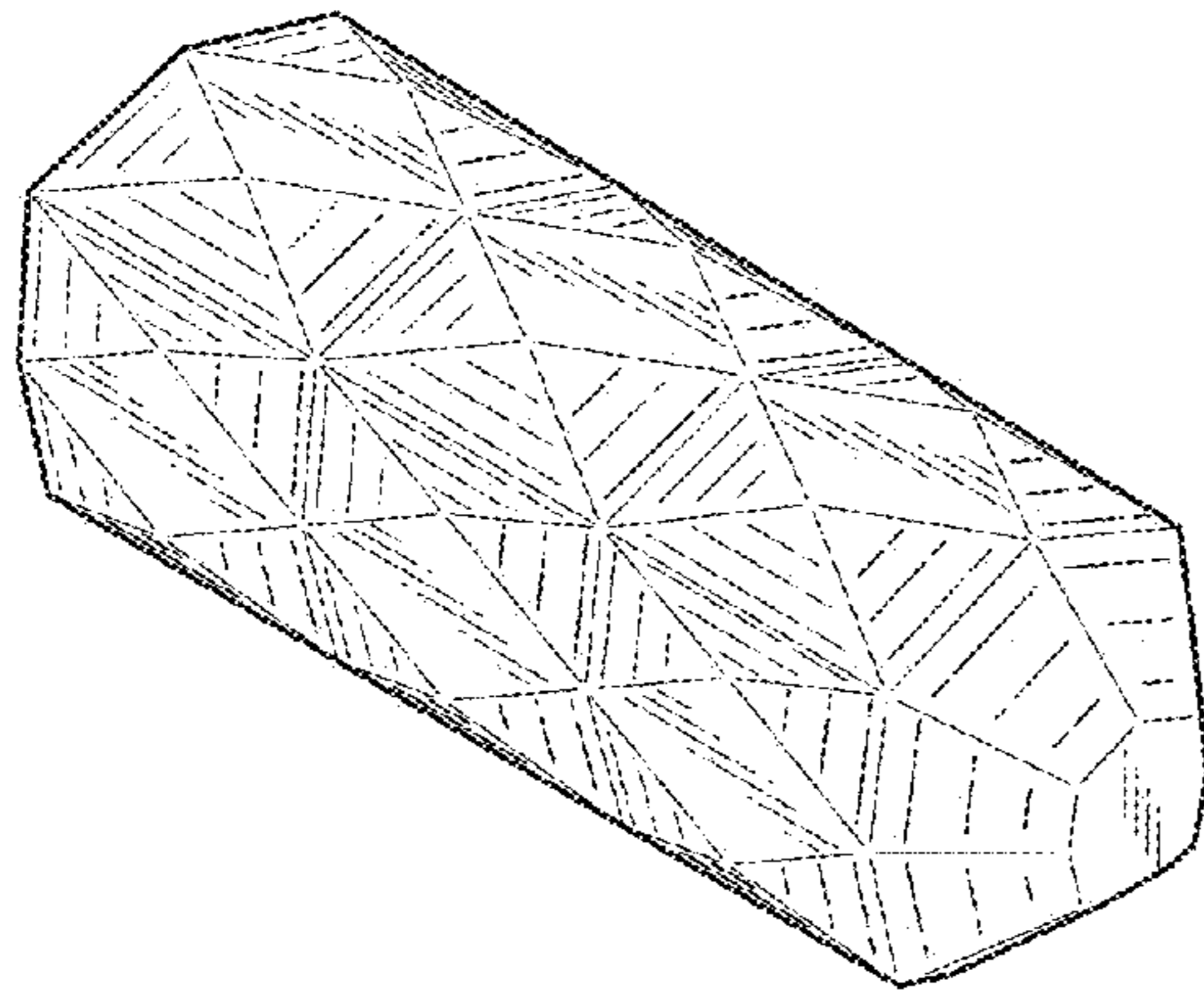

FIG. 2

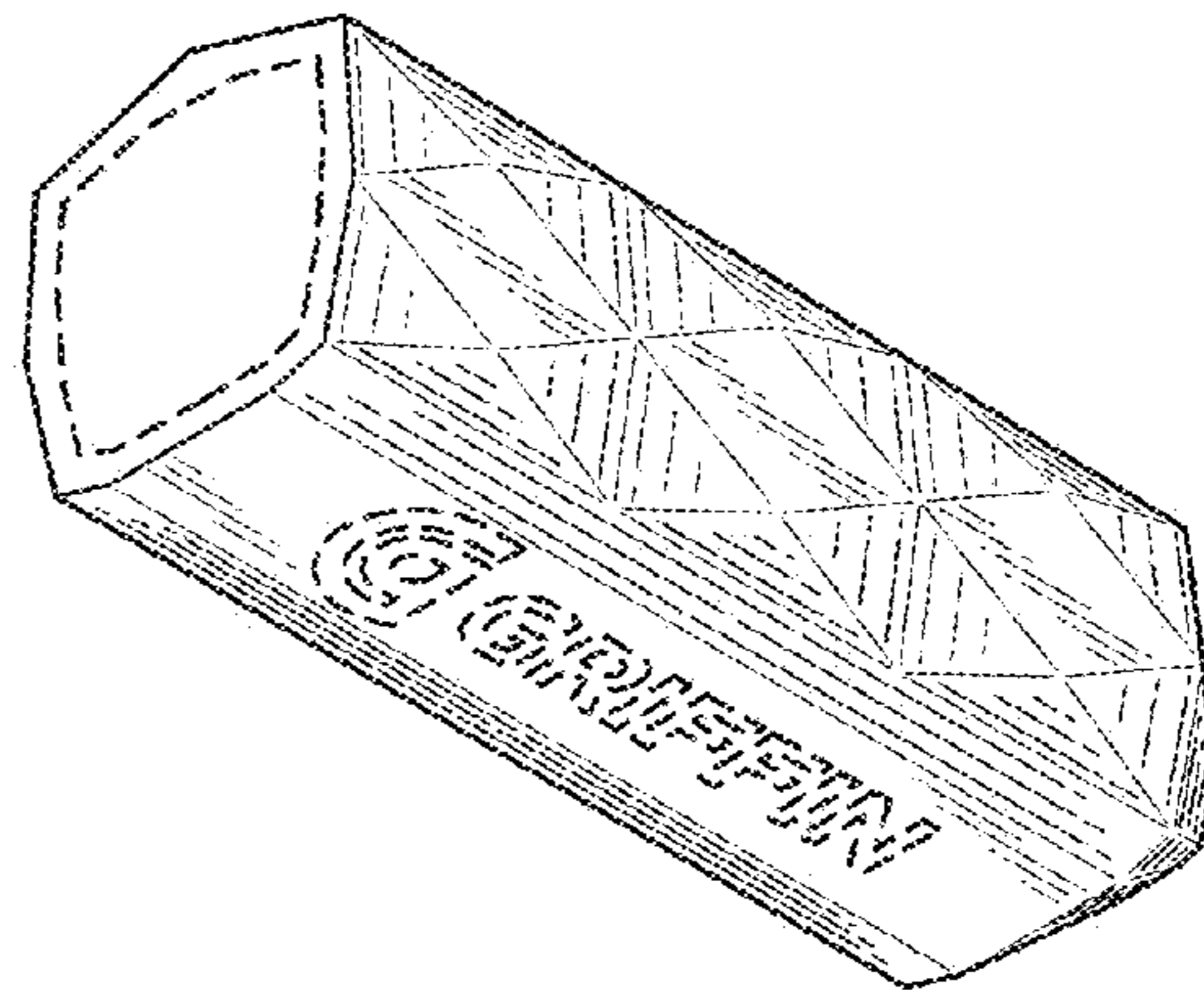

FIG. 3

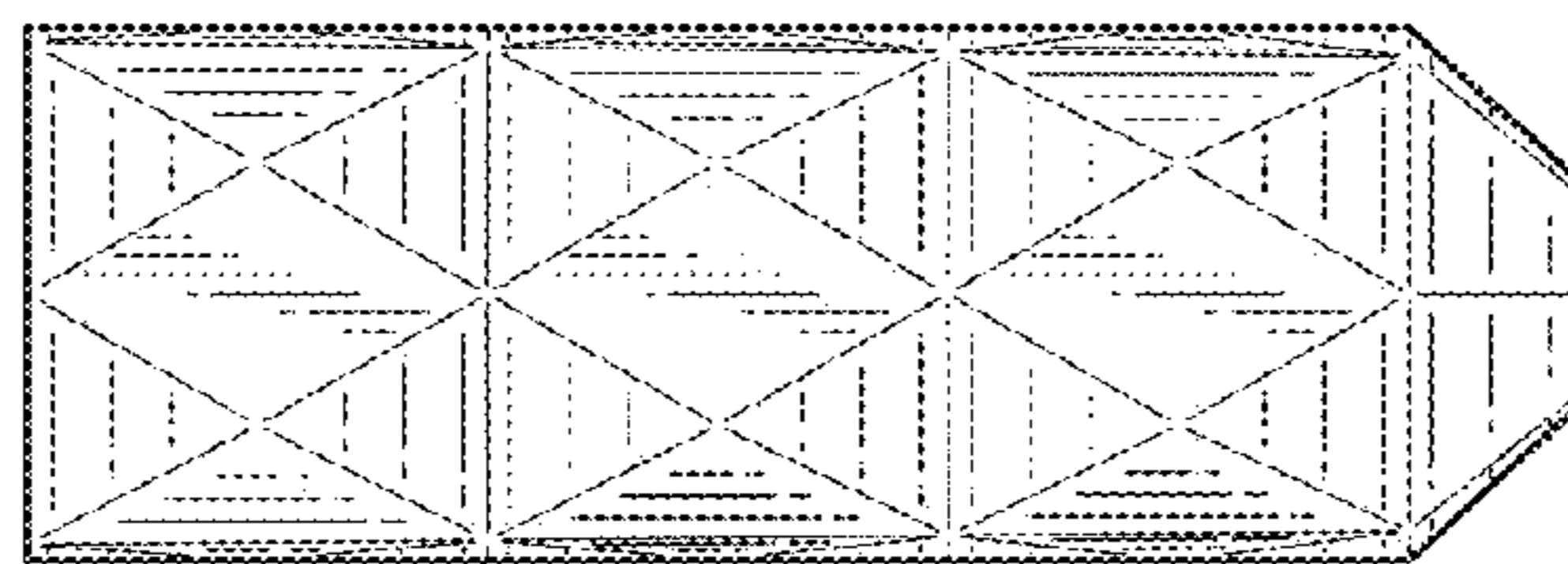

FIG. 4

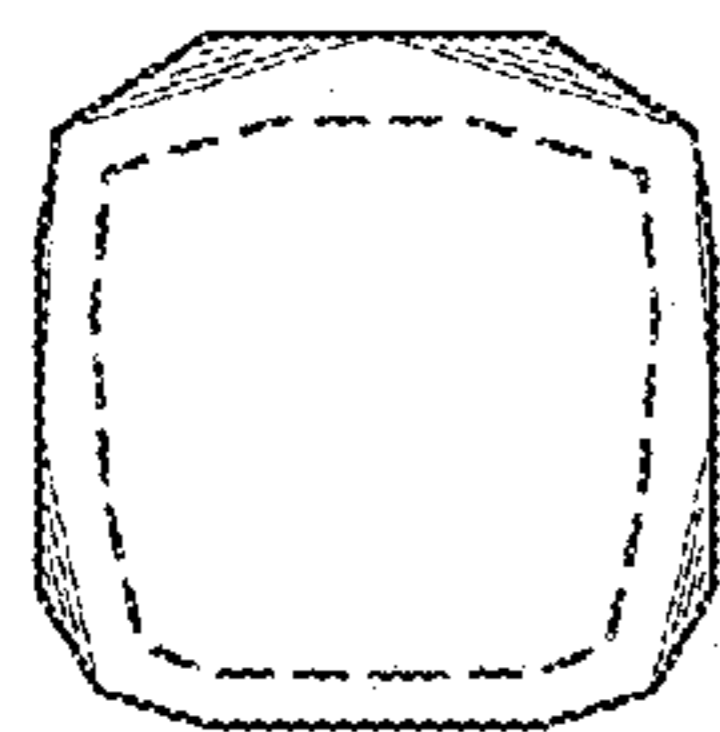

FIG. 6

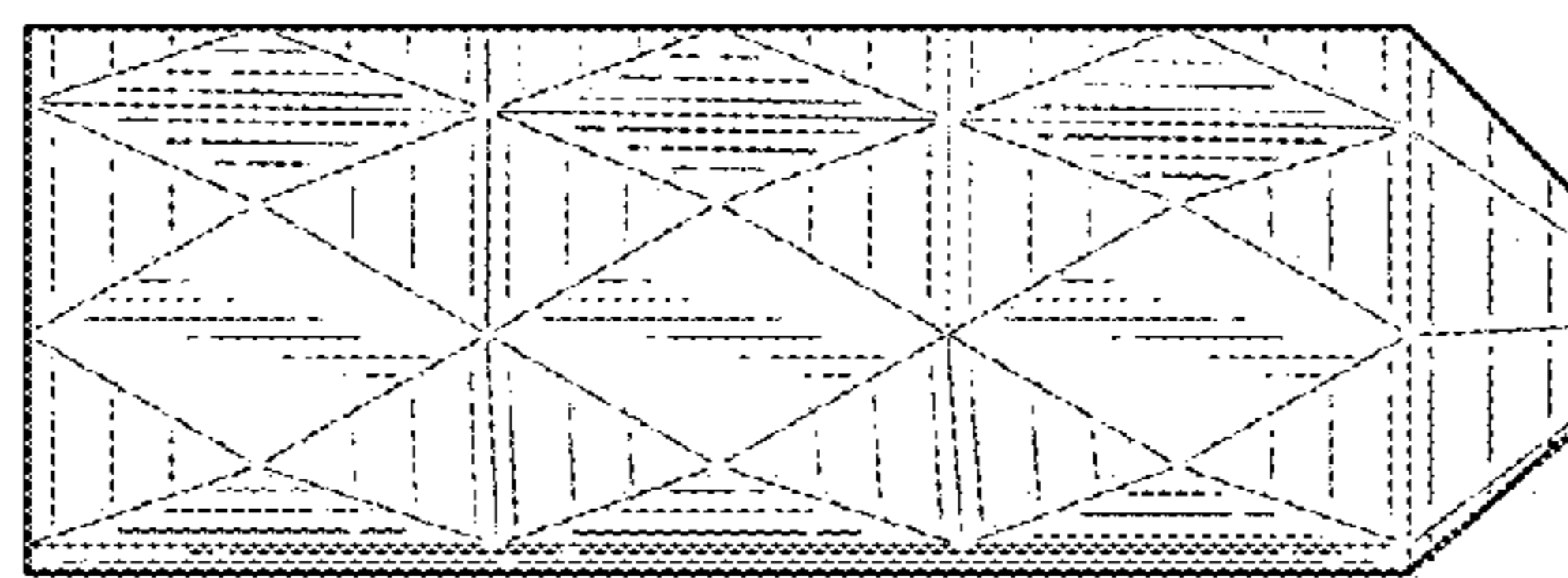

FIG. 5

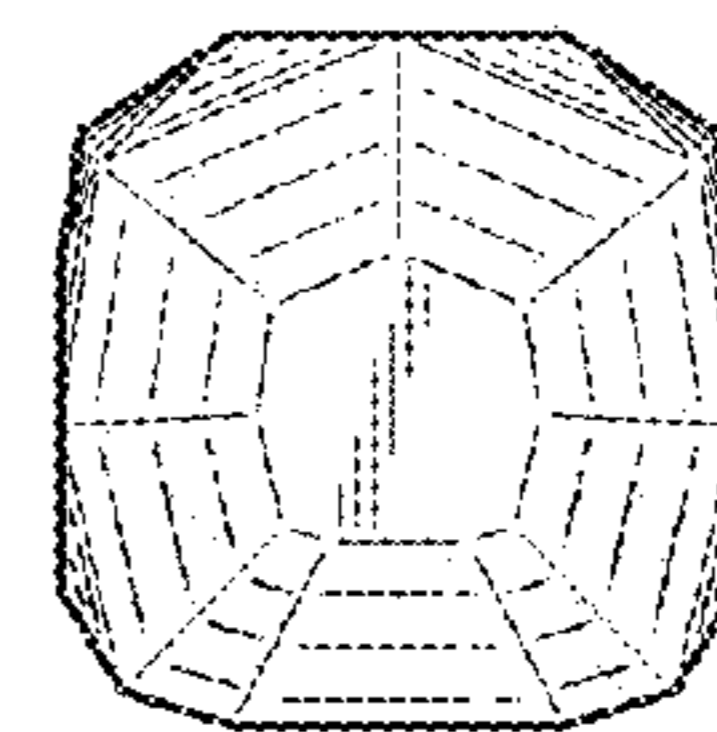

FIG. 7



FIG. 8