

US00D751992S

(12) **United States Design Patent**
Buck et al.

(10) **Patent No.:** **US D751,992 S**
(45) **Date of Patent:** **** Mar. 22, 2016**

- (54) **VERTICAL ELECTRICAL CONNECTOR HOUSING**
- (71) Applicants: **Jonathan E. Buck**, Milpitas, CA (US);
Stuart C. Stoner, Lewisberry, PA (US);
Steven E. Minich, York, PA (US);
Douglas M. Johnescu, York, PA (US);
Stephen B. Smith, Mechanicsburg, PA (US)
- (72) Inventors: **Jonathan E. Buck**, Milpitas, CA (US);
Stuart C. Stoner, Lewisberry, PA (US);
Steven E. Minich, York, PA (US);
Douglas M. Johnescu, York, PA (US);
Stephen B. Smith, Mechanicsburg, PA (US)
- (73) Assignee: **FCI AMERICAS TECHNOLOGY LLC**, Carson City, NV (US)
- (**) Term: **14 Years**
- (21) Appl. No.: **29/526,301**
- (22) Filed: **May 7, 2015**

D402,637	S	12/1998	Carpenter, Jr.
6,461,202	B2	10/2002	Kline
6,960,103	B2	11/2005	Tokunaga
6,994,569	B2	2/2006	Minich et al.
7,118,391	B2	10/2006	Minich et al.
D550,628	S	9/2007	Whiteman, Jr. et al.
7,278,856	B2	10/2007	Minich
7,338,321	B2	3/2008	Laurx
7,549,897	B2	6/2009	Fedder et al.
D611,420	S	3/2010	Takada et al.
D611,421	S	3/2010	Takada et al.
D611,905	S	3/2010	Takada et al.
D611,906	S	3/2010	Takada et al.
8,408,939	B2	4/2013	Davis et al.
D712,841	S	9/2014	Buck et al.
D712,842	S	9/2014	Buck et al.
D712,843	S	9/2014	Buck et al.
D712,844	S	9/2014	Buck et al.
D713,356	S	9/2014	Buck et al.
D713,799	S	9/2014	Buck et al.
D724,032	S	3/2015	Buck et al.
8,998,645	B2	4/2015	Vanaleck et al.
D738,314	S *	9/2015	Buck D13/147
2004/0259420	A1	12/2004	Wu
2007/0190825	A1	8/2007	Shuey et al.
2009/0068902	A1	3/2009	Nagata
2012/0214343	A1	8/2012	Buck et al.
2014/0248794	A1	9/2014	Khazen et al.

- Related U.S. Application Data**
- (60) Continuation of application No. 29/496,690, filed on Jul. 16, 2014, now Pat. No. Des. 731,437, which is a division of application No. 29/443,206, filed on Jan. 14, 2013, now Pat. No. Des. 713,346.
- (51) **LOC (10) Cl.** **13-03**
- (52) **U.S. Cl.**
USPC **D13/154**
- (58) **Field of Classification Search**
USPC D13/133, 146, 147, 154, 184, 199
See application file for complete search history.

(56) **References Cited**
U.S. PATENT DOCUMENTS

D210,829	S	4/1968	Hanlon et al.
D213,697	S	4/1969	Oxley
5,181,855	A	1/1993	Mosquera et al.

- OTHER PUBLICATIONS**
- U.S. Appl. No. 29/497,094, filed Jul. 21, 2014, Buck et al.
 - U.S. Appl. No. 29/498,817, filed Aug. 8, 2014, Buck et al.
 - U.S. Appl. No. 29/498,823, filed Aug. 8, 2014, Buck et al.
 - U.S. Appl. No. 29/498,828, filed Aug. 8, 2014, Buck et al.
 - U.S. Appl. No. 29/517,078, filed Jan. 14, 2013, Buck et al.
 - U.S. Appl. No. 29/526,541, filed May 11, 2015, Buck et al.
 - U.S. Appl. No. 29/526,298, filed May 7, 2015, Buck et al.
 - U.S. Appl. No. 29/526,295, filed May 7, 2015, Buck et al.
 - U.S. Appl. No. 29/526,296, filed May 7, 2015, Buck et al.
 - U.S. Appl. No. 29/533,779, filed Jul. 22, 2015, Buck et al.
 - U.S. Appl. No. 29/533,910, filed Jul. 23, 2015, Buck et al.

* cited by examiner

Primary Examiner — Daniel Bui

(74) *Attorney, Agent, or Firm* — Baker & Hostetler LLP

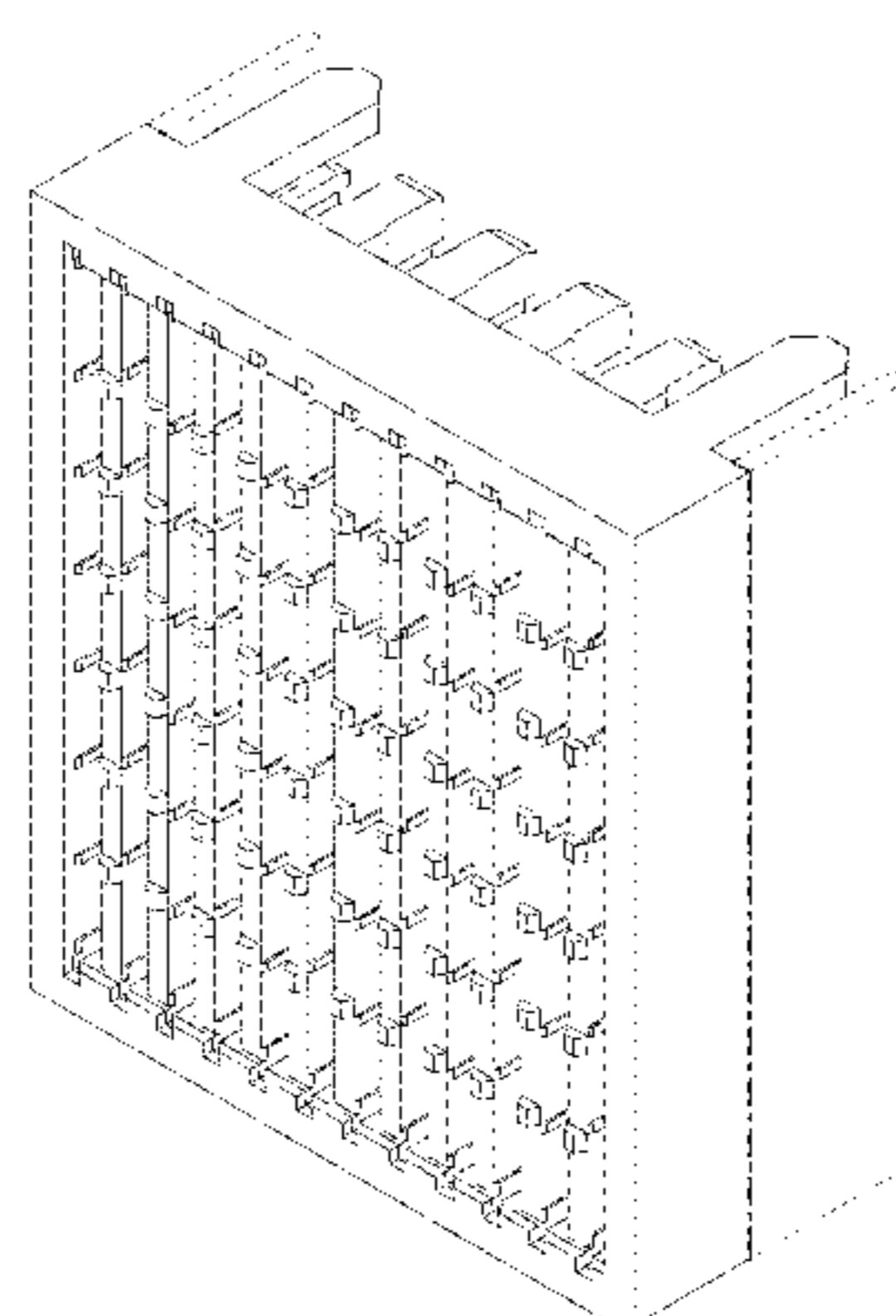
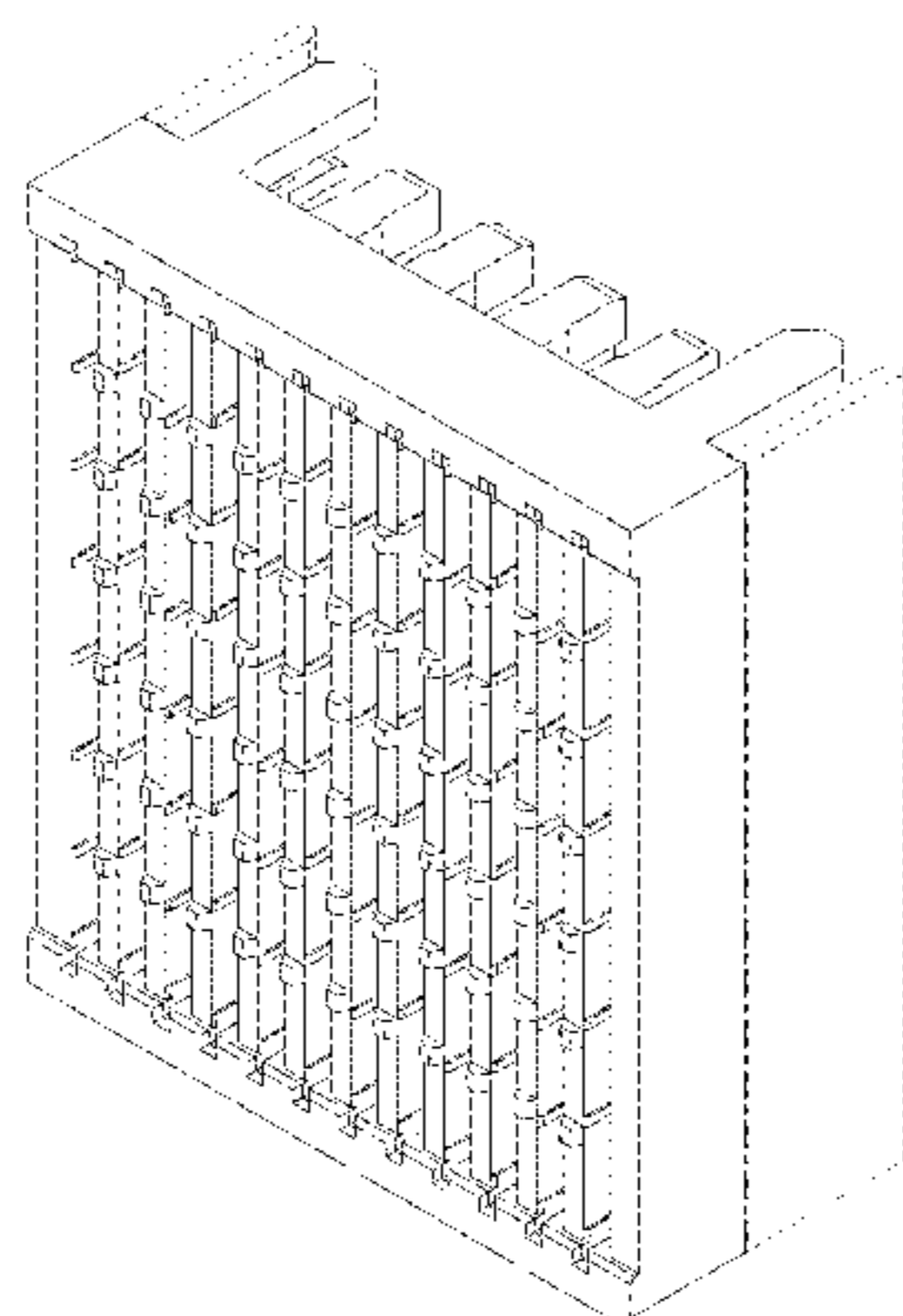

(57)

CLAIM

The ornamental design for a vertical electrical connector housing, as shown and described.

DESCRIPTION

FIG. 1 is a top, left, rear perspective view of a vertical electrical connector housing according to one embodiment of our design;

FIG. 2 is a bottom, left, rear perspective view thereof;

FIG. 3 is a top, left, front perspective view thereof;

FIG. 4 is a bottom, right, front perspective view thereof;

FIG. 5 is another top, left, rear perspective view thereof;

FIG. 6 is another bottom, right, front perspective view thereof;

FIG. 7 is a rear elevation view thereof;

FIG. 8 is a front elevation view thereof;

FIG. 9 is a top plan view thereof;

FIG. 10 is a bottom plan view thereof;

FIG. 11 is a left side elevation view thereof;

FIG. 12 is a right side elevation view thereof;

FIG. 13 is a top, left, rear perspective view of a vertical electrical connector housing according to another embodiment of our design;

FIG. 14 is a bottom, left, rear perspective view thereof;

FIG. 15 is a top, left, front perspective view thereof;

FIG. 16 is a bottom, right, front perspective view thereof;

FIG. 17 is another top, left, rear perspective view thereof;

FIG. 18 is another bottom, right, front perspective view thereof;

FIG. 19 is a rear elevation view thereof;

FIG. 20 is a front elevation view thereof;

FIG. 21 is a top plan view thereof;

FIG. 22 is a bottom plan view thereof;

FIG. 23 is a left side elevation view thereof; and,

FIG. 24 is a right side elevation view thereof.

The broken line portion of the figure drawings is included to show unclaimed subject matter only for the purpose of illustrating environment and forms no part of the claimed design.

The dash-dot line represents the boundary of the claim design.

In a preferred embodiment, the nature of this product is an electrical component that can take the form of a vertical electrical connector housing.

1 Claim, 10 Drawing Sheets

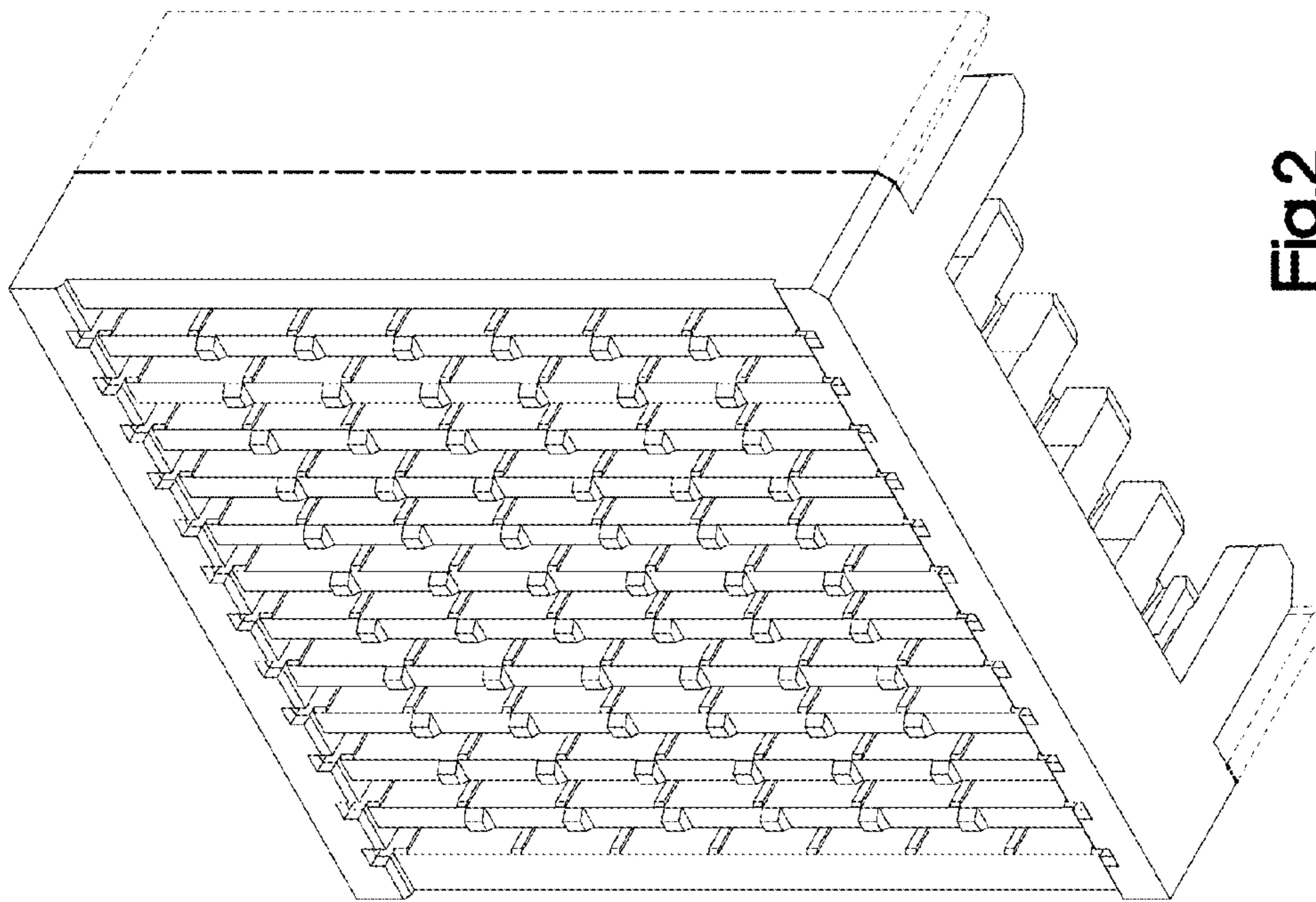

Fig. 2

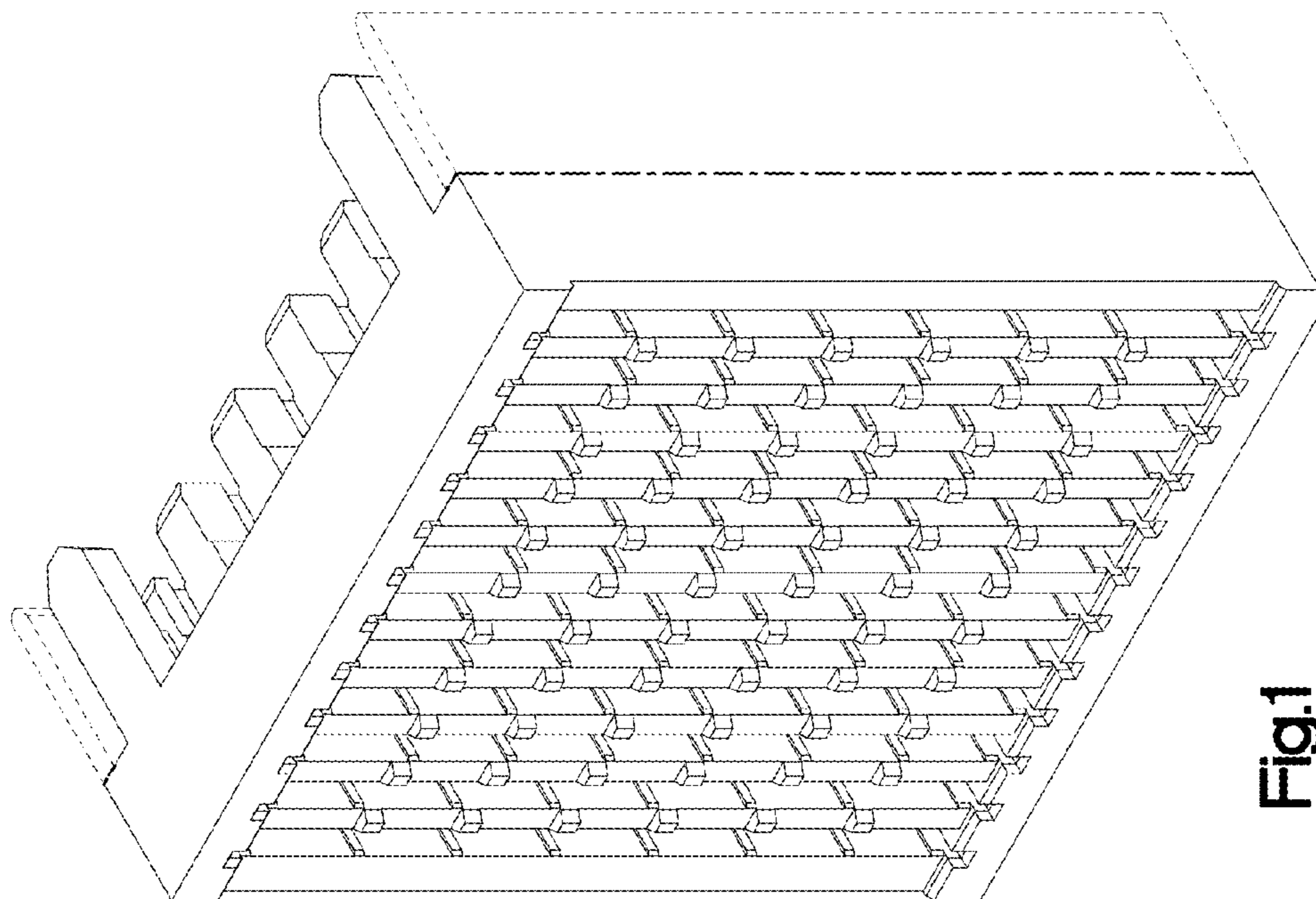

Fig. 1

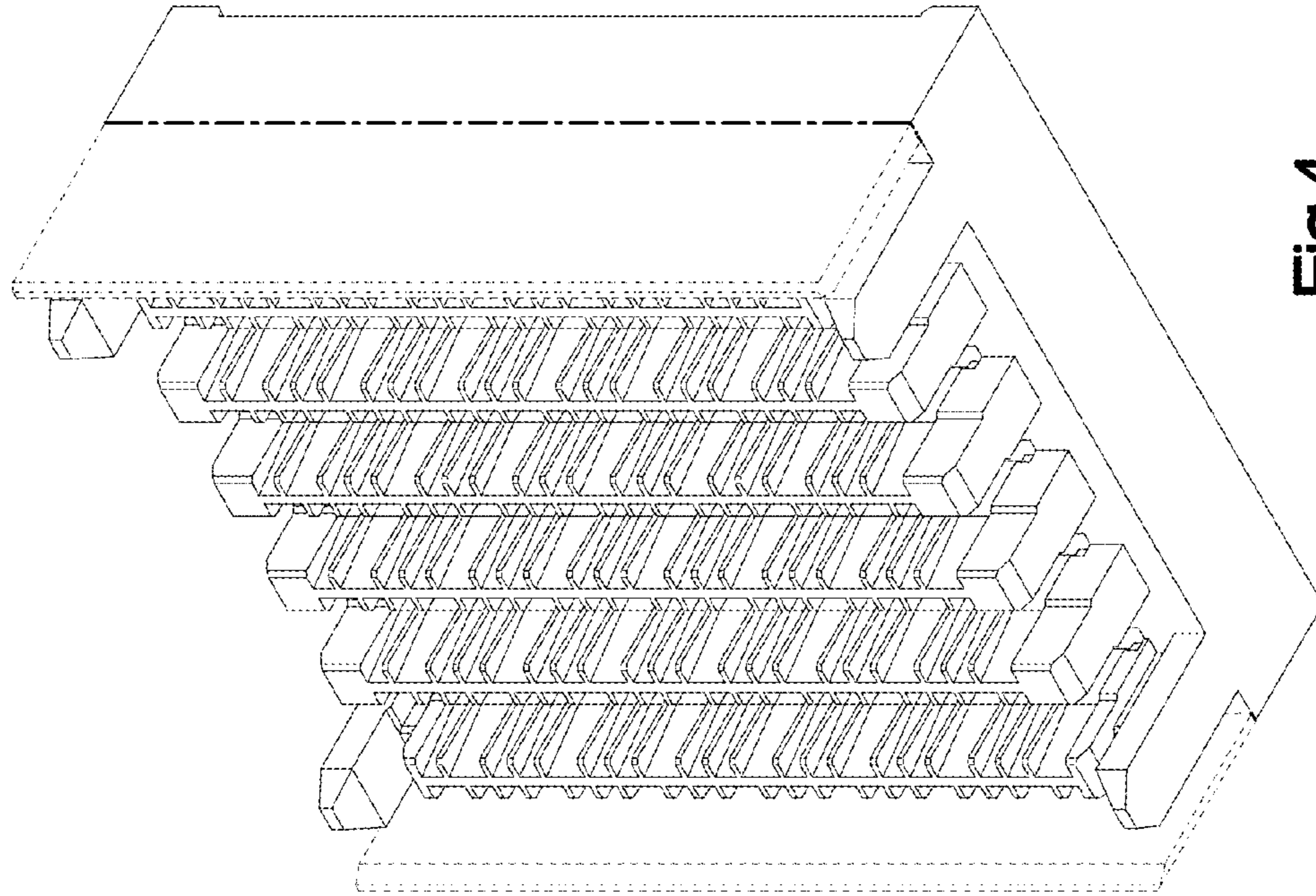

Fig.4

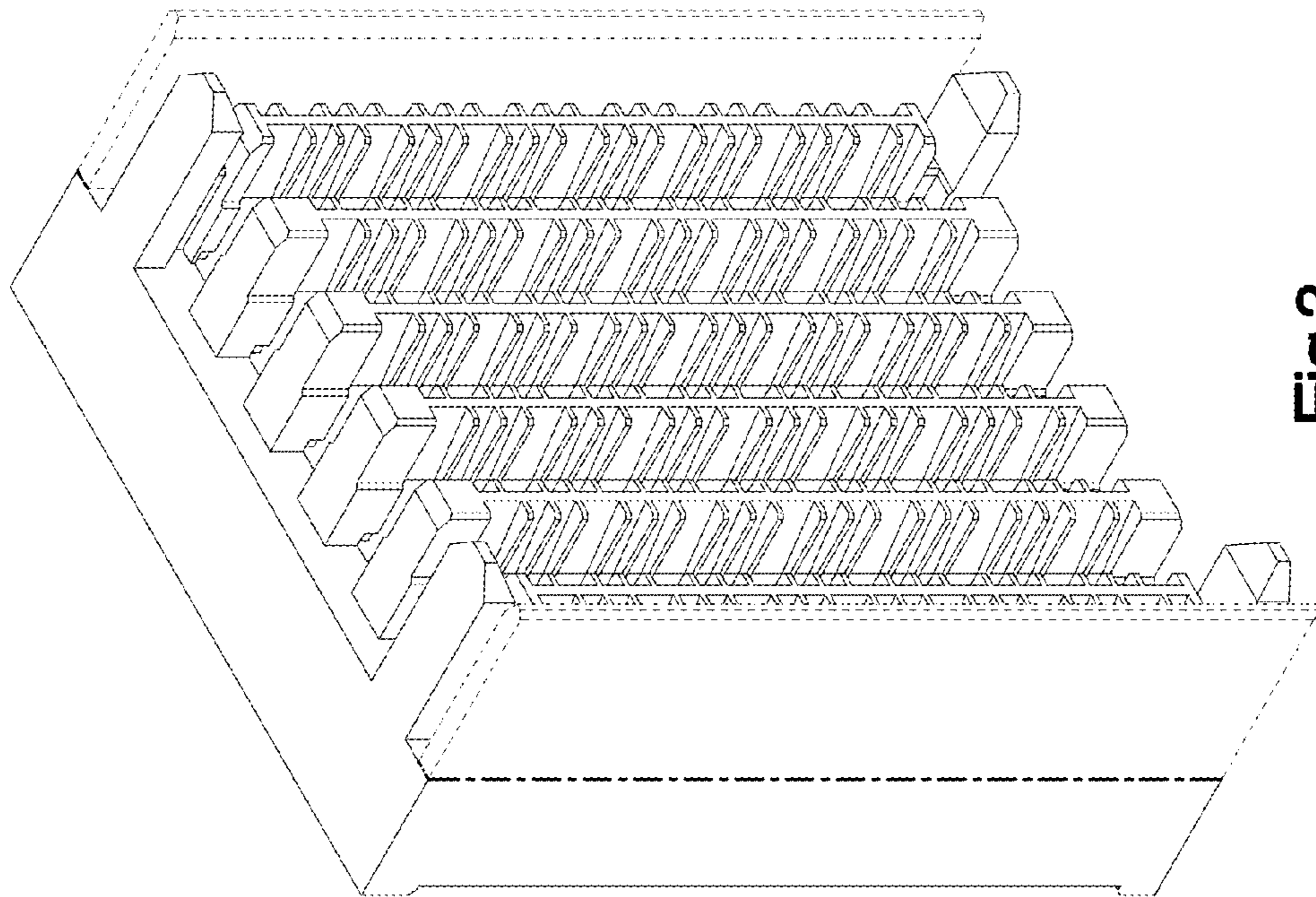

Fig.3

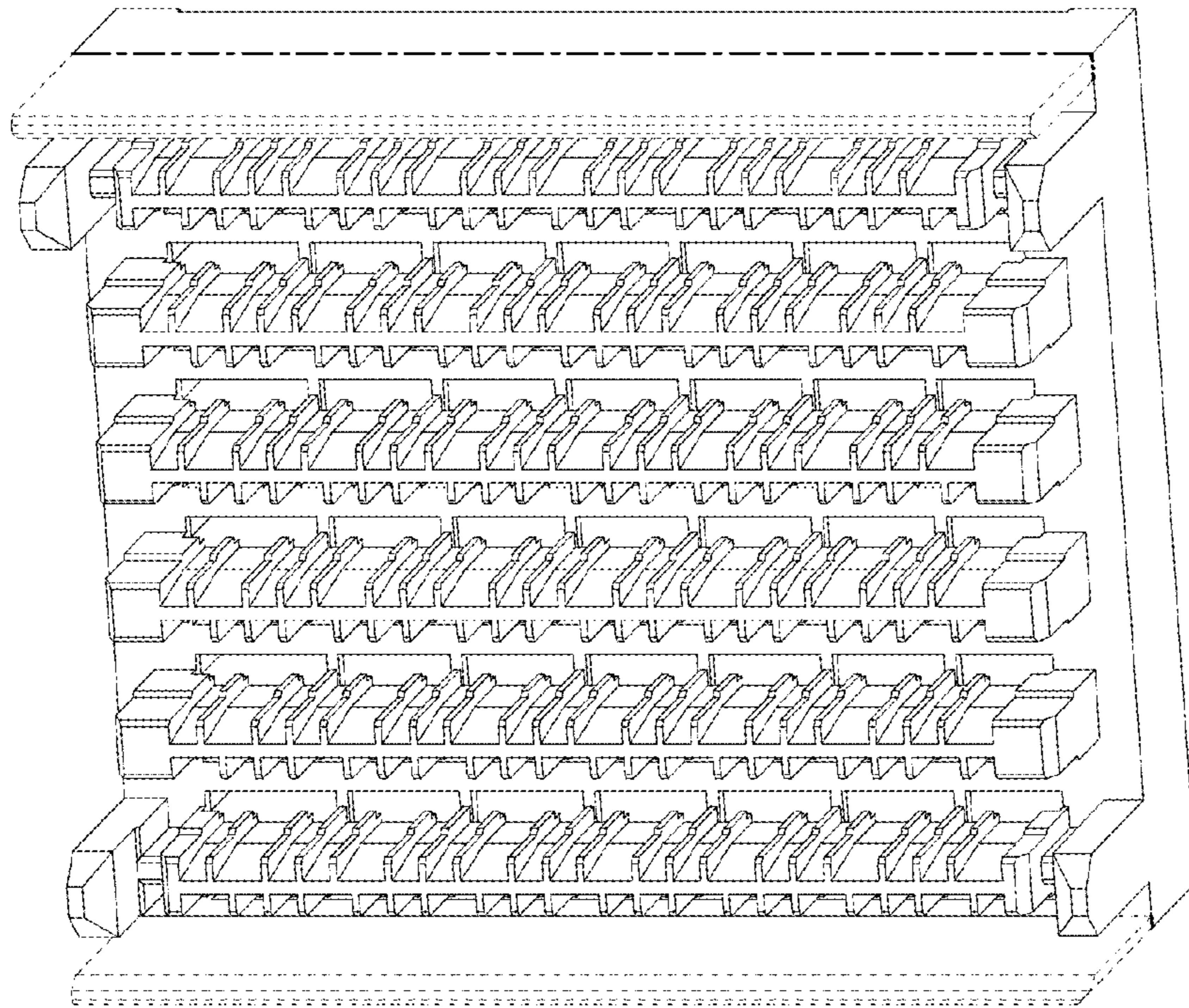

Fig.6

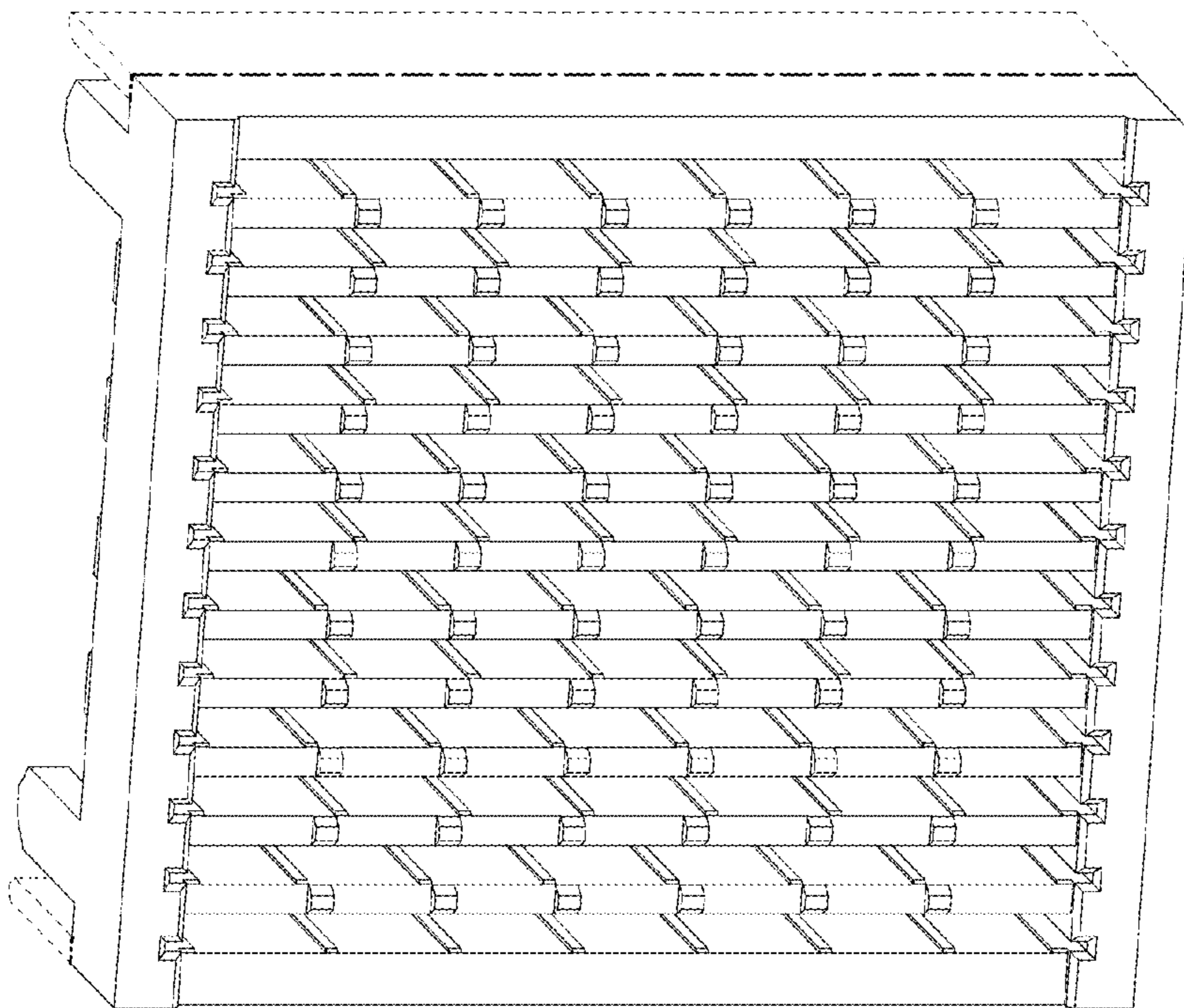

Fig.5

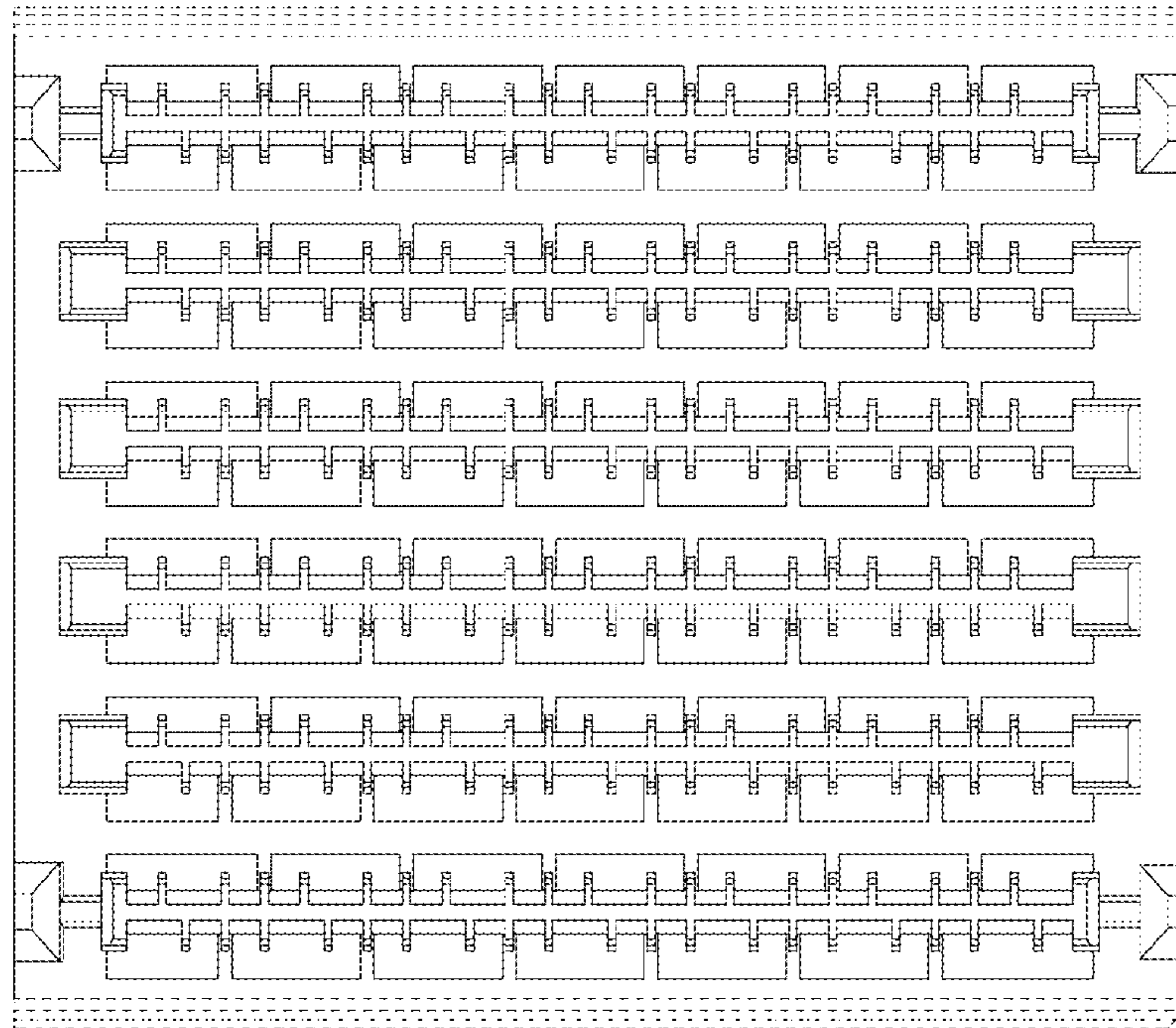

Fig. 8

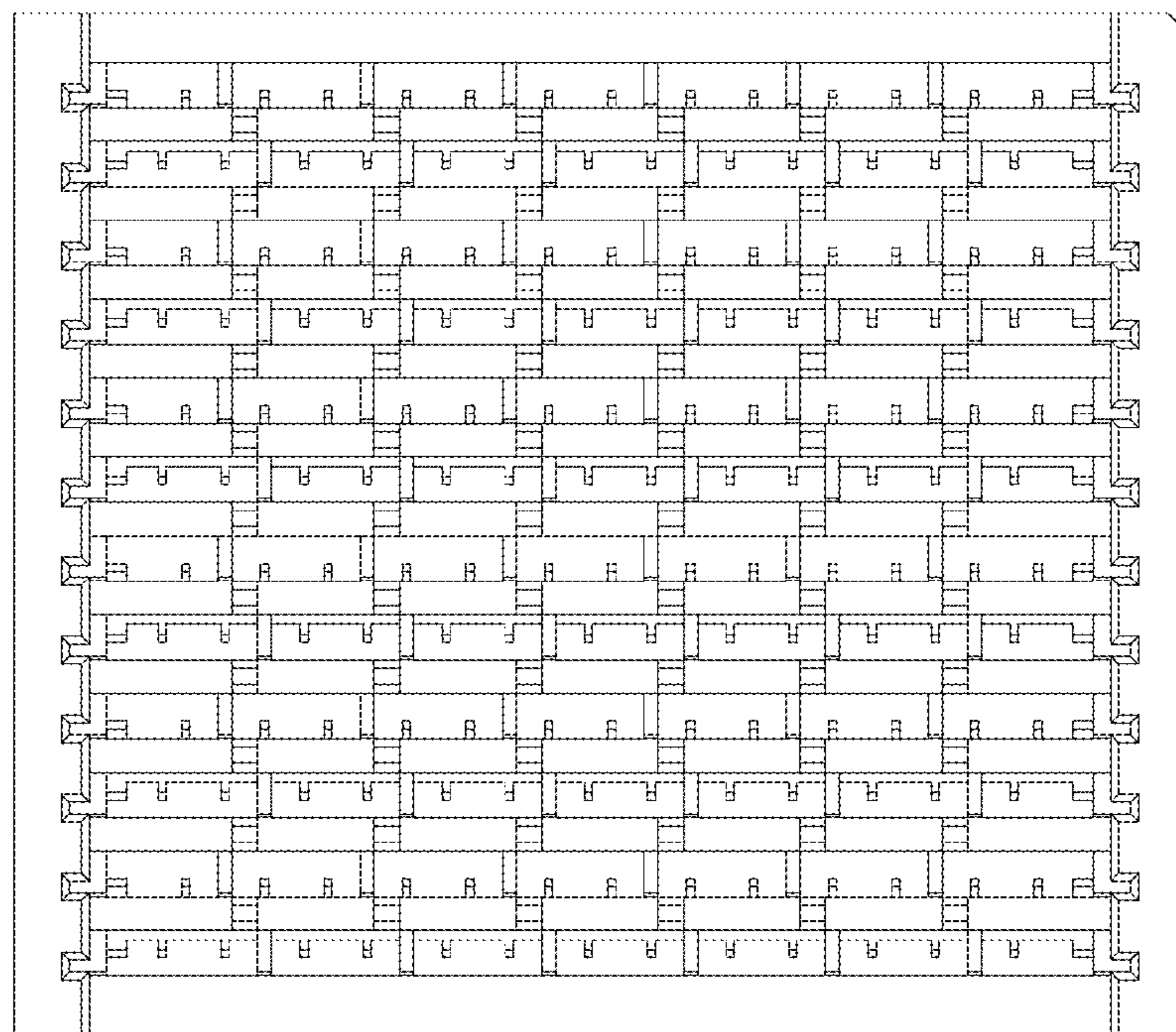

Fig. 7

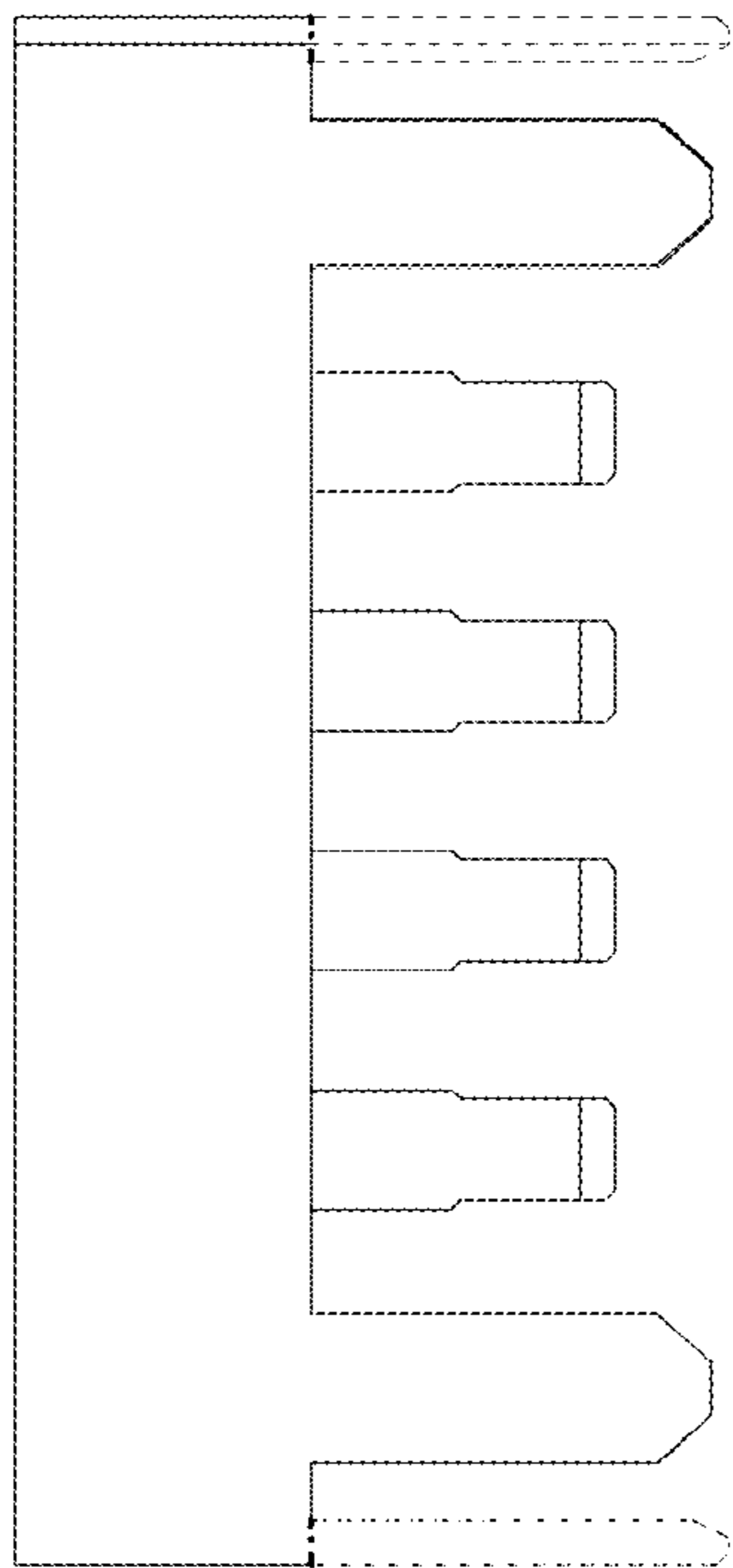

Fig.9

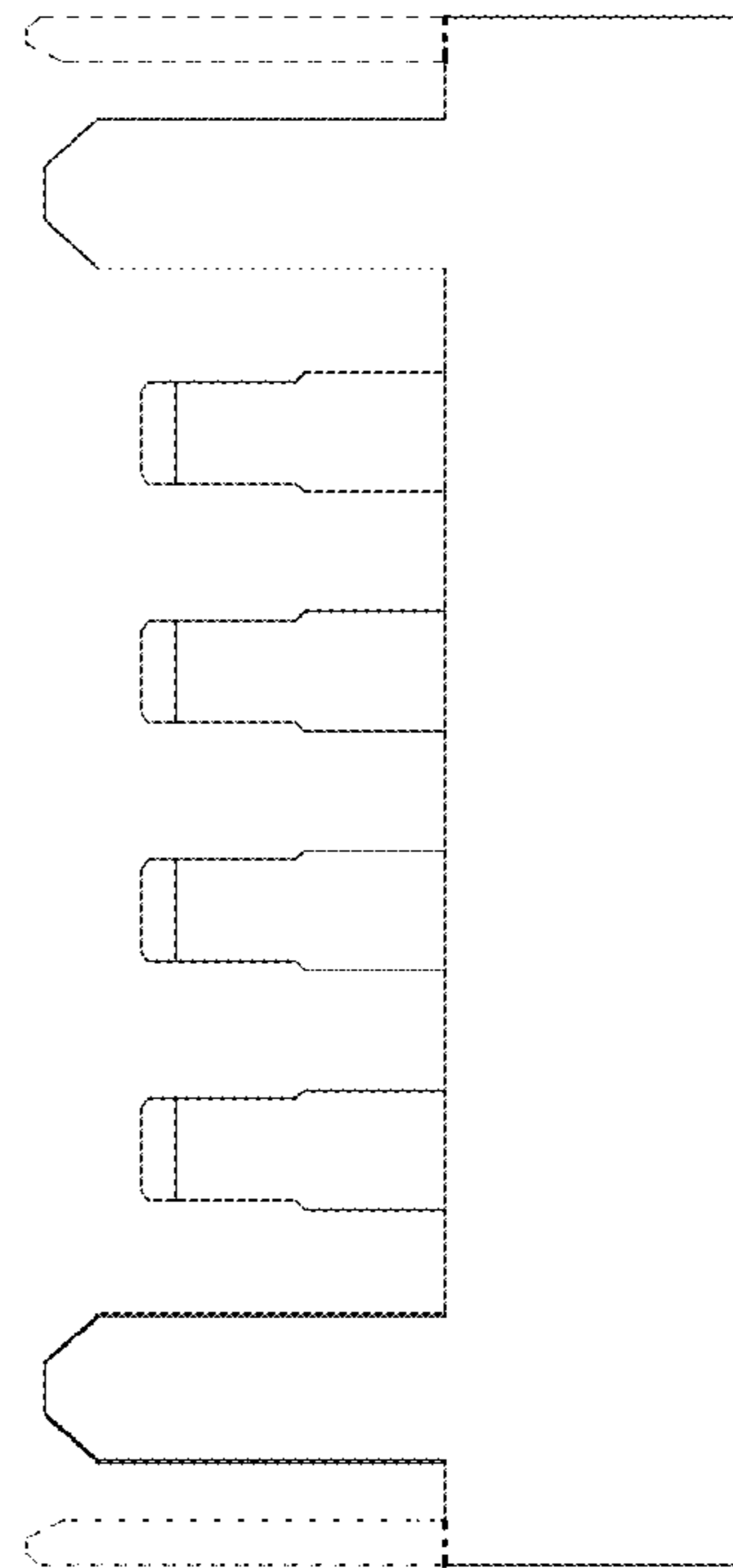

Fig.10

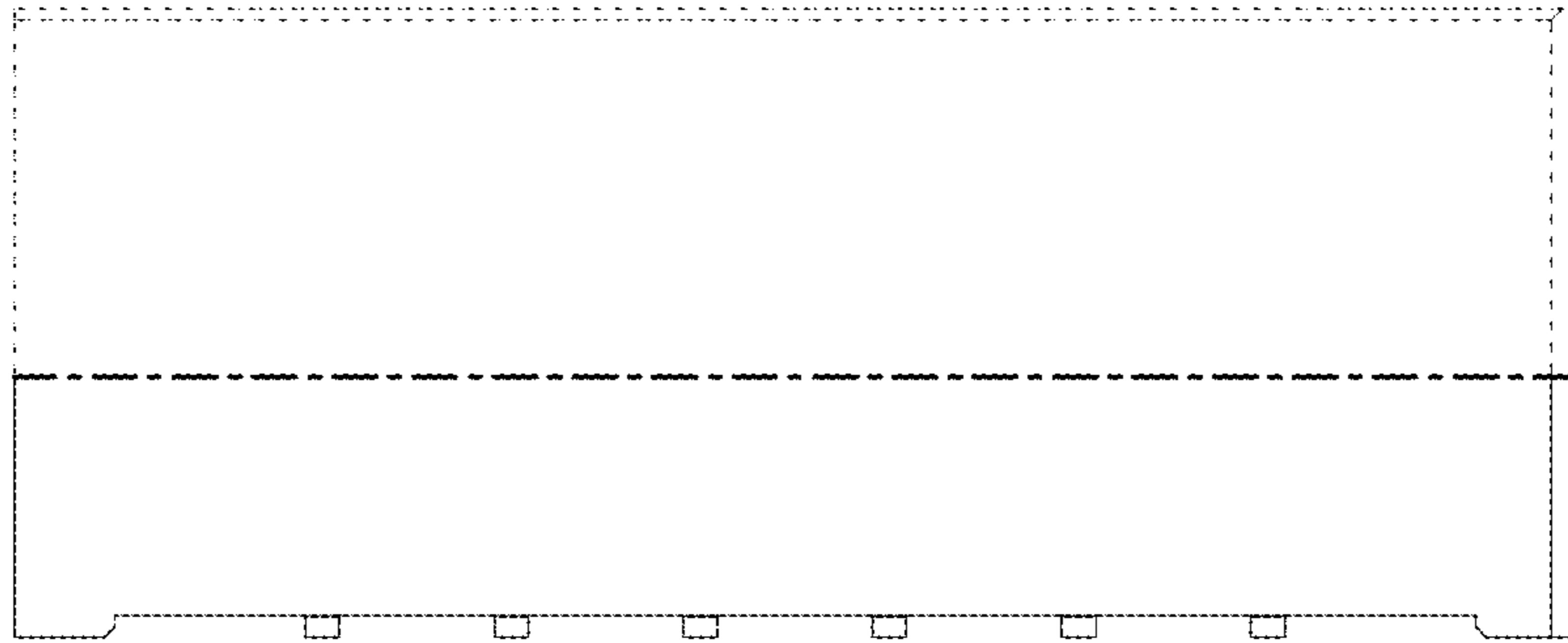

Fig.11



Fig.12

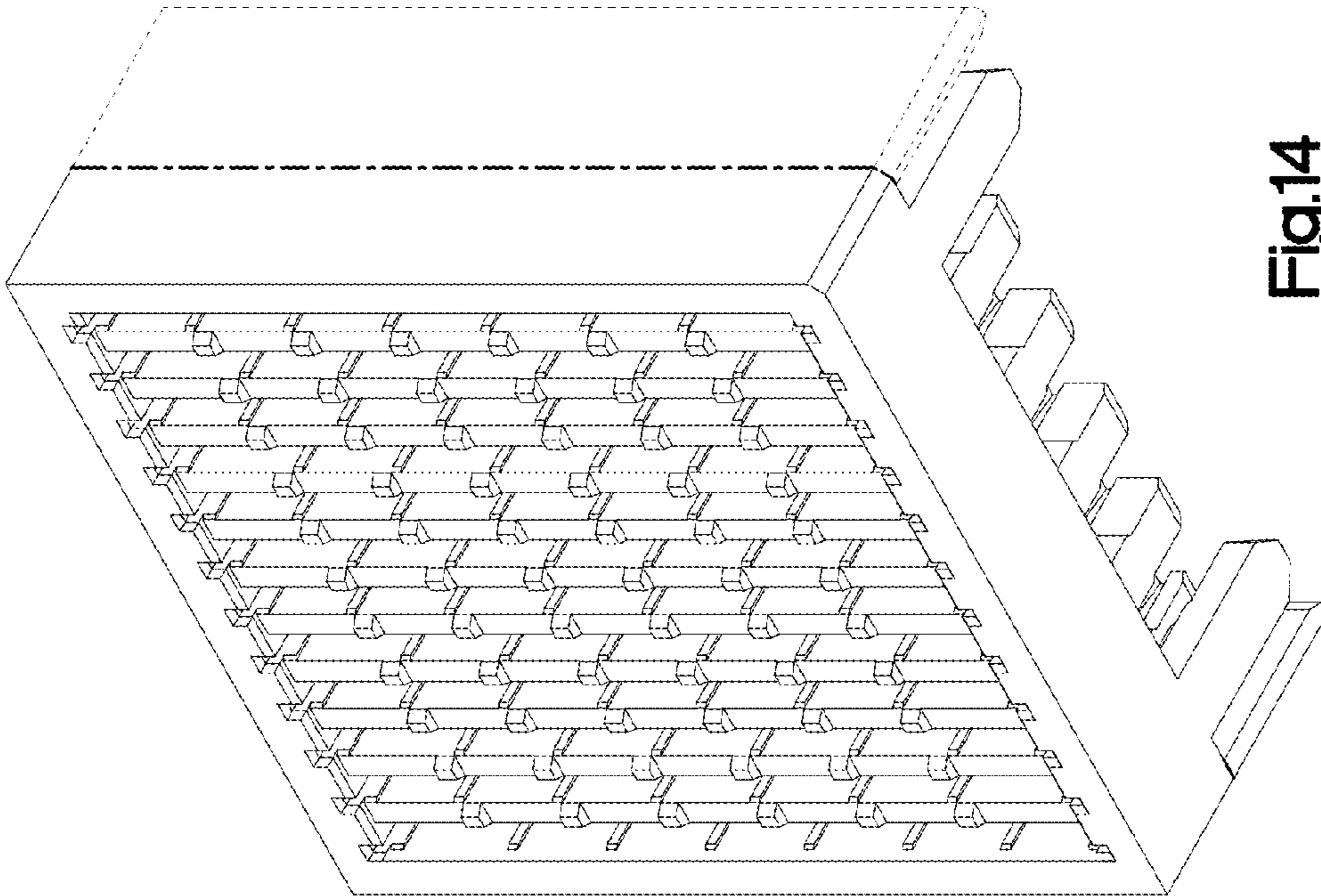

Fig.14

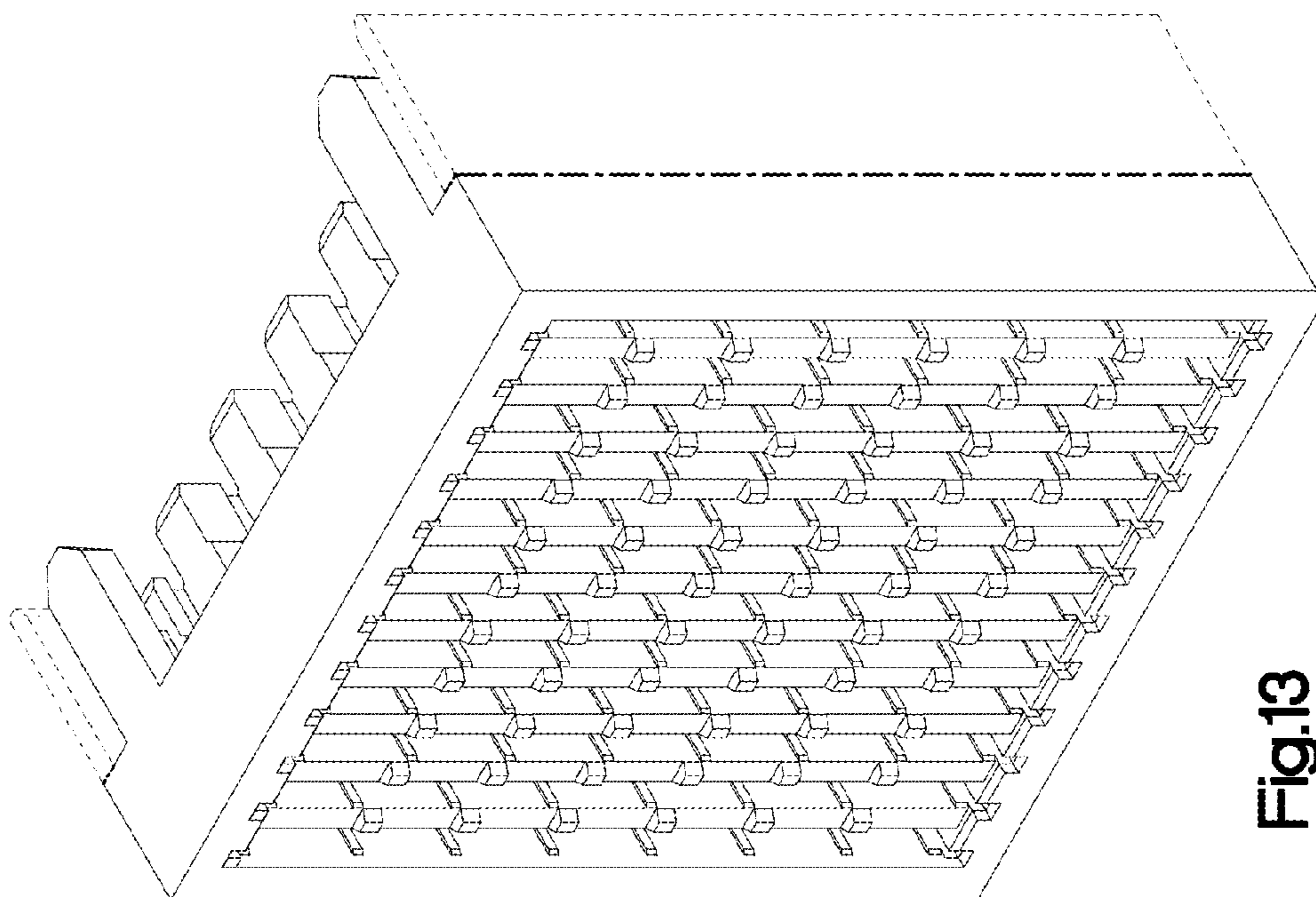

Fig.13

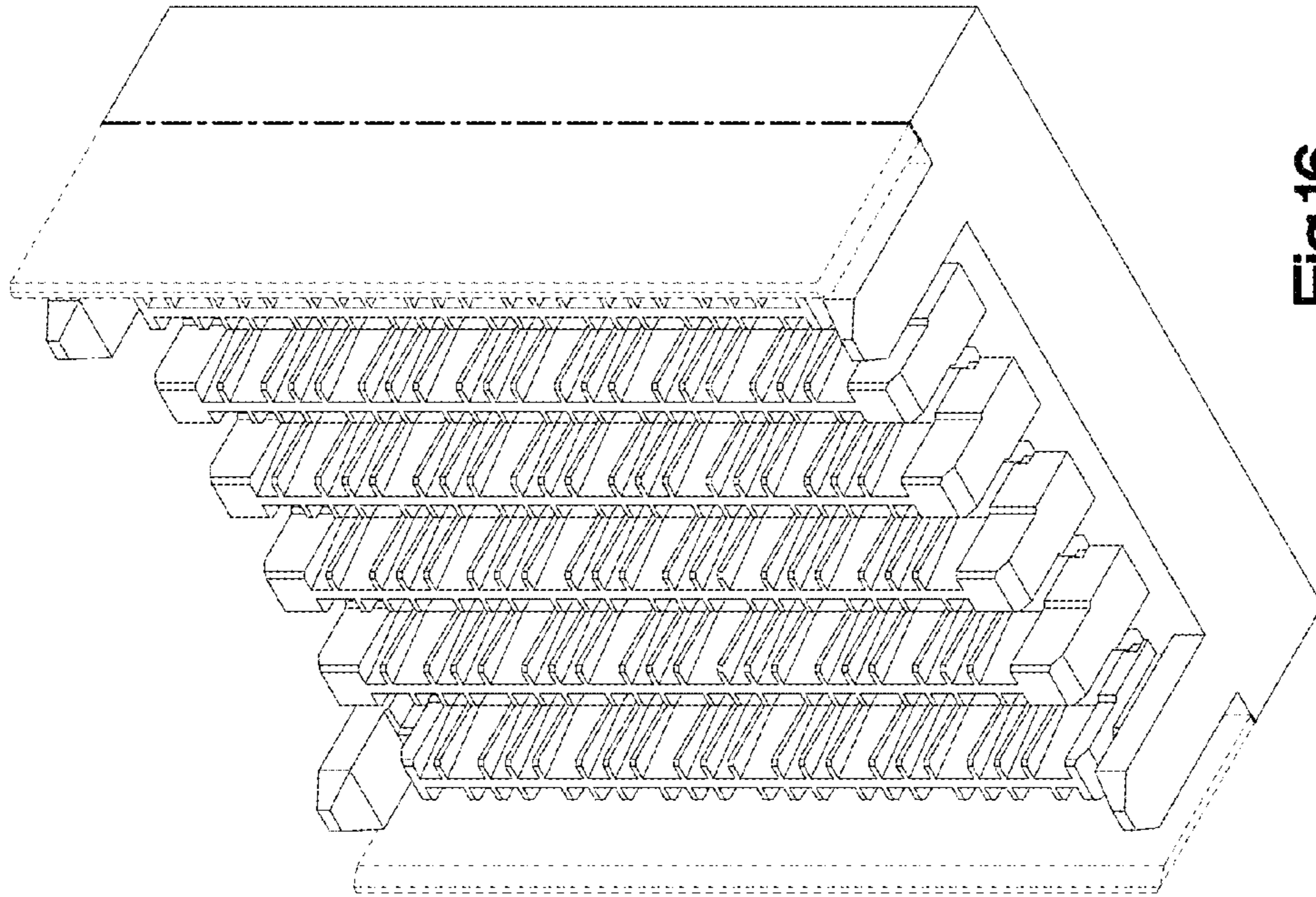

Fig.16

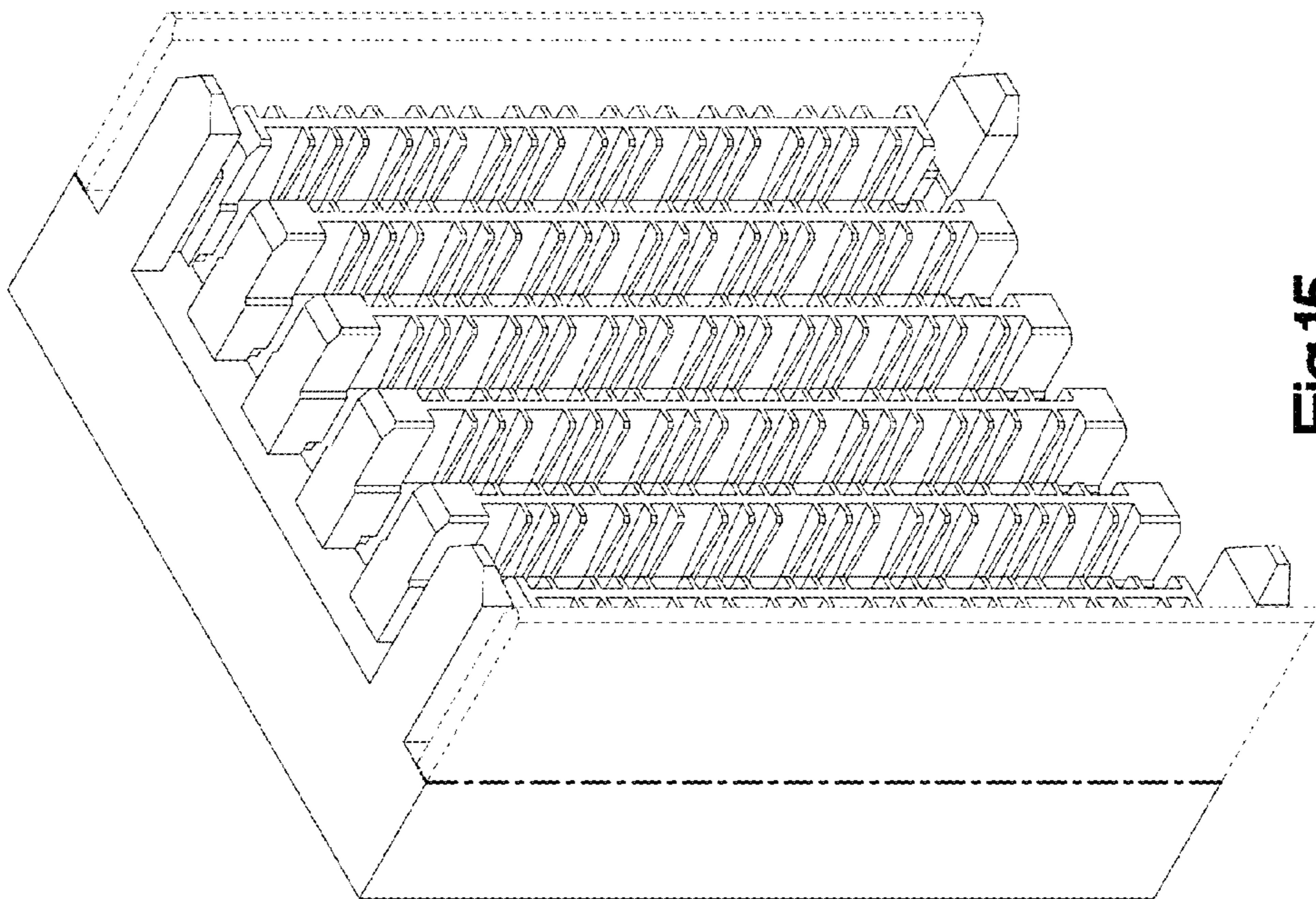

Fig.15

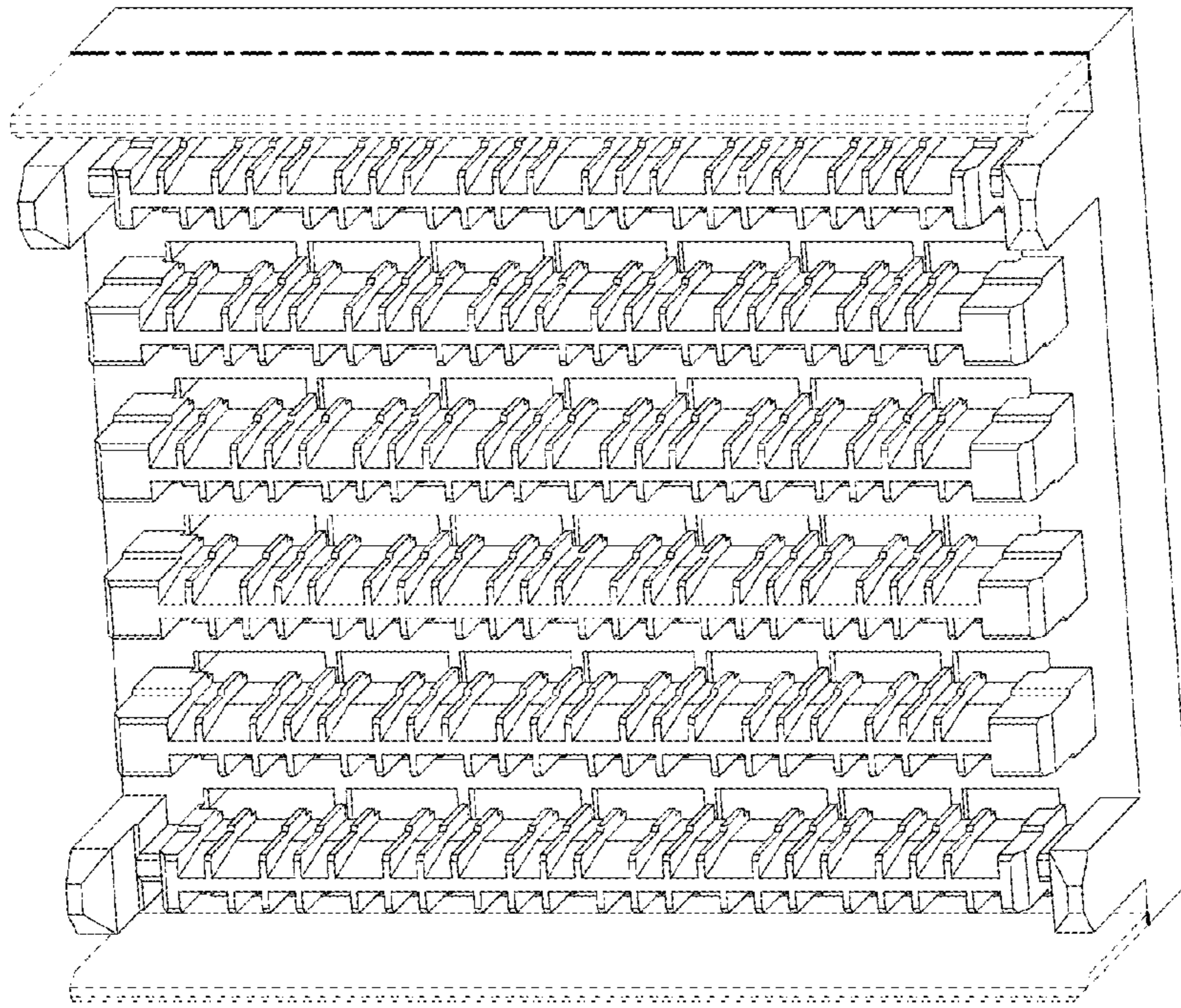

Fig.18

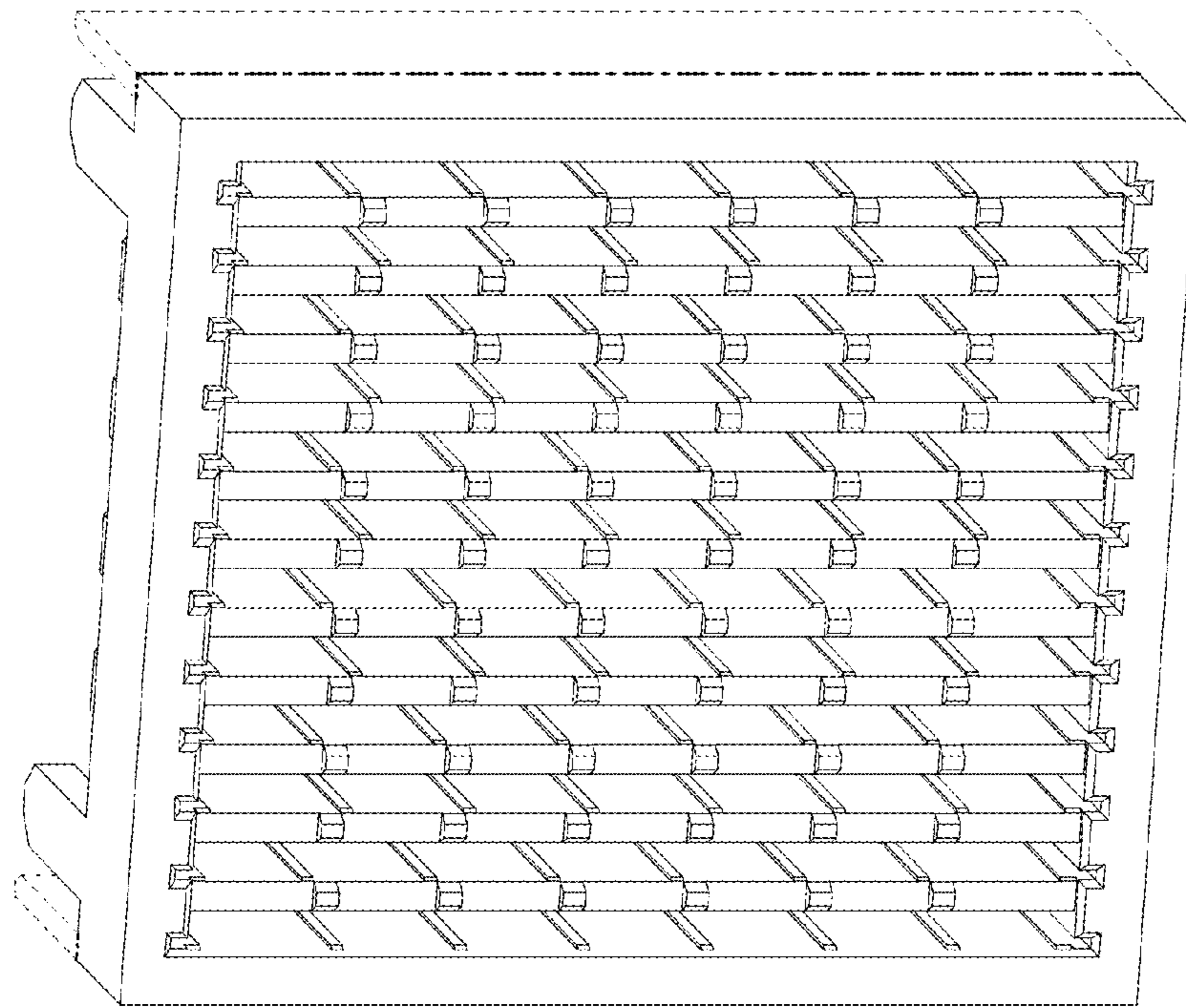

Fig.17

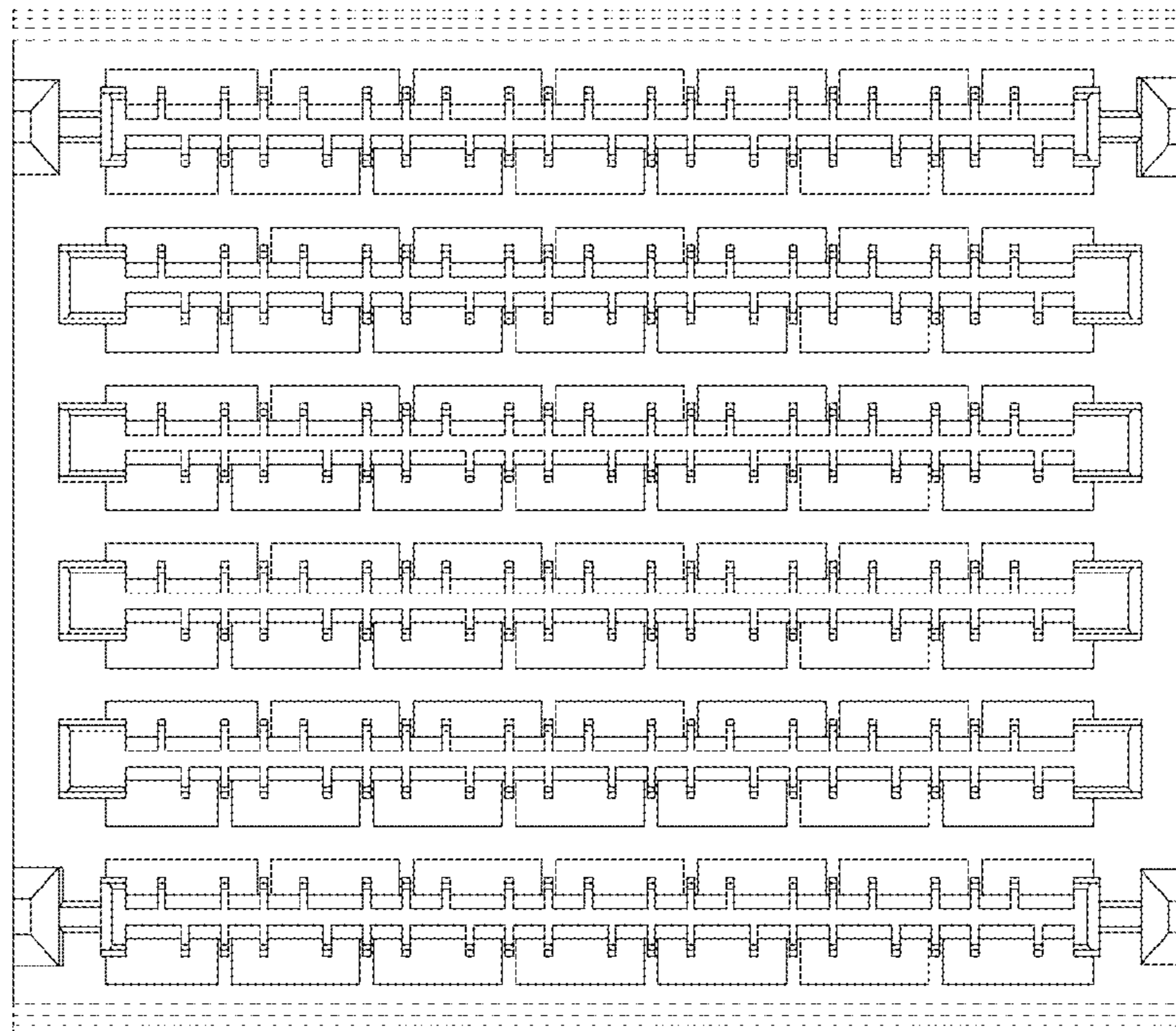

Fig.20

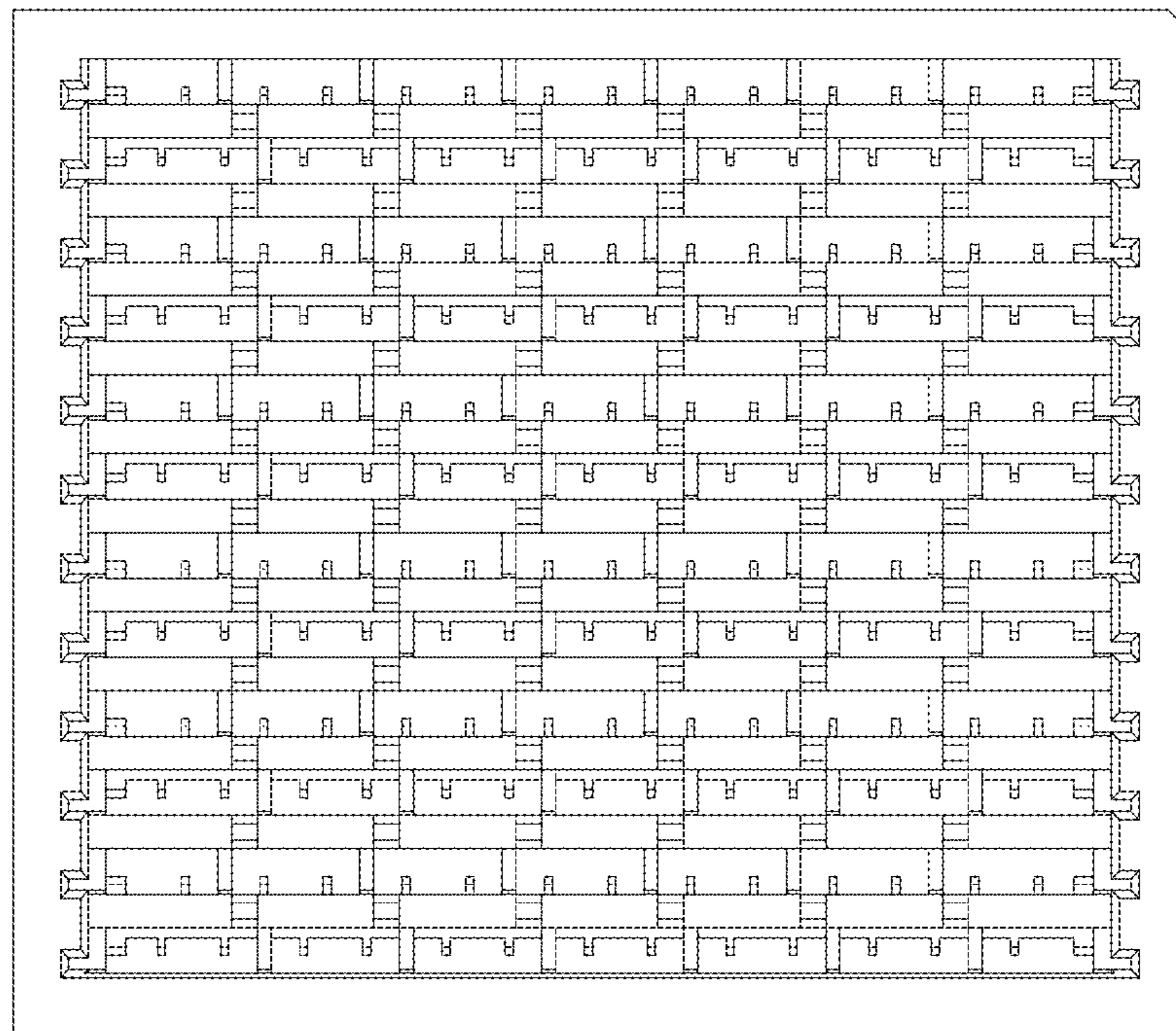

Fig.19

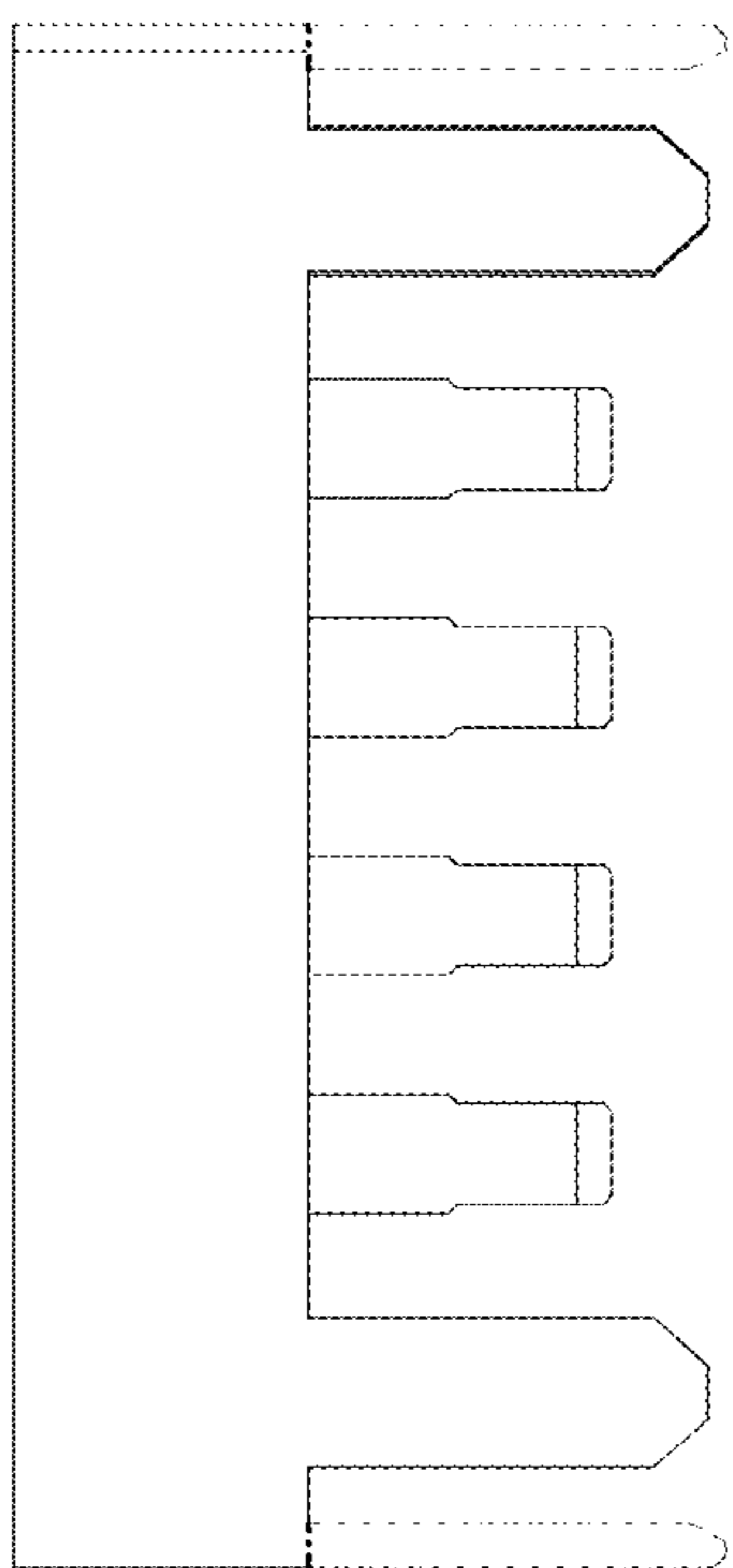

Fig. 21

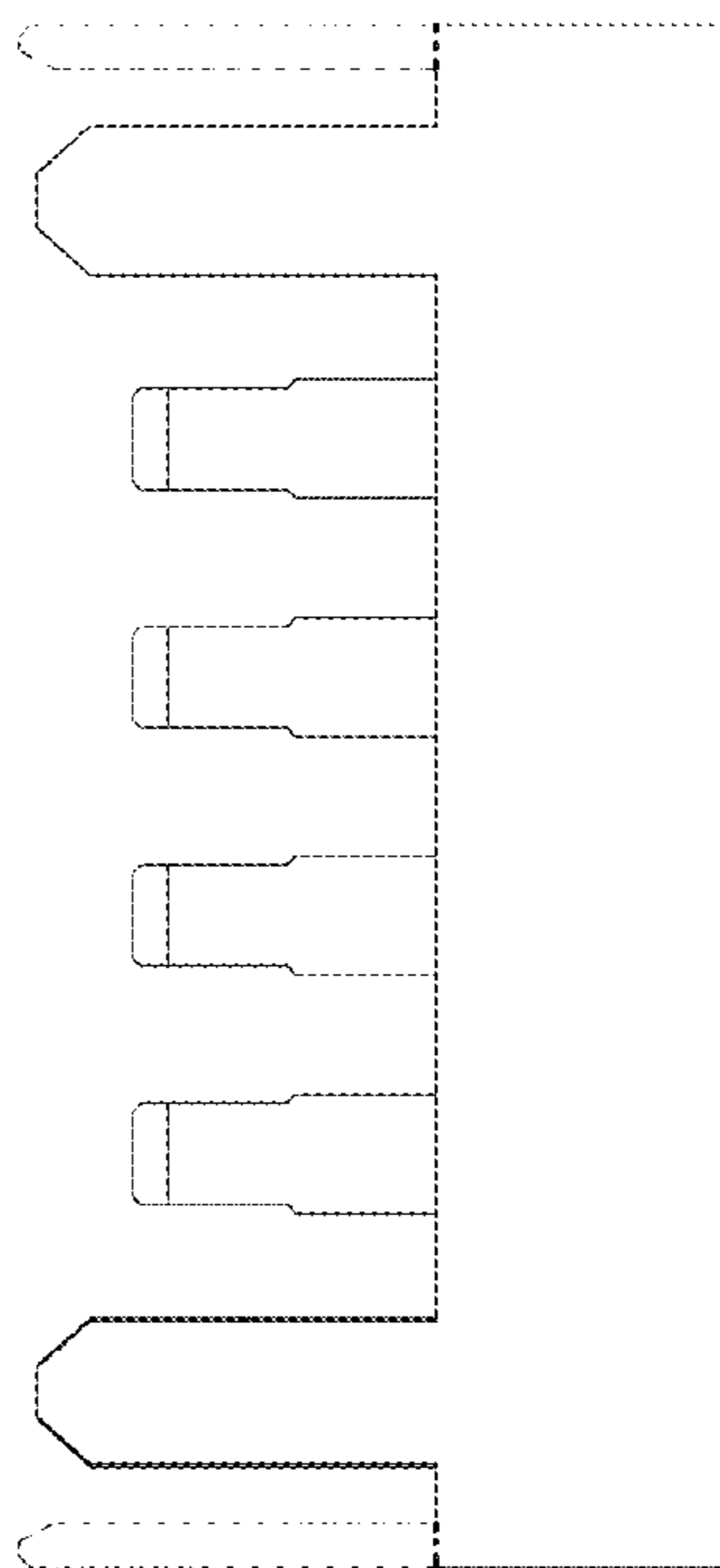

Fig. 22

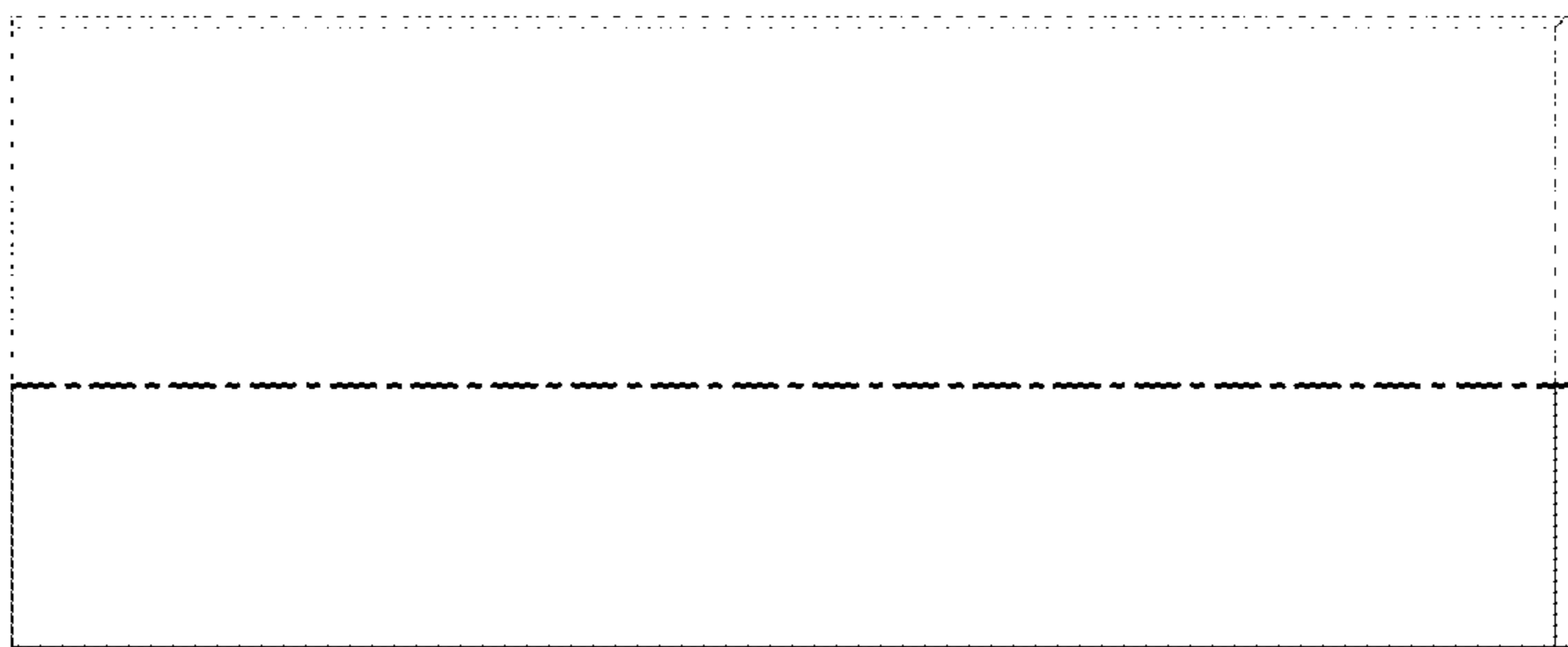

Fig. 23

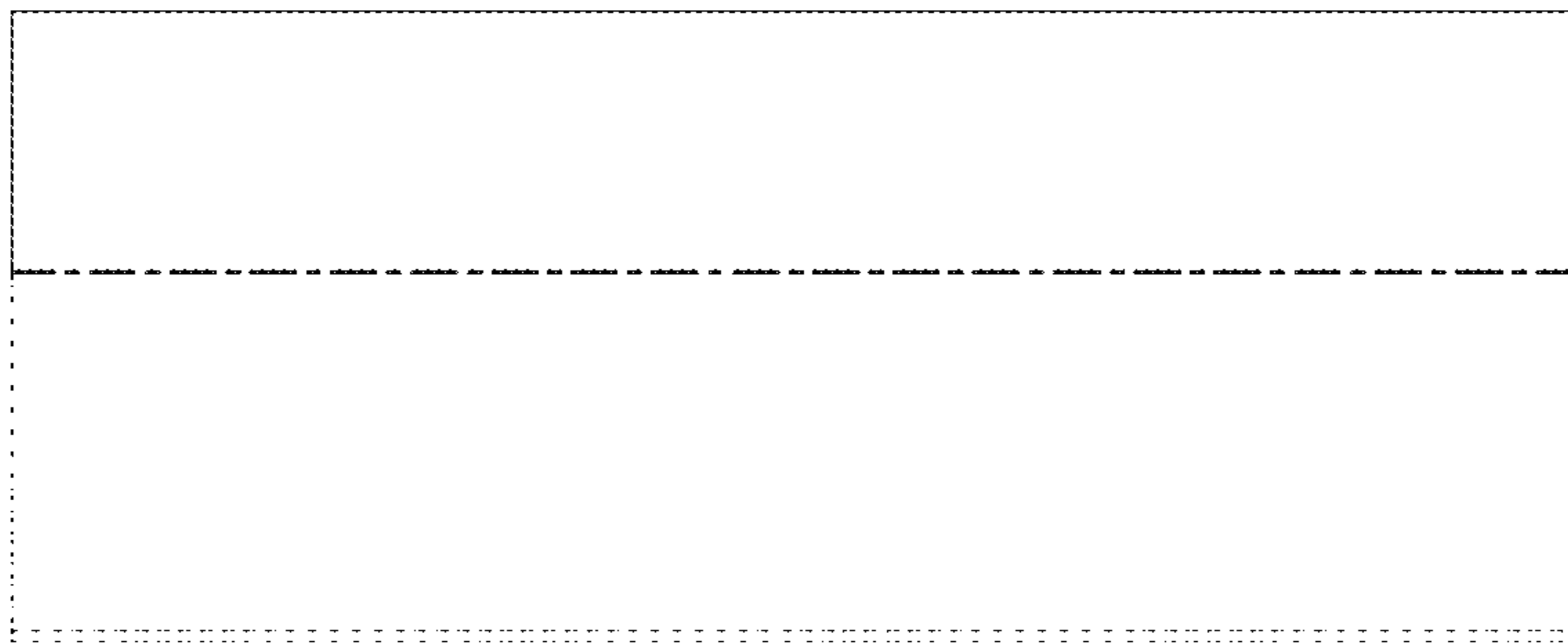

Fig. 24