



US00D751833S

(12) **United States Design Patent**  
**Lv et al.**

(10) **Patent No.:** **US D751,833 S**  
(45) **Date of Patent:** **\*\* Mar. 22, 2016**

(54) **ROCKING BED**

(71) Applicant: **Jarder Outdoor Ningbo Co., Ltd.,**  
Ningbo (CN)  
(72) Inventors: **Zhenxiao Lv, Ningbo (CN); Shifeng**  
**Hu, Ningbo (CN)**  
(73) Assignee: **Jarder Outdoor Ningbo Co., Ltd.,**  
Ningbo (CN)

(\*\*) Term: **14 Years**

(21) Appl. No.: **29/496,962**

(22) Filed: **Jul. 18, 2014**

(51) **LOC (10) Cl.** ..... **06-01**

(52) **U.S. Cl.**  
USPC ..... **D6/348**

(58) **Field of Classification Search**  
USPC ..... D6/334-336, 344, 347, 348, 361, 371,  
D6/373, 375, 376, 716, 716.1, 716.3, 716.4  
CPC ..... A47C 3/02; A47C 3/021; A47C 3/023;  
A47C 3/029; A47C 5/04; A47C 7/282  
See application file for complete search history.

(56) **References Cited**

U.S. PATENT DOCUMENTS

D236,046 S *	7/1975	Ginat .....	D6/348
D291,034 S *	7/1987	Burns .....	D6/348
D357,815 S *	5/1995	Vidal .....	D6/348
D379,270 S *	5/1997	Voyce .....	D6/347
D548,472 S *	8/2007	Habing .....	D6/347
D677,914 S *	3/2013	Cardenas .....	D6/347
D728,949 S *	5/2015	Fang .....	D6/348
D728,950 S *	5/2015	Fang .....	D6/348

\* cited by examiner

*Primary Examiner* — Mimosa De

(74) *Attorney, Agent, or Firm* — Wang Law Firm, Inc.

(57) **CLAIM**

The ornamental design for a rocking bed, as shown and described.

**DESCRIPTION**

FIG. 1 is a right side view of the rocking bed;  
FIG. 2 is a back view thereof;  
FIG. 3 is a front view thereof;  
FIG. 4 is a left side view thereof;  
FIG. 5 is a top plan view thereof; and,  
FIG. 6 is a perspective view from the front-right thereof.

**1 Claim, 6 Drawing Sheets**

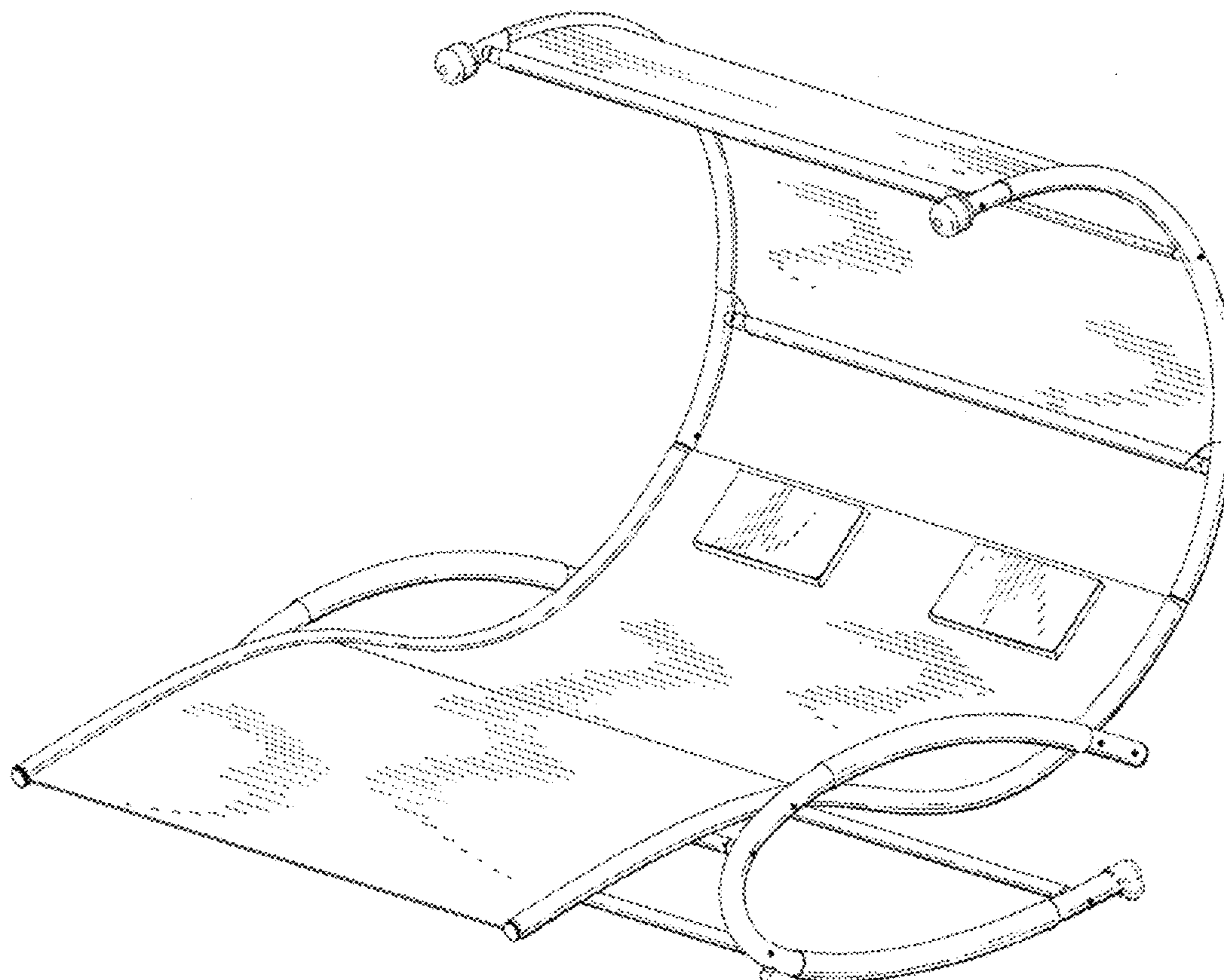

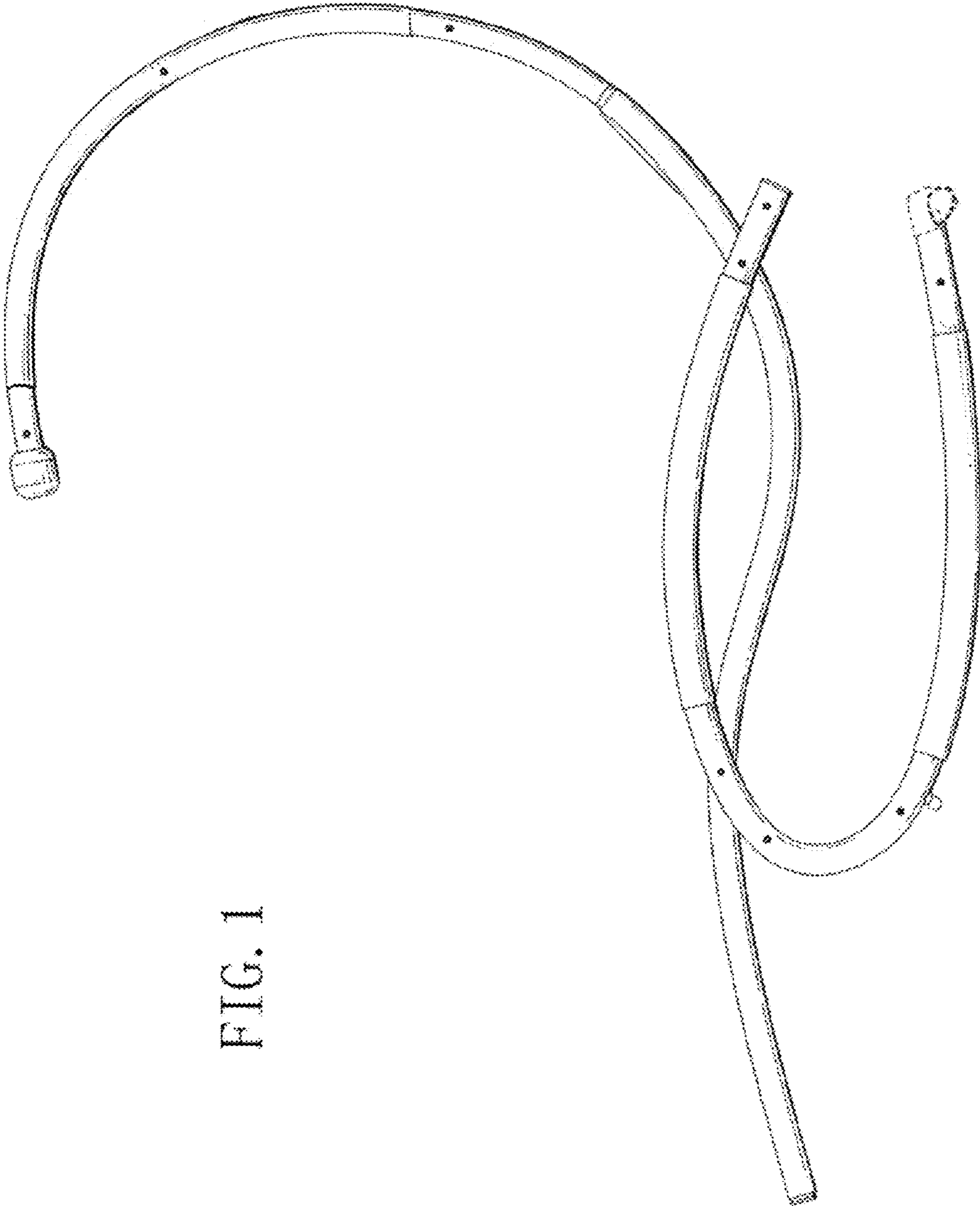

FIG. 1

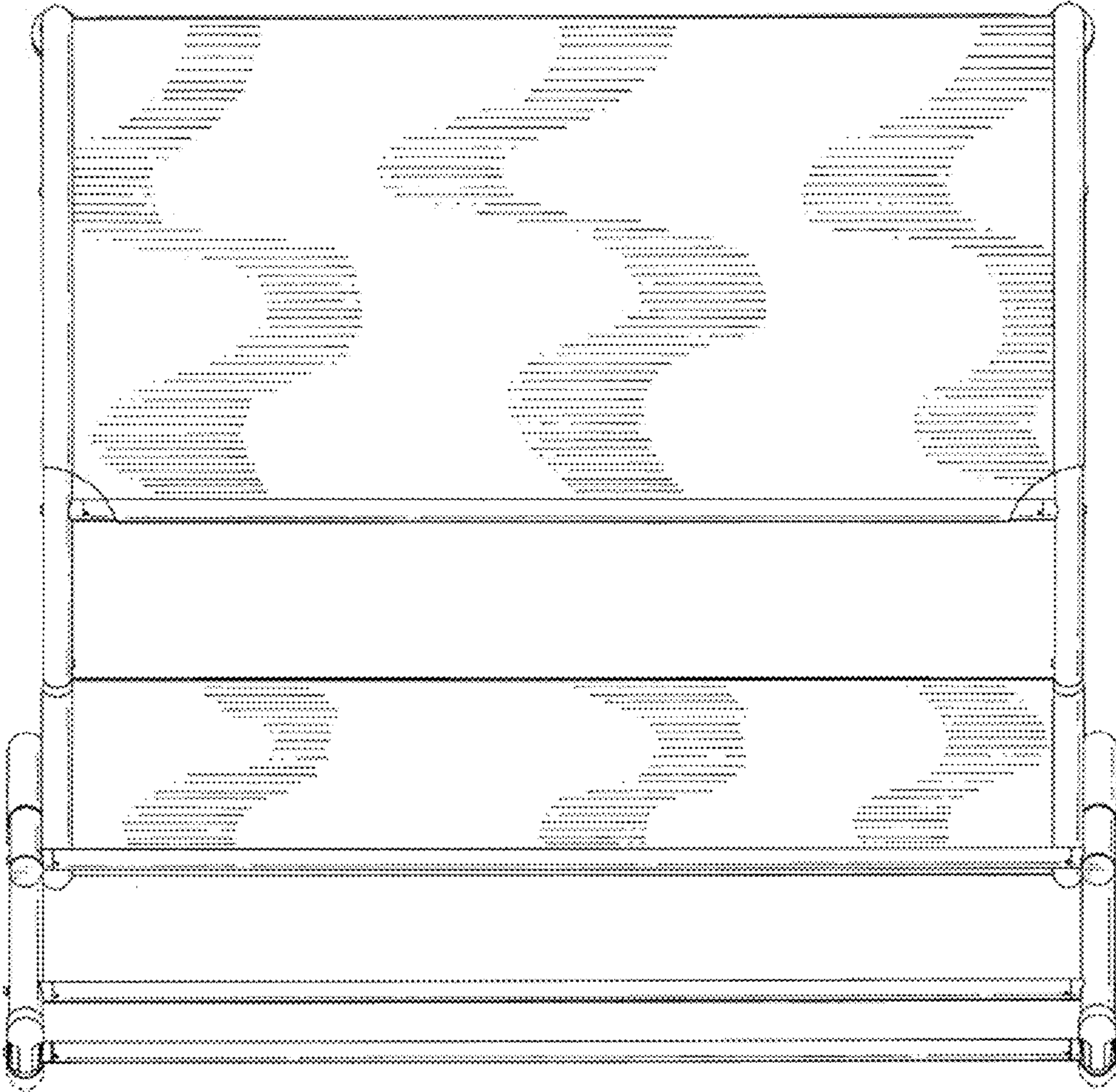

FIG. 2

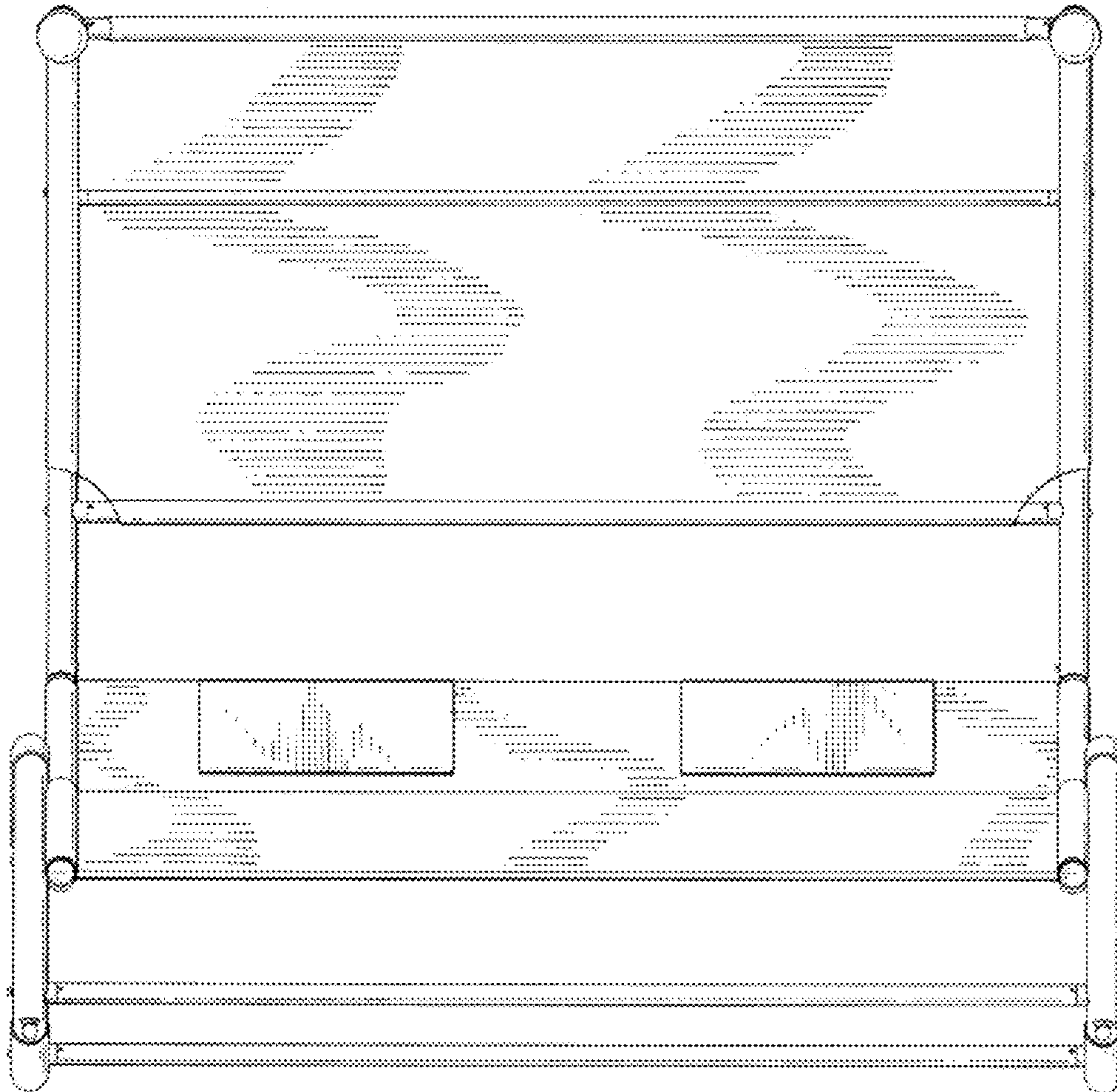
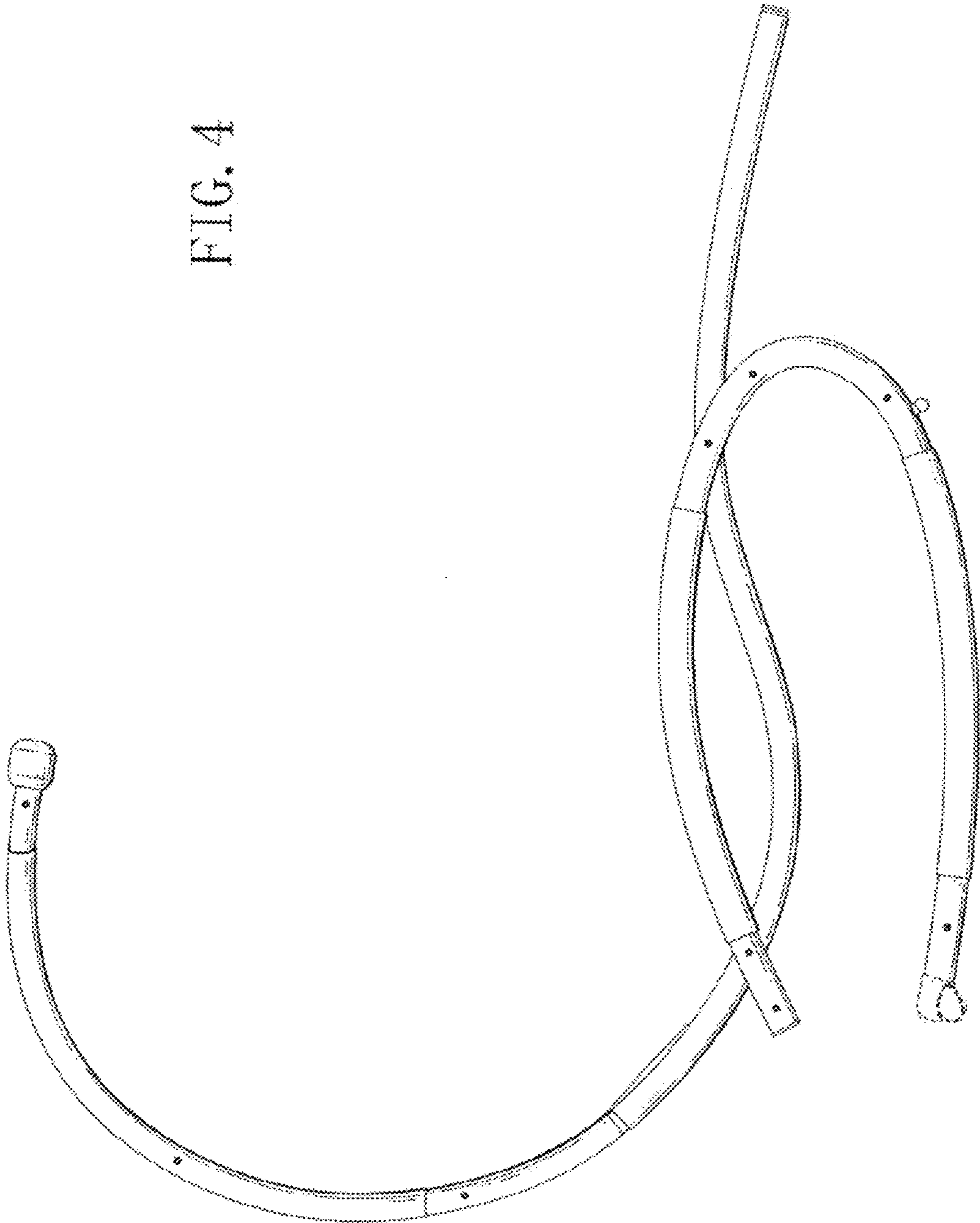

FIG. 3

FIG. 4



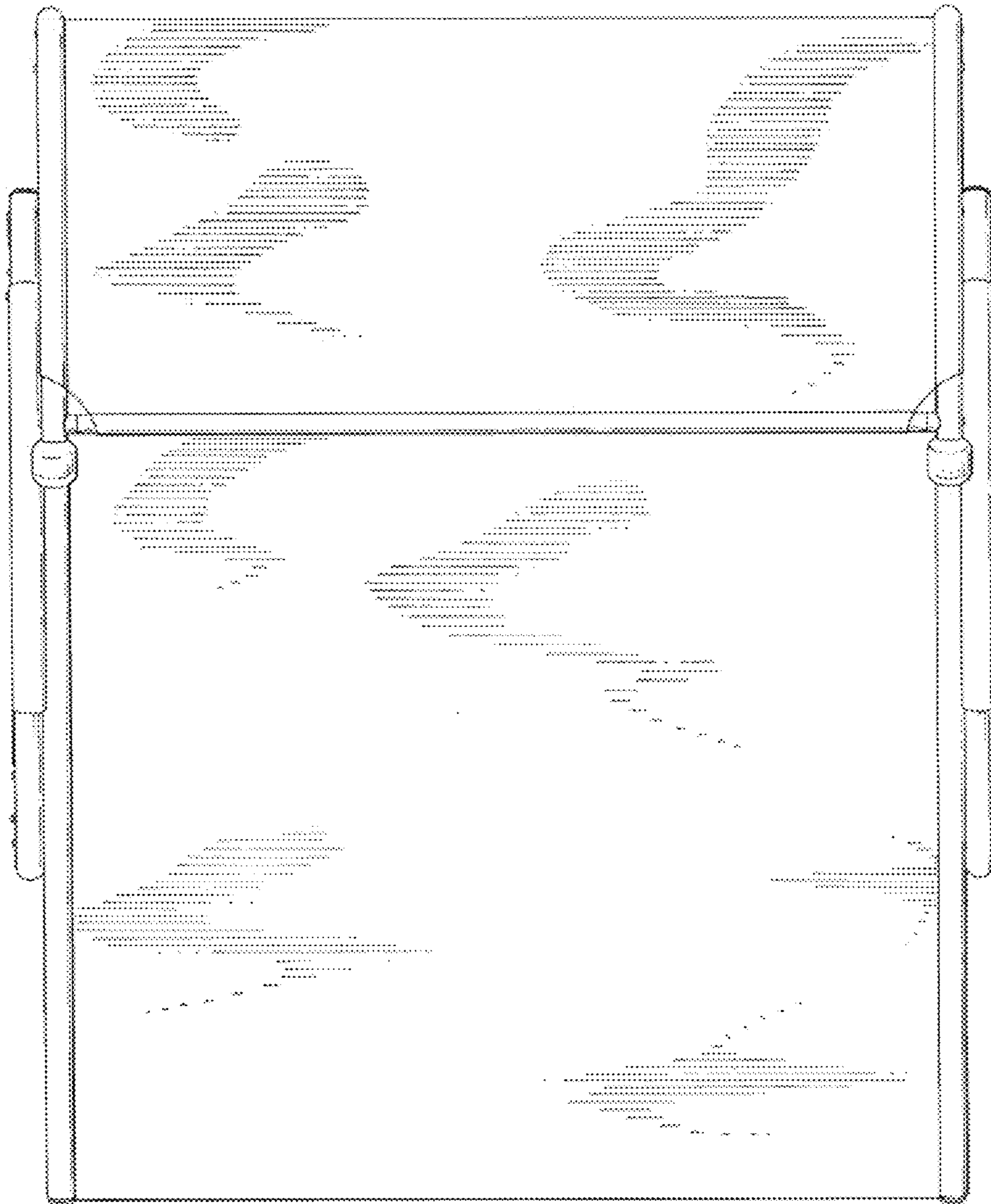

FIG. 5

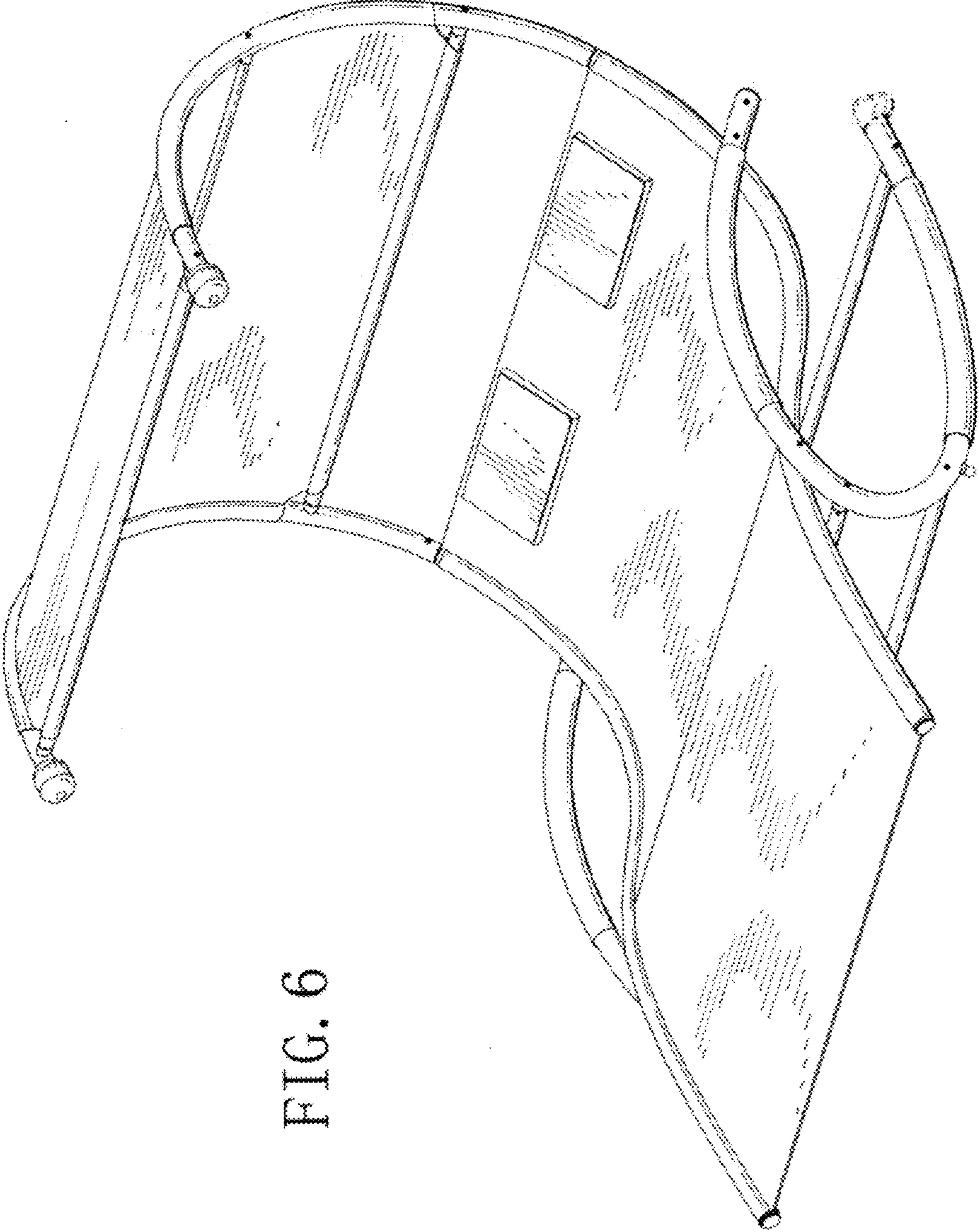

FIG. 6