



US00D751748S

(12) **United States Design Patent**
Guercio et al.

(10) **Patent No.:** **US D751,748 S**
(45) **Date of Patent:** **** Mar. 15, 2016**

- (54) **CANOPY LED LIGHT FIXTURE WITH FINS**
- (71) Applicant: **RAB Lighting Inc.**, Northvale, NJ (US)
- (72) Inventors: **Vincenzo Guercio**, Wallkill, NY (US);
Dan Wang-Munson, Bergenfield, NJ (US); **Jiang Hu**, Ningbo (CN)
- (73) Assignee: **RAB Lighting Inc.**, Northvale, NJ (US)
- (**) Term: **14 Years**
- (21) Appl. No.: **29/524,652**
- (22) Filed: **Apr. 22, 2015**

Related U.S. Application Data

- (63) Continuation-in-part of application No. 29/507,307, filed on Oct. 27, 2014.
- (51) **LOC (10) Cl.** **26-03**
- (52) **U.S. Cl.**
USPC **D26/89**
- (58) **Field of Classification Search**
USPC D26/72, 85, 89, 118, 120
CPC F21S 8/03; F21S 8/033; F21S 8/04;
F21S 8/043; F21V 3/04; F21V 3/0418;
F21V 3/0427; F21V 3/0436; F21V 3/0445;
F21V 21/02; F21V 21/03; F21V 29/506;
F21V 3/049; F21V 5/045; F21V 7/04; F21V
11/06
See application file for complete search history.

References Cited

U.S. PATENT DOCUMENTS

- D211,820 S 7/1968 Pettengill
 - D212,899 S 12/1968 Vesely et al.
- (Continued)

FOREIGN PATENT DOCUMENTS

TW D105607 7/2005

Primary Examiner — Clare E Heflin
(74) *Attorney, Agent, or Firm* — SmithAmundsen LLC;
Kelly J. Smith; Dennis S. Schell

(57) **CLAIM**

The ornamental design for a canopy LED light fixture with fins, as shown and described.

DESCRIPTION

FIG. 1 is a top perspective view according to a first embodiment of the new design;
 FIG. 2 is a bottom perspective view according to the first embodiment;
 FIG. 3 is a bottom view according to the first embodiment;
 FIG. 4 is a left view according to the first embodiment;
 FIG. 5 is a front side view according to the first embodiment;
 FIG. 6 is a top view according to the first embodiment;
 FIG. 7 is a top perspective view according to a second embodiment of the new design;
 FIG. 8 is a bottom perspective view according to the second embodiment;
 FIG. 9 is a bottom view according to the second embodiment;
 FIG. 10 is a left view according to the second embodiment;
 FIG. 11 is a front side view according to the second embodiment; and,
 FIG. 12 is a top view according to the second embodiment.
 The broken lines shown in the drawings are for the purpose of illustrating portions of the article that form no part of the claimed design. The right side view of the first embodiment is a mirror image of the left side view of the first embodiment, and the rear view of the first embodiment is a mirror image of the front view of the first embodiment. Similarly, the right side view of the second embodiment is a mirror image of the left side view of the second embodiment, and the rear view of the second embodiment is a mirror image of the front view of the second embodiment. As such, these mirror image views are omitted.

1 Claim, 10 Drawing Sheets

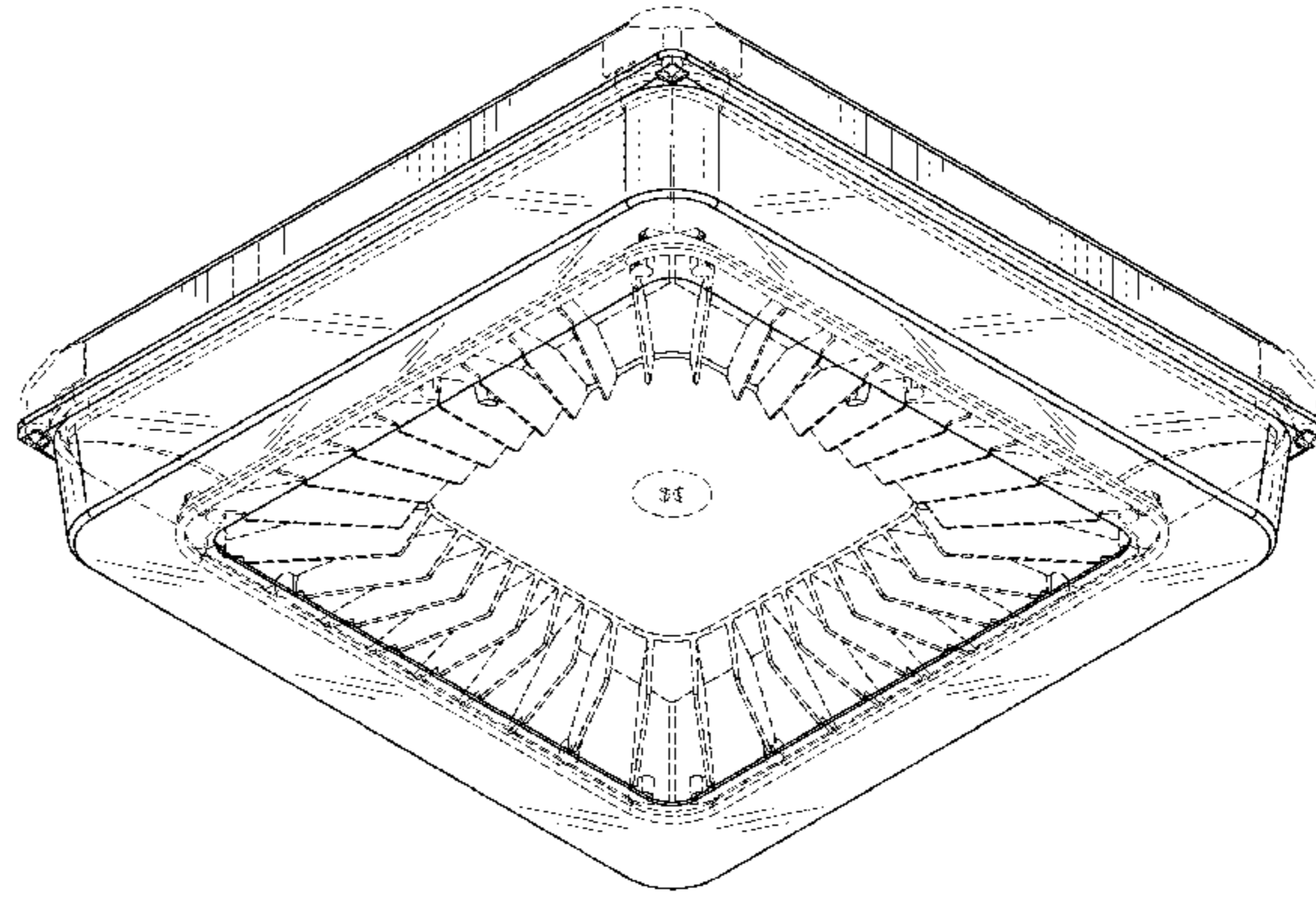
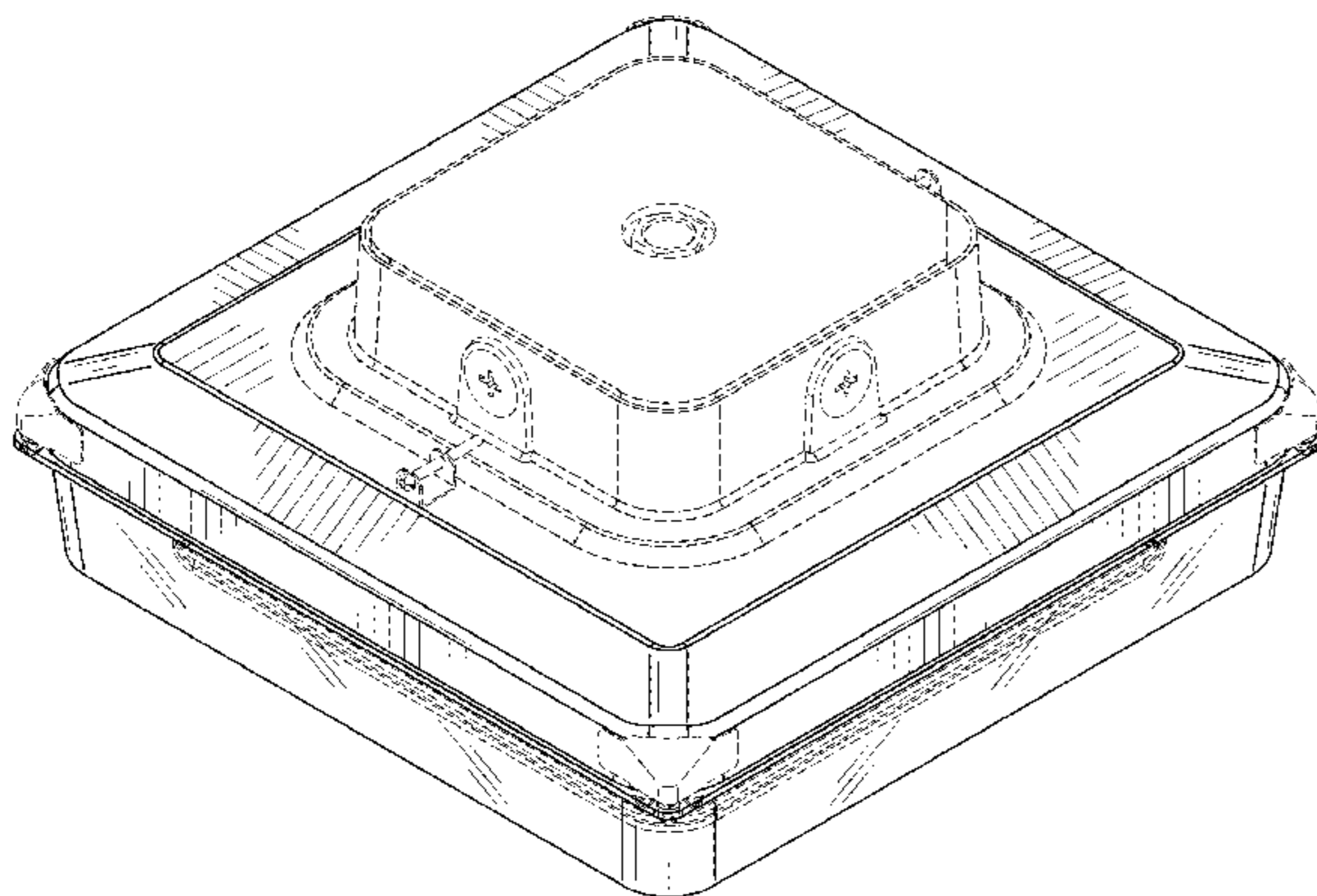

(56)

References Cited

U.S. PATENT DOCUMENTS

D221,181 S 7/1971 Bobrick
 D221,351 S 8/1971 Remington
 3,671,739 A 6/1972 McCain
 4,827,386 A 5/1989 Mackiewicz
 D308,423 S * 6/1990 Galipeau D26/67
 5,228,773 A 7/1993 Win
 D444,903 S 7/2001 Wang
 6,394,628 B1 5/2002 Wang
 7,152,997 B1 * 12/2006 Kovacik F21V 21/06
 362/191
 D551,379 S * 9/2007 Maxik D26/74
 D579,138 S 10/2008 Ghini
 7,572,038 B2 * 8/2009 Kinnune F21V 21/02
 248/318
 7,780,318 B2 8/2010 Xiao et al.
 D624,686 S 9/2010 Toney, Jr. et al.
 D629,146 S * 12/2010 van den Akker D26/89
 D634,055 S 3/2011 Hokazono et al.
 D640,821 S * 6/2011 Kocks D26/89
 D641,908 S 7/2011 McKee
 D655,853 S 3/2012 Kim et al.

8,215,799 B2 * 7/2012 Vanden Eynden F21V 15/01
 362/218
 8,220,961 B2 * 7/2012 Belknap F21V 3/00
 362/240
 D667,587 S * 9/2012 Wilcox D26/89
 8,292,448 B2 * 10/2012 Kim F21S 2/005
 362/311.02
 8,297,798 B1 10/2012 Pittman et al.
 D676,592 S * 2/2013 Salessi D26/89
 8,382,340 B2 * 2/2013 Boyer F21S 8/02
 362/147
 8,465,178 B2 * 6/2013 Wilcox F21V 19/0055
 362/294
 D702,393 S 4/2014 Ansierowicz et al.
 D703,861 S * 4/2014 Holland D26/89
 D722,194 S * 2/2015 Guercio D26/89
 D722,195 S * 2/2015 Highbridge D26/89
 D730,570 S * 5/2015 Chen D26/128
 D731,111 S * 6/2015 Chen D26/128
 9,121,554 B2 * 9/2015 Shimizu F21K 9/50
 2008/0278957 A1 * 11/2008 Pickard F21S 8/02
 362/373
 2011/0026249 A1 2/2011 Wylde et al.
 2011/0110081 A1 5/2011 Belknap et al.

* cited by examiner

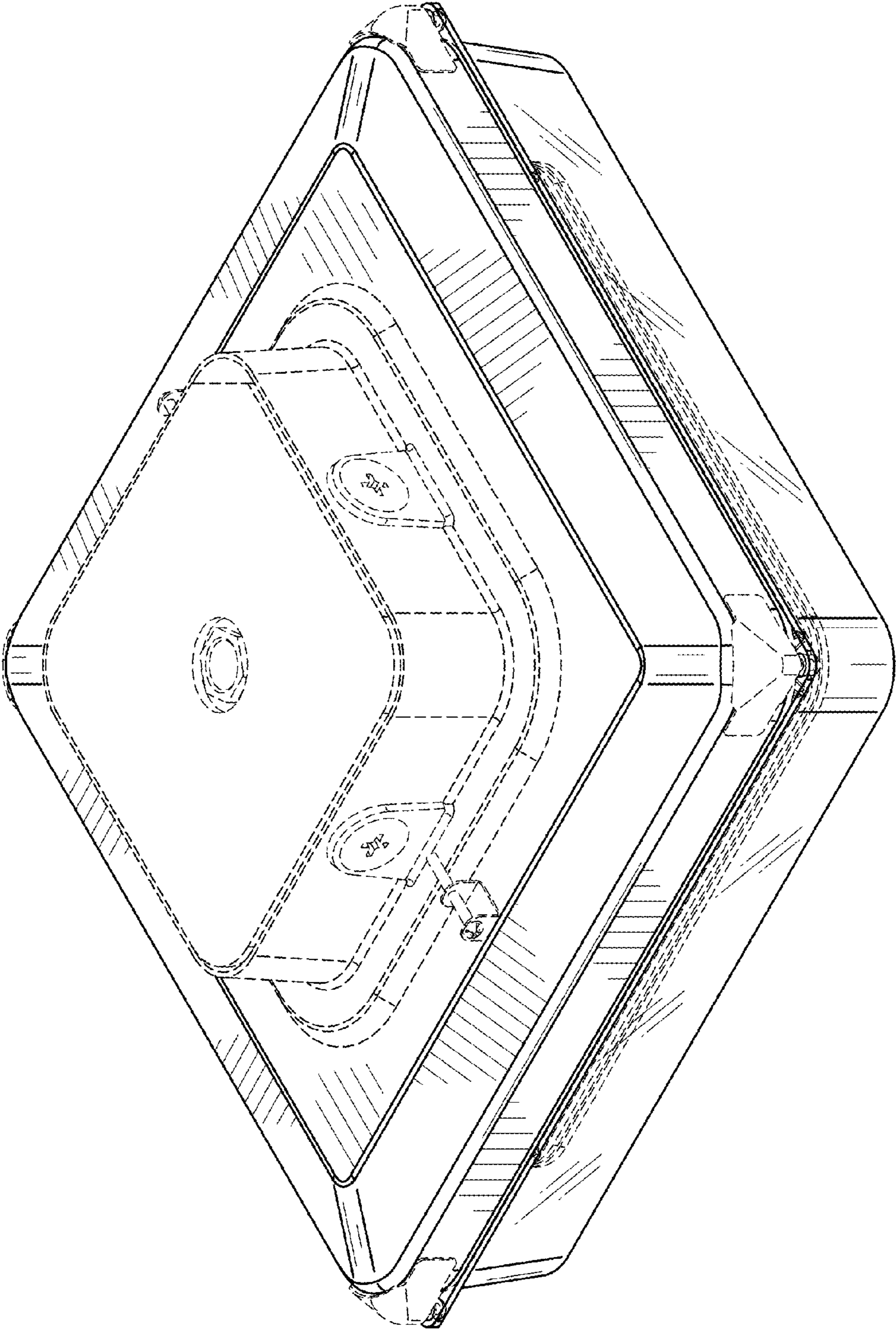

FIG. 1

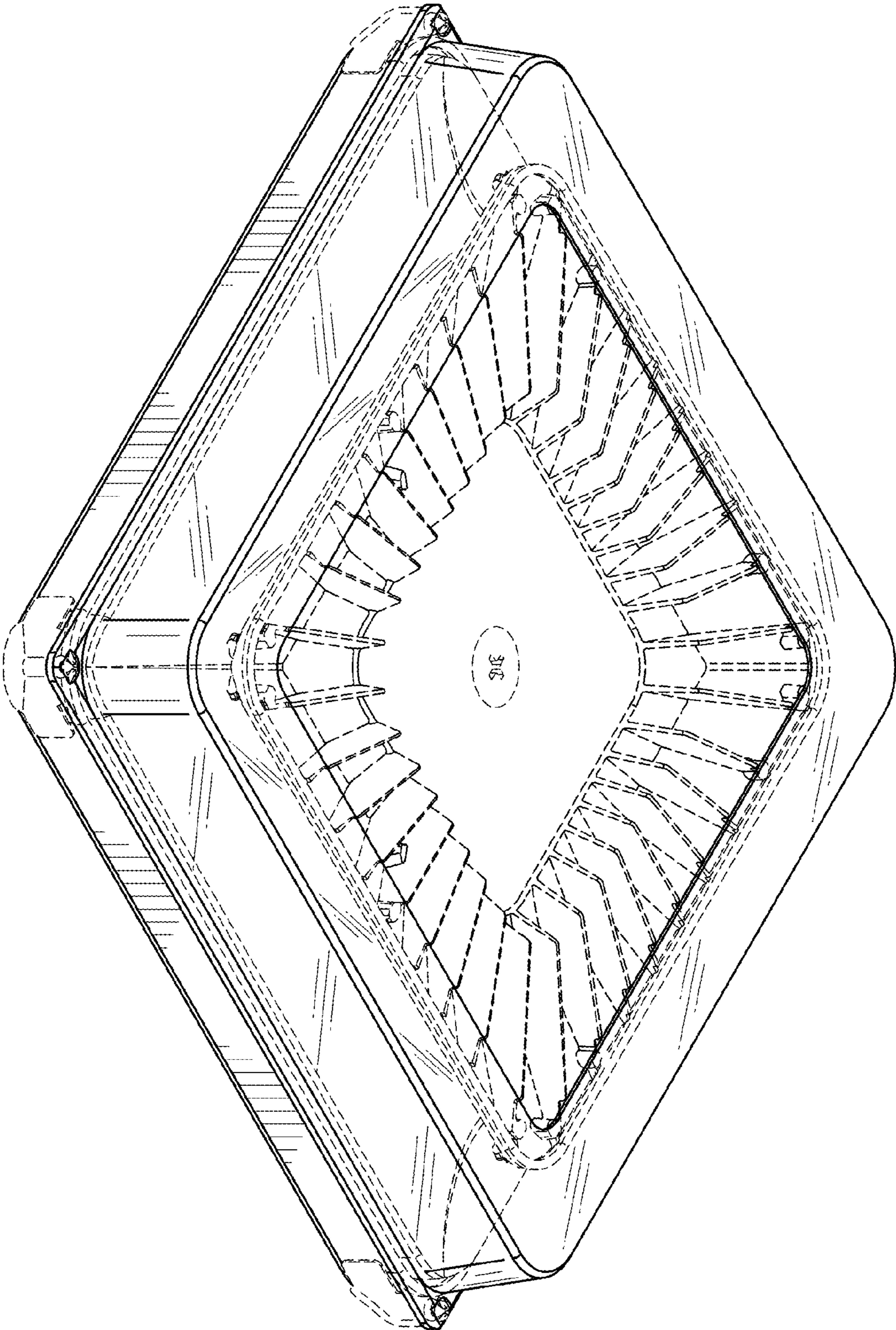

FIG. 2

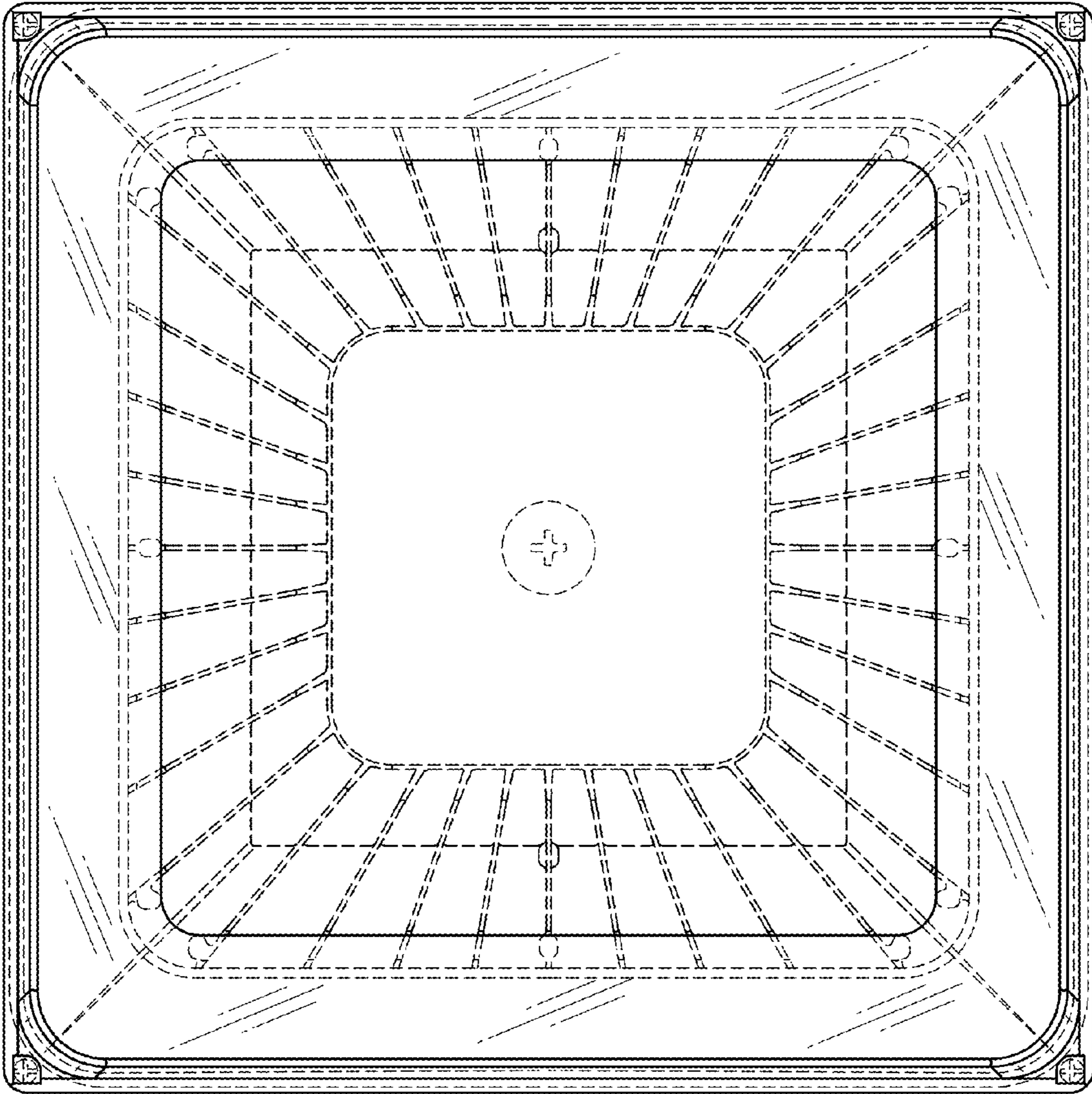

FIG. 3

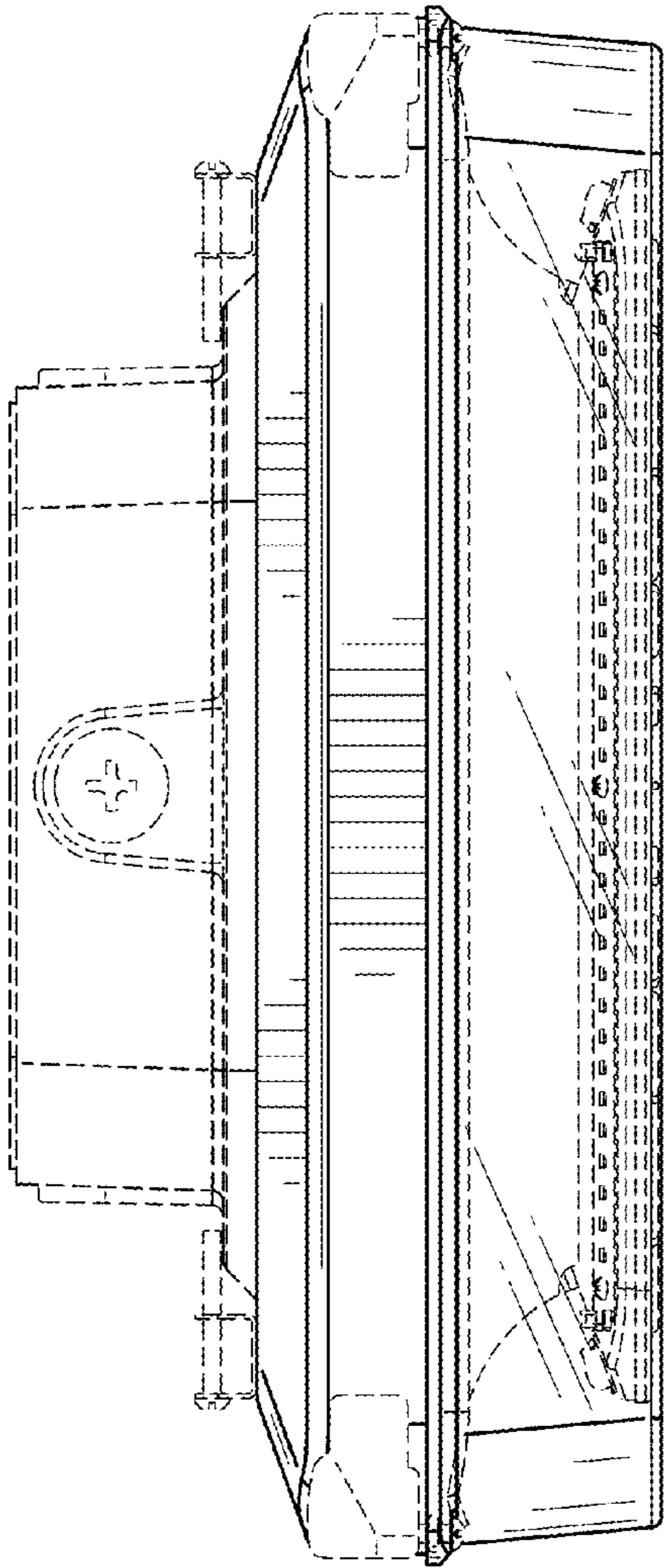

FIG. 4

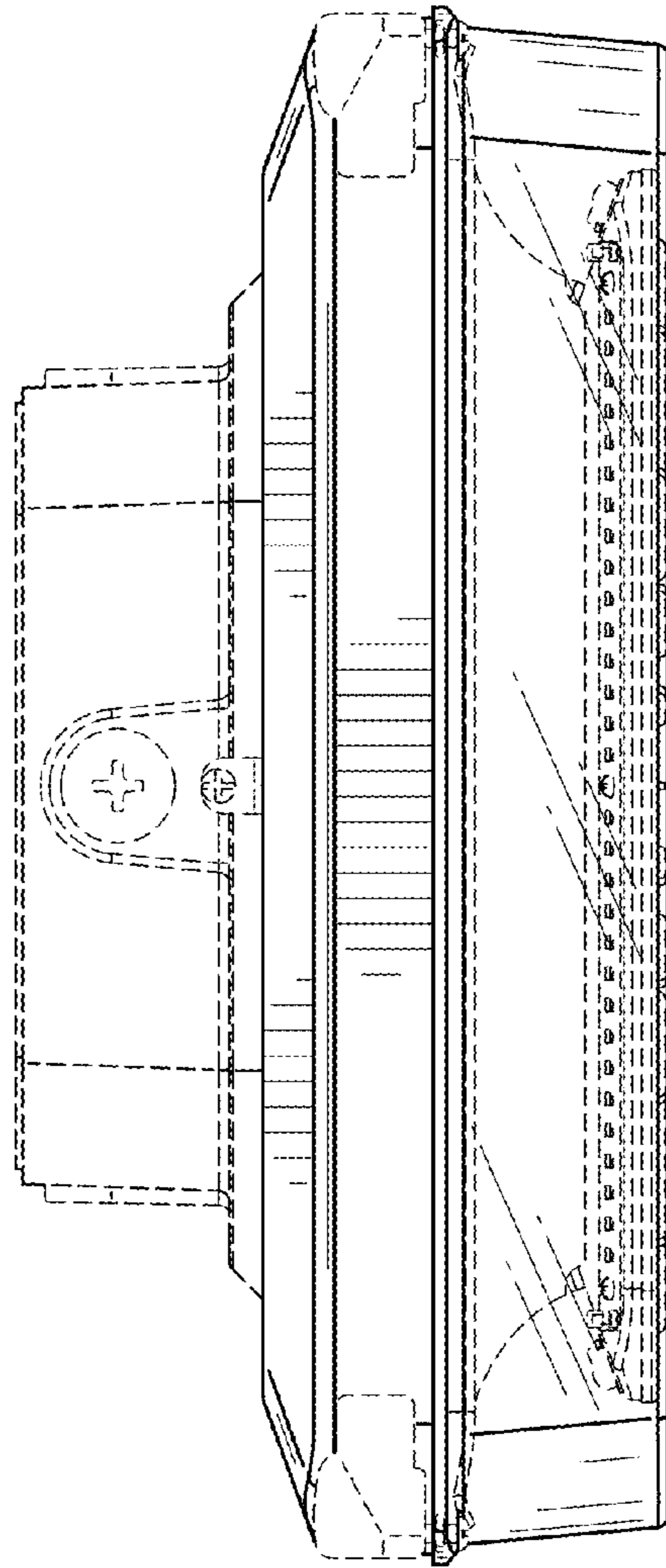

FIG. 5

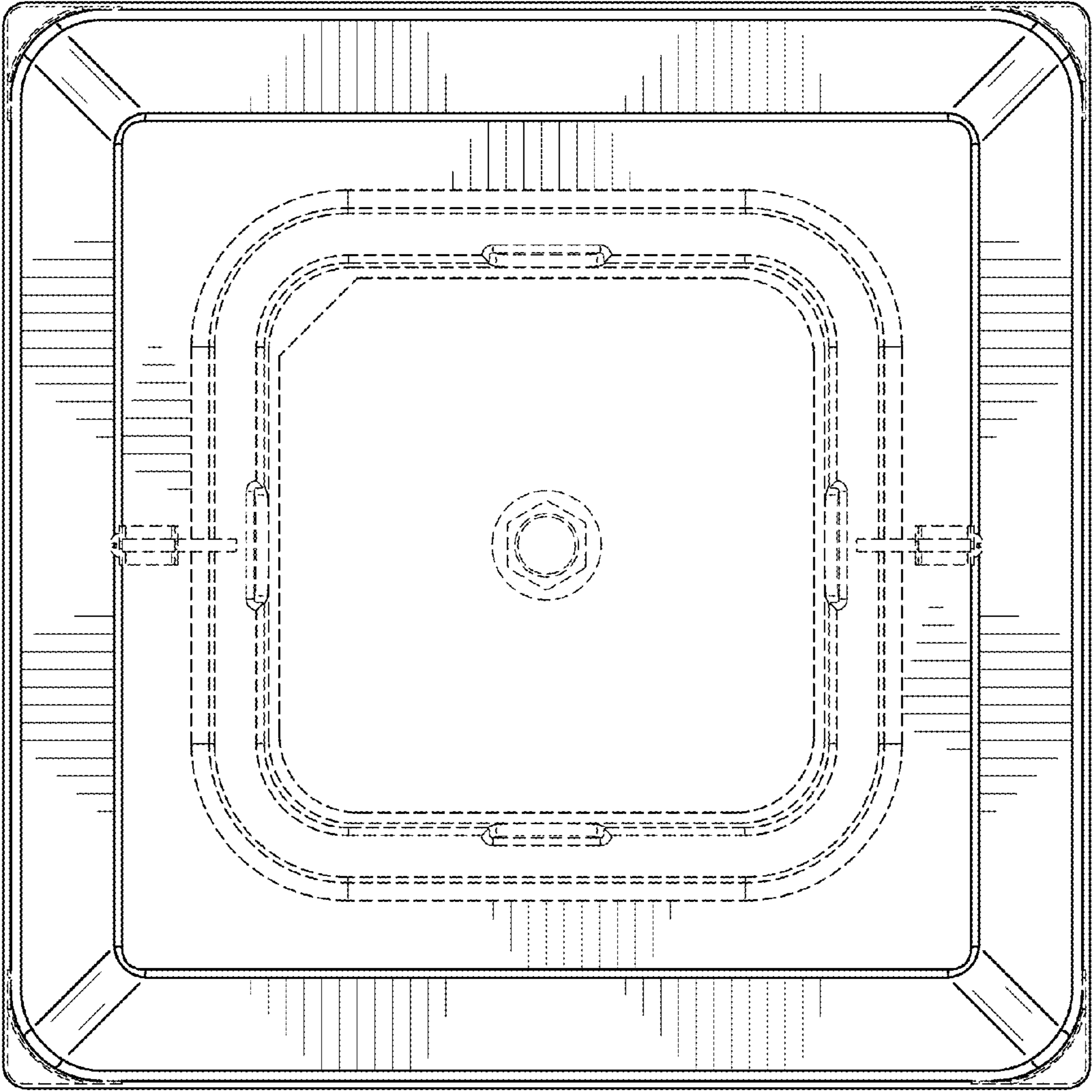

FIG. 6

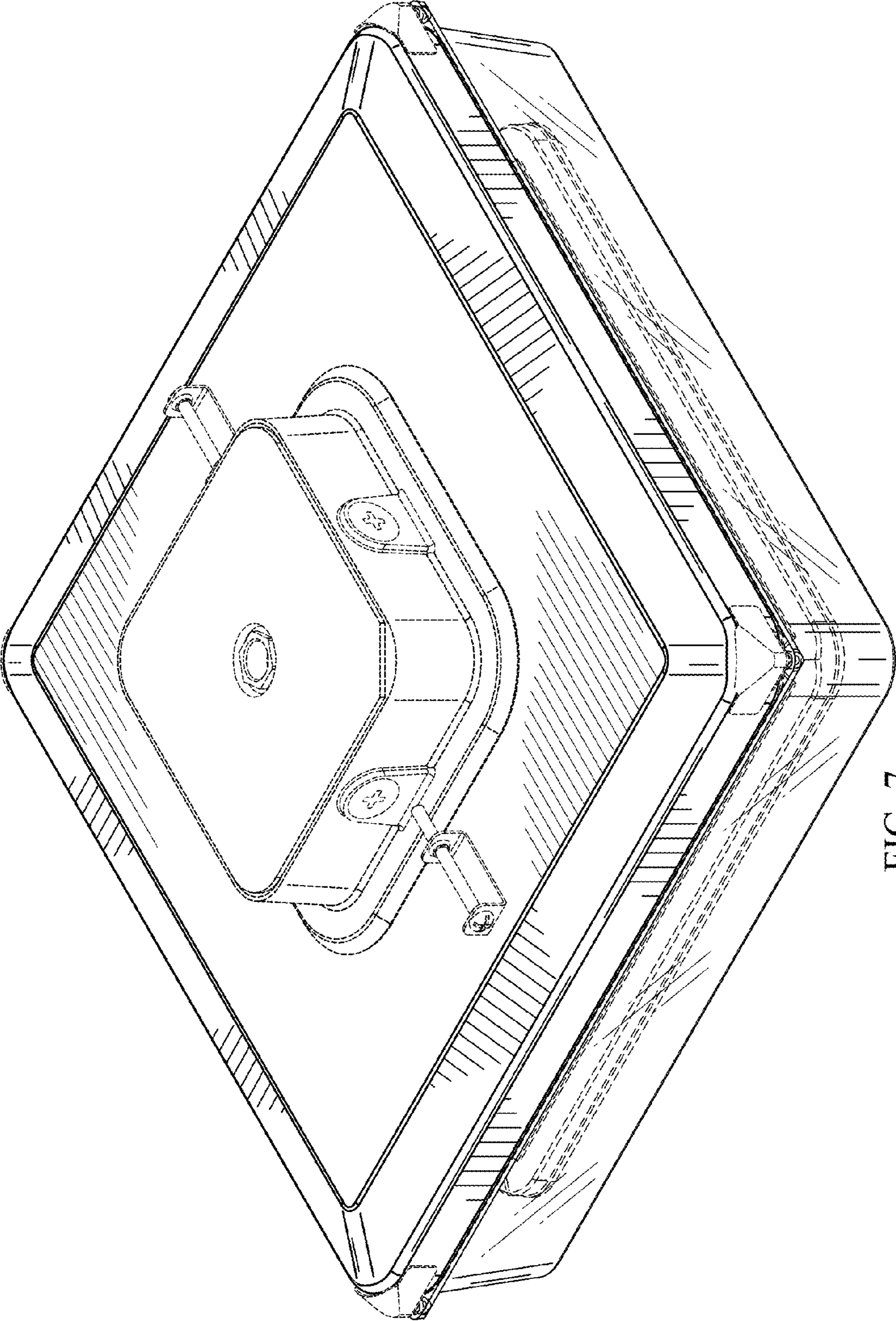

FIG. 7

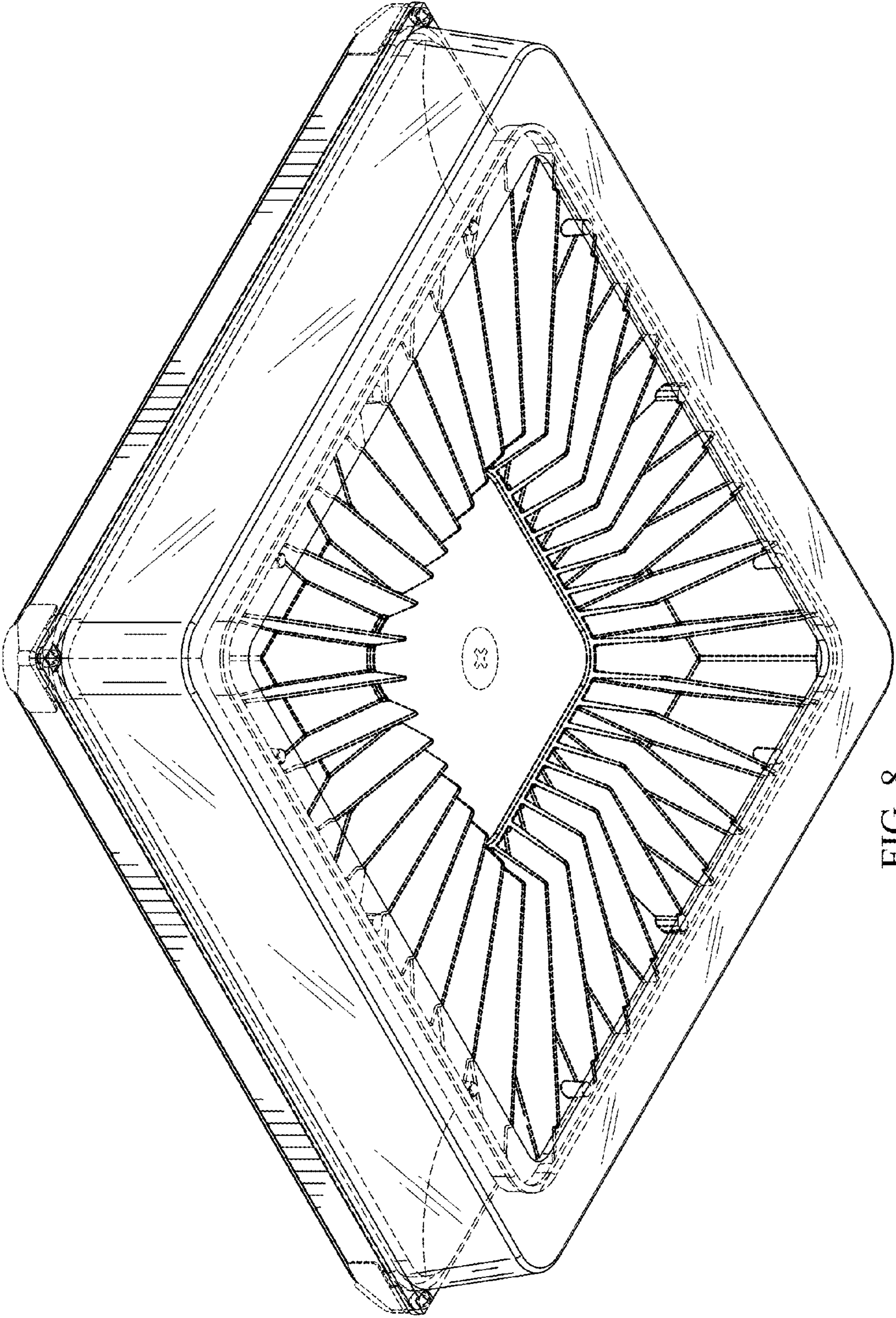
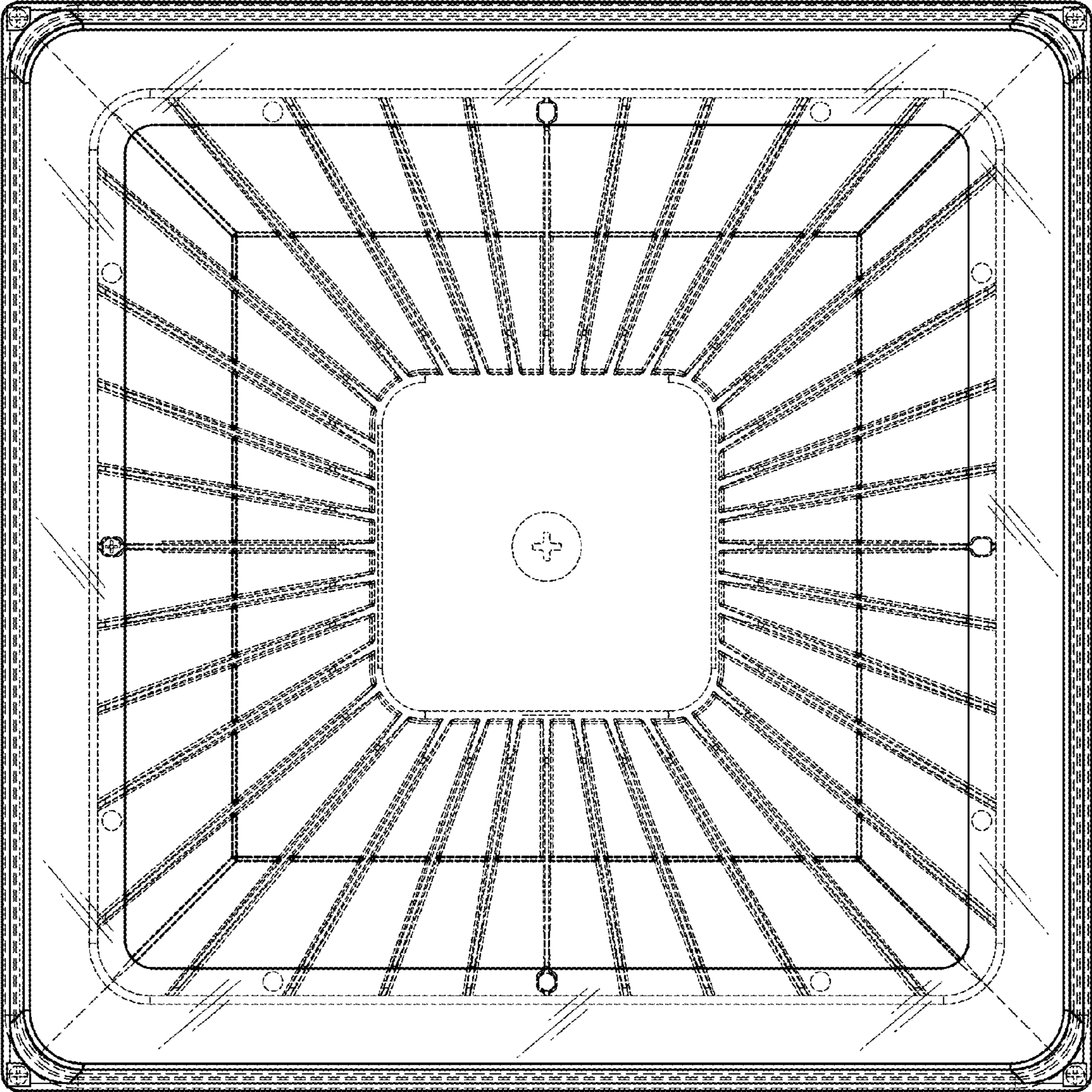

FIG. 8

FIG. 9



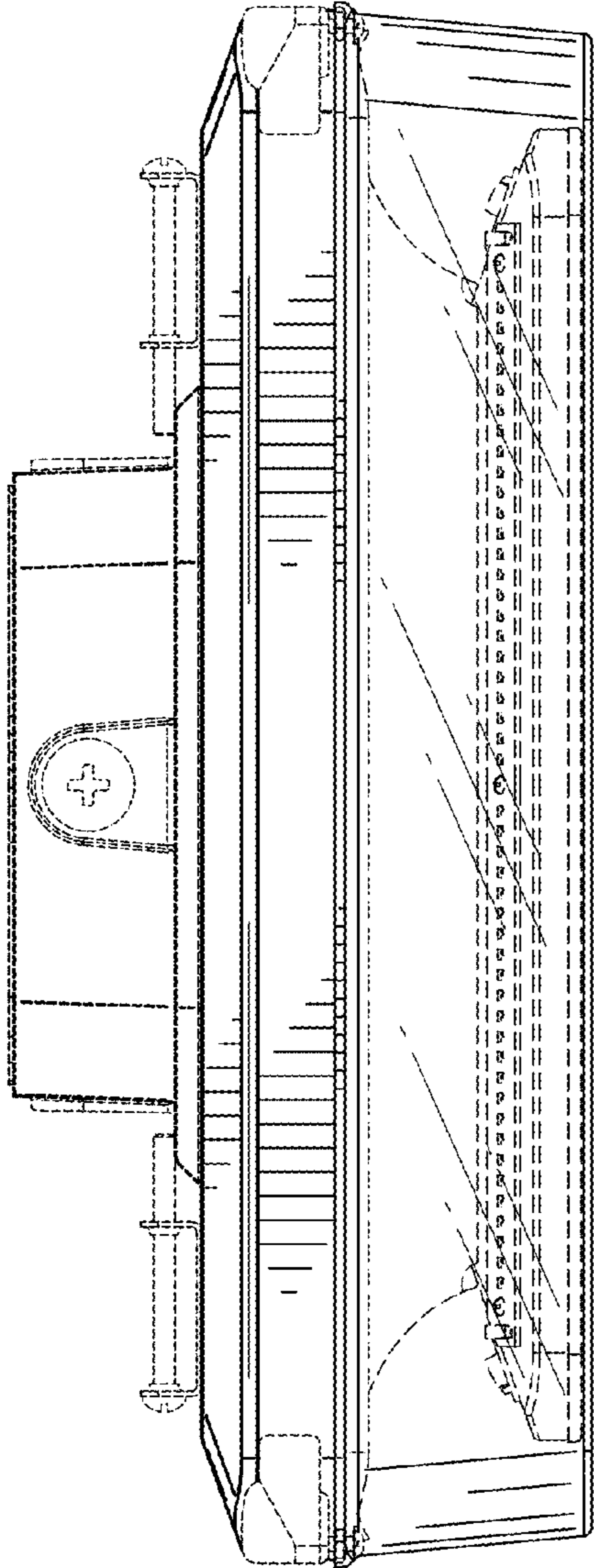

FIG. 10

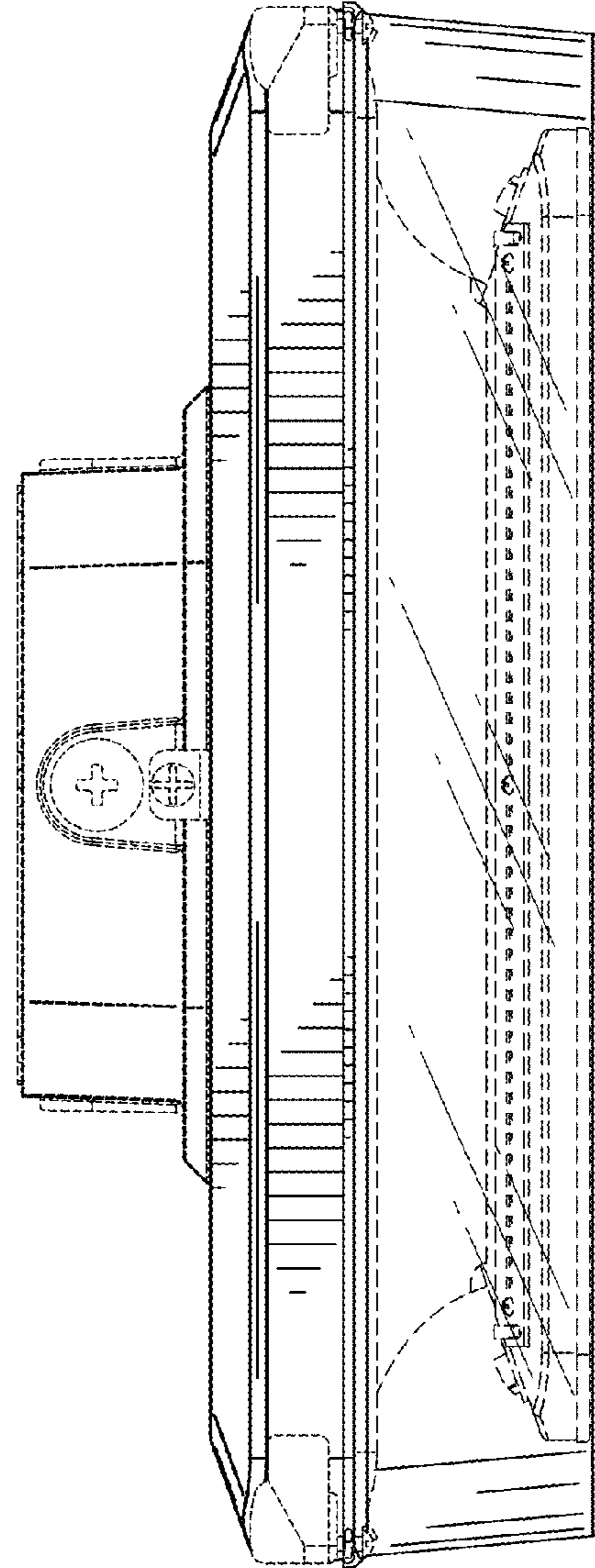

FIG. 11

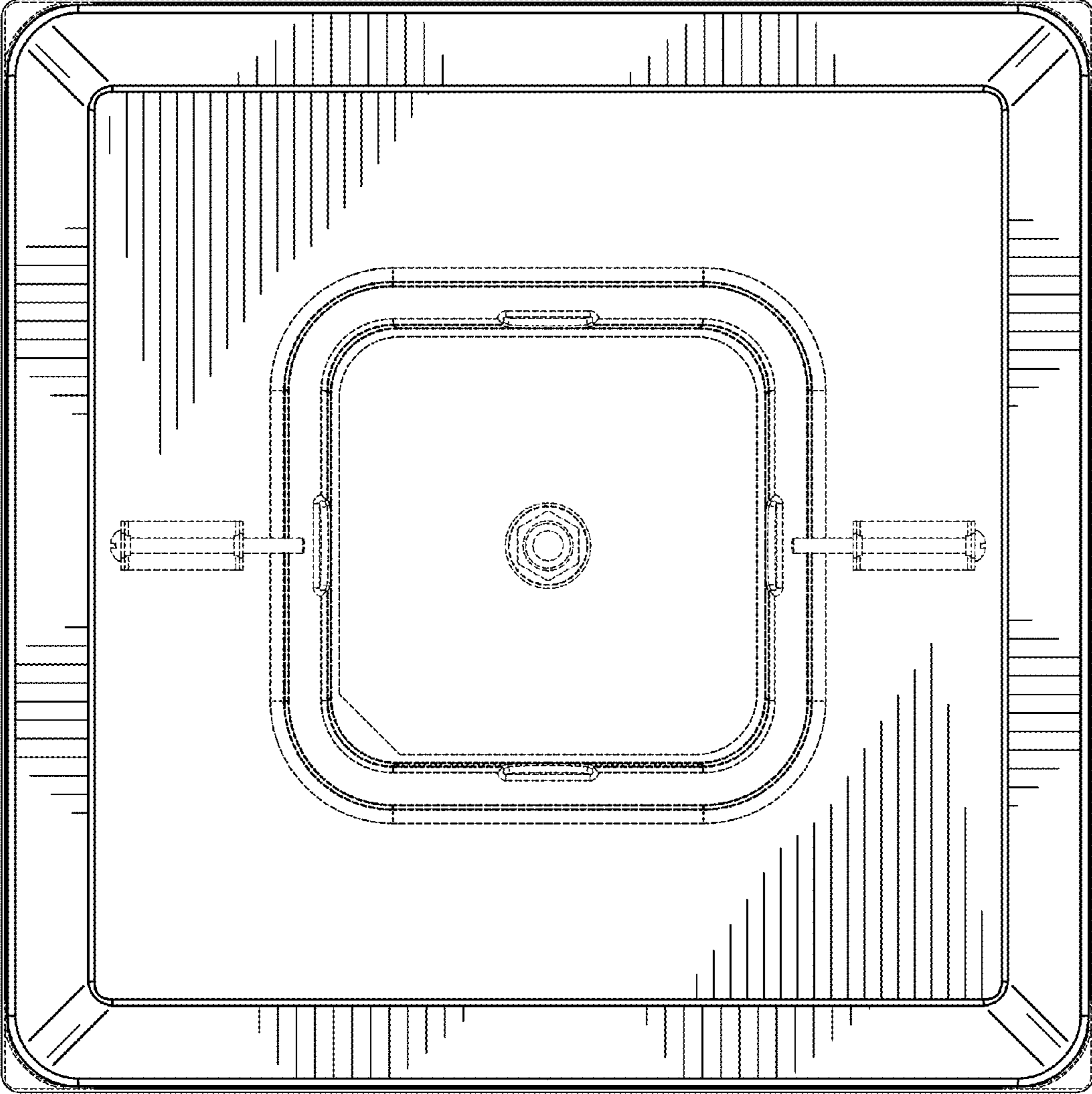

FIG. 12