



US00D751729S

(12) **United States Design Patent**  
**Le Clair**

(10) **Patent No.:** **US D751,729 S**  
(45) **Date of Patent:** **\*\* \*Mar. 15, 2016**

(54) **COMBINED FENCE POST AND ROLLER**

*Primary Examiner* — Doris Clark

(76) Inventor: **Gerald Joseph Le Clair**, W. Melbourne, FL (US)

(74) *Attorney, Agent, or Firm* — Mark Malek; Widerman Malek, PL

(\*) Notice: This patent is subject to a terminal disclaimer.

(57) **CLAIM**  
The ornamental design for a combined fence post and roller, as shown and described.

(\*\*) Term: **14 Years**

**DESCRIPTION**

(21) Appl. No.: **29/365,048**

FIG. 1 is a front view of a combined fence post and roller according to the present invention.

(22) Filed: **Jul. 1, 2010**

FIG. 2 is a rear view of the combined fence post and roller illustrated in FIG. 1.

(51) **LOC (10) Cl.** ..... **25-02**

FIG. 3 is a left side view of the combined fence post and roller illustrated in FIG. 1.

(52) **U.S. Cl.**

USPC ..... **D25/38.1**

FIG. 4 is a right side view of the combined fence post and roller illustrated in FIG. 1.

(58) **Field of Classification Search**

USPC ..... D25/46, 38, 45, 39, 38.1; 256/24, 19, 256/73, 21, 3, 12

FIG. 5 is a top view of the combined fence post and roller illustrated in FIG. 1.

See application file for complete search history.

FIG. 6 is a bottom view of the combined fence post and roller illustrated in FIG. 1; and,

(56) **References Cited**

FIG. 7 is a perspective view of the combined fence post and roller illustrated in FIG. 1.

**U.S. PATENT DOCUMENTS**

259,654	A *	6/1882	Worthington	.....	256/12
4,270,736	A *	6/1981	Burch	.....	256/12
4,739,970	A *	4/1988	Francis	.....	256/12
5,143,354	A *	9/1992	Nolan	.....	256/12
D402,041	S *	12/1998	Hill	.....	D25/38.1
D429,342	S *	8/2000	Binns	.....	D25/46
6,102,375	A *	8/2000	Colless et al.	.....	256/26
D450,855	S *	11/2001	Schlichting	.....	D25/38.1
6,585,233	B1 *	7/2003	Sorben	.....	256/12
2005/0189529	A1 *	9/2005	Humphreys et al.	.....	256/12

“Fence with roller” addresses the problem of intruders crossing ordinarily constructed fence with a flat surface and rigid top. Fence with roller prevents passage over the top by denying an intruder a hand hold with which he may scale the fence. Any attempt to cross over the top of the fence results in futilely spinning the freely drum at the top of the fence. A hand hold is impossible and therefore the fence is impassable. The broken lines in FIGS. 1, 2, 6 and 7 represent an unclaimed fence portion of the fence system that forms no part of the claimed invention.

\* cited by examiner

**1 Claim, 4 Drawing Sheets**

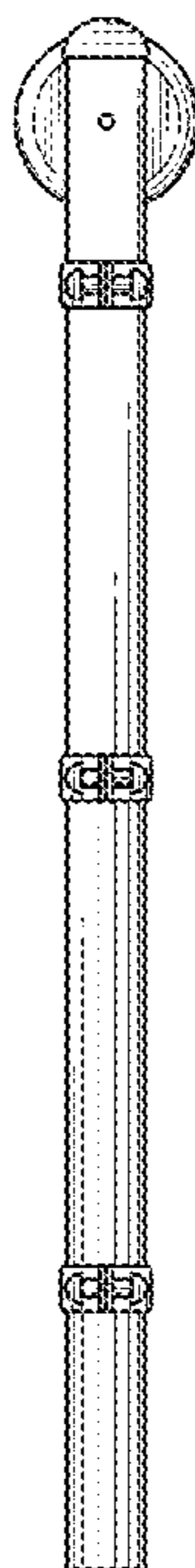



FIG. 1



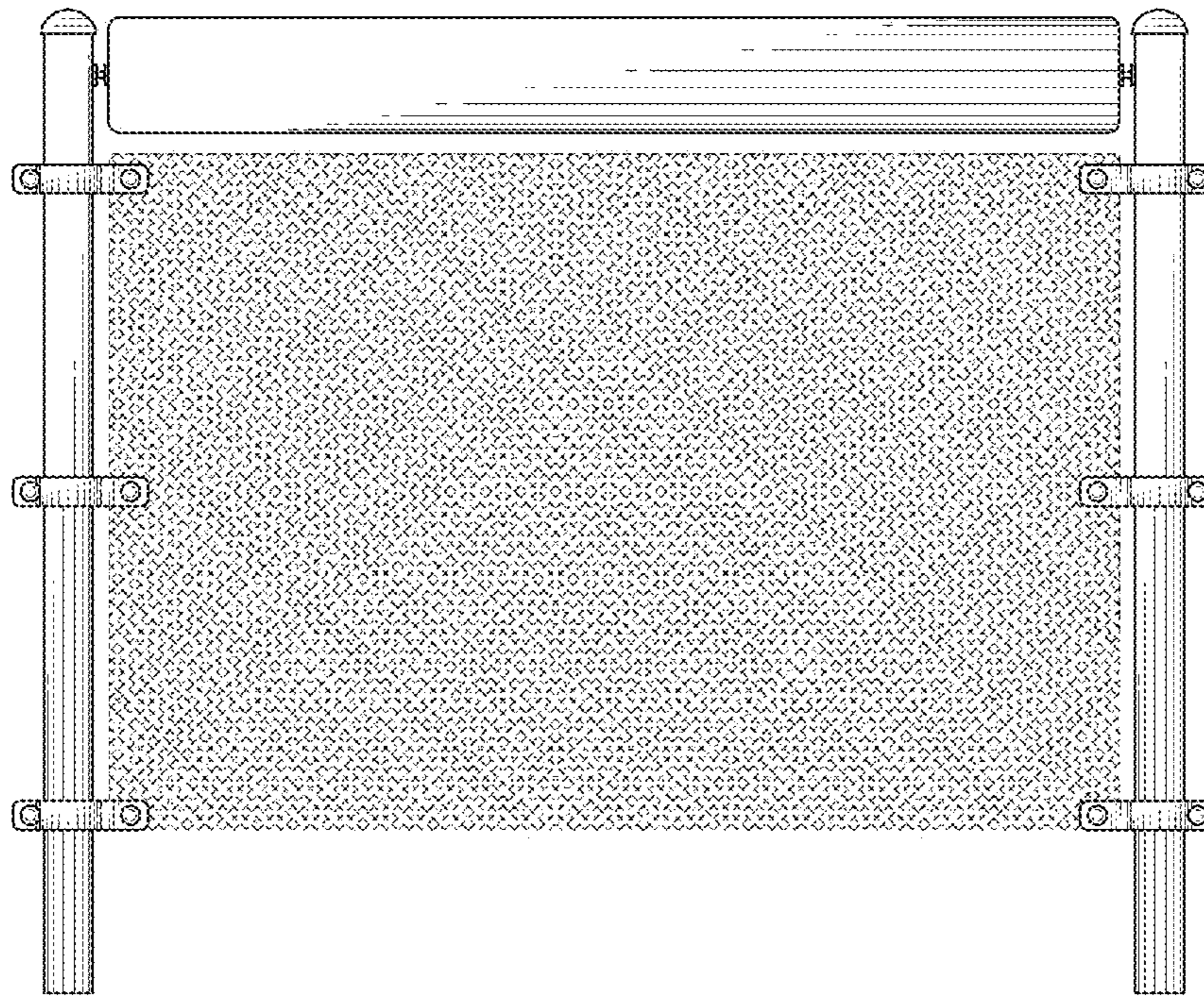

FIG. 2

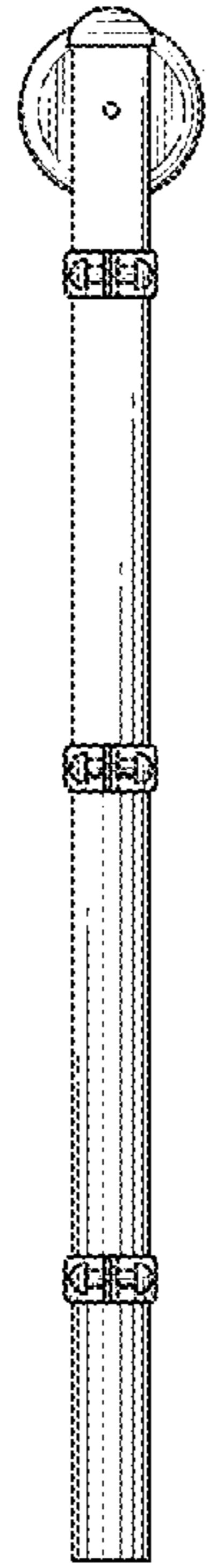

FIG. 3

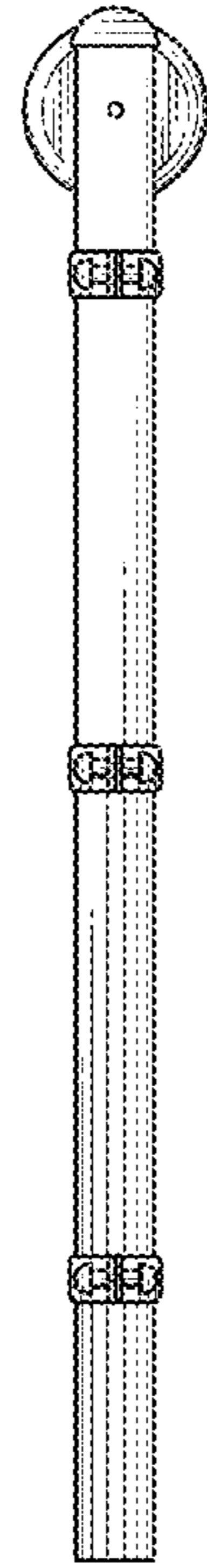

FIG. 4

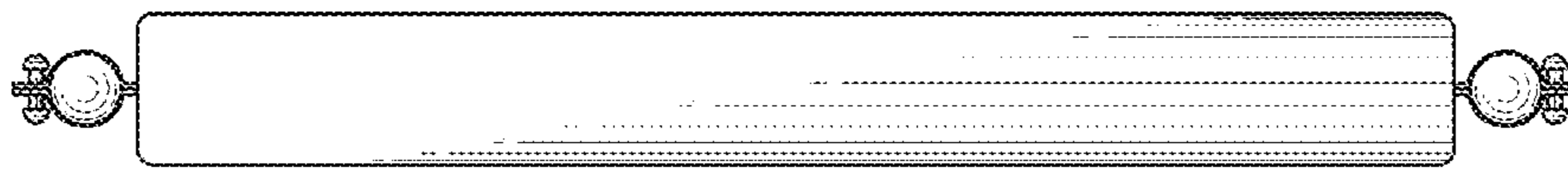

FIG. 5

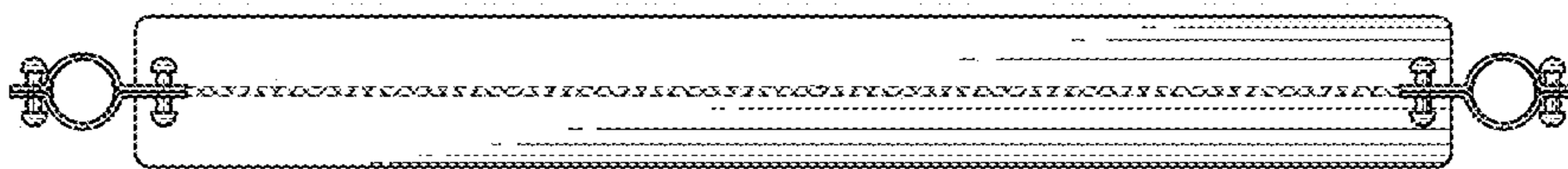

FIG. 6



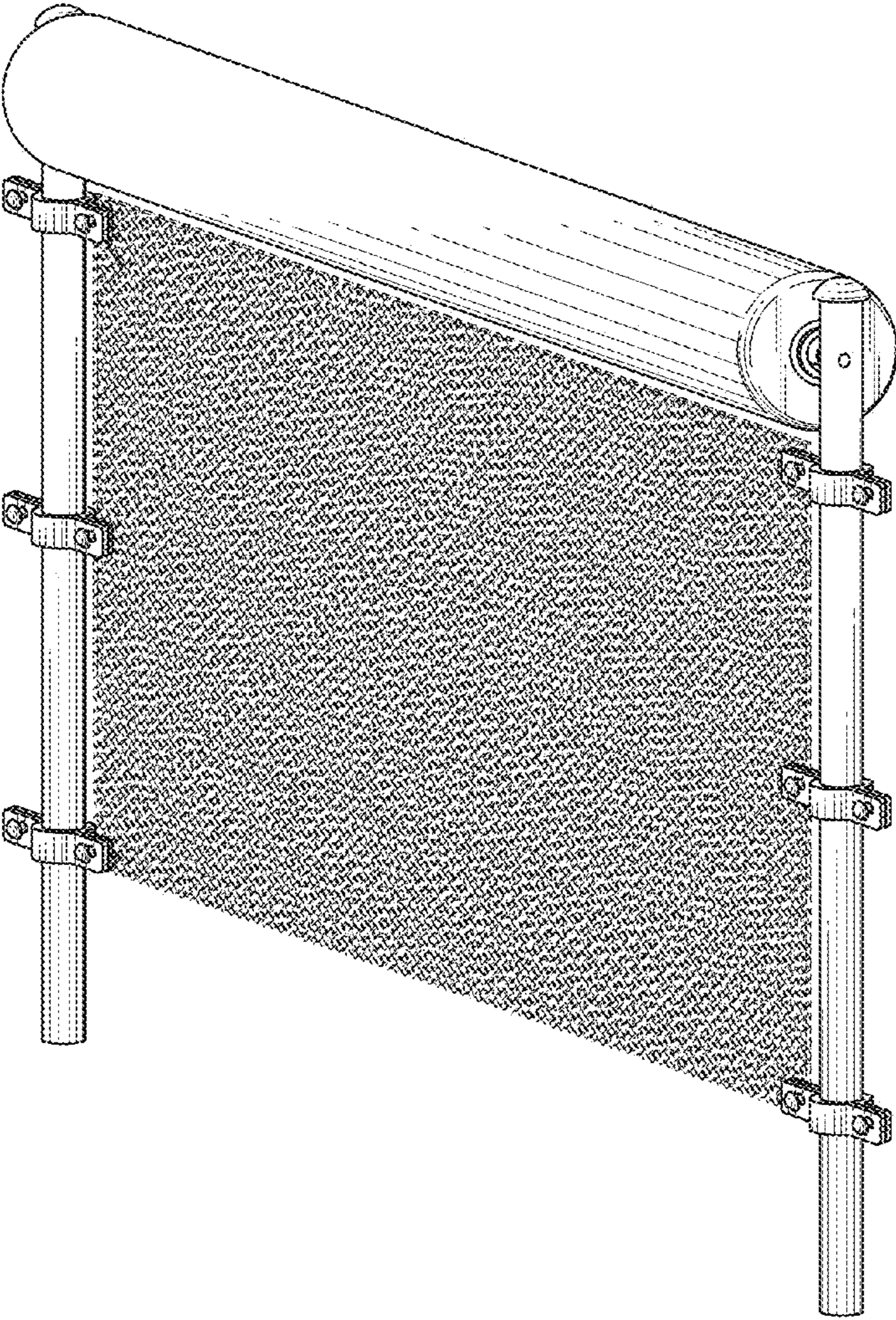

FIG. 7