



US00D751640S

(12) **United States Design Patent**
Nicklaus et al.

(10) **Patent No.:** **US D751,640 S**
(45) **Date of Patent:** **** *Mar. 15, 2016**

(54) **INTERACTIVE ELECTRONIC CARD WITH DISPLAY AND BUTTON**

4,720,860 A 1/1988 Weiss
4,786,791 A 11/1988 Hodama
4,791,283 A 12/1988 Burkhardt
4,797,542 A 1/1989 Hara
5,038,251 A 8/1991 Sugiyama et al.
5,168,520 A 12/1992 Weiss
5,237,614 A 8/1993 Weiss

(71) Applicant: **Dynamics Inc.**, Cheswick, PA (US)

(72) Inventors: **Eric R. Nicklaus**, Pittsburgh, PA (US);
Jeffrey D. Mullen, Pittsburgh, PA (US)

(Continued)

(73) Assignee: **DYNAMICS INC.**, Pittsburgh, PA (US)

FOREIGN PATENT DOCUMENTS

(*) Notice: This patent is subject to a terminal disclaimer.

JP 05210770 A 8/1993
WO WO9852735 11/1998

(Continued)

(**) Term: **14 Years**

OTHER PUBLICATIONS

(21) Appl. No.: **29/447,412**

U.S. Appl. No. 60/594,300, Poidomani et al.

(22) Filed: **Mar. 4, 2013**

(Continued)

(51) **LOC (10) Cl.** **19-08**

(52) **U.S. Cl.**
USPC **D19/10**

Primary Examiner — Caron D Veynar
Assistant Examiner — Abraham Bahta

(58) **Field of Classification Search**
USPC D19/1-12, 20-34; 40/124.01-124.15,
40/672, 661, 726, 776; 283/72, 74, 75,
283/103, 105, 106; 206/449; D21/385;
D20/10, 22, 27, 40, 42, 11;
D14/435-437

(57) **CLAIM**

The ornamental design for an interactive electronic card with display and button, as shown and described.

CPC .. B42D 15/022; B42D 15/042; B42D 15/045;
B42D 15/027; B42D 25/29; B42D 25/00;
B42D 15/00; B42D 25/20; B42D 25/30;
B42D 25/40; B42D 25/23; B42D 25/26;
B42D 25/285

DESCRIPTION

FIG. 1 is a front, bottom, and left side perspective view of our new design for an interactive electronic card with display and button;
FIG. 2 is a back, top, and left side perspective view thereof;
FIG. 3 is a front side view thereof;
FIG. 4 is a back side view thereof;
FIG. 5 is a top side view thereof;
FIG. 6 is a bottom side view thereof;
FIG. 7 is a left side view thereof; and,
FIG. 8 is a right side view thereof.

See application file for complete search history.

The broken lines showing environment in the drawings are for illustrative purposes only and form no part of the claimed design.

(56) **References Cited**

U.S. PATENT DOCUMENTS

4,353,064 A 10/1982 Stamm
4,394,654 A 7/1983 Hofmann-Cerfontaine
4,614,861 A 9/1986 Pavlov et al.
4,667,087 A 5/1987 Quintana
4,701,601 A 10/1987 Francini et al.

1 Claim, 5 Drawing Sheets

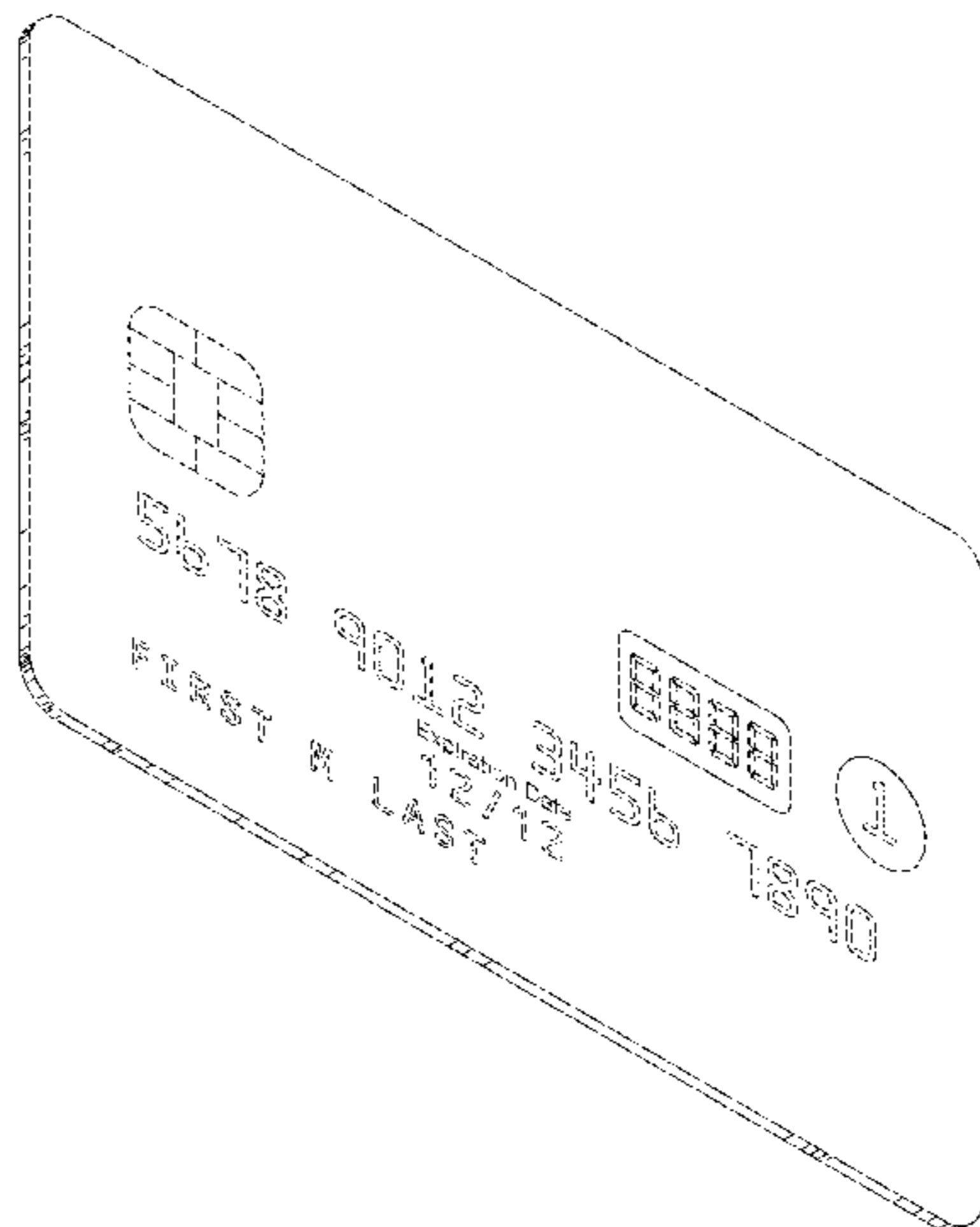

(56)

References Cited

U.S. PATENT DOCUMENTS

5,276,311 A	1/1994	Hennige	7,083,094 B2	8/2006	Cooper
5,347,580 A	9/1994	Molva et al.	7,100,049 B2	8/2006	Gasparini et al.
5,361,062 A	11/1994	Weiss et al.	7,100,821 B2	9/2006	Rasti
5,412,199 A	5/1995	Finkelstein et al.	7,111,172 B1	9/2006	Duane et al.
5,434,398 A	7/1995	Goldberg	7,114,652 B2	10/2006	Moulllette et al.
5,434,405 A	7/1995	Finkelstein et al.	7,136,514 B1	11/2006	Wong
5,478,994 A	12/1995	Rahman	7,140,550 B2	11/2006	Ramachandran
5,479,512 A	12/1995	Weiss	7,163,153 B2	1/2007	Blossom
5,484,997 A	1/1996	Haynes	7,195,154 B2	3/2007	Routhenstein
5,485,519 A	1/1996	Weiss	7,197,639 B1	3/2007	Juels et al.
5,585,787 A	12/1996	Wallerstein	7,219,368 B2	5/2007	Juels et al.
5,591,949 A	1/1997	Bernstein	7,225,537 B2	6/2007	Reed
5,608,203 A	3/1997	Finkelstein et al.	7,225,994 B2	6/2007	Finkelstein
5,623,552 A	4/1997	Lane	7,246,752 B2	7/2007	Brown
5,657,388 A	8/1997	Weiss	7,298,243 B2	11/2007	Juels et al.
5,834,747 A	11/1998	Cooper	7,334,732 B2	2/2008	Cooper
5,834,756 A	11/1998	Gutman et al.	7,337,326 B2	2/2008	Palmer et al.
5,856,661 A	1/1999	Finkelstein et al.	7,346,775 B2	3/2008	Gasparini et al.
5,864,623 A	1/1999	Messina et al.	7,356,696 B1	4/2008	Jakobsson et al.
5,907,142 A	5/1999	Kelsey	7,357,319 B1	4/2008	Lin et al.
5,913,203 A	6/1999	Wong et al.	7,359,507 B2	4/2008	Kaliski
5,937,394 A	8/1999	Wong et al.	7,360,688 B1	4/2008	Harris
5,955,021 A	9/1999	Tiffany, III	7,363,494 B2	4/2008	Brainard et al.
5,956,699 A	9/1999	Wong et al.	7,380,710 B2	6/2008	Brown
6,025,054 A	2/2000	Tiffany, III	7,398,253 B1	7/2008	Pinnell
6,045,043 A	4/2000	Bashan et al.	7,404,087 B2	7/2008	Teunen
6,076,163 A	6/2000	Hoffstein et al.	7,424,570 B2	9/2008	D'Albore et al.
6,085,320 A	7/2000	Kaliski	7,427,033 B1	9/2008	Roskind
6,095,416 A	8/2000	Grant et al.	7,454,349 B2	11/2008	Teunen et al.
6,130,621 A	10/2000	Weiss	7,461,250 B1	12/2008	Duane et al.
6,145,079 A	11/2000	Mitty et al.	7,461,399 B2	12/2008	Juels et al.
6,157,920 A	12/2000	Jakobsson et al.	7,472,093 B2	12/2008	Juels
6,161,181 A	12/2000	Haynes, III et al.	7,472,829 B2	1/2009	Brown
6,176,430 B1	1/2001	Finkelstein et al.	7,494,055 B2	2/2009	Fernandes et al.
6,182,894 B1	2/2001	Hackett et al.	7,502,467 B2	3/2009	Brainard et al.
6,189,098 B1	2/2001	Kaliski	7,502,933 B2	3/2009	Jakobsson et al.
6,199,052 B1	3/2001	Mitty et al.	7,503,485 B1	3/2009	Routhenstein
6,206,293 B1	3/2001	Gutman et al.	7,516,492 B1	4/2009	Nisbet et al.
6,240,184 B1	5/2001	Huynh et al.	7,523,301 B2	4/2009	Nisbet et al.
6,241,153 B1	6/2001	Tiffany, III	7,530,495 B2	5/2009	Cooper
6,256,873 B1	7/2001	Tiffany, III	7,532,104 B2	5/2009	Juels
6,269,163 B1	7/2001	Rivest et al.	7,543,739 B2	6/2009	Brown et al.
6,286,022 B1	9/2001	Kaliski et al.	7,559,464 B2	7/2009	Routhenstein
6,308,890 B1	10/2001	Cooper	7,562,221 B2	7/2009	Nystrom et al.
6,313,724 B1	11/2001	Osterweil	7,562,222 B2	7/2009	Gasparini et al.
6,389,442 B1	5/2002	Yin et al.	7,580,898 B2	8/2009	Brown et al.
6,393,447 B1	5/2002	Jakobsson et al.	7,584,153 B2	9/2009	Brown et al.
6,411,715 B1	6/2002	Liskov et al.	7,591,426 B2	9/2009	Osterweil et al.
6,446,052 B1	9/2002	Juels	7,591,427 B2	9/2009	Osterweil
6,460,141 B1	10/2002	Olden	7,602,904 B2	10/2009	Juels et al.
6,592,044 B1	7/2003	Wong et al.	7,631,804 B2	12/2009	Brown
6,607,127 B2	8/2003	Wong	7,639,537 B2	12/2009	Sepe et al.
6,609,654 B1	8/2003	Anderson et al.	7,641,124 B2	1/2010	Brown et al.
6,631,849 B2	10/2003	Blossom	7,660,902 B2	2/2010	Graham et al.
6,655,585 B2	12/2003	Shinn	7,828,207 B2	11/2010	Cooper
6,681,988 B2	1/2004	Stack et al.	D675,256 S *	1/2013	Mullen et al. D19/10
6,705,520 B1	3/2004	Pitroda et al.	D676,487 S *	2/2013	Mullen et al. D19/10
6,755,341 B1	6/2004	Wong et al.	D687,487 S *	8/2013	Mullen et al. D19/10
6,764,005 B2	7/2004	Cooper	D687,488 S *	8/2013	Mullen et al. D19/10
6,769,618 B1	8/2004	Finkelstein	D687,489 S *	8/2013	Mullen et al. D19/10
6,805,288 B2	10/2004	Routhenstein et al.	D687,490 S *	8/2013	Mullen et al. D19/10
6,811,082 B2	11/2004	Wong	D687,887 S *	8/2013	Mullen et al. D19/10
6,813,354 B1	11/2004	Jakobsson et al.	D688,744 S *	8/2013	Mullen et al. D19/10
6,817,532 B2	11/2004	Finkelstein	D692,053 S *	10/2013	Mullen et al. D19/10
6,873,974 B1	3/2005	Schutzer	D694,322 S *	11/2013	Mullen et al. D19/10
6,902,116 B2	6/2005	Finkelstein	2001/0034702 A1	10/2001	Mockett et al.
6,970,070 B2	11/2005	Juels et al.	2001/0047335 A1	11/2001	Arndt et al.
6,980,969 B1	12/2005	Tuchler et al.	2002/0059114 A1	5/2002	Cockrill et al.
6,985,583 B1	1/2006	Brainard et al.	2002/0082989 A1	6/2002	Fife et al.
6,991,155 B2	1/2006	Burchette, Jr.	2002/0096570 A1	7/2002	Wong et al.
7,013,030 B2	3/2006	Wong et al.	2002/0120583 A1	8/2002	Keresman, III et al.
7,035,443 B2	4/2006	Wong	2003/0034388 A1	2/2003	Routhenstein et al.
7,039,223 B2	5/2006	Wong	2003/0052168 A1	3/2003	Wong
7,044,394 B2	5/2006	Brown	2003/0057278 A1	3/2003	Wong
7,051,929 B2	5/2006	Li	2003/0116635 A1	6/2003	Taban
			2003/0152253 A1	8/2003	Wong
			2003/0163287 A1	8/2003	Vock et al.
			2003/0173409 A1	9/2003	Vogt et al.
			2003/0179909 A1	9/2003	Wong et al.

(56)

References Cited

U.S. PATENT DOCUMENTS

2003/0179910 A1 9/2003 Wong
 2003/0226899 A1 12/2003 Finkelstein
 2004/0035942 A1 2/2004 Silverman
 2004/0133787 A1 7/2004 Doughty
 2004/0162732 A1 8/2004 Rahim et al.
 2004/0172535 A1 9/2004 Jakobsson
 2004/0177045 A1 9/2004 Brown
 2005/0043997 A1 2/2005 Sohata et al.
 2005/0080747 A1 4/2005 Anderson et al.
 2005/0086160 A1 4/2005 Wong et al.
 2005/0086177 A1 4/2005 Anderson et al.
 2005/0116026 A1 6/2005 Burger et al.
 2005/0119940 A1 6/2005 Concilio et al.
 2005/0154643 A1 7/2005 Doan et al.
 2005/0228959 A1 10/2005 D'Albore et al.
 2006/0000900 A1 1/2006 Fernandes et al.
 2006/0037073 A1 2/2006 Juels et al.
 2006/0041759 A1 2/2006 Kaliski et al.
 2006/0085328 A1 4/2006 Cohen et al.
 2006/0091223 A1 5/2006 Zellner
 2006/0161435 A1 7/2006 Atef et al.
 2006/0163353 A1 7/2006 Moulette et al.
 2006/0174104 A1 8/2006 Crichton et al.
 2006/0196931 A1 9/2006 Holtmanns et al.
 2006/0256961 A1 11/2006 Brainard et al.
 2007/0034700 A1 2/2007 Poidomani et al.
 2007/0114274 A1 5/2007 Gibbs et al.
 2007/0124321 A1 5/2007 Szydlo
 2007/0152070 A1 7/2007 D'Albore
 2007/0152072 A1 7/2007 Frallicciardi et al.
 2007/0153487 A1 7/2007 Frallicciardi et al.
 2007/0174614 A1 7/2007 Duane et al.
 2007/0192249 A1 8/2007 Biffle et al.
 2007/0241183 A1 10/2007 Brown et al.
 2007/0241201 A1 10/2007 Brown et al.
 2007/0256123 A1 11/2007 Duane et al.
 2007/0291753 A1 12/2007 Romano
 2008/0005510 A1 1/2008 Sepe et al.
 2008/0008315 A1 1/2008 Fontana et al.
 2008/0008322 A1 1/2008 Fontana et al.
 2008/0010675 A1 1/2008 Massascusa et al.
 2008/0016351 A1 1/2008 Fontana et al.
 2008/0019507 A1 1/2008 Fontana et al.
 2008/0028447 A1 1/2008 O'Malley et al.

2008/0040271 A1 2/2008 Hammad et al.
 2008/0040276 A1 2/2008 Hammad et al.
 2008/0058016 A1 3/2008 Di Maggio et al.
 2008/0059379 A1 3/2008 Ramaci et al.
 2008/0096326 A1 4/2008 Reed
 2008/0126398 A1 5/2008 Cimino
 2008/0128515 A1 6/2008 Di Iorio
 2008/0148394 A1 6/2008 Poidomani et al.
 2008/0201264 A1 8/2008 Brown et al.
 2008/0209550 A1 8/2008 Di Iorio
 2008/0288699 A1 11/2008 Chichierchia
 2008/0294930 A1 11/2008 Varone et al.
 2008/0302877 A1 12/2008 Musella et al.
 2009/0013122 A1 1/2009 Sepe et al.
 2009/0036147 A1 2/2009 Romano
 2009/0046522 A1 2/2009 Sepe et al.
 2009/0108064 A1 4/2009 Fernandes et al.
 2009/0150295 A1 6/2009 Hatch et al.
 2009/0152365 A1 6/2009 Li et al.
 2009/0242648 A1 10/2009 Di Sirio et al.
 2009/0244858 A1 10/2009 Di Sirio et al.
 2009/0253460 A1 10/2009 Varone et al.
 2009/0255996 A1 10/2009 Brown et al.
 2009/0290704 A1 11/2009 Cimino
 2009/0303885 A1 12/2009 Longo
 2011/0028184 A1 2/2011 Cooper

FOREIGN PATENT DOCUMENTS

WO WO0247019 6/2002
 WO WO2006066322 6/2006
 WO WO2006080929 8/2006
 WO WO2006105092 10/2006
 WO WO2006116772 11/2006
 WO WO2008064403 6/2008

OTHER PUBLICATIONS

U.S. Appl. No. 60/675,388, Poidomani et al.
 The Bank Credit Card Business. Second Edition, American Bankers Association, Washington, D.C., 1996.
 A Day in the Life of a Flux Reversal. <http://www.phrack.org/issues.html?issue=37&id=6#article>. As viewed on Apr. 12, 2010.
 Dynamic Virtual Credit Card Numbers. <http://homes.cerias.purdue.edu/~jtli/paper/fc07.pdf>. As viewed on Apr. 12, 2010.
 English translation of JP 05210770 A.

* cited by examiner

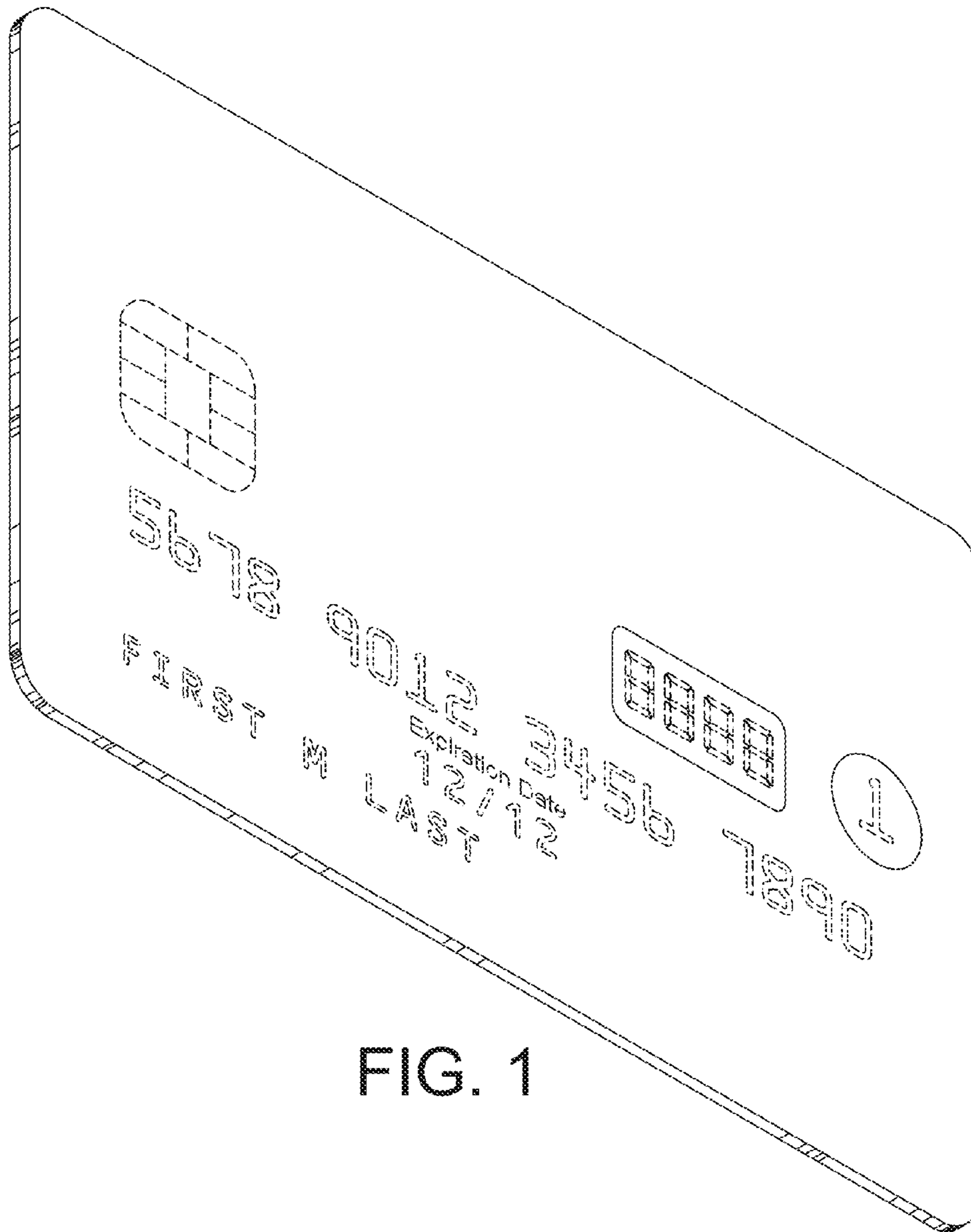

FIG. 1

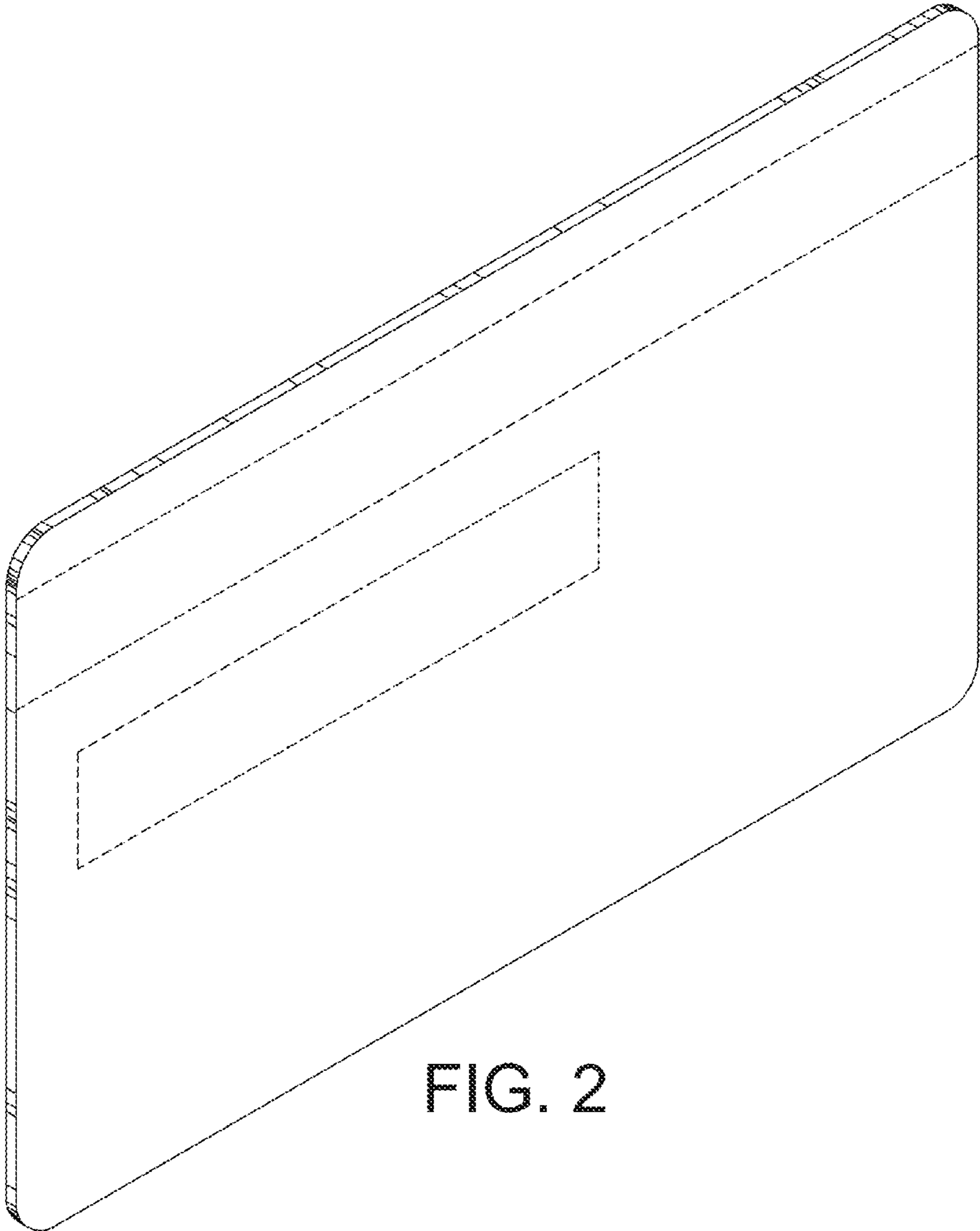

FIG. 2

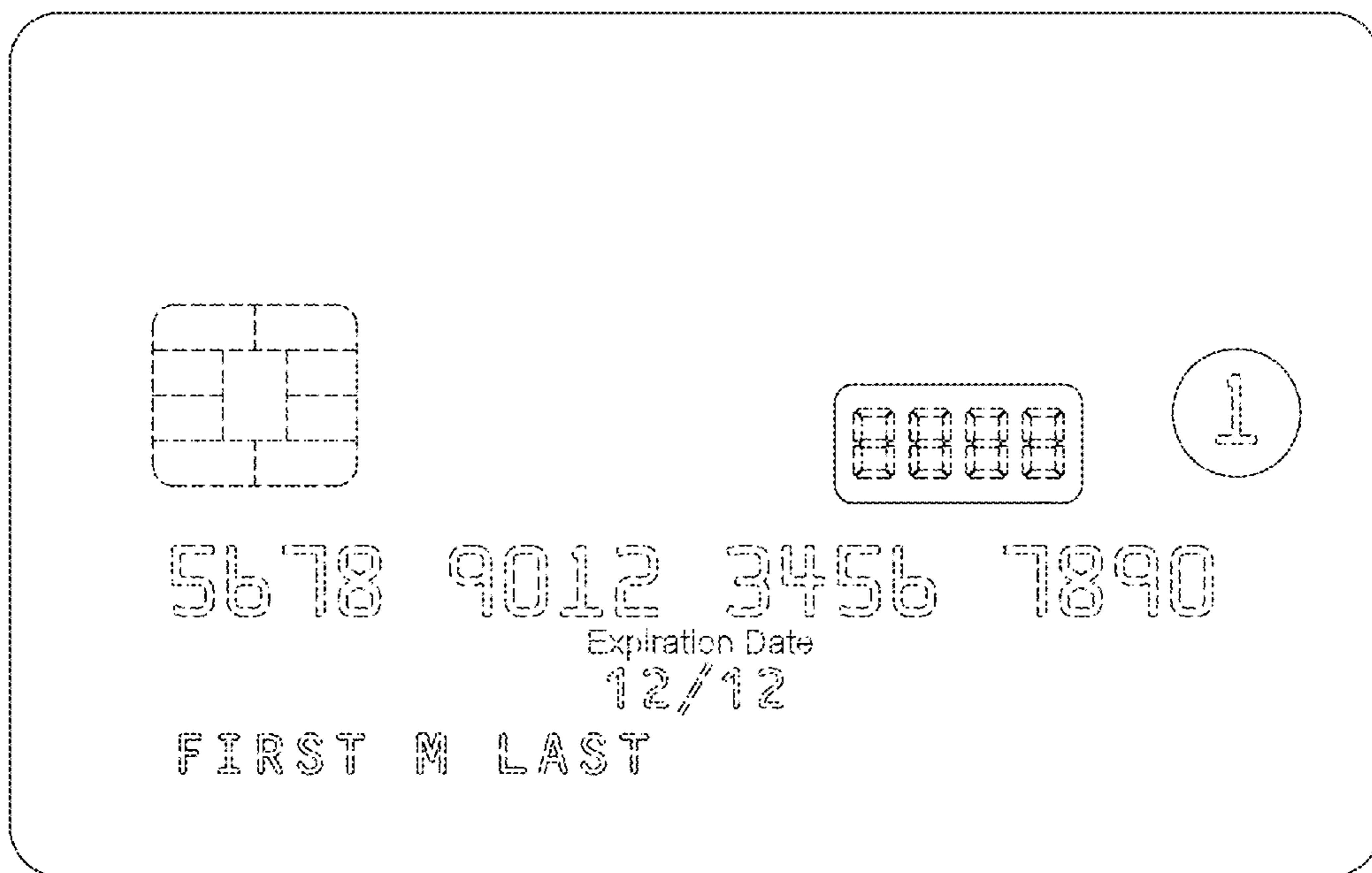

FIG. 3

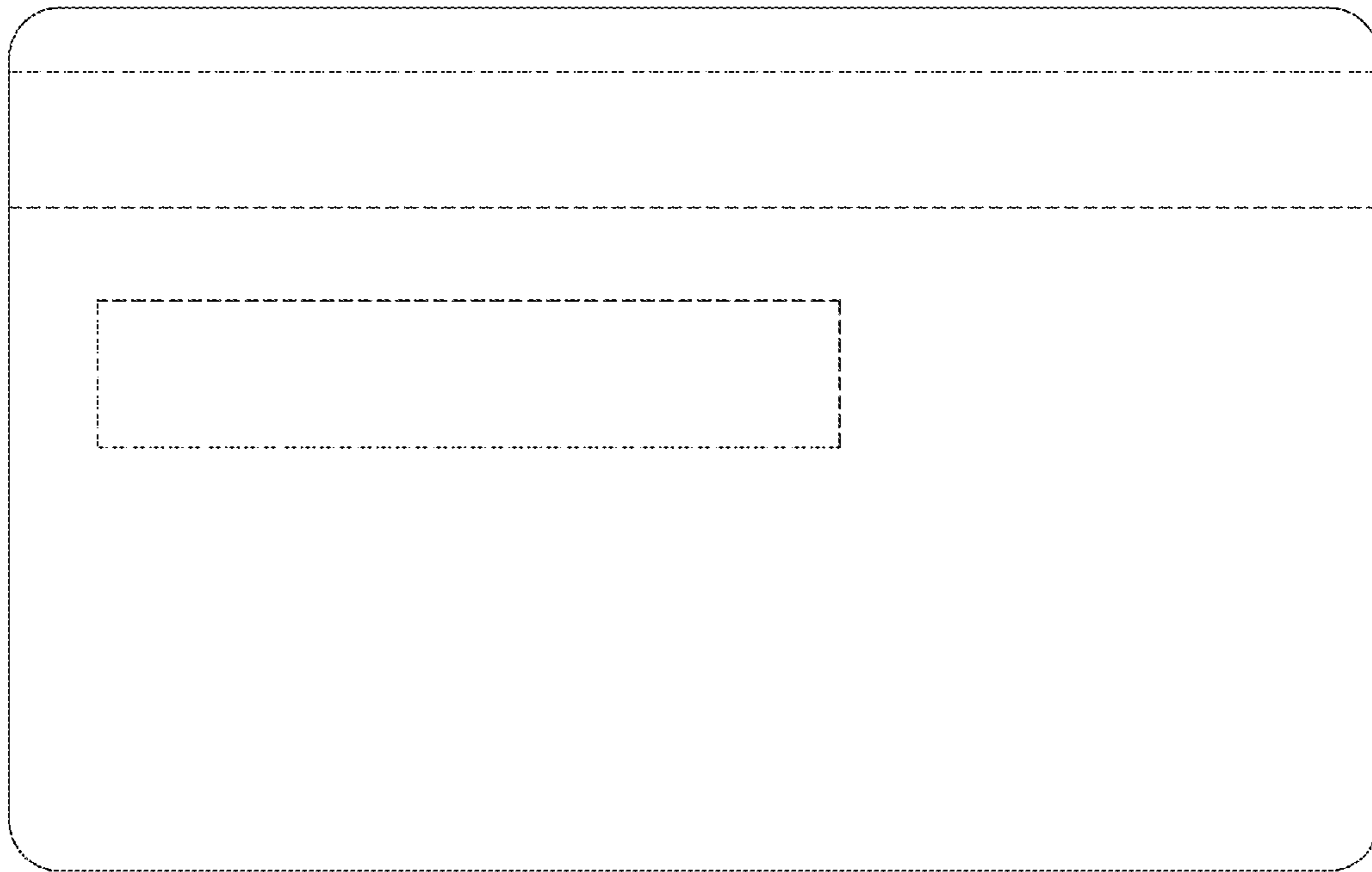

FIG. 4

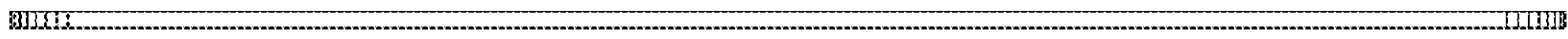

FIG. 5

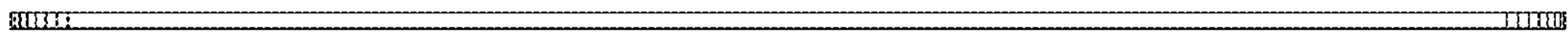

FIG. 6

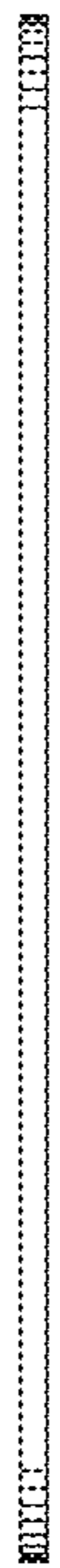

FIG. 7

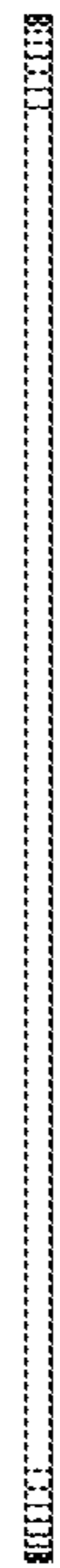

FIG. 8