



US00D751524S

(12) **United States Design Patent**
Nagao

(10) **Patent No.:** **US D751,524 S**
(45) **Date of Patent:** **** Mar. 15, 2016**

- (54) **PORTABLE TERMINAL**
- (71) Applicant: **KYOCERA CORPORATION**,
Kyoto-shi, Kyoto (JP)
- (72) Inventor: **Tomomi Nagao**, Osaka (JP)
- (73) Assignee: **KYOCERA Corporation**, Kyoto (JP)
- (**) Term: **14 Years**
- (21) Appl. No.: **29/494,526**
- (22) Filed: **Jun. 20, 2014**
- (30) **Foreign Application Priority Data**

May 15, 2014 (JP) 2014-010388

- (51) **LOC (10) Cl.** **14-03**
- (52) **U.S. Cl.**
USPC **D14/138 AB**
- (58) **Field of Classification Search**
USPC D14/138 AB, 345, 138 R, 496, 203.4;
455/575.3; D21/517
CPC . G06F 1/1616; H04M 1/0216; H04M 1/0214;
H04M 1/03
See application file for complete search history.

(56) **References Cited**

U.S. PATENT DOCUMENTS

- D408,030 S * 4/1999 Richards D14/138 AB
- D489,699 S * 5/2004 Hwang D14/138 AB
- D536,319 S * 2/2007 Kim D14/138 AB
- D537,430 S * 2/2007 Lee D14/138 AB
- D552,063 S * 10/2007 Jeoung D14/138 AB
- D552,577 S * 10/2007 Kim D14/138 AB
- D553,597 S * 10/2007 Hsu D14/138 AB
- D558,708 S * 1/2008 Wolf D14/138 AB
- D563,932 S * 3/2008 Song D14/138 AB
- 7,387,255 B2 * 6/2008 Kajiwara H04M 1/0216
235/472.02
- D576,995 S * 9/2008 Jinde D14/138 AB

- D578,976 S * 10/2008 Baik D14/138 AB
- D589,481 S * 3/2009 Nara D14/138 AB
- D602,896 S * 10/2009 Finney D14/138 AB
- D603,357 S * 11/2009 Kang D14/138 AB
- D603,826 S * 11/2009 Ham D14/138 AB
- D609,684 S * 2/2010 Nara D14/138 AB
- D614,156 S * 4/2010 Lee D14/138 AB
- D615,065 S * 5/2010 Kim D14/138 AB
- D626,107 S * 10/2010 Nara D14/138 AB
- D627,321 S * 11/2010 Ardinghi D14/138 AB

(Continued)

OTHER PUBLICATIONS

Verizon Now Selling Kyocera's DuraXV Handset, by Eric M Zeman, posted Jan. 22, 2015, [online], [site visited Oct. 31, 2015]. Available from Internet, <URL: <http://www.phonescoop.com/articles/article.php?a=15208>>.*

(Continued)

Primary Examiner — Jeffrey D Asch

(74) *Attorney, Agent, or Firm* — Studebaker & Brackett PC

(57) **CLAIM**

The ornamental design for a portable terminal, as shown and described.

DESCRIPTION

FIG. 1 is a front perspective view of a portable terminal showing my new design;
 FIG. 2 is a front view thereof;
 FIG. 3 is a rear view thereof;
 FIG. 4 is a left side view thereof;
 FIG. 5 is a right side view thereof;
 FIG. 6 is a top plan view thereof;
 FIG. 7 is a bottom view thereof;
 FIG. 8 is a front perspective view thereof in an opened state;
 FIG. 9 is a rear perspective view thereof in the opened state;
 and,
 FIG. 10 is a front view thereof in the opened state.

1 Claim, 8 Drawing Sheets

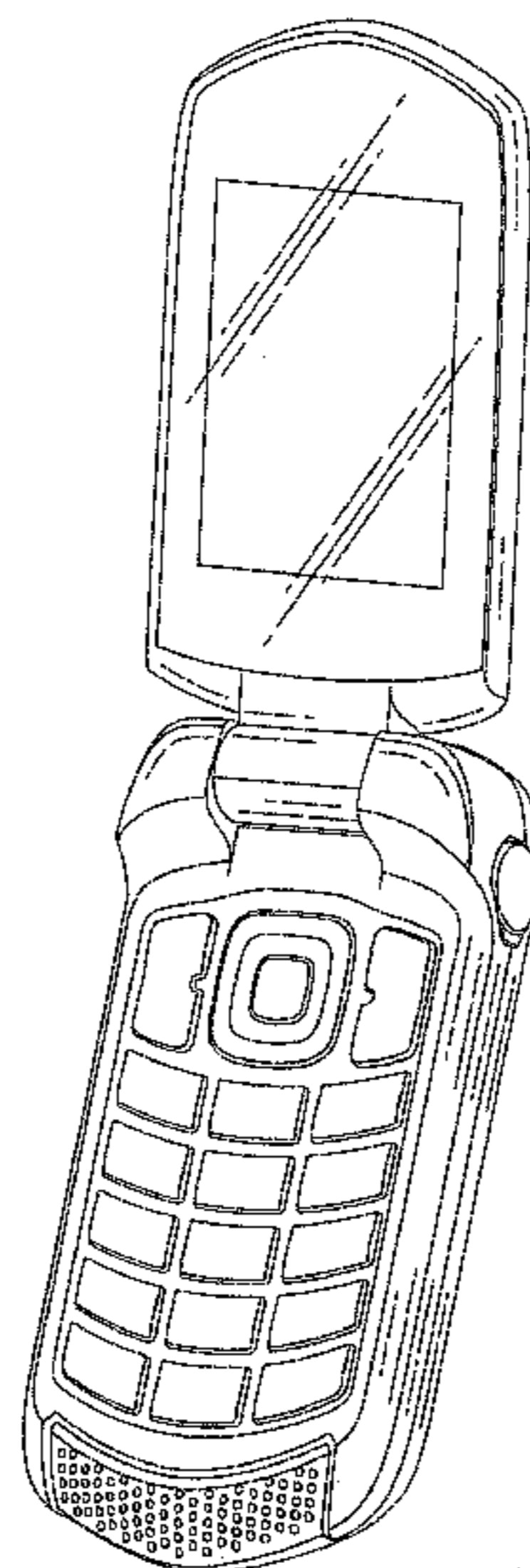
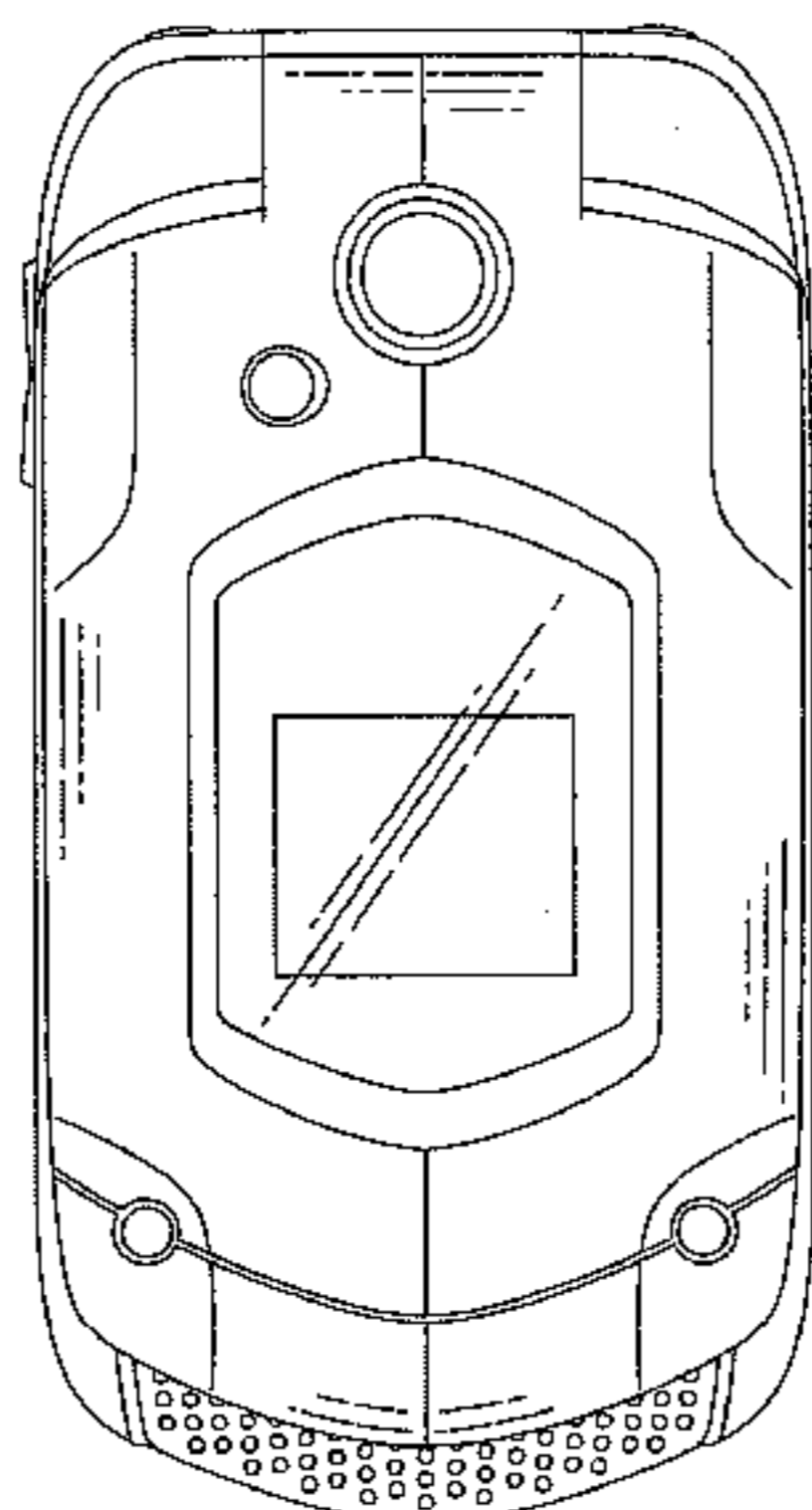

(56)

References Cited

U.S. PATENT DOCUMENTS

D627,322	S	*	11/2010	Ardinghi	D14/138	AB
D648,696	S	*	11/2011	Hirota	D14/138	AB
D649,133	S	*	11/2011	Goto	D14/138	AB
D682,240	S	*	5/2013	Hirota	D14/138	AB
2012/0106106	A1	*	5/2012	Katou	H04M 1/0216	361/752

OTHER PUBLICATIONS

Kyocera DuraMax, announced Oct. 2011, [online], [site visited Sep. 21, 2015]. Available from Internet, <URL: http://www.gsmarena.com/kyocera_duramax-4317.php>.*

Samsung A837 Rugby, announced Sep. 2008, [online], [site visited Sep. 21, 2015]. Available from Internet, <URL: http://www.gsmarena.com/samsung_a837_rugby-2530.php>.*

Casio G'zOne Ravine, announced Oct. 2010, [online], [site visited Sep. 21, 2015]. Available from Internet, <URL: http://www.gsmarena.com/casio_g_zone_ravine-4553.php>.*

Yezz Classic C50, announced Nov. 2014, [online], [site visited Sep. 21, 2015]. Available from Internet, <URL: http://www.gsmarena.com/yezz_classic_c50-pictures-6825.php>.*

Phone Arena website showing Casio G'zOne Ravine Retrieved on Jun. 16, 2014 from URL: http://www.phonearena.com/phones/Verizon-Wireless-Casio-GzOne-Ravine_id4850.

Phone Arena website showing Casio G'zOne Rock C731 Retrieved on Jun. 6, 2014 from URL: http://www.phonearena.com/phones/Verizon-Wireless-Casio-GzOne-Rock-C731_id3839.

Phone Arena website showing Casio G'zOne Boulder Retrieved on Jun. 16, 2014 from URL: http://www.phonearena.com/phones/Verizon-Wireless-Casio-GzOne-Boulder_id2844.

* cited by examiner

FIG. 1

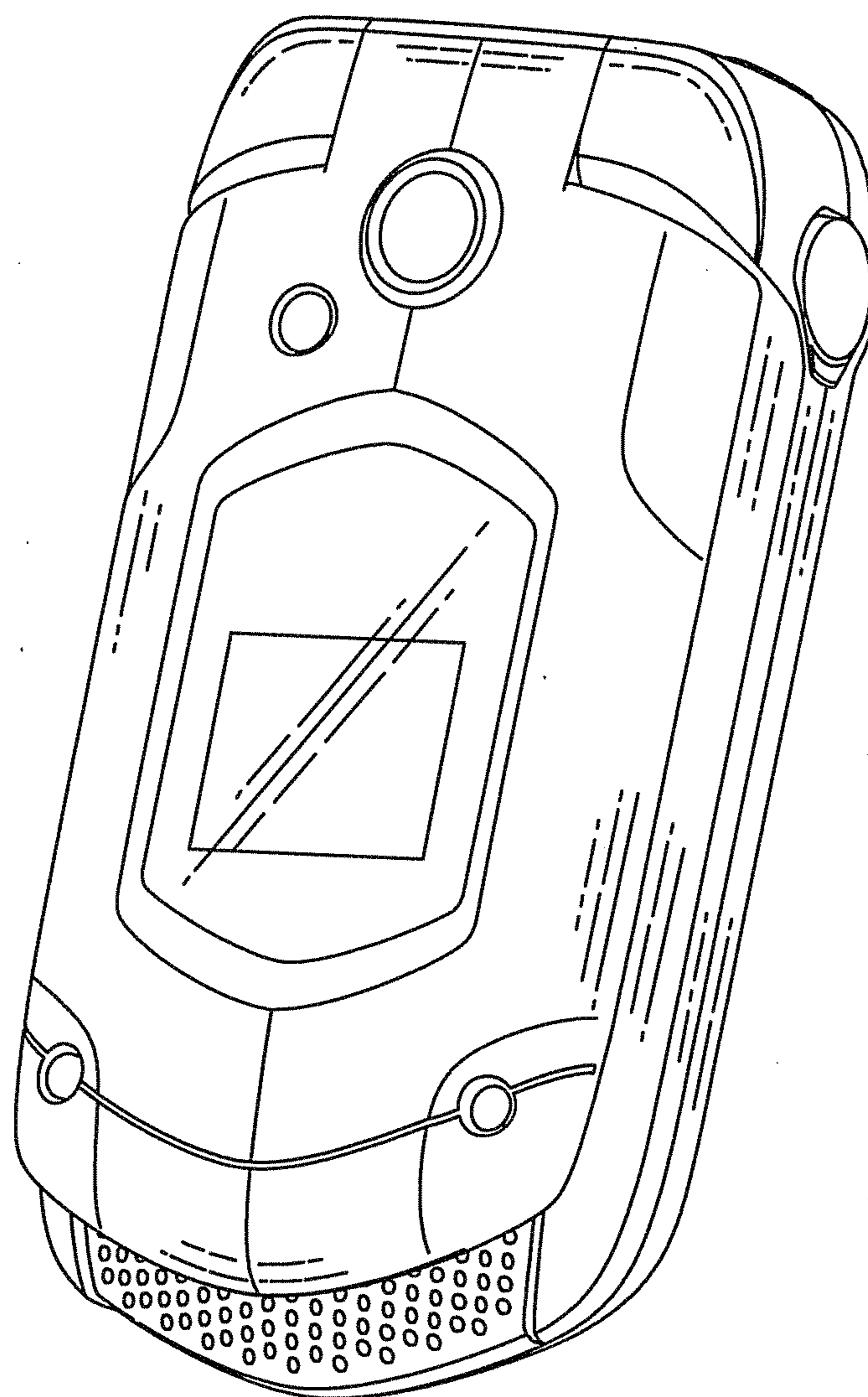

FIG. 2

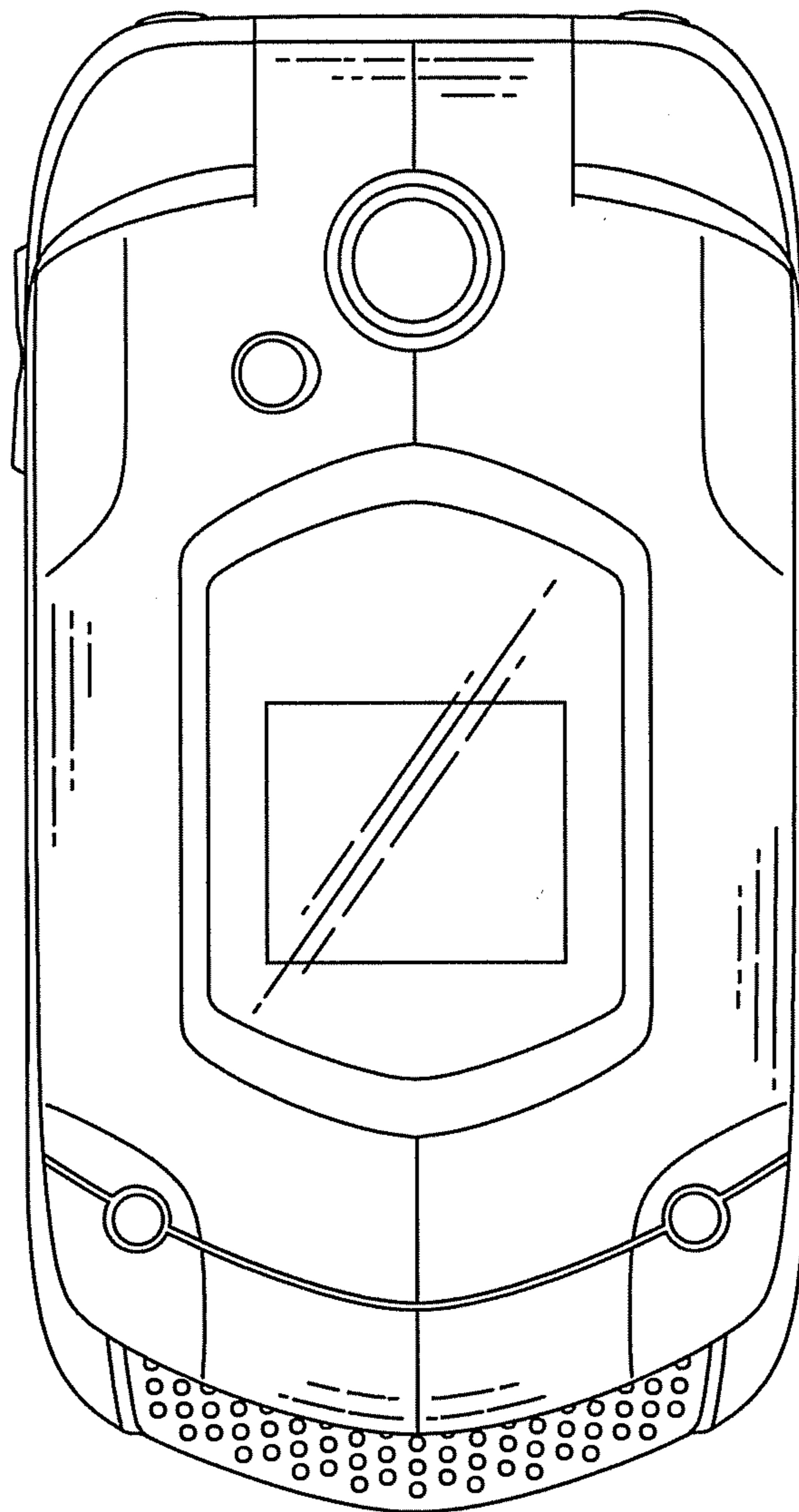

FIG. 3

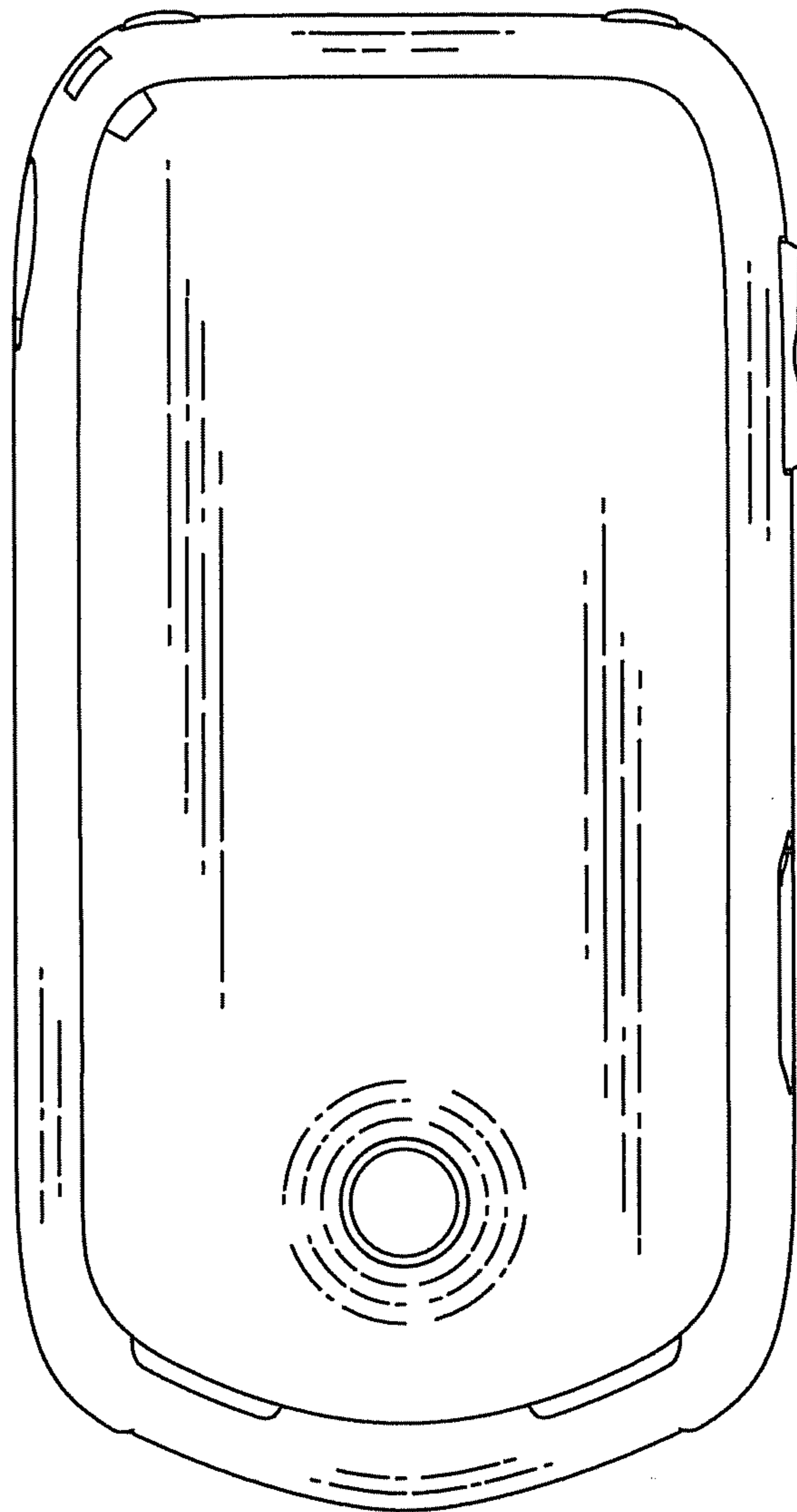

FIG. 4

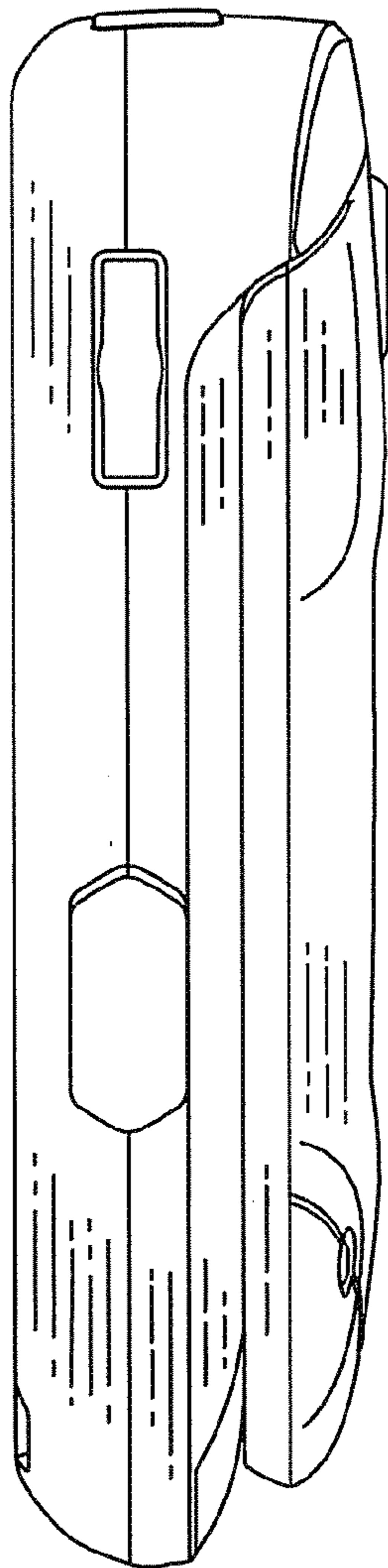

FIG. 5

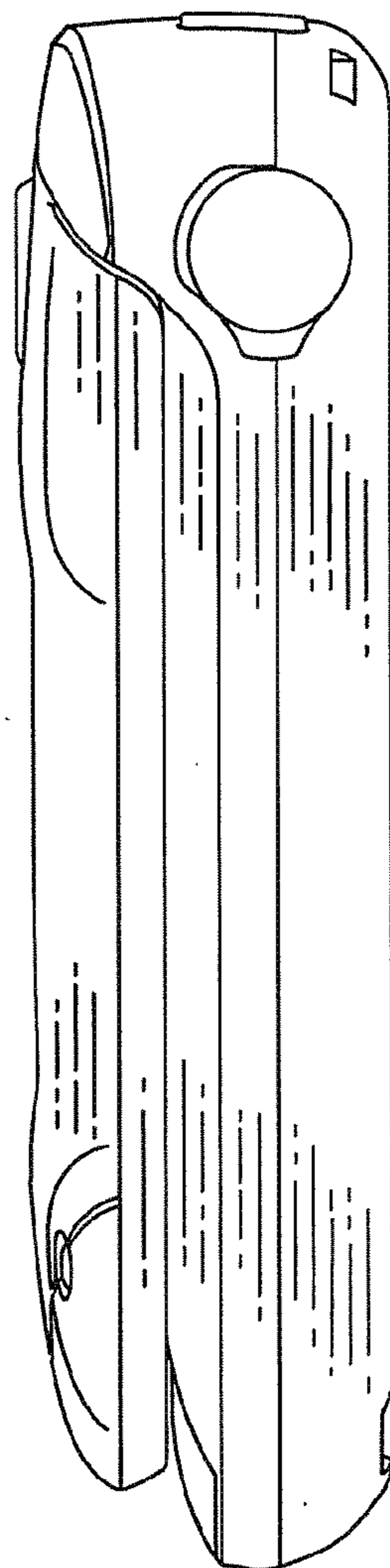

FIG. 6

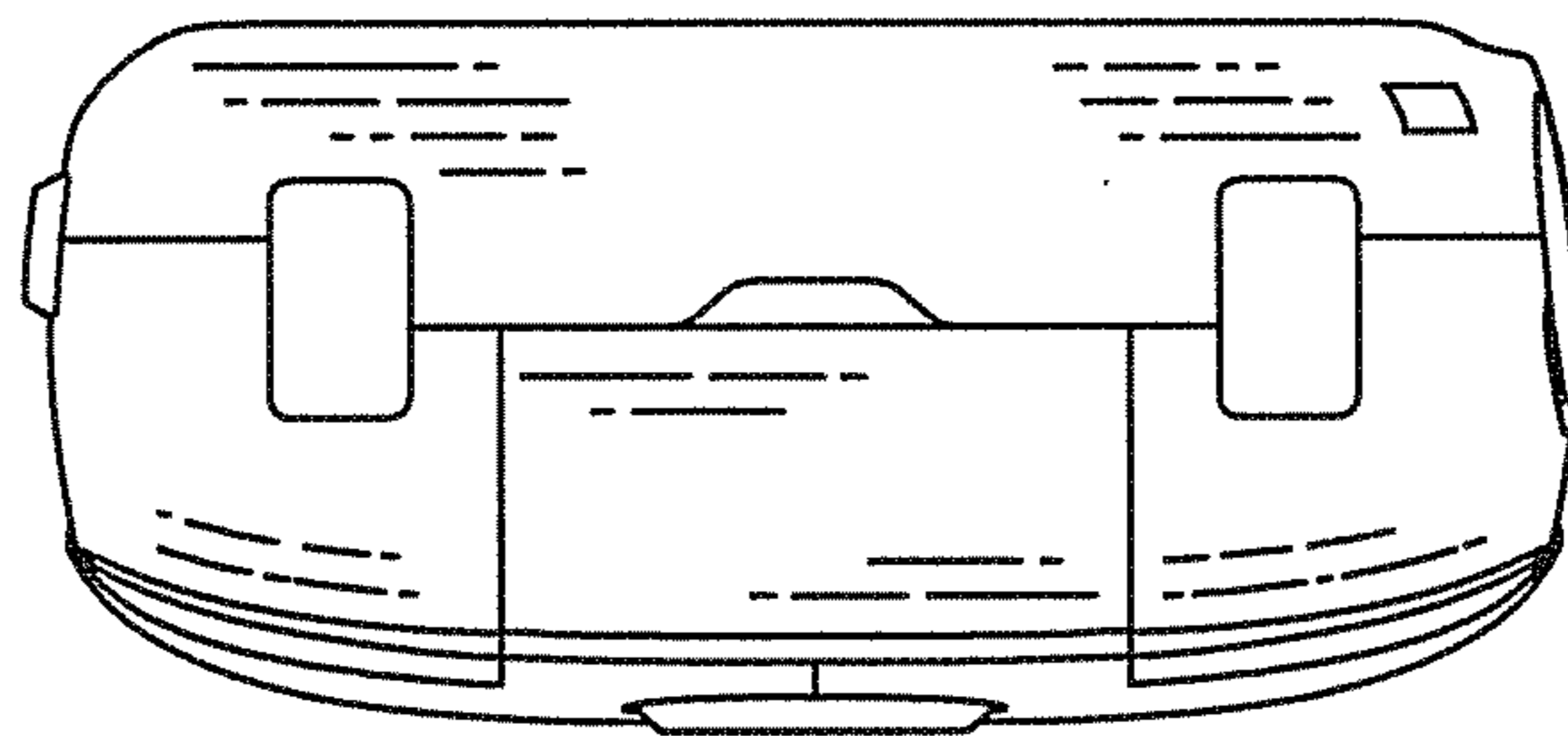

FIG. 7

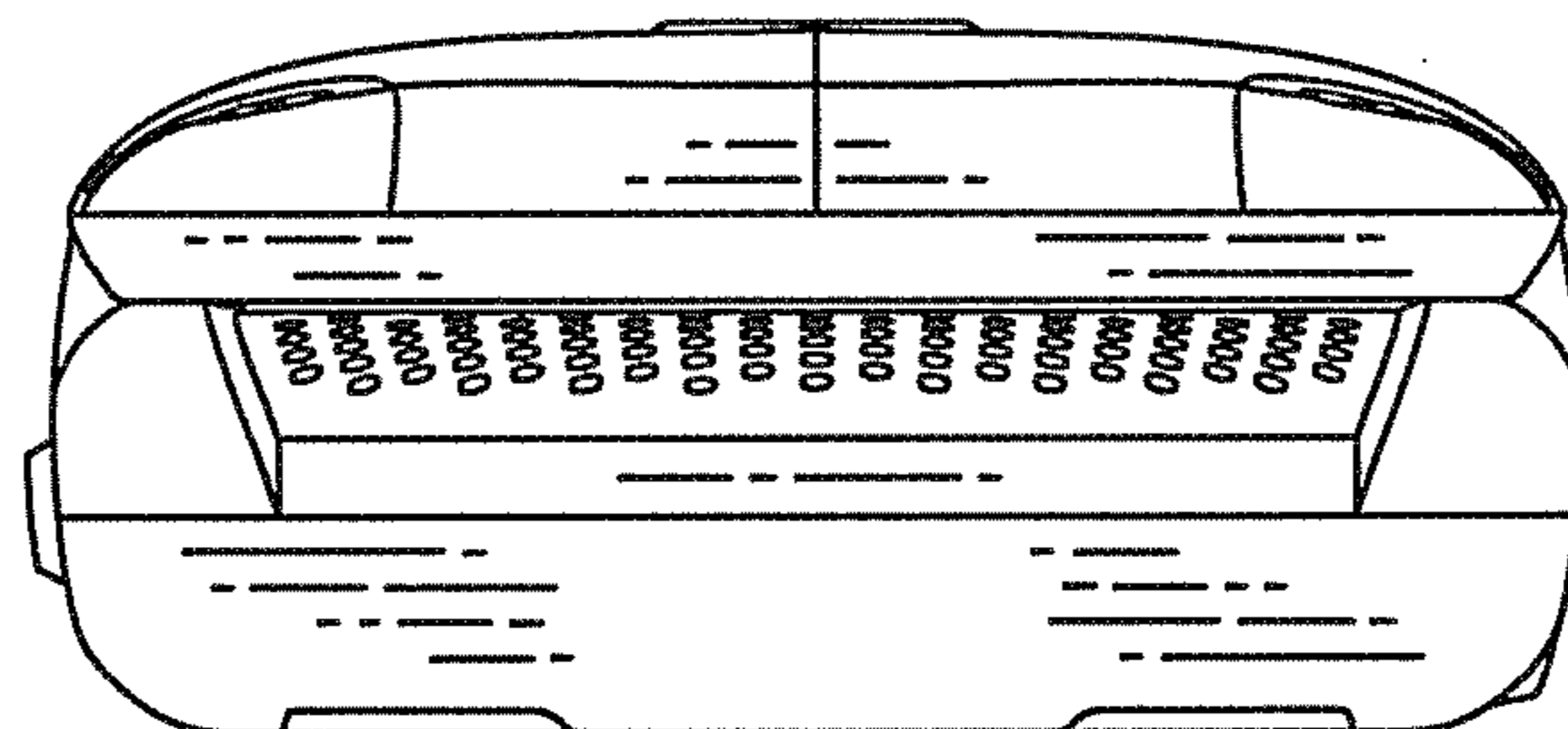

FIG. 8

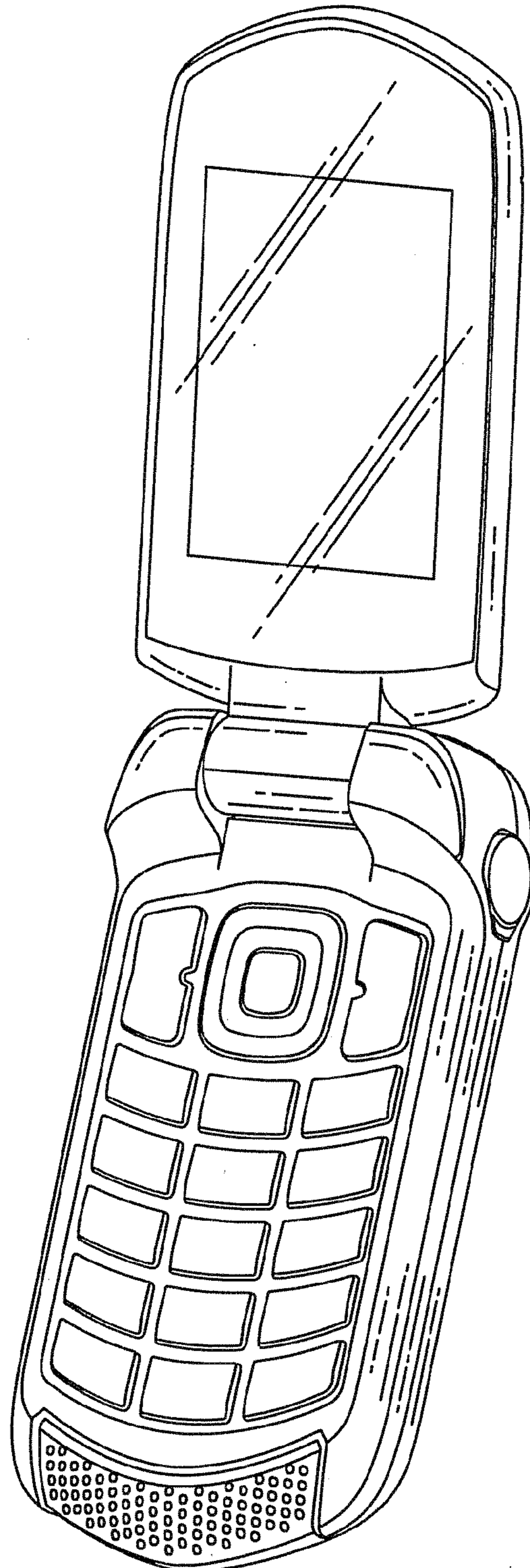

FIG. 9

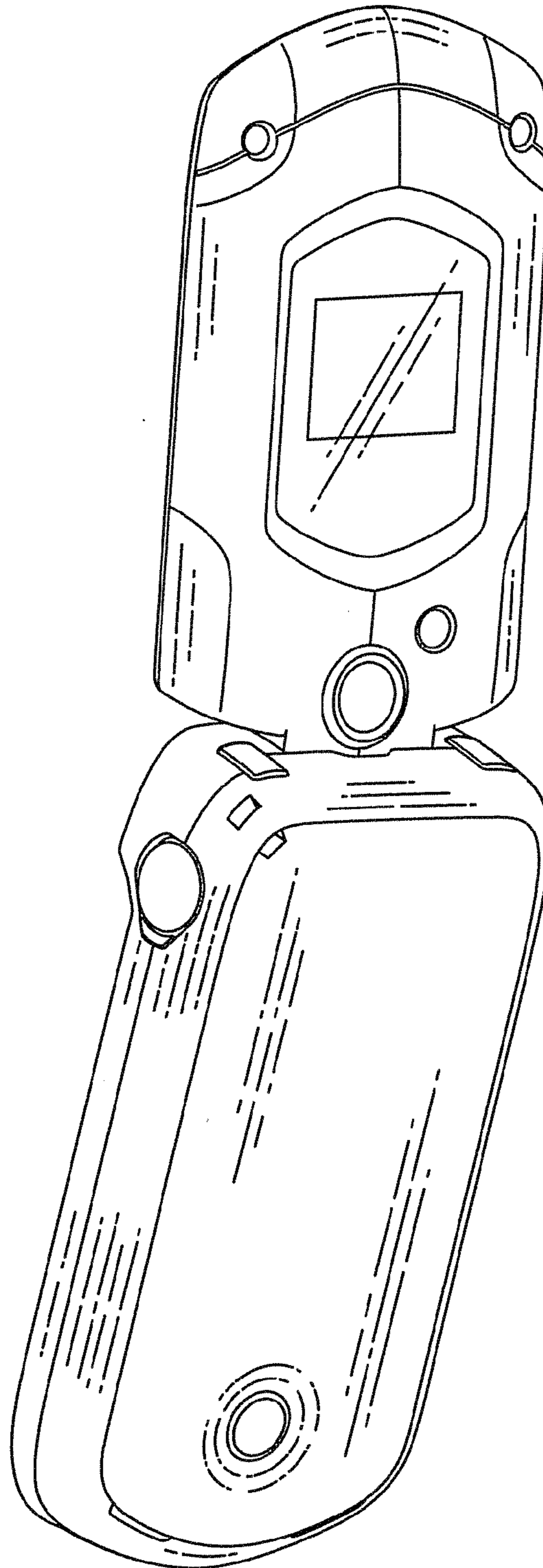

FIG. 10

