



US00D751307S

(12) **United States Design Patent**
Pena

(10) **Patent No.:** **US D751,307 S**
(45) **Date of Patent:** **** Mar. 15, 2016**

(54) **HANGING CHAIR**

(71) Applicant: **Joseph E Pena**, Miami, FL (US)

(72) Inventor: **Joseph E Pena**, Miami, FL (US)

(**) Term: **14 Years**

(21) Appl. No.: **29/501,714**

(22) Filed: **Sep. 8, 2014**

(51) **LOC (10) Cl.** **06-01**

(52) **U.S. Cl.**
USPC **D6/347**

(58) **Field of Classification Search**
USPC D6/334-336, 344, 347, 348, 374, 716,
D6/716.1, 716.2, 716.4

CPC A47D 13/00; A47D 13/08; A47D 13/10;
A47D 13/105; A63G 9/12; A63G 9/16

See application file for complete search history.

(56) **References Cited**

U.S. PATENT DOCUMENTS

- 185,353 A * 12/1876 Rogers A63G 9/16
472/124
- 3,692,305 A * 9/1972 Allen A63G 9/16
472/119
- 5,374,107 A * 12/1994 Schnitzler A47D 13/105
297/273

- D356,692 S * 3/1995 Dawson D6/347
- D364,969 S * 12/1995 Boone D6/347
- 7,175,535 B1 * 2/2007 Marmentini A63G 9/12
297/273
- D616,653 S * 6/2010 Mann D6/344

* cited by examiner

Primary Examiner — Mimoso De

(74) *Attorney, Agent, or Firm* — Christopher J. Vandam,
P.A.; Chris Vandam

(57) **CLAIM**

The ornamental design for a hanging chair, as shown and described.

DESCRIPTION

FIG. 1 shows a perspective view of a hanging chair.
 FIG. 2 shows a perspective view of the hanging chair.
 FIG. 3 shows a back elevation view of the hanging chair.
 FIG. 4 shows a side elevation view of the hanging chair.
 FIG. 5 shows a front elevation view of the hanging chair.
 FIG. 6 shows a top plan view of the hanging chair; and,
 FIG. 7 shows a bottom plan view of the hanging chair.
 A chair suspended from above with shade and harness restraint.
 A sample bracket is shown in broken lines and is not included in the claimed design.

1 Claim, 3 Drawing Sheets

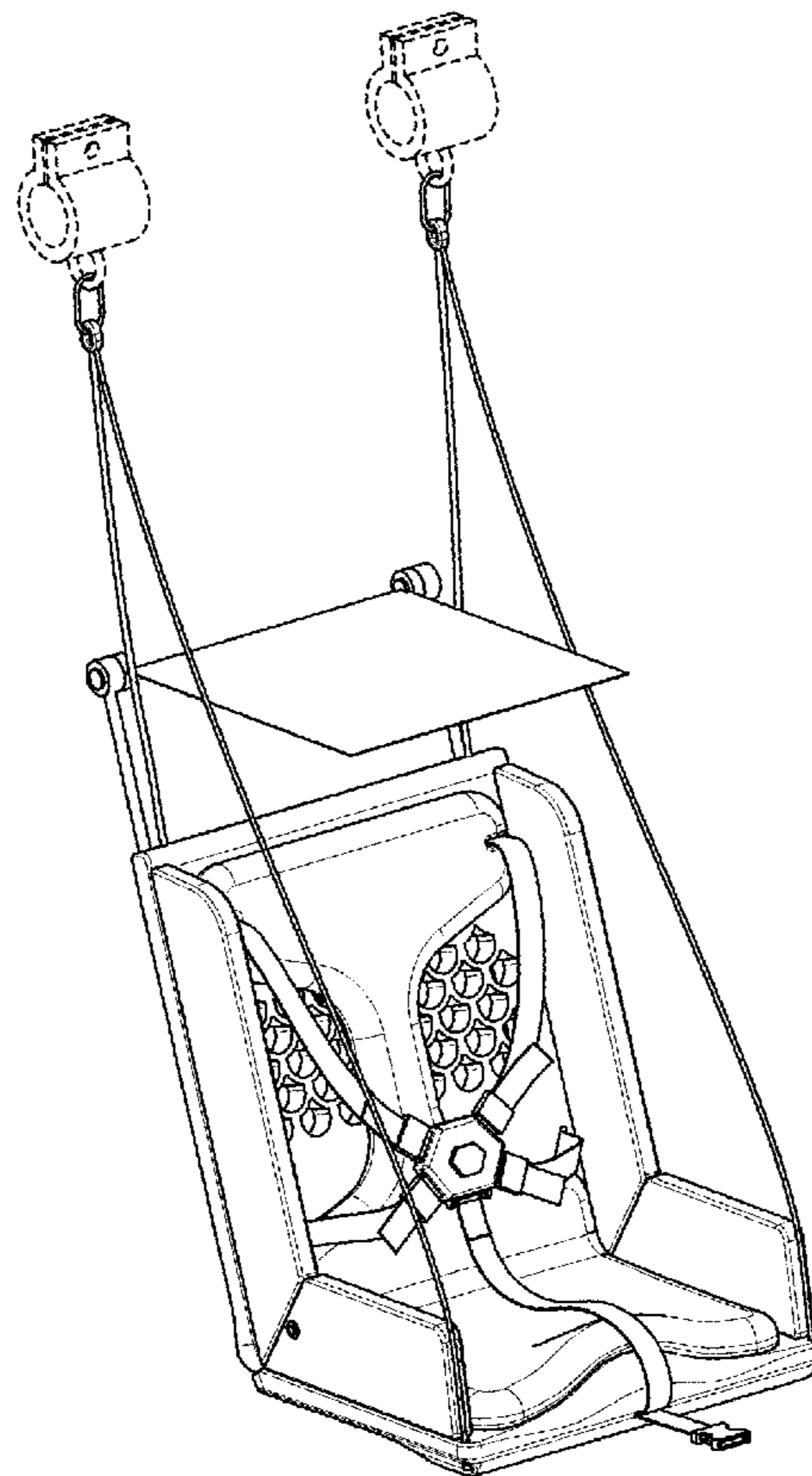

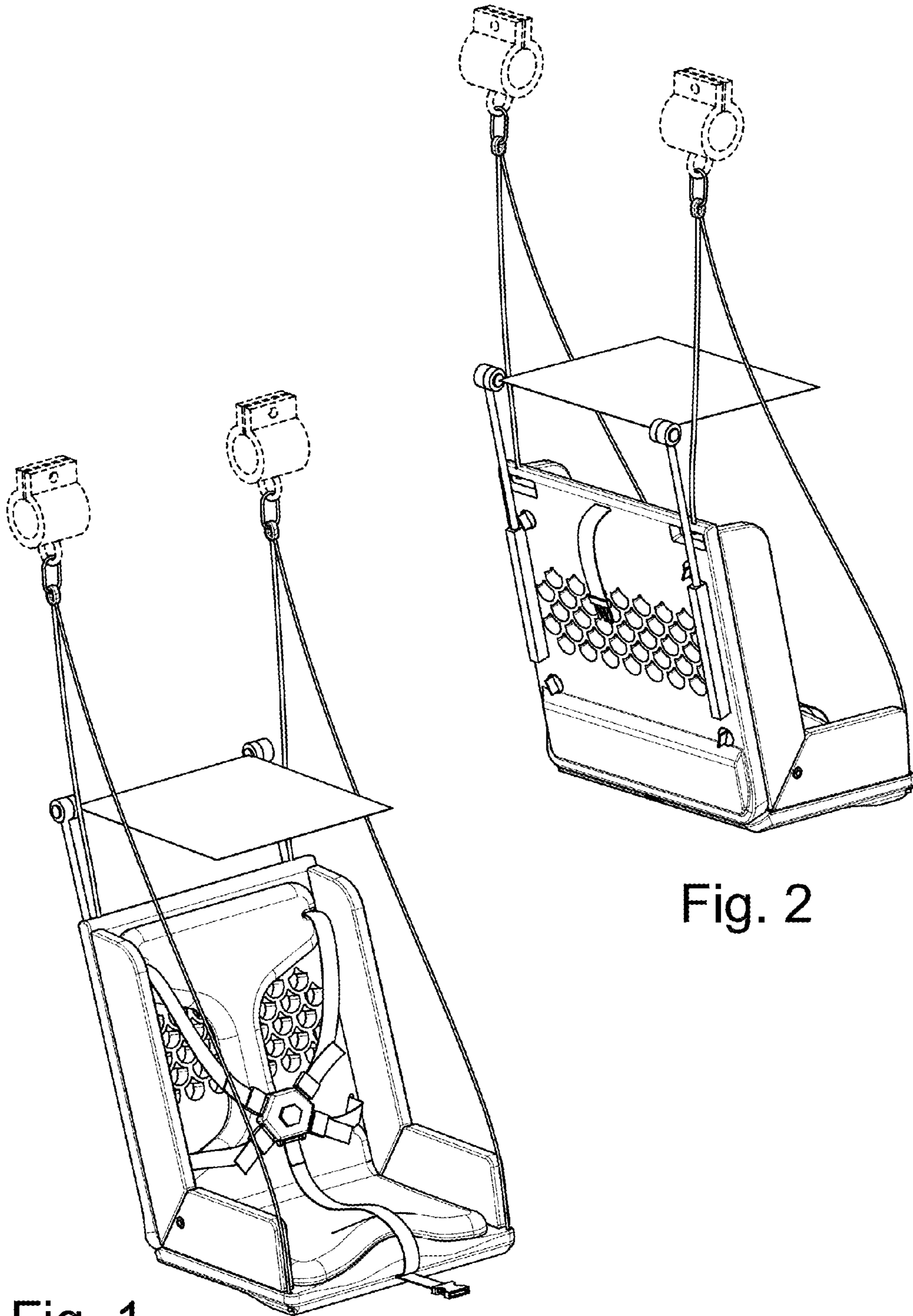

Fig. 1

Fig. 2

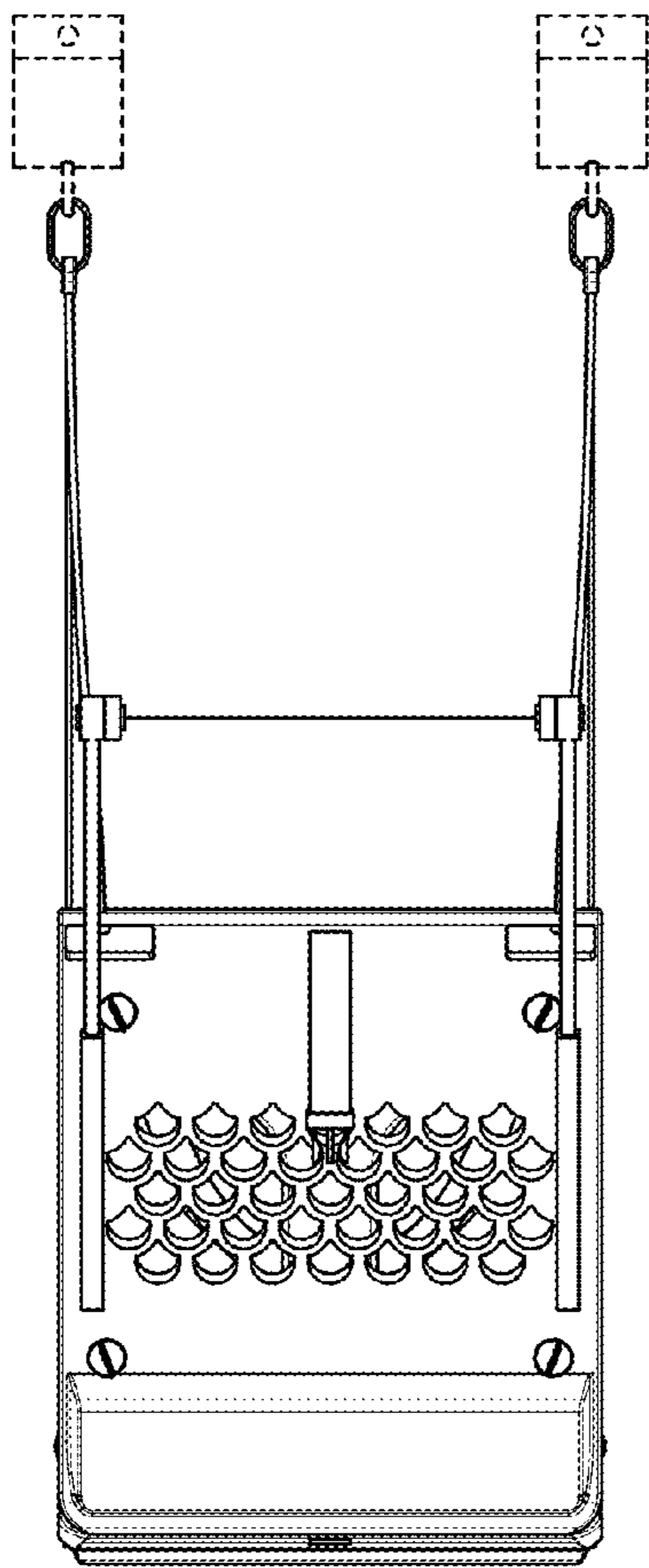

Fig. 3

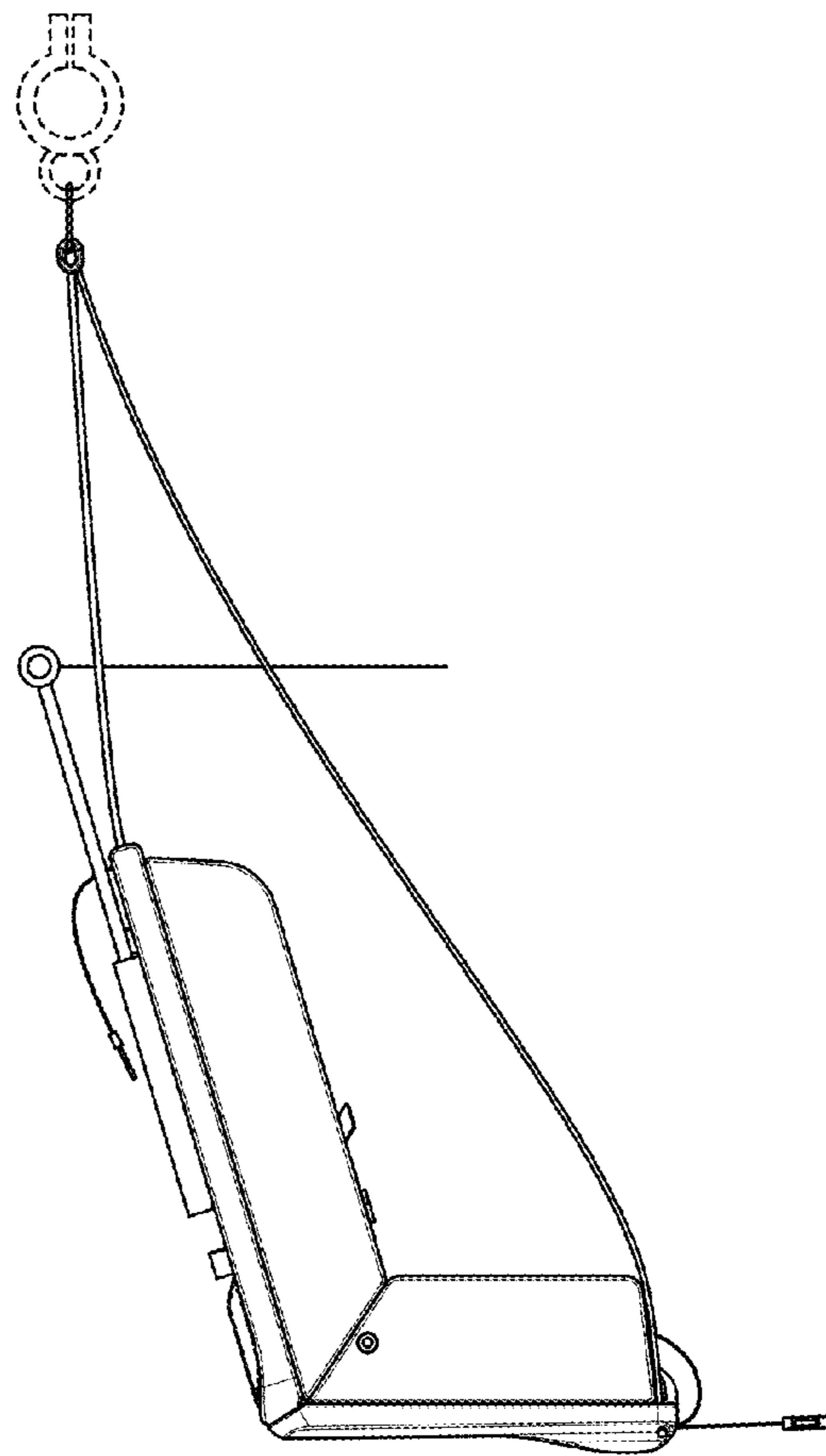

Fig. 4

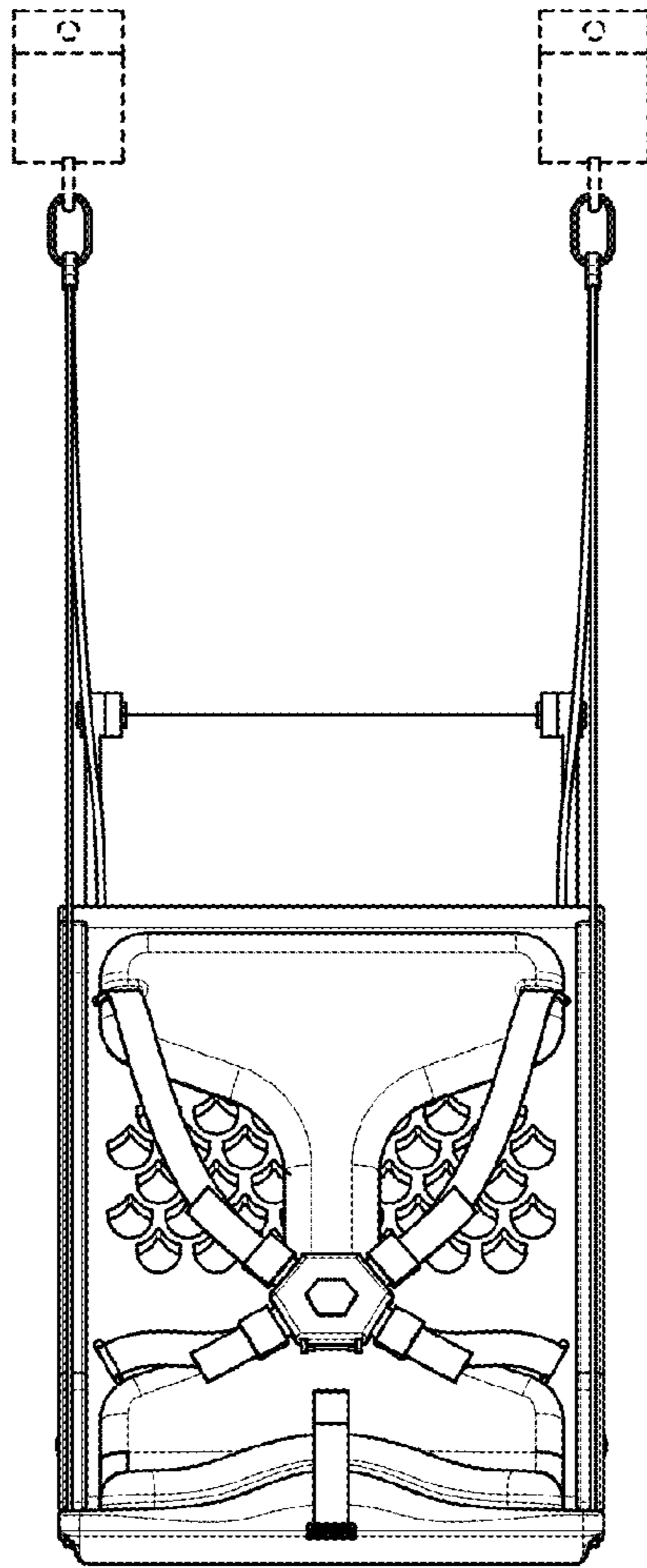

Fig. 5

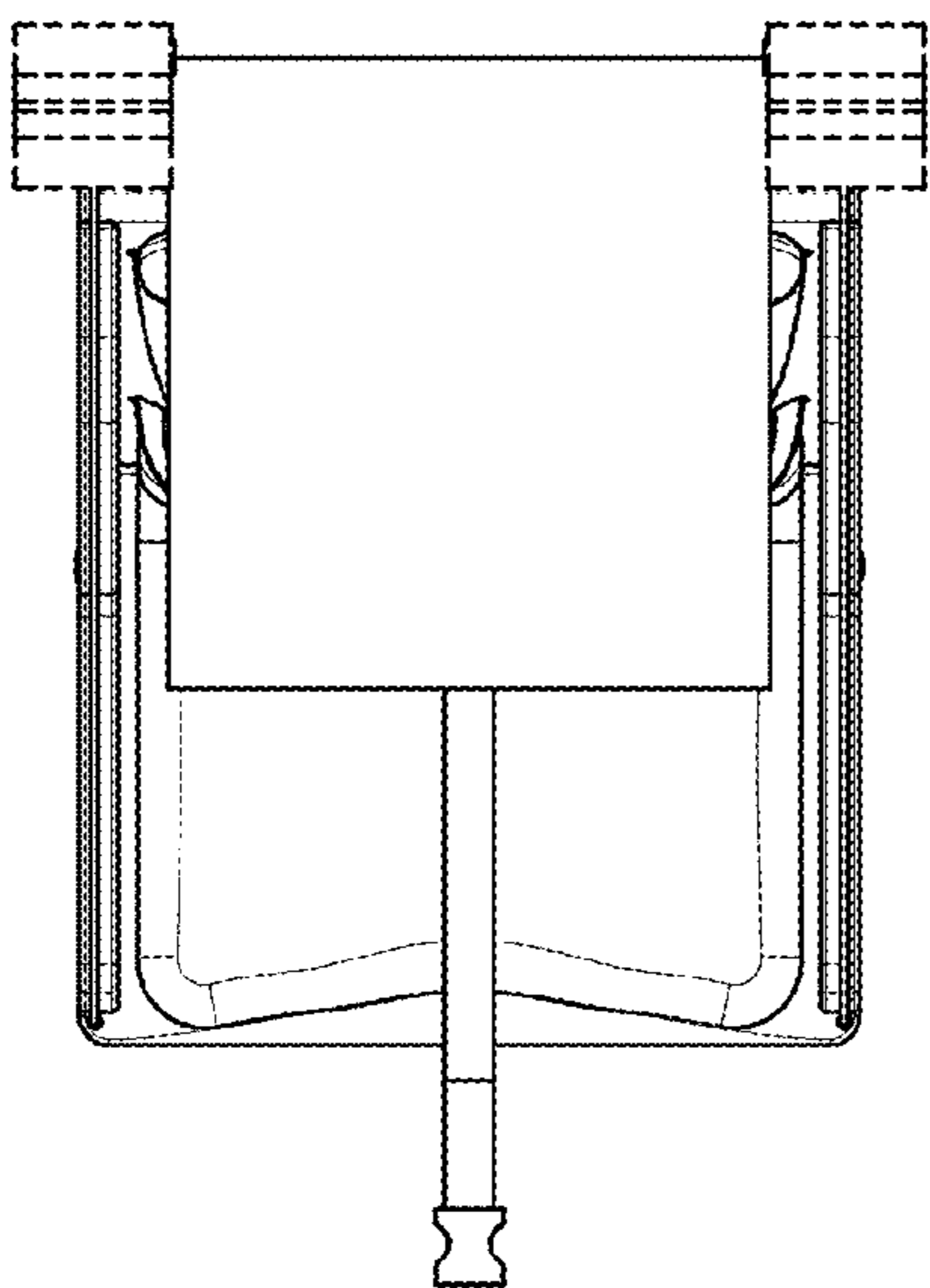

Fig. 6

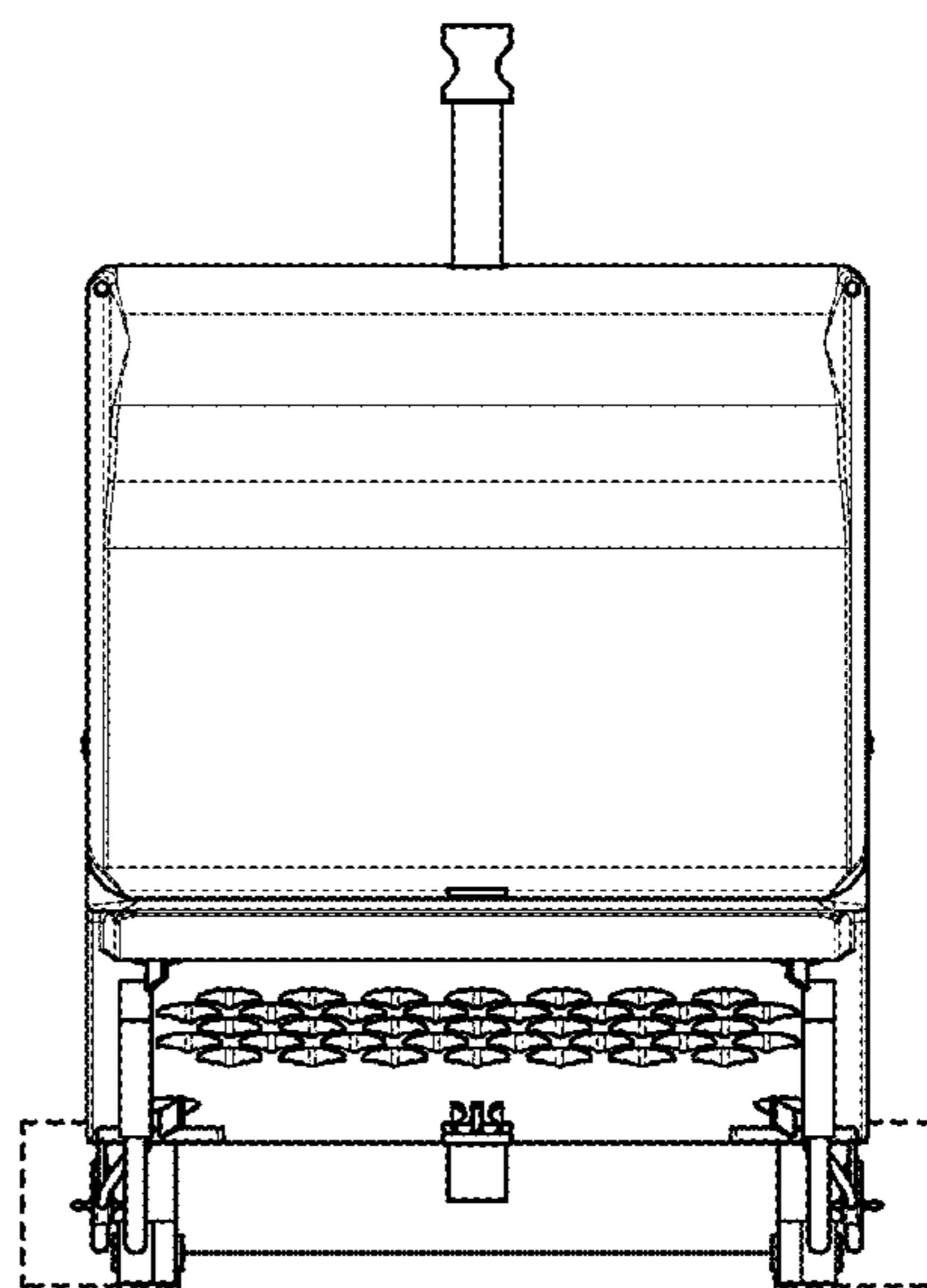

Fig. 7