



US00D751280S

(12) **United States Design Patent**  
**Vasquez**

(10) **Patent No.:** **US D751,280 S**  
(45) **Date of Patent:** **\*\* Mar. 15, 2016**

(54) **COLLAPSIBLE SHOE WITH ACCESSORY ATTACHMENT**

(71) Applicant: **Veronica Vasquez**, Henderson, NV (US)

(72) Inventor: **Veronica Vasquez**, Henderson, NV (US)

(\*\*) Term: **14 Years**

(21) Appl. No.: **29/515,599**

(22) Filed: **Jan. 23, 2015**

(51) **LOC (10) Cl.** ..... **02-04**

(52) **U.S. Cl.**  
USPC ..... **D2/939**; D2/925

(58) **Field of Classification Search**  
USPC ..... D2/896, 919, 923, 925, 939, 946, 976  
CPC ..... A43B 3/10; A43B 3/101; A43B 3/106;  
A43B 3/107; A43B 3/108; A43B 3/24;  
A43B 3/242; A43B 3/244; A43B 3/246;  
A43B 3/248; A43B 5/12; A43B 23/24  
See application file for complete search history.

(56) **References Cited**

**U.S. PATENT DOCUMENTS**

1,525,848	A *	2/1925	Bonaventure	.....	A43B 5/12 36/113
1,912,539	A *	6/1933	Paul	.....	A41B 11/00 36/10
1,937,218	A *	11/1933	Di Rienzo	.....	A43B 5/12 12/142 P
D166,090	S	3/1952	Mailing		
3,426,454	A	2/1969	Mitchell		
3,523,378	A	8/1970	Mitchell		
D247,396	S	3/1978	Schlerth		
D319,140	S *	8/1991	Hernandez	.....	D2/909
D338,093	S	8/1993	Uhr		
D339,669	S *	9/1993	Miller	.....	D2/919
D458,439	S	6/2002	Hudson		
D571,084	S	6/2008	Comeau		
D630,829	S	1/2011	Weisner		
D637,802	S	5/2011	Jankowski		

D651,384	S	1/2012	Wolff		
D652,200	S	1/2012	Wolff		
D668,438	S *	10/2012	Millieret	.....	D2/925
D668,847	S *	10/2012	Gavrieli	.....	D2/925
D668,848	S *	10/2012	Gavrieli	.....	D2/925
D676,634	S *	2/2013	Gavrieli	.....	D2/925
D681,927	S *	5/2013	Gavrieli	.....	D2/925
D681,928	S *	5/2013	Gavrieli	.....	D2/925
D681,929	S *	5/2013	Gavrieli	.....	D2/925
D683,936	S *	6/2013	Gavrieli	.....	D2/925
D688,853	S *	9/2013	Gavrieli	.....	D2/925
D688,854	S *	9/2013	Gavrieli	.....	D2/925
D688,855	S *	9/2013	Gavrieli	.....	D2/925
D689,270	S *	9/2013	Gavrieli	.....	D2/925
D689,272	S *	9/2013	Gavrieli	.....	D2/925
D690,914	S *	10/2013	Gavrieli	.....	D2/925

(Continued)

*Primary Examiner* — Elizabeth J Oswecki

(74) *Attorney, Agent, or Firm* — QuickPatents, LLC; Kevin Prince

(57) **CLAIM**

I claim the ornamental design for a collapsible shoe with accessory attachment, as shown and described.

**DESCRIPTION**

FIG. 1 is a bottom plan view of a collapsible shoe with accessory attachment, showing my new design in an expanded configuration;  
FIG. 2 is a top plan view of FIG. 1;  
FIG. 3 is a left-side elevational view of FIG. 1;  
FIG. 4 is a right-side elevational view of FIG. 1;  
FIG. 5 is a front elevational view of FIG. 1;  
FIG. 6 is a rear elevational view of FIG. 1;  
FIG. 7 is a perspective view of FIG. 1; and,  
FIG. 8 is another perspective view of FIG. 1, shown in a folded configuration.  
The broken lines on the figures represent stitching and are part of the claimed design.

**1 Claim, 6 Drawing Sheets**

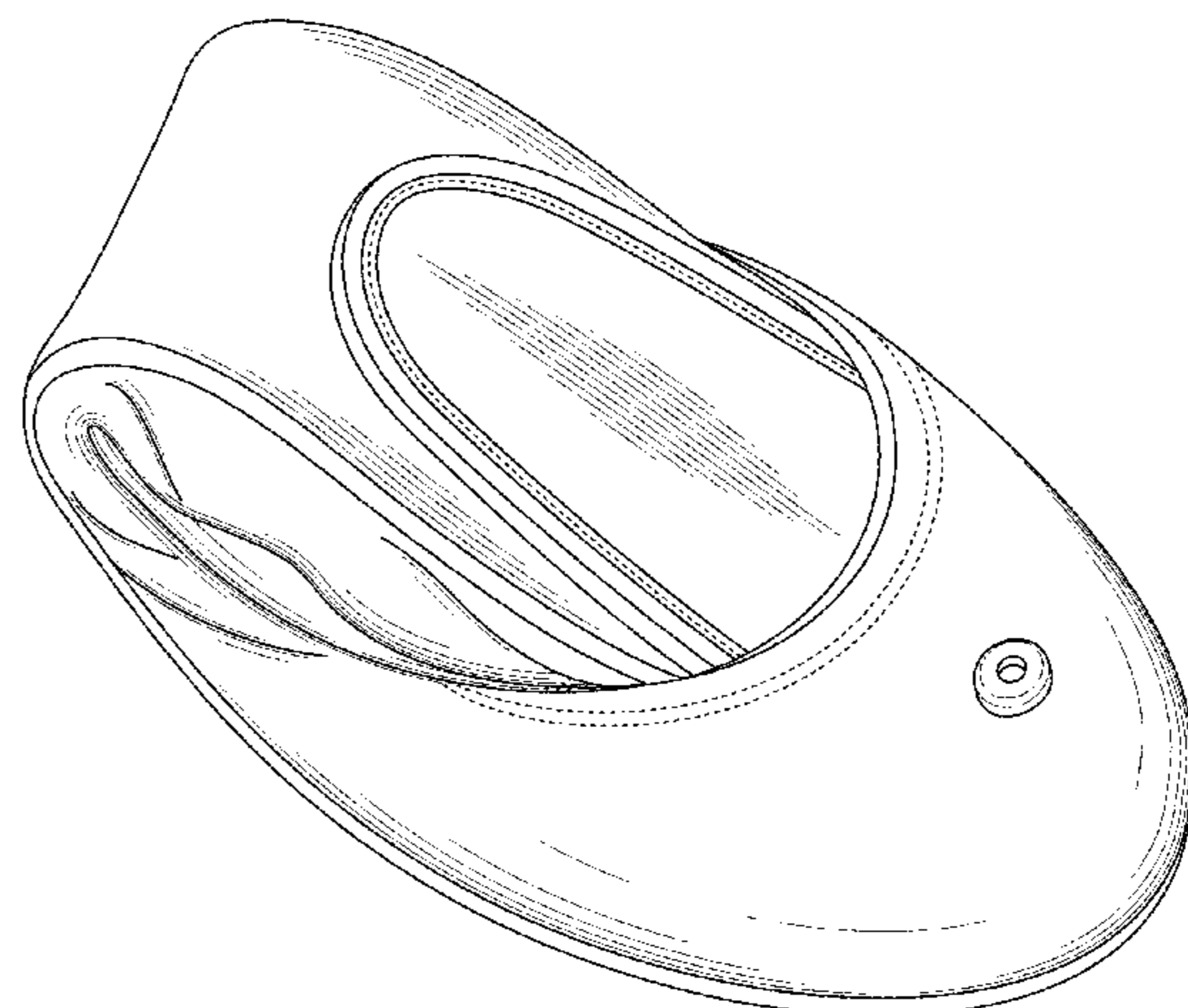
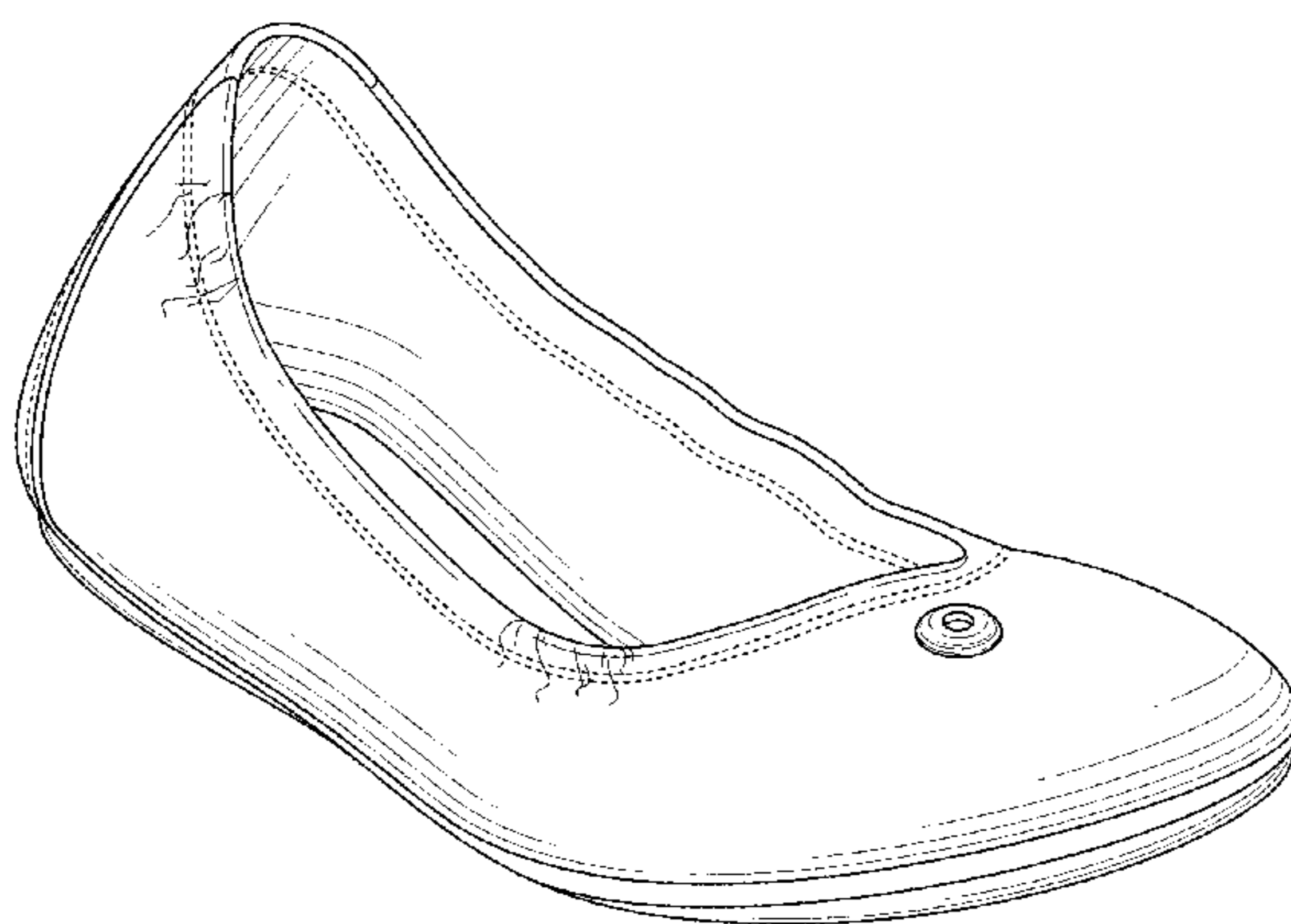

# US D751,280 S

Page 2

---

(56)

## References Cited

### U.S. PATENT DOCUMENTS

D690,915 S \* 10/2013 Gavrieli ..... D2/925  
8,745,893 B2 \* 6/2014 Gavrieli ..... A43B 3/248  
36/102  
D730,030 S \* 5/2015 Della Valle ..... D2/939  
D730,635 S \* 6/2015 Lin ..... D2/939

2009/0193685 A1\* 8/2009 Wilson ..... A43B 3/24  
36/102  
2009/0272009 A1\* 11/2009 Weisner ..... A43B 3/101  
36/102  
2010/0018080 A1\* 1/2010 Smith ..... A43B 3/24  
36/102  
2011/0214312 A1\* 9/2011 Krikelis ..... A43B 3/00  
36/102

\* cited by examiner

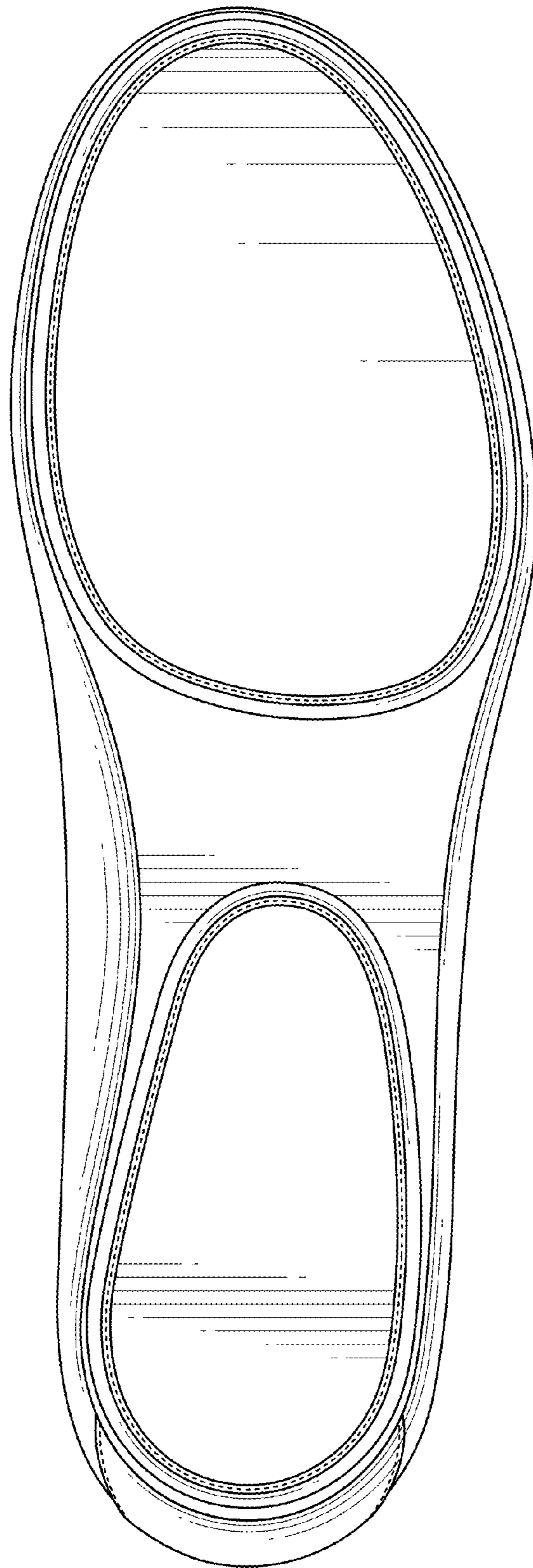

FIG. 1

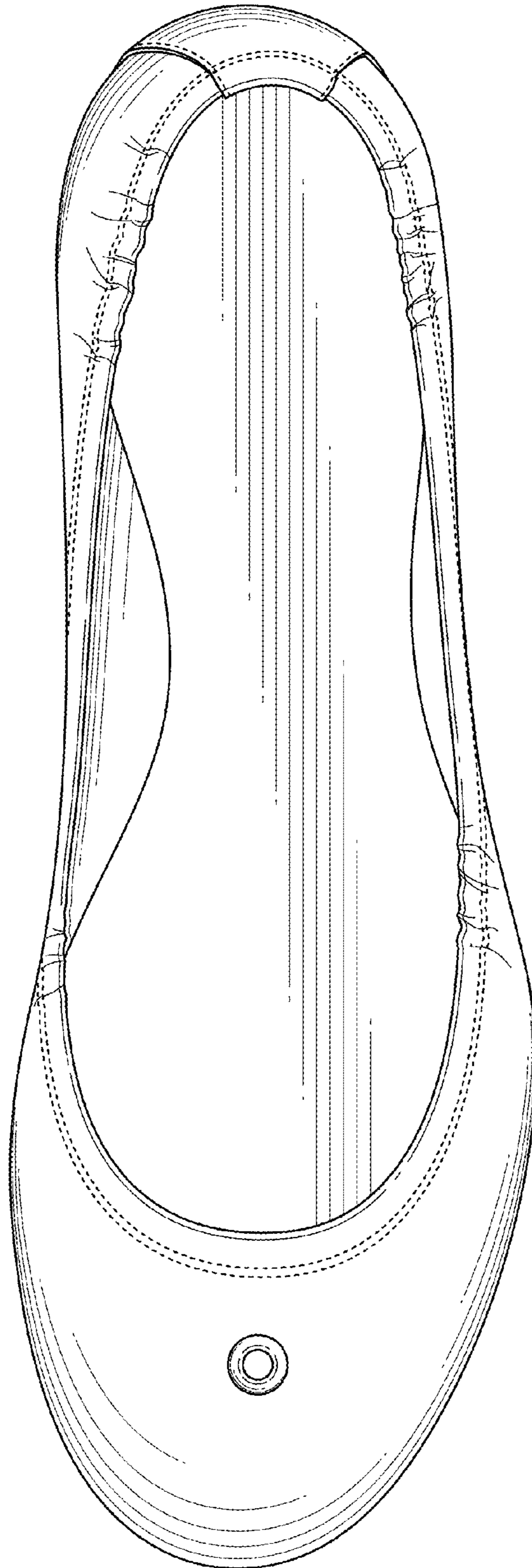

FIG. 2

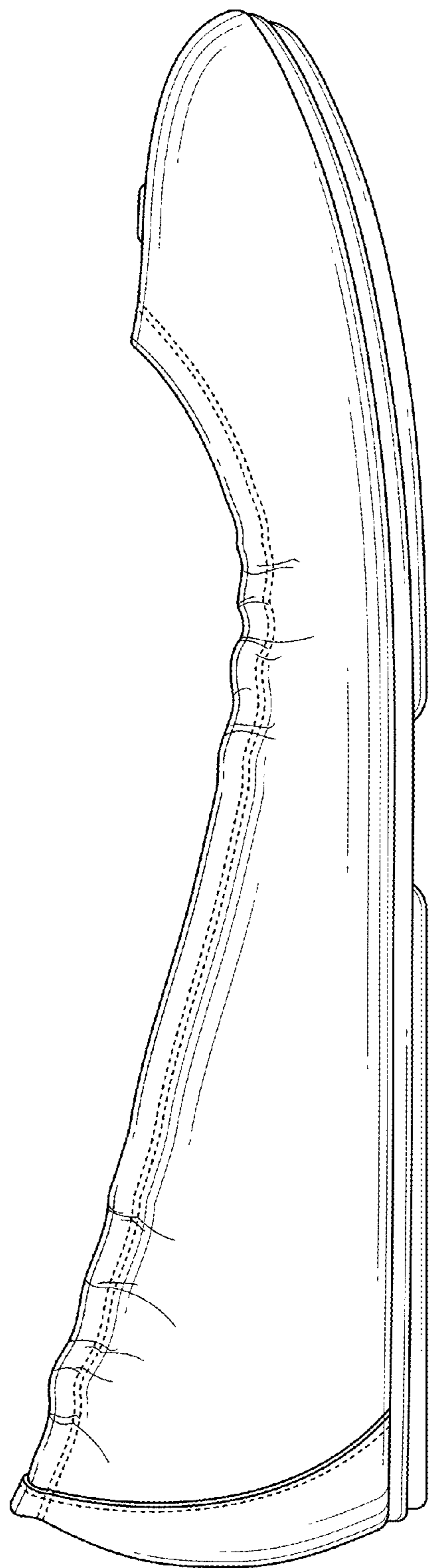

FIG. 3

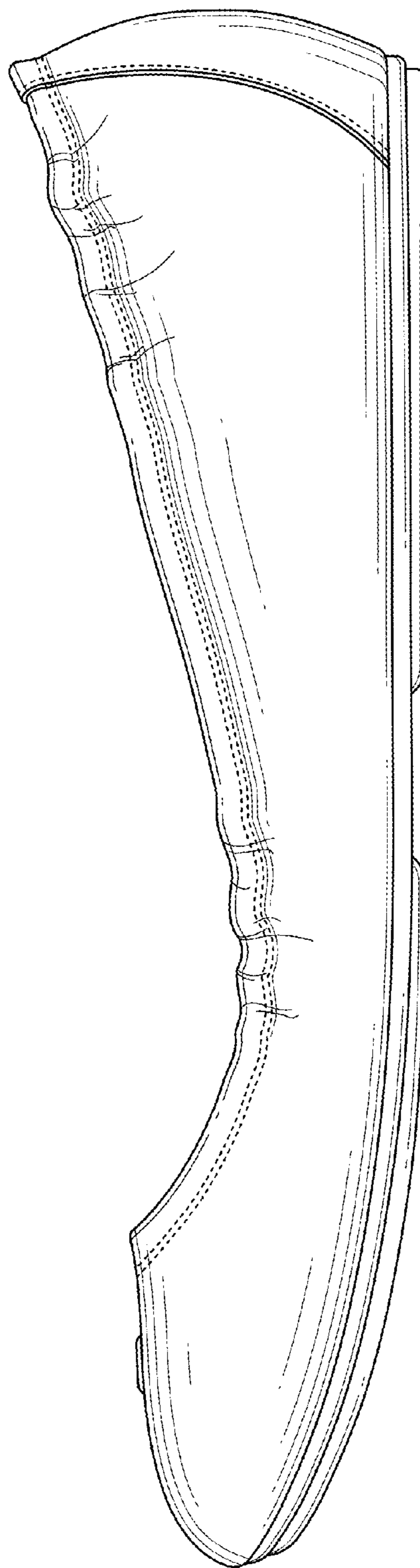

FIG. 4

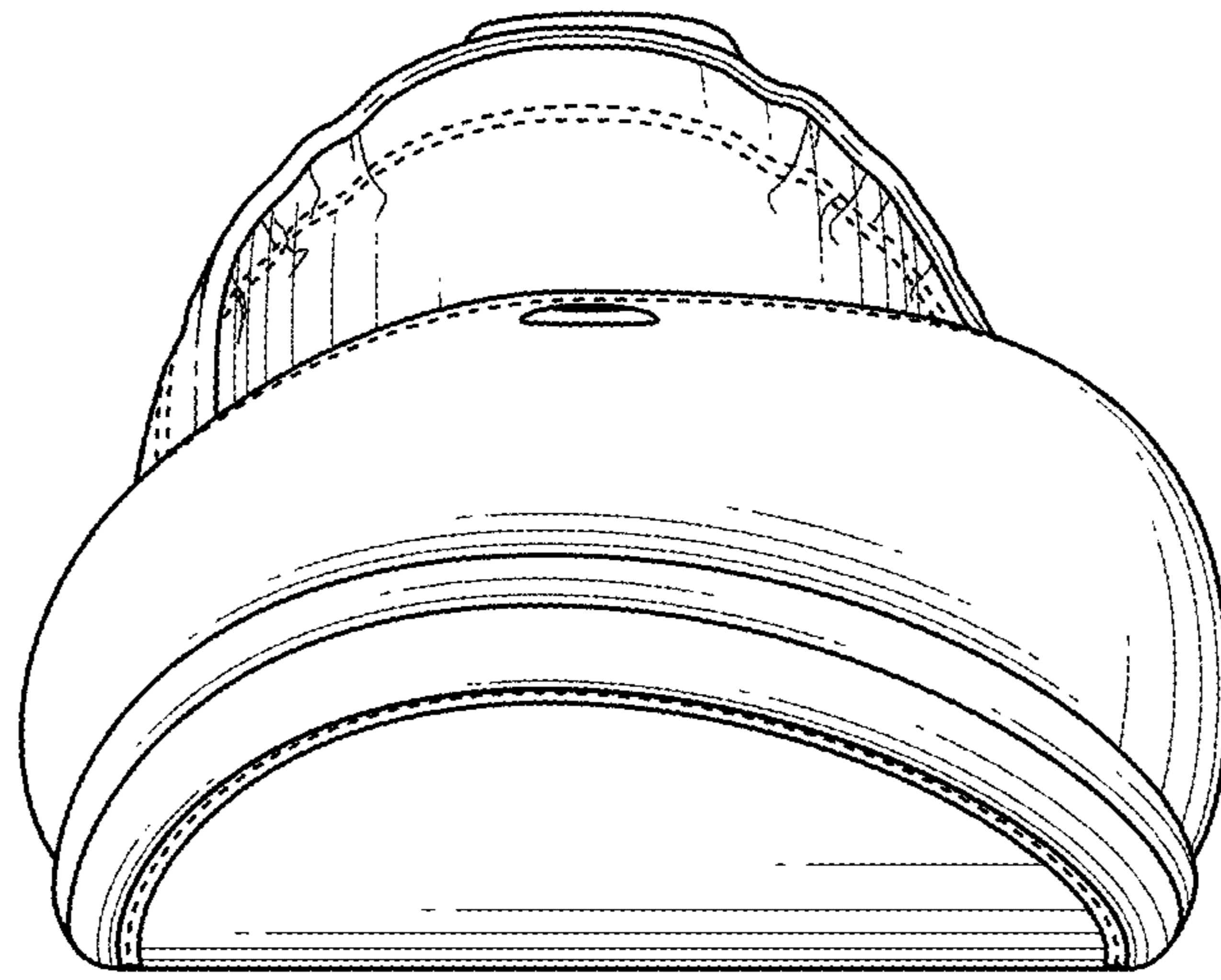

FIG. 5

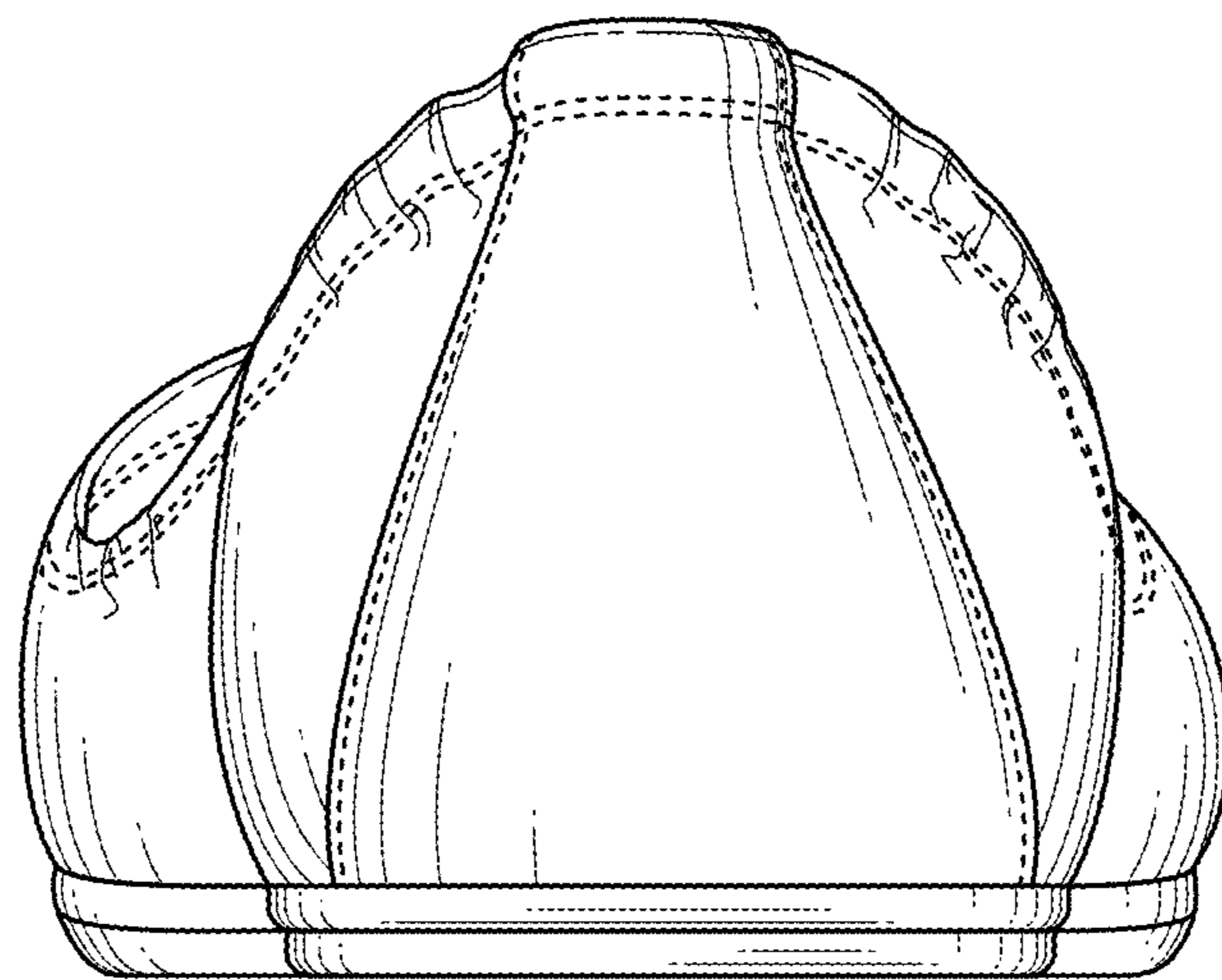

FIG. 6

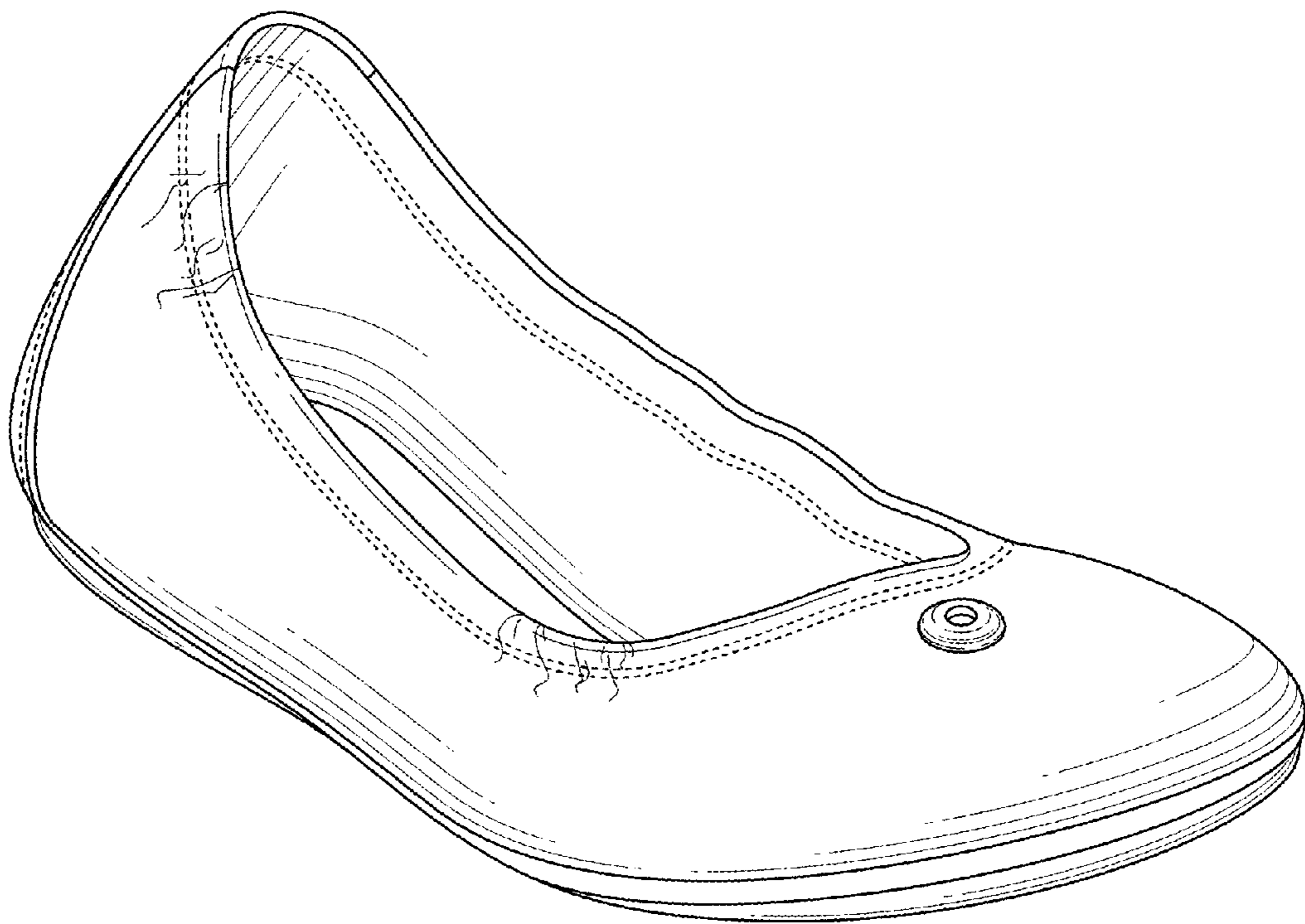

FIG. 7

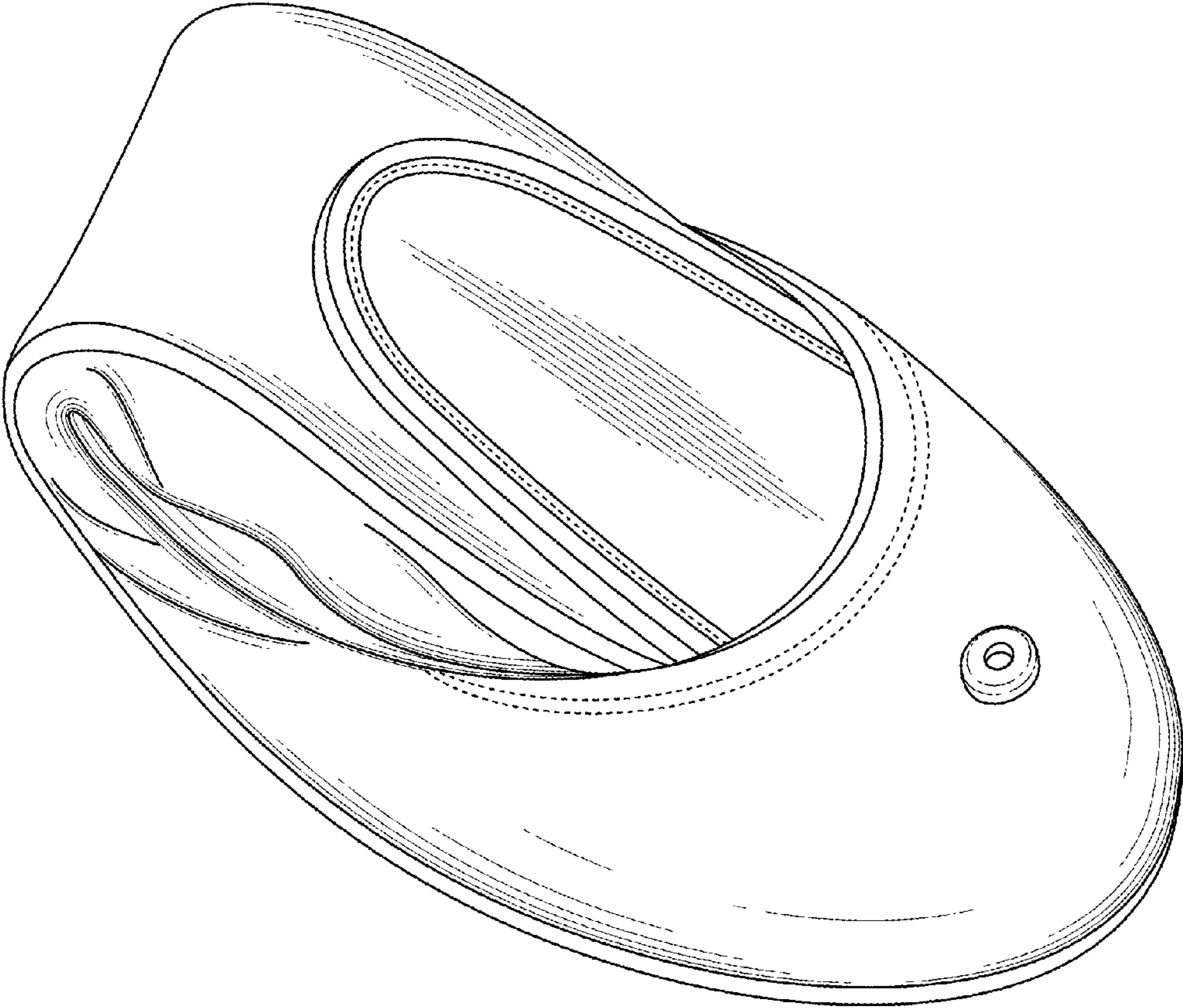

FIG. 8