



US00D751120S

(12) **United States Design Patent**  
**Spindler et al.**

(10) **Patent No.:** **US D751,120 S**  
(45) **Date of Patent:** **\*\* Mar. 8, 2016**

(54) **TIRE INFLATION KIT**

(71) Applicants: **Martin Spindler**,  
Herdwangen-Schönach (DE); **Steffen**  
**Prüser**, Frickingen (DE); **Byron Peter**  
**Hutten**, Owingen (DE); **Brandt Haener**,  
Los Osos, CA (US); **Gordon Chetosky**,  
Hinsdale, IL (US)

(72) Inventors: **Martin Spindler**,  
Herdwangen-Schönach (DE); **Steffen**  
**Prüser**, Frickingen (DE); **Byron Peter**  
**Hutten**, Owingen (DE); **Brandt Haener**,  
Los Osos, CA (US); **Gordon Chetosky**,  
Hinsdale, IL (US)

(73) Assignee: **Illinois Tool Works Inc.**, Glenview, IL  
(US)

(\*\*) Term: **14 Years**

(21) Appl. No.: **29/497,261**

(22) Filed: **Jul. 22, 2014**

**Related U.S. Application Data**

(63) Continuation-in-part of application No. 13/837,857,  
filed on Mar. 15, 2013.

(30) **Foreign Application Priority Data**

Jan. 24, 2014 (DE) ..... 40 2014 100 058

(51) **LOC (10) Cl.** ..... **15-02**

(52) **U.S. Cl.**  
USPC ..... **D15/9**

(58) **Field of Classification Search**

USPC ..... D15/7-9; D23/231, 232, 225; 417/60,  
417/235, 265, 321, 355, 358, 363, 359,  
417/410.1, 415-416, 405, 900, 360;  
60/408, 412; 184/26-37; 415/140-147;  
123/495, 509

CPC ..... F04B 25/00; F04B 27/00; F04B 33/00;  
F04B 35/00; F04B 37/00; F04B 39/00;  
F04B 39/12; F04B 41/00; F04B 7/00; F04B  
9/08; F04B 43/00; F04B 43/04; F04B 43/06  
See application file for complete search history.

(56) **References Cited**

U.S. PATENT DOCUMENTS

D498,769 S \* 11/2004 Chou ..... D15/9  
D499,426 S \* 12/2004 Chou ..... D15/7

(Continued)

FOREIGN PATENT DOCUMENTS

DE 20 2009 002 661 U1 9/2009  
DE 10 2008 033 477 A1 4/2010

(Continued)

*Primary Examiner* — Ralf Seifert

(74) *Attorney, Agent, or Firm* — Pauley Erickson & Kottis

(57) **CLAIM**

The ornamental design for a tire inflation kit, as shown and  
described.

**DESCRIPTION**

FIG. 1 is a top perspective view of a tire inflation kit, accord-  
ing to one preferred embodiment of the invention;  
FIG. 2 is a front view of the tire inflation kit shown in FIG. 1;  
FIG. 3 is a rear view of the tire inflation kit shown in FIG. 1;  
FIG. 4 is a top view of the tire inflation kit shown in FIG. 1;  
FIG. 5 is a bottom view of the tire inflation kit shown in FIG.  
1;  
FIG. 6 is a left side view of the tire inflation kit shown in FIG.  
1;  
FIG. 7 is a right side view of the tire inflation kit shown in FIG.  
1; and,  
FIG. 8 is a top perspective view of the tire inflation kit shown  
in FIG. 1.

The broken lines are included for the purpose of illustrating  
portions of the tire inflation kit that form no part of the  
claimed design.

**1 Claim, 6 Drawing Sheets**

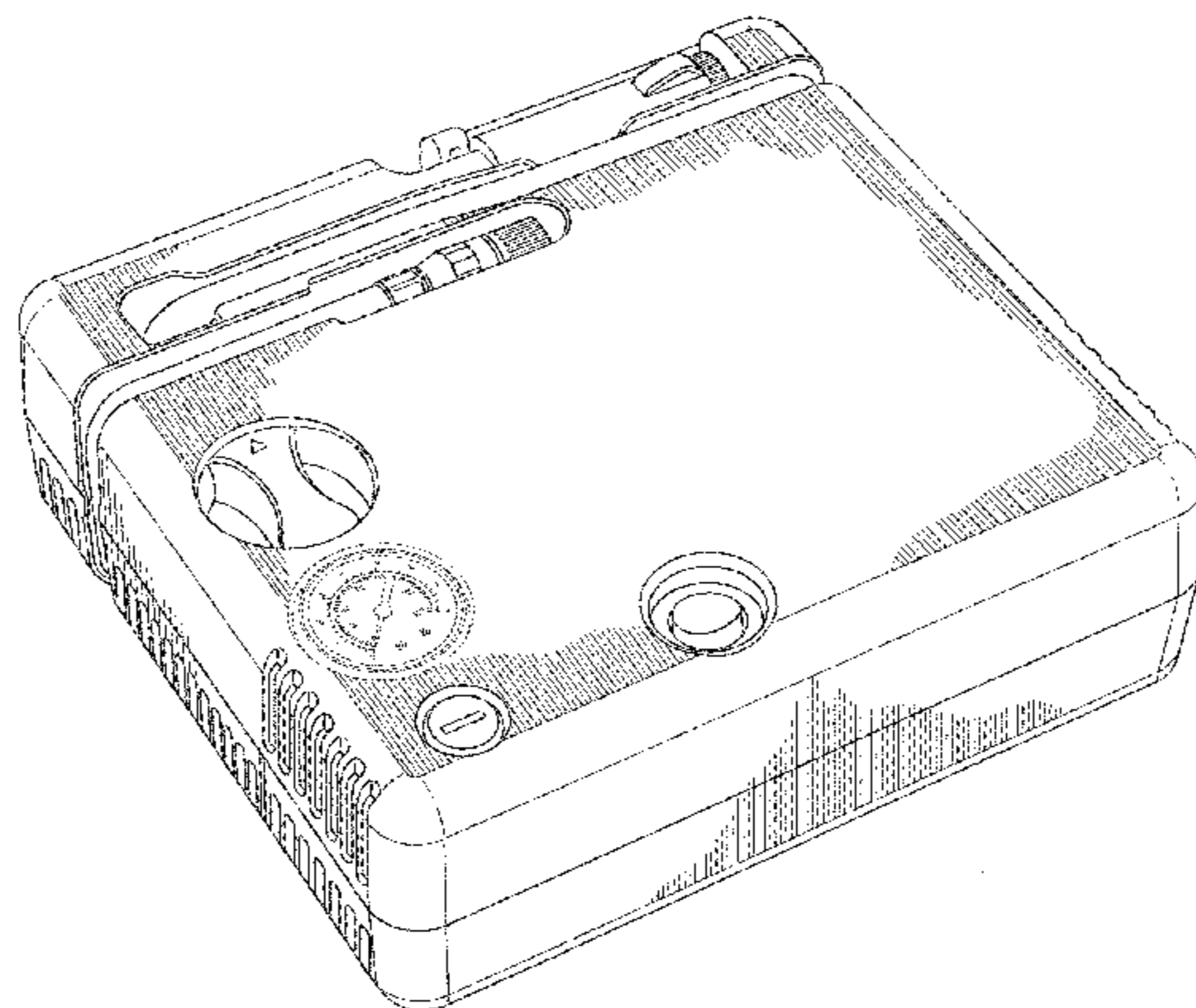

(56)

**References Cited**

U.S. PATENT DOCUMENTS

D626,571 S \* 11/2010 Eckhardt ..... D15/9  
D627,795 S \* 11/2010 Eckhardt ..... D15/9  
D629,424 S \* 12/2010 Eckhardt ..... D15/9  
D644,252 S \* 8/2011 Kojima ..... D15/9  
D657,801 S \* 4/2012 Eckhardt ..... D15/9  
D672,368 S \* 12/2012 Wong ..... D15/9  
D678,351 S \* 3/2013 Wong ..... D15/9  
D679,291 S \* 4/2013 Ohm et al. .... D15/7  
D703,241 S \* 4/2014 Eckhardt et al. .... D15/9  
D722,618 S \* 2/2015 Wong ..... D15/9

D727,972 S \* 4/2015 Jhou ..... D15/9  
D727,973 S \* 4/2015 Jhou ..... D15/9  
2003/0056851 A1 3/2003 Eriksen et al.  
2008/0098855 A1 5/2008 Cegelski et al.

FOREIGN PATENT DOCUMENTS

DE 10 2008 057 827 A1 5/2010  
EP 1 894 707 A1 3/2008  
EP 2 261 011 A1 12/2010  
EP 2 305 570 A1 4/2011

\* cited by examiner

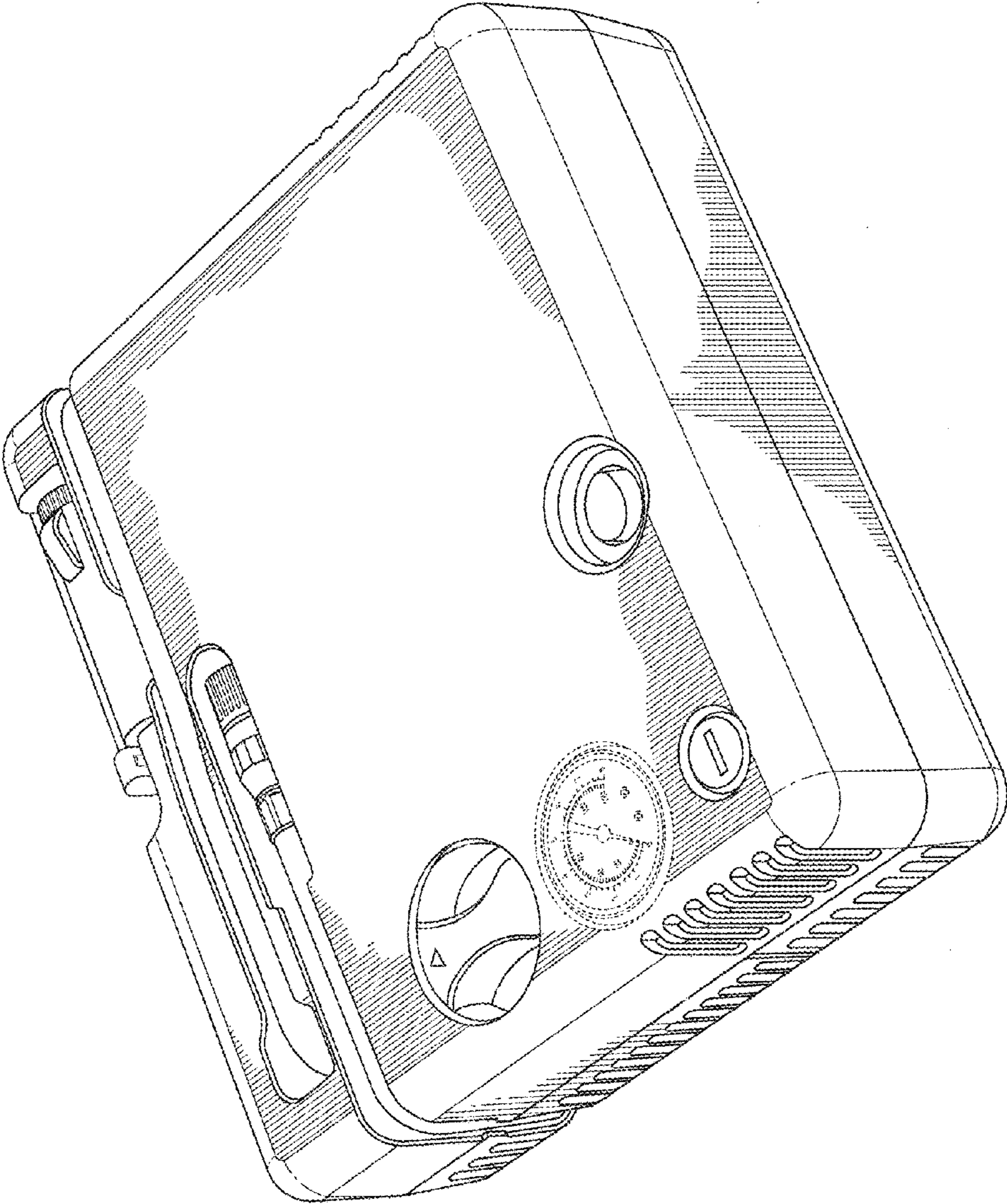

FIG. 1



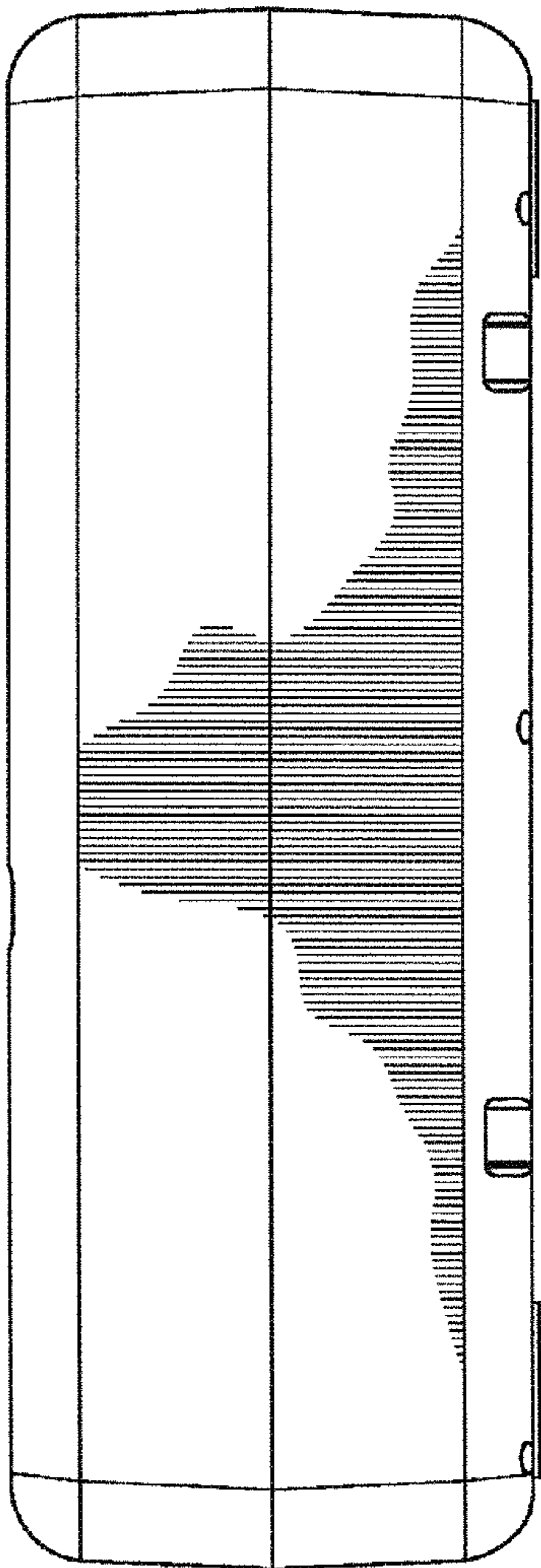

FIG. 2

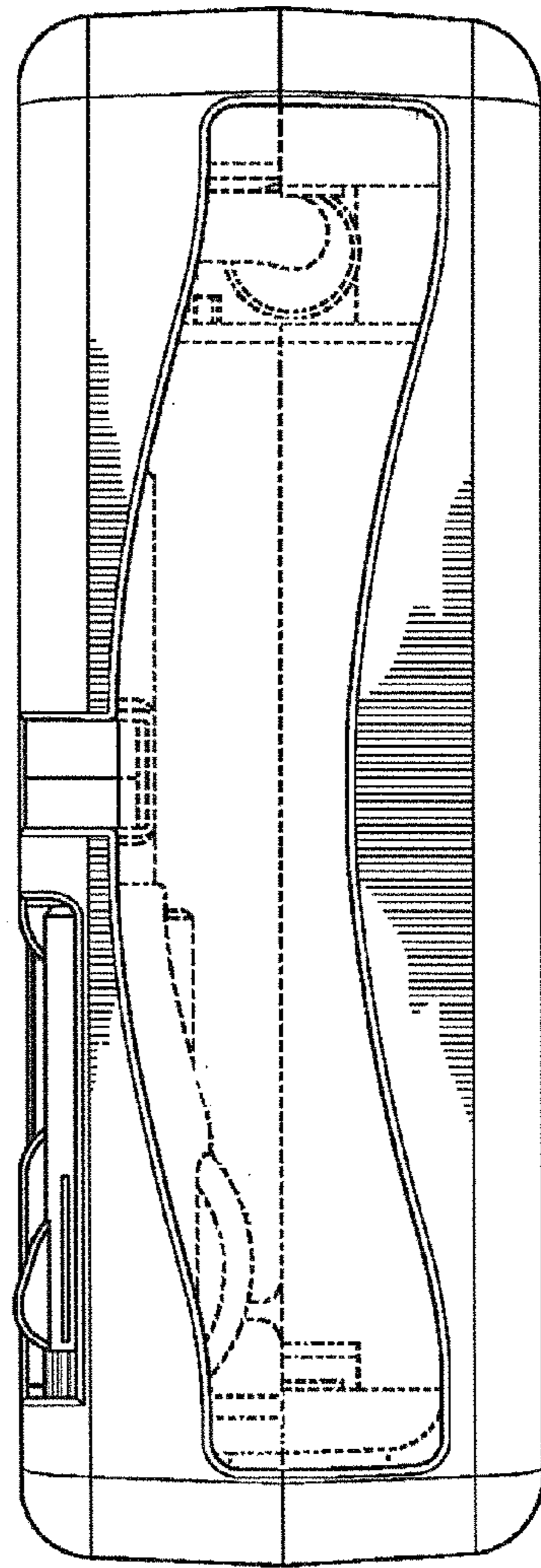

FIG. 3

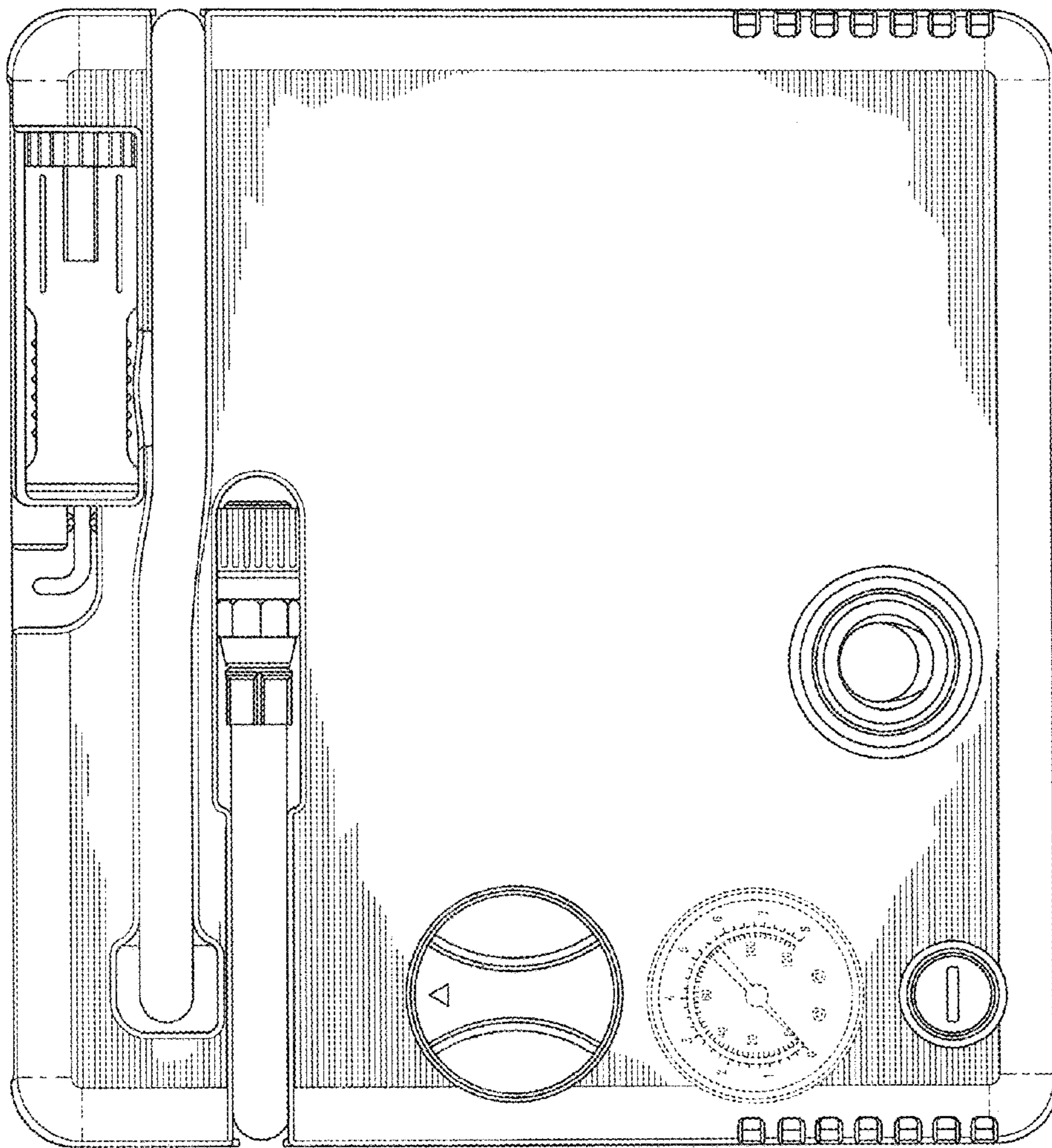

FIG. 4

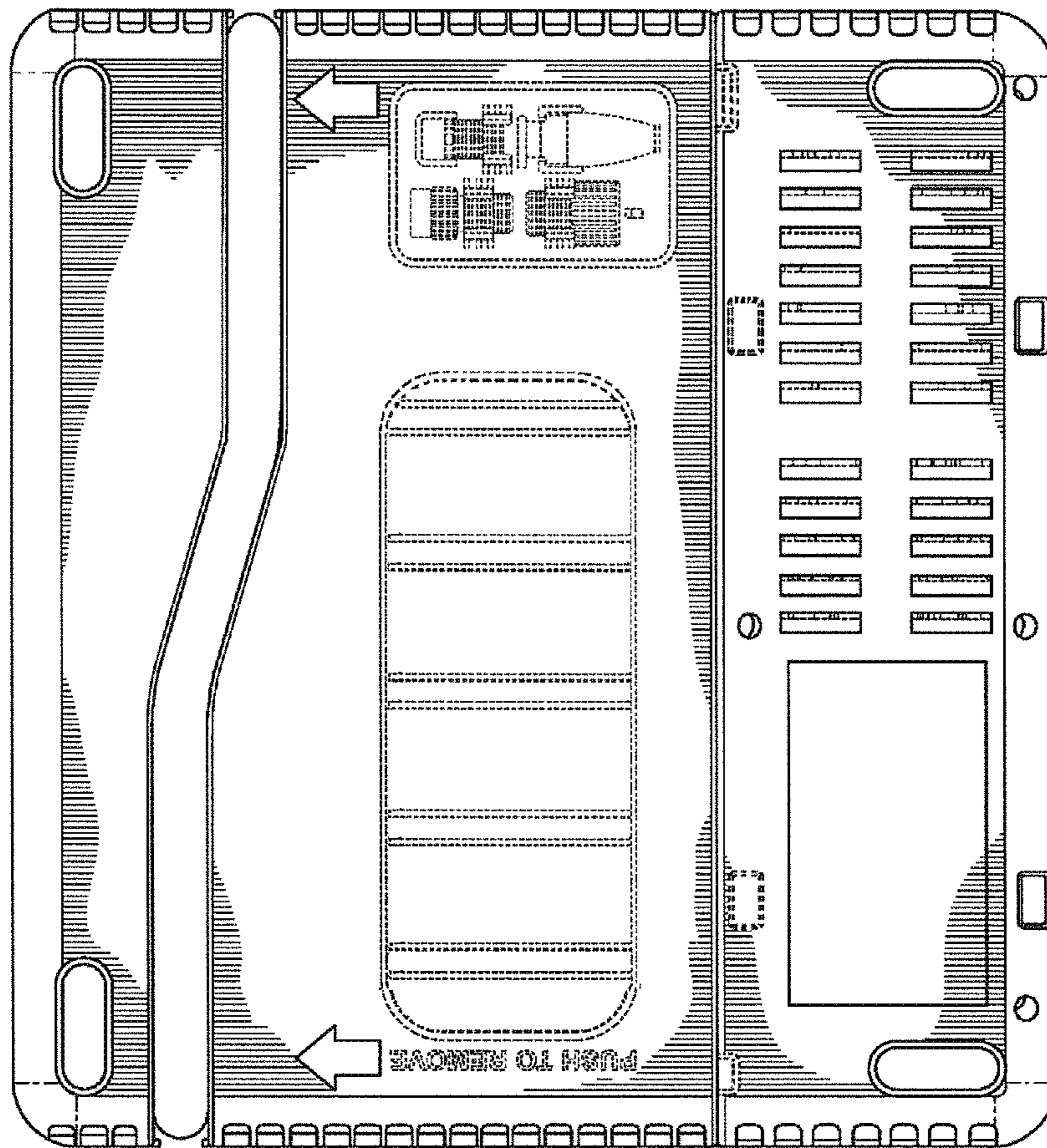

FIG. 5



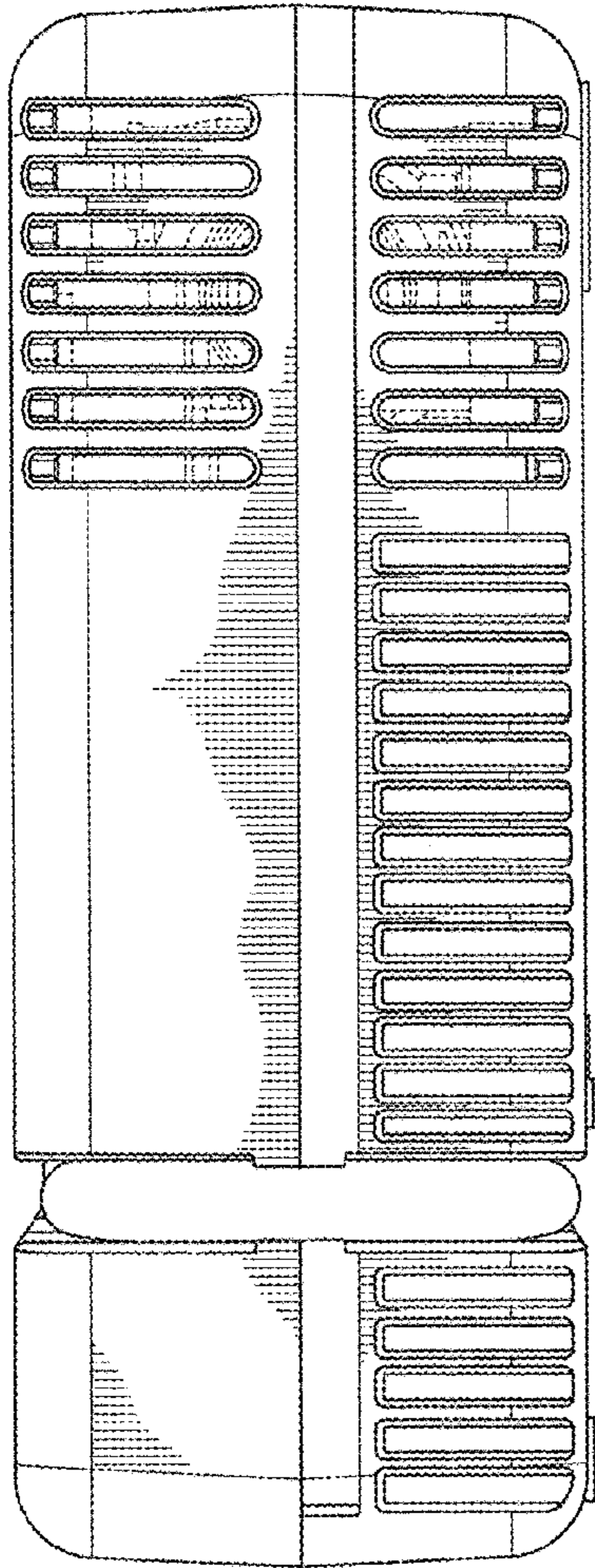

FIG. 6

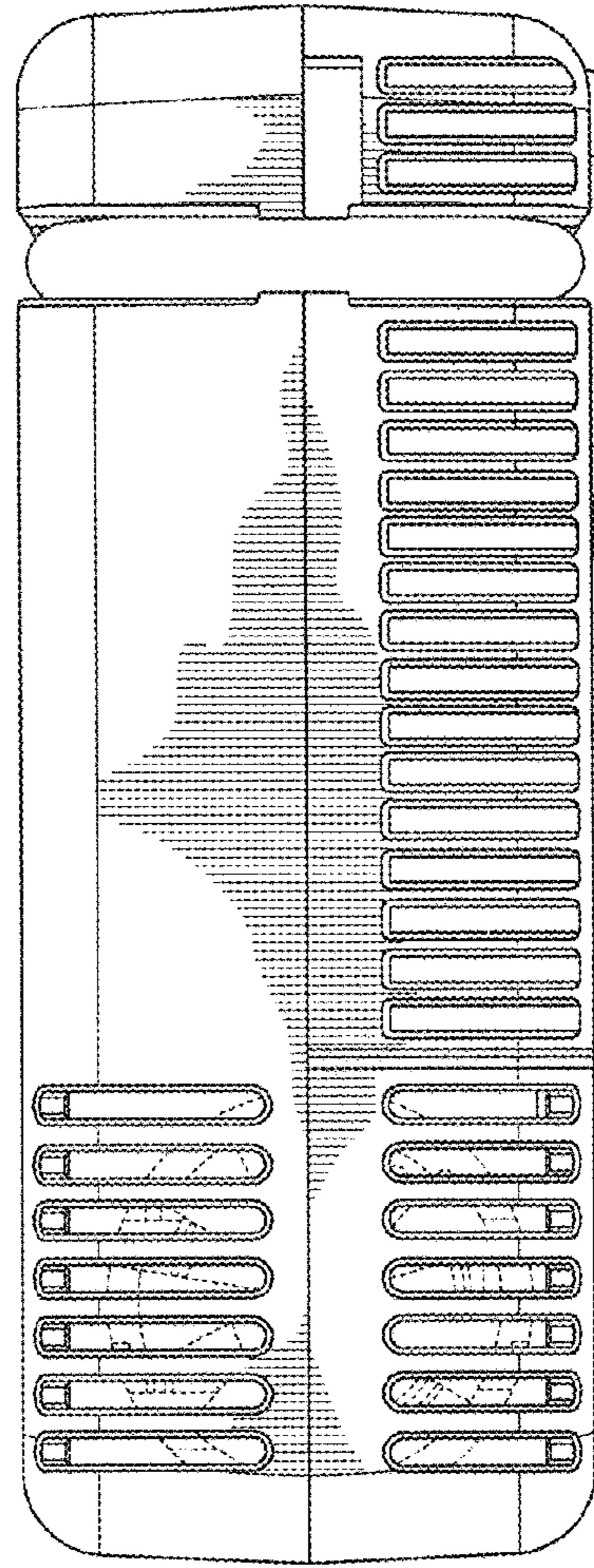

FIG. 7

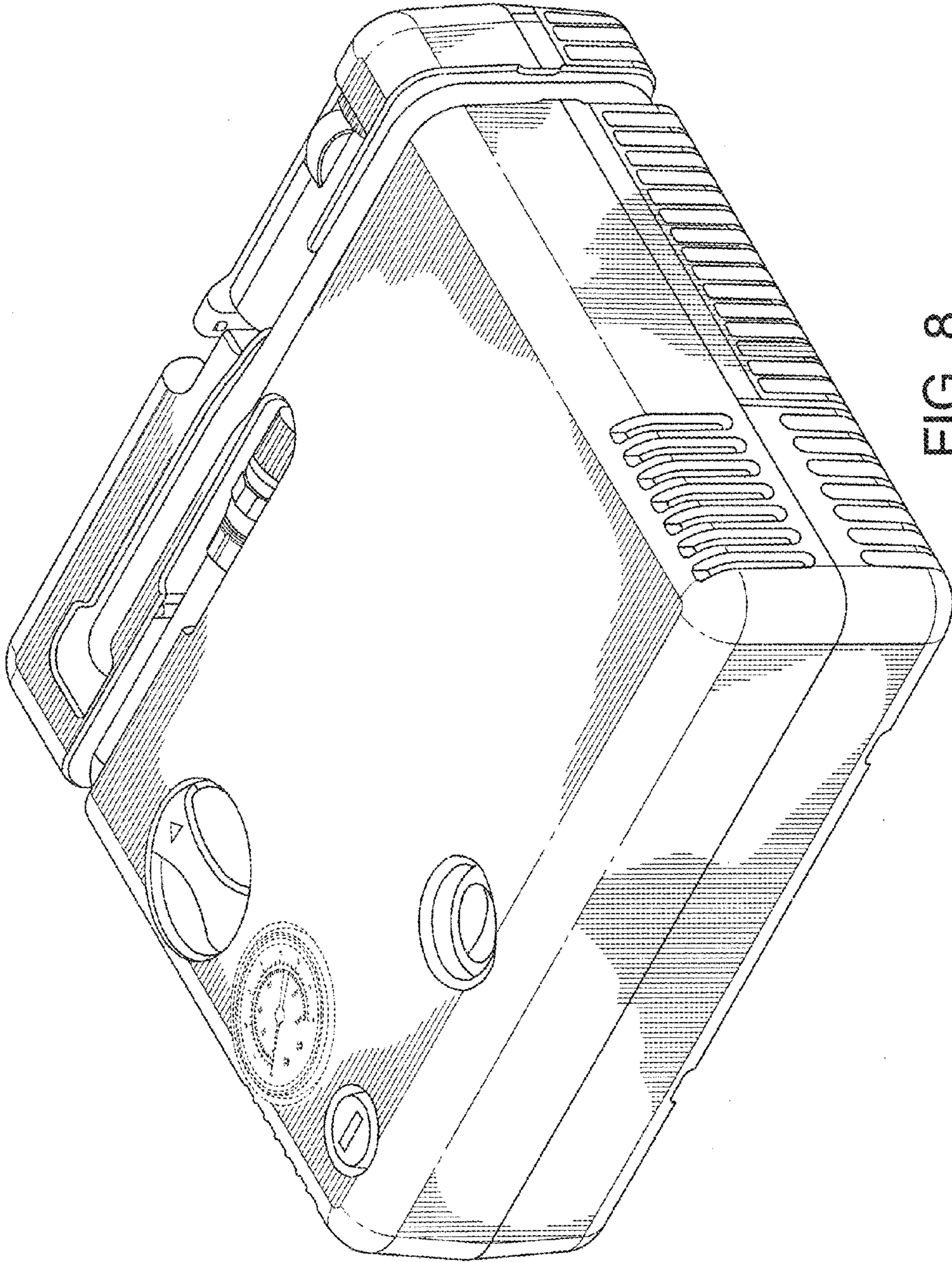

FIG. 8