

US00D751087S

(12) **United States Design Patent**
Phillips et al.

(10) **Patent No.:** **US D751,087 S**
(45) **Date of Patent:** **** Mar. 8, 2016**

(54) **DISPLAY SCREEN WITH ANIMATED GRAPHICAL USER INTERFACE**

(71) Applicants: **Joseph Stanley Phillips**, London (GB); **Andreas Koller**, London (GB); **Maciej Janicki**, London (GB)

(72) Inventors: **Joseph Stanley Phillips**, London (GB); **Andreas Koller**, London (GB); **Maciej Janicki**, London (GB)

(73) Assignee: **Microsoft Corporation**, Redmond, WA (US)

(**) Term: **14 Years**

(21) Appl. No.: **29/488,070**

(22) Filed: **Apr. 15, 2014**

(51) **LOC (10) Cl.** **14-04**

(52) **U.S. Cl.**
USPC **D14/485**

(58) **Field of Classification Search**
USPC D14/344, 485–495; D20/11, 23;
715/700, 702, 715, 726, 739, 963
CPC G06F 3/04817
See application file for complete search history.

(56) **References Cited**

U.S. PATENT DOCUMENTS

D633,150	S *	2/2011	Tesnar	D20/23
D638,441	S *	5/2011	Ording	D14/489
D683,737	S *	6/2013	Brinda	D14/485
D694,254	S *	11/2013	Brinda	D14/485
8,635,545	B2 *	1/2014	Kim	G06F 3/0488 715/764
D700,617	S *	3/2014	Brinda	D14/485
D717,810	S *	11/2014	Larsen	D14/485
D728,618	S *	5/2015	Bae	D14/492
D734,344	S *	7/2015	Clare	D14/485
2002/0007487	A1 *	1/2002	Matsumoto	G06F 3/0482 725/37
2012/0150970	A1 *	6/2012	Peterson	G06F 3/04817 709/206

2013/0159903	A1 *	6/2013	Yu	G06F 3/0482 715/765
2014/0133640	A1 *	5/2014	Cadiz	H04M 1/2473 379/100.01
2015/0033121	A1 *	1/2015	Park-Ekecs	G06F 3/017 715/702

OTHER PUBLICATIONS

‘CALayerAnimTest Floating Cloud’. Youtube.com [online]. Jan. 3, 2011 [retrieved on Oct. 8, 2015]. Retrieved from the Internet: <URL: <https://www.youtube.com/watch?v=n58mcRTmmD8>>.*

* cited by examiner

Primary Examiner — Eric Goodman

Assistant Examiner — Megan K Majcher Hartnett

(74) *Attorney, Agent, or Firm* — Banner & Witcoff, Ltd.

(57) **CLAIM**

The ornamental design for a display screen with animated graphical user interface, as shown and described.

DESCRIPTION

FIG. 1 is the first image in a sequence for a display screen with animated graphical user interface showing my/our new design;

FIG. 2 is the second image thereof;

FIG. 3 is the third image thereof;

FIG. 4 is the fourth image thereof;

FIG. 5 is the fifth image thereof;

FIG. 6 is the sixth image thereof;

FIG. 7 is the seventh image thereof;

FIG. 8 is the eighth image thereof;

FIG. 9 is the ninth image thereof;

FIG. 10 is the tenth image thereof;

FIG. 11 is the eleventh image thereof;

FIG. 12 is the twelfth image thereof;

FIG. 13 is the thirteenth image thereof; and,

FIG. 14 is the fourteenth image thereof.

The appearance of the animated graphical user interface sequentially transitions between the images shown in FIGS. 1-14. The process or period in which one image transitions to another forms no part of the claimed design. The broken line showing of the text, various icons, the remainder of the graphical user interface and the remainder of the display screen is for environmental purposes only and forms no part of the claimed design.

1 Claim, 14 Drawing Sheets

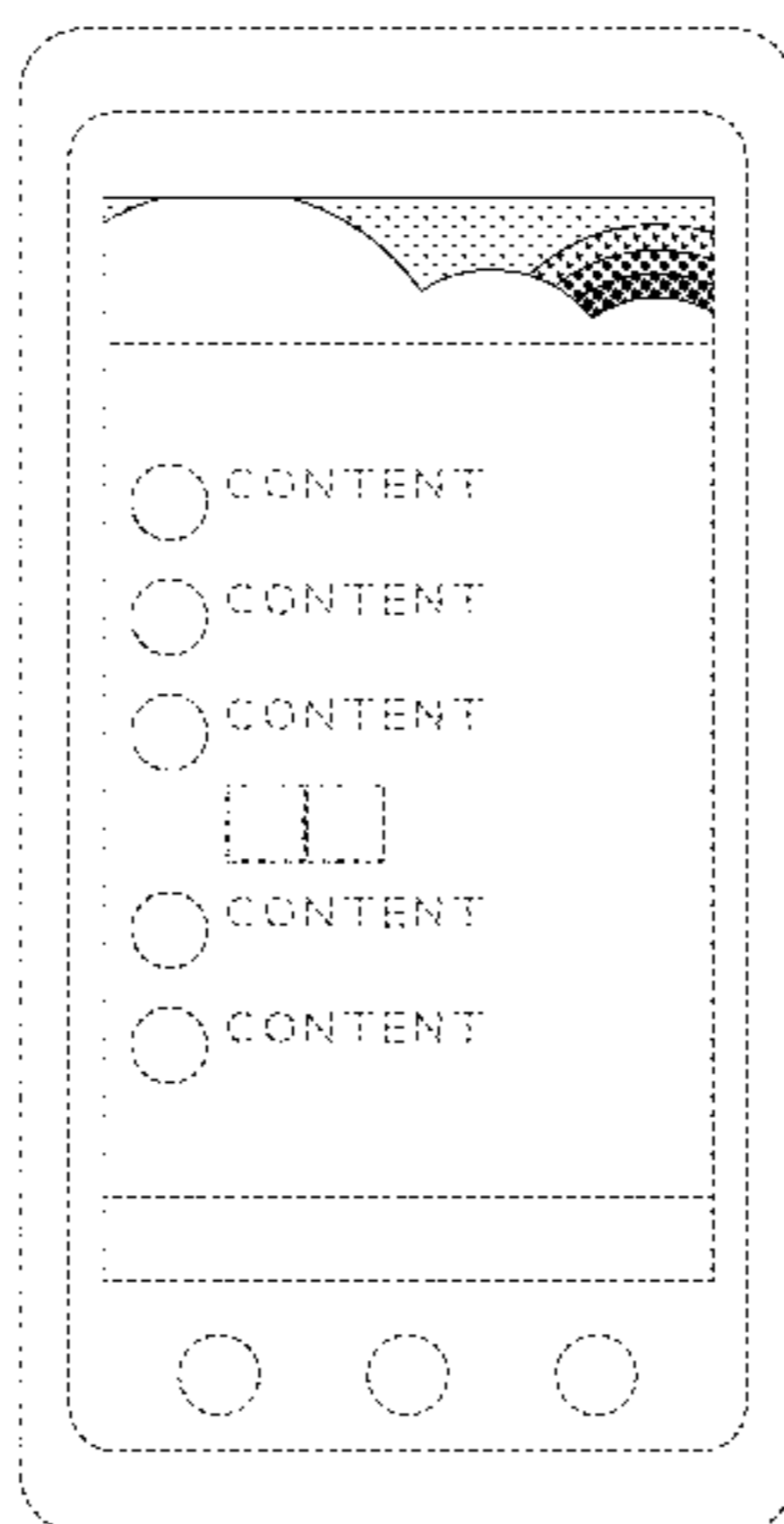

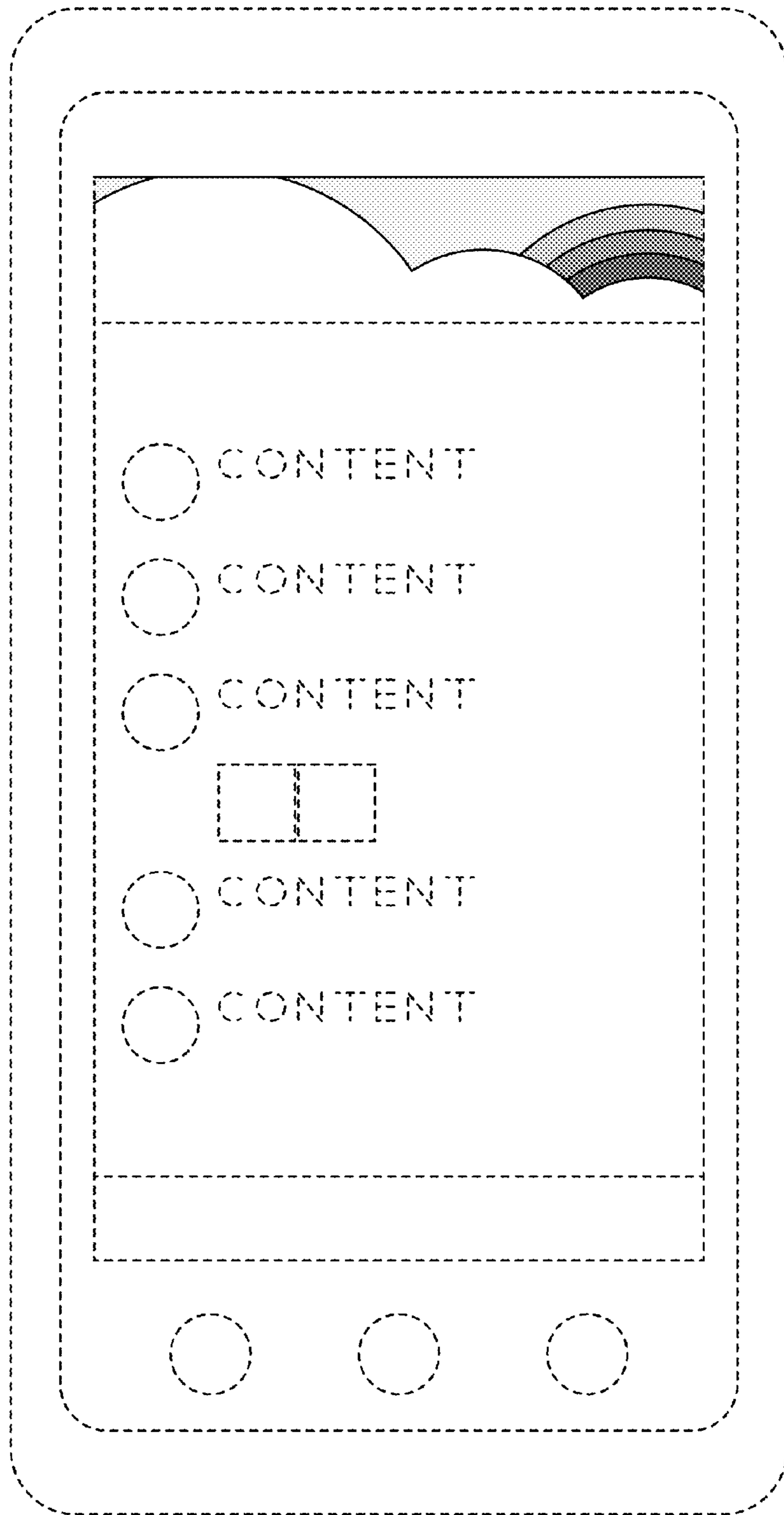
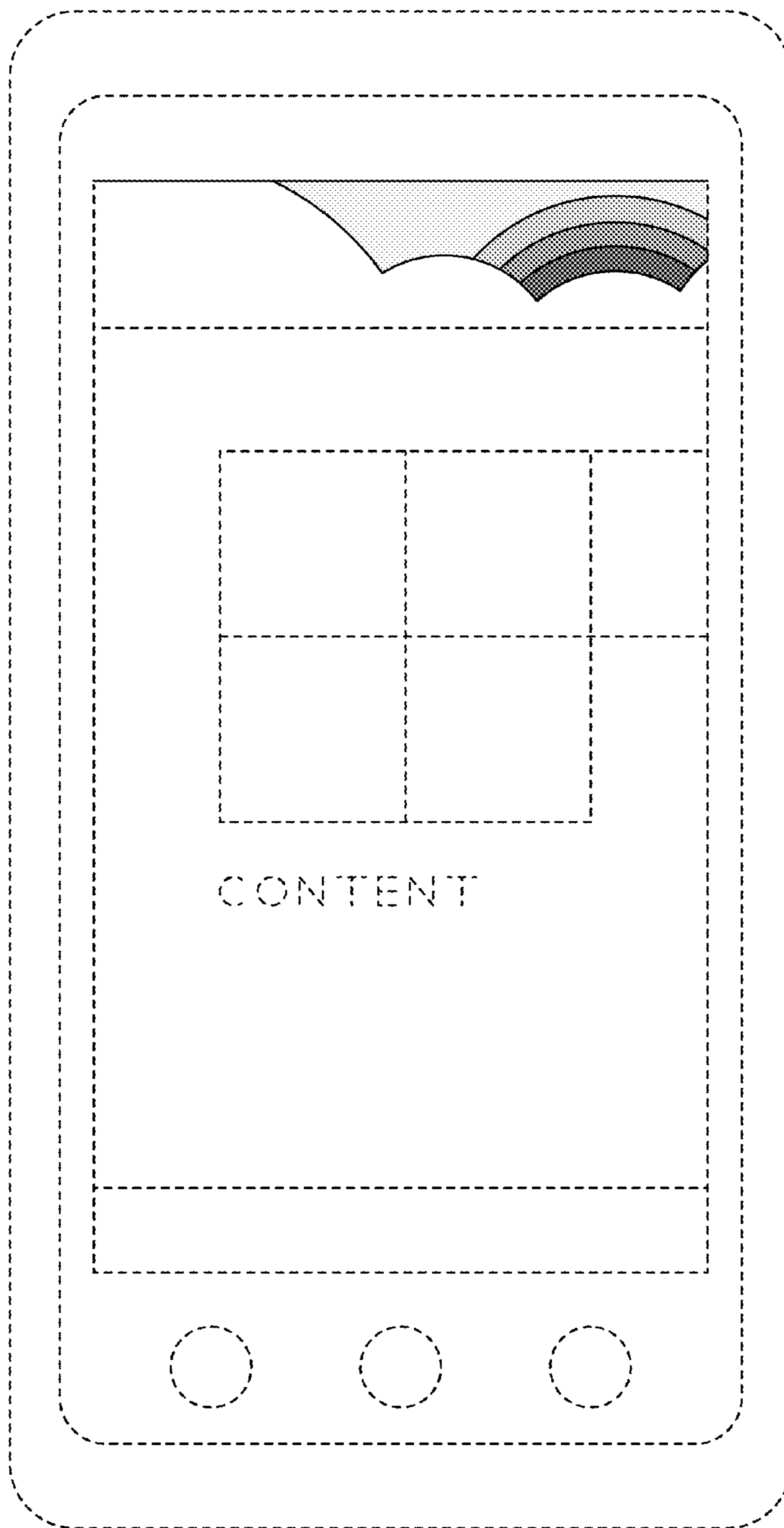

FIG. 1



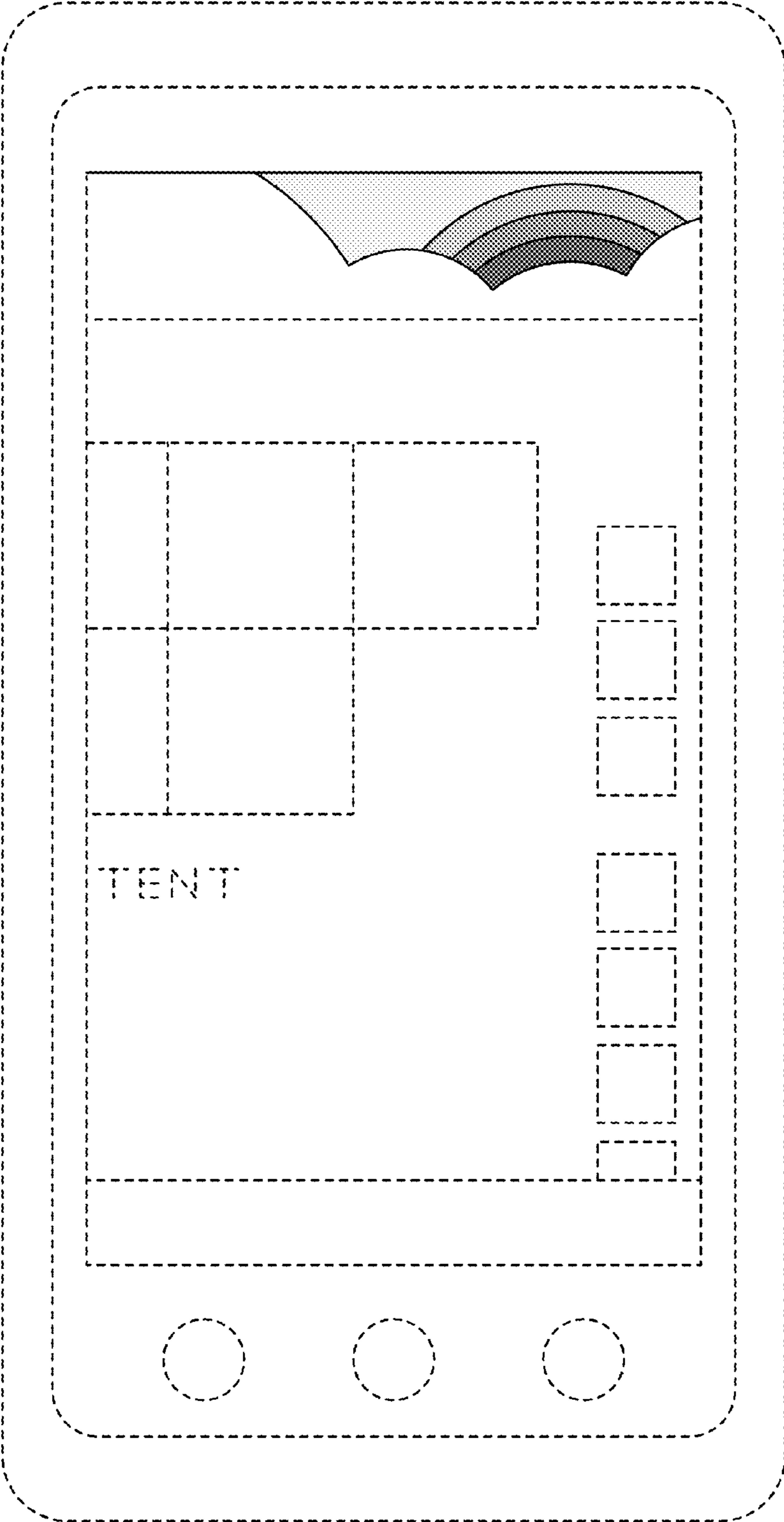

FIG. 3

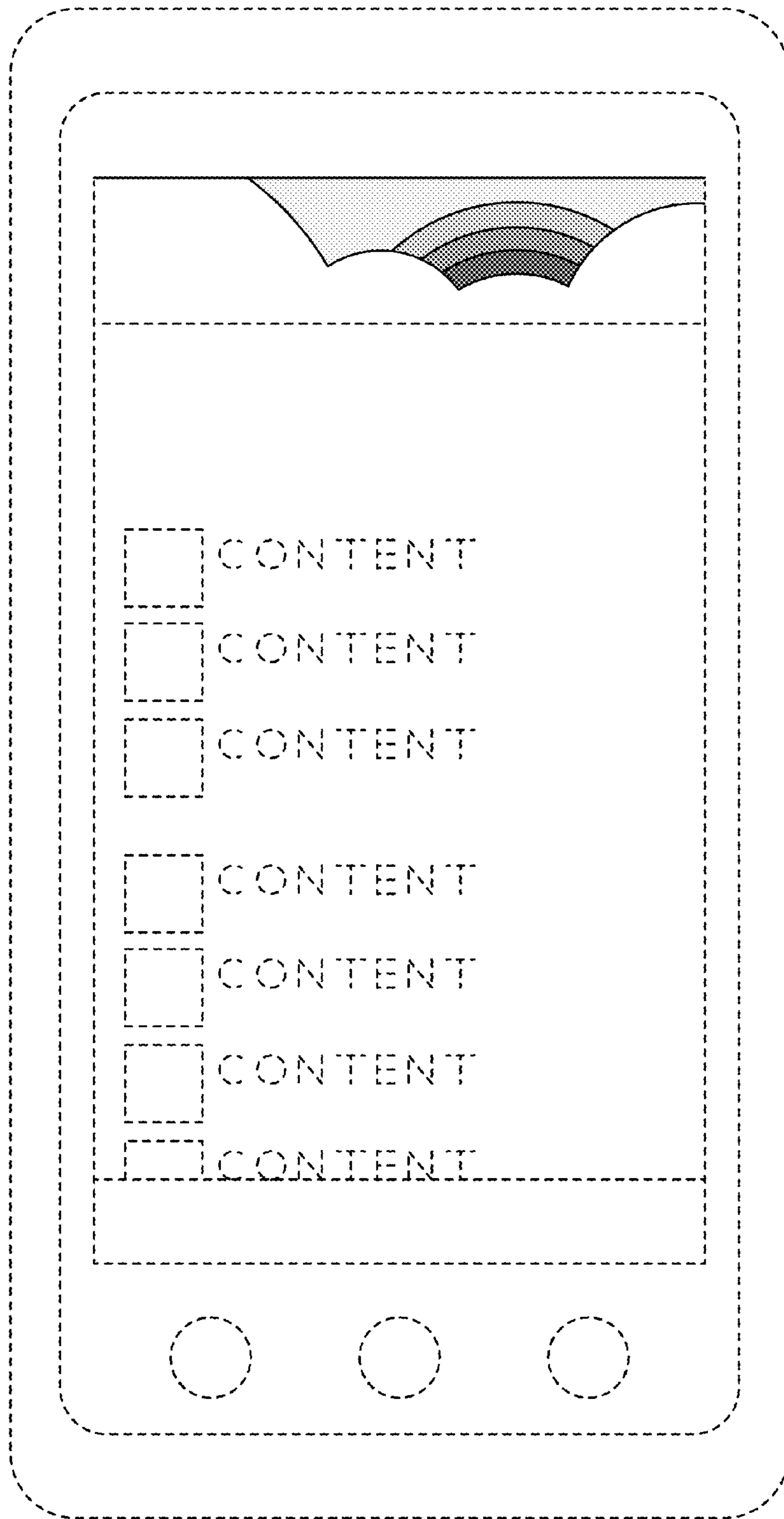

FIG. 4

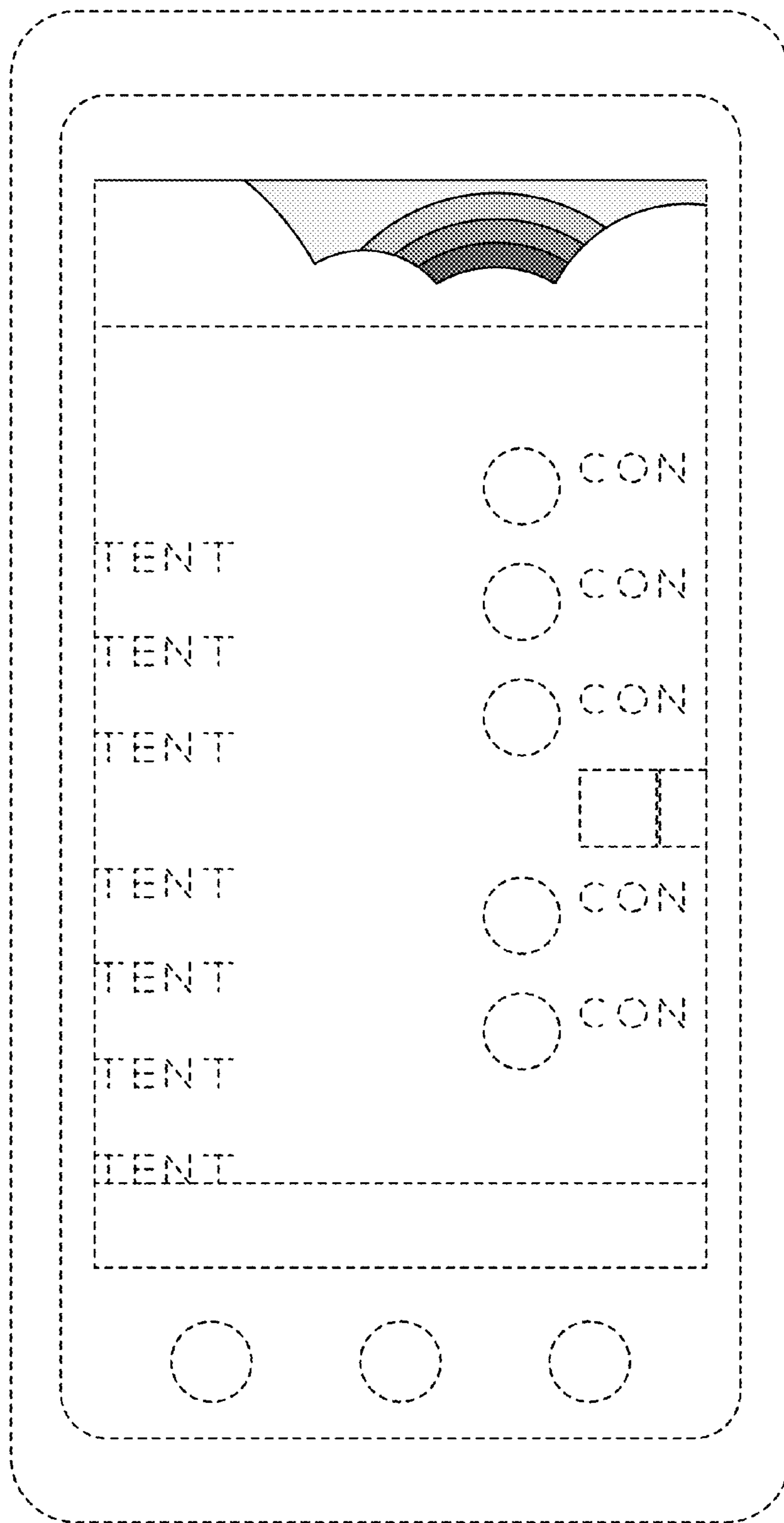

FIG. 5

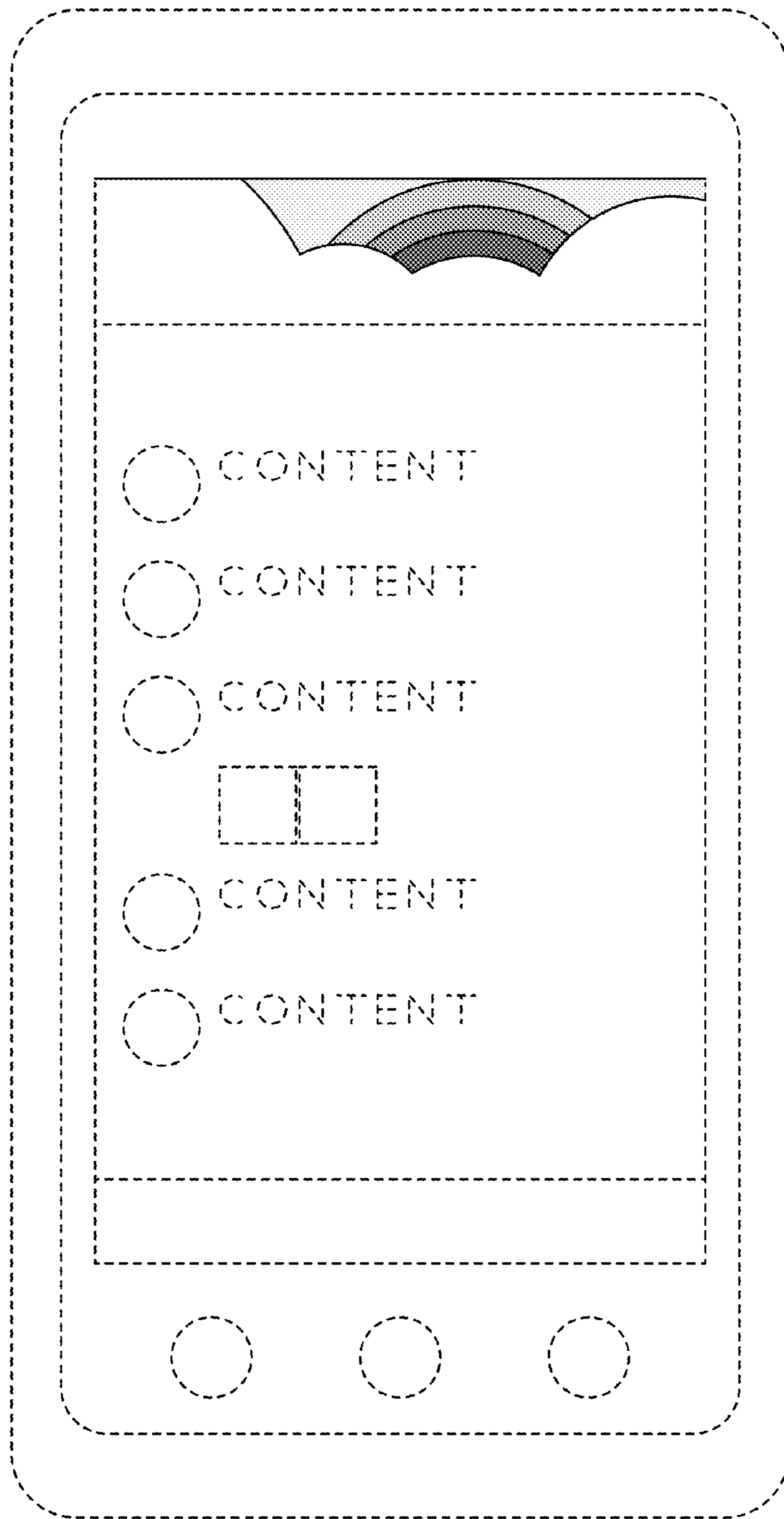

FIG. 6

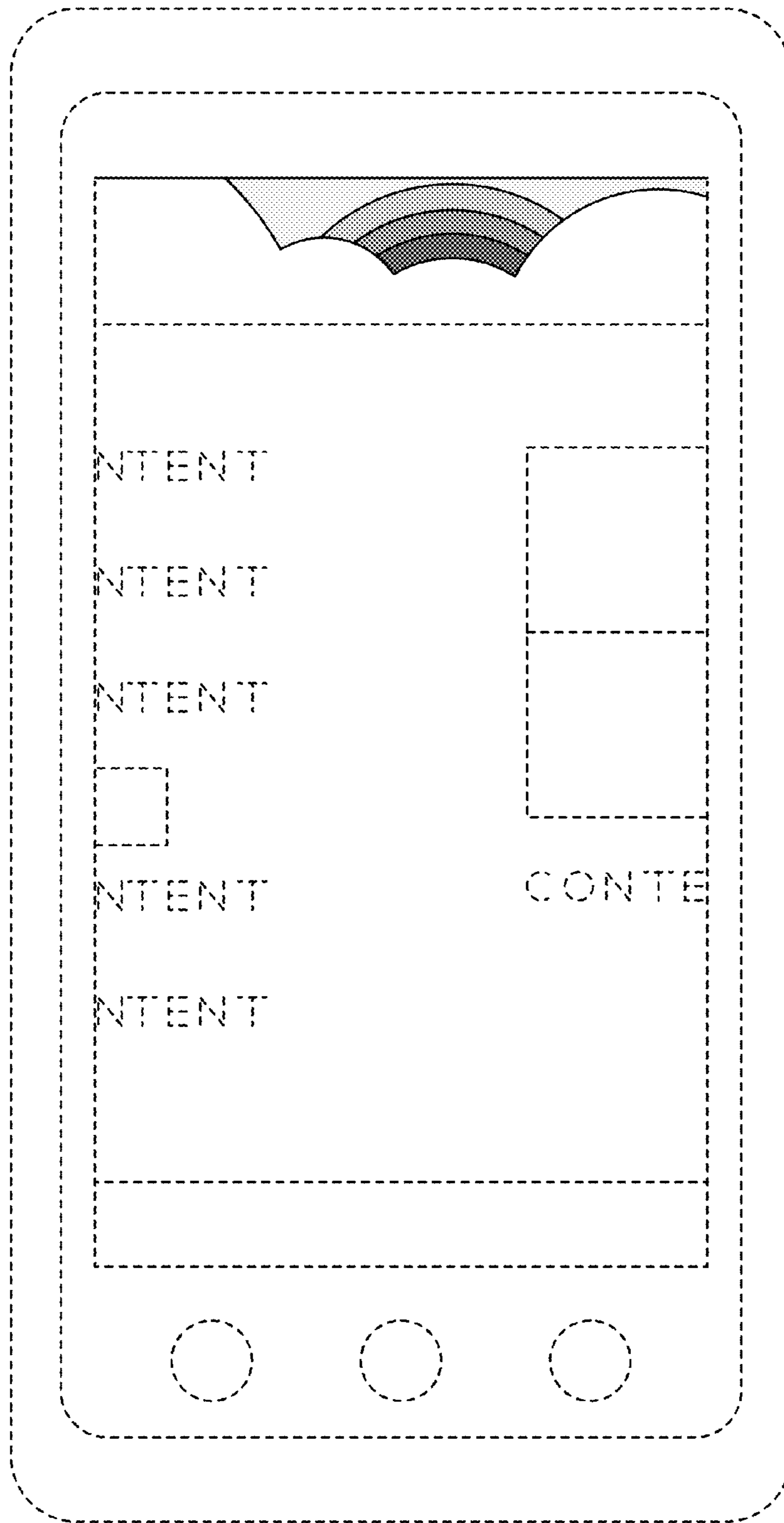

FIG. 7

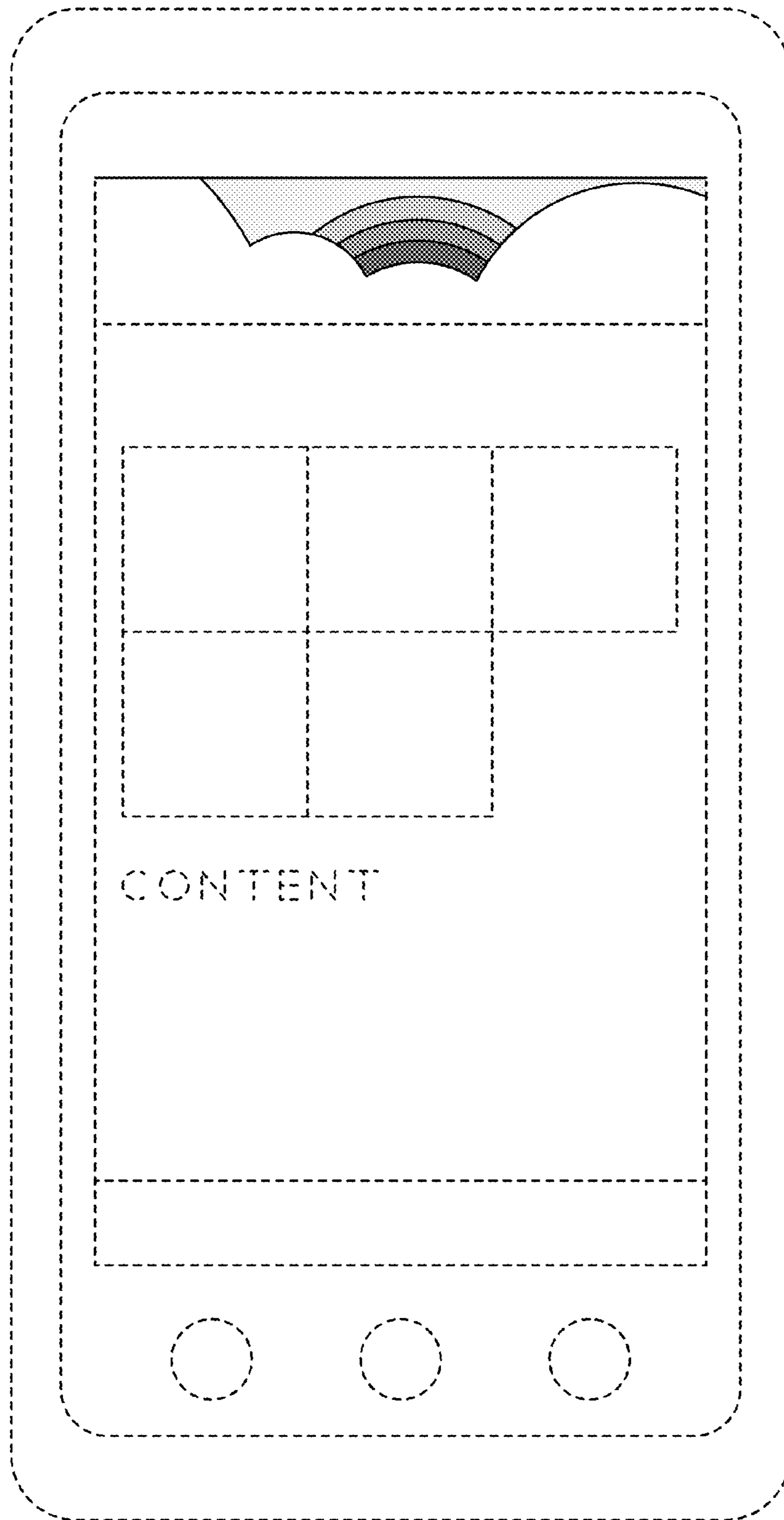

FIG. 8

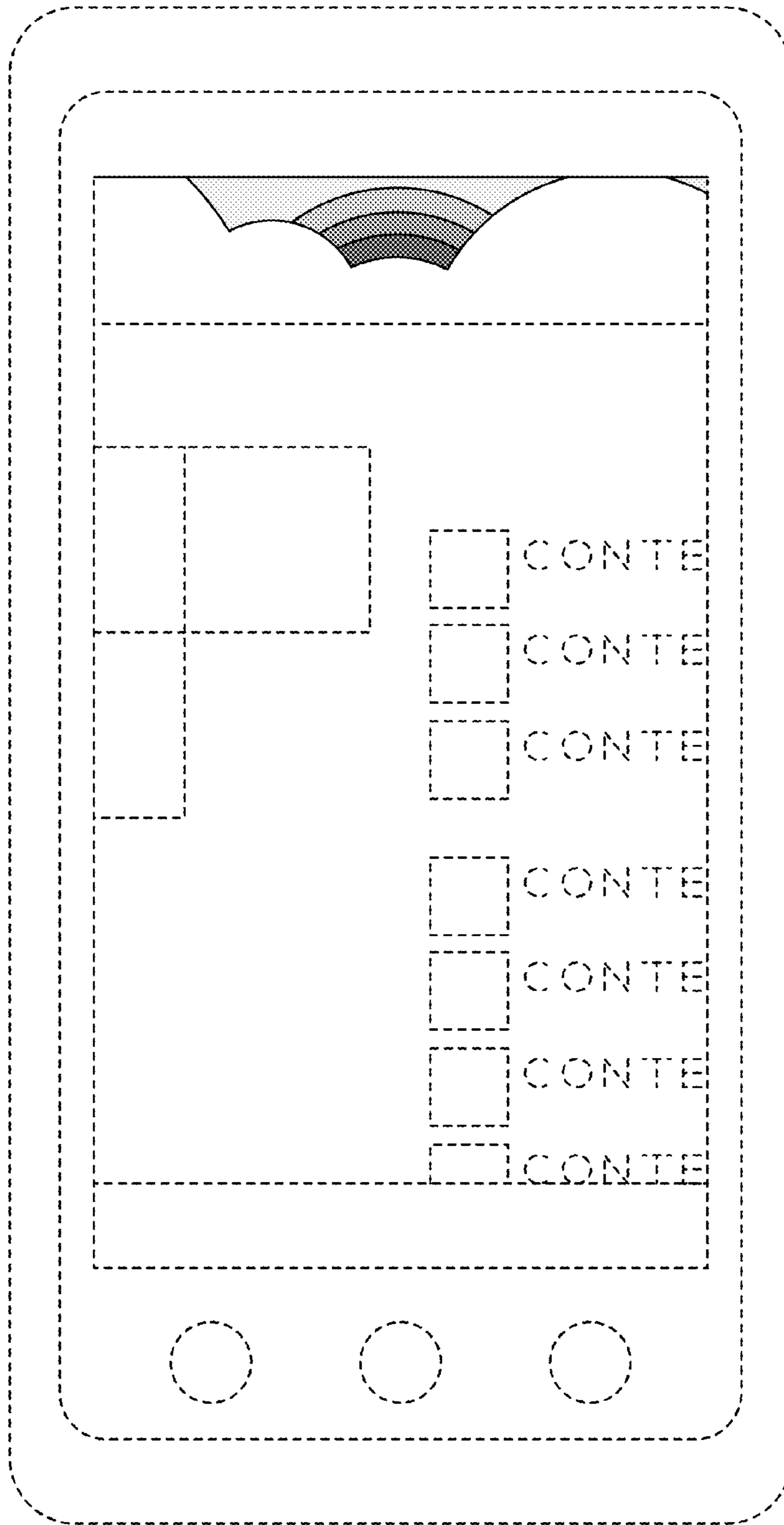
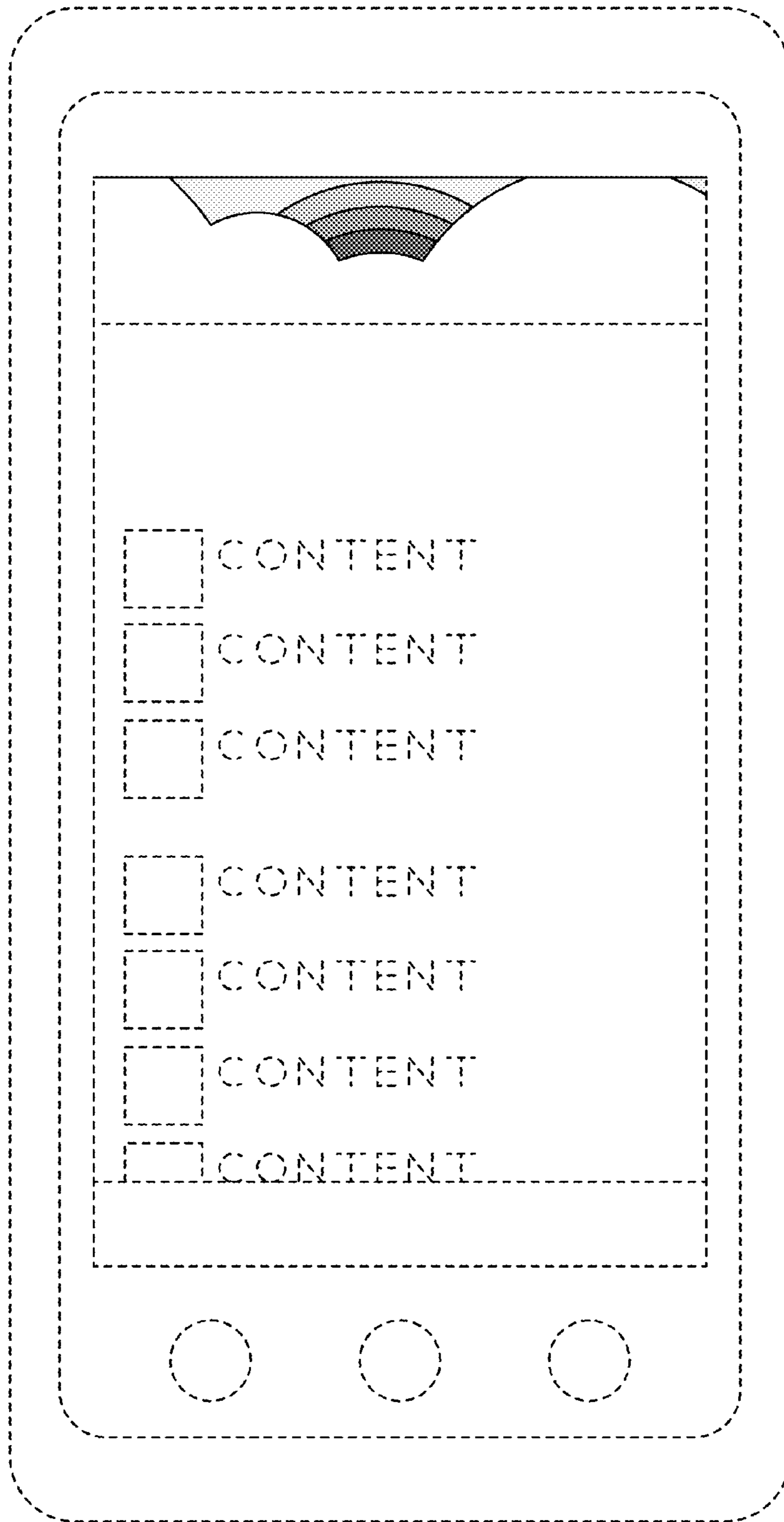

FIG. 9



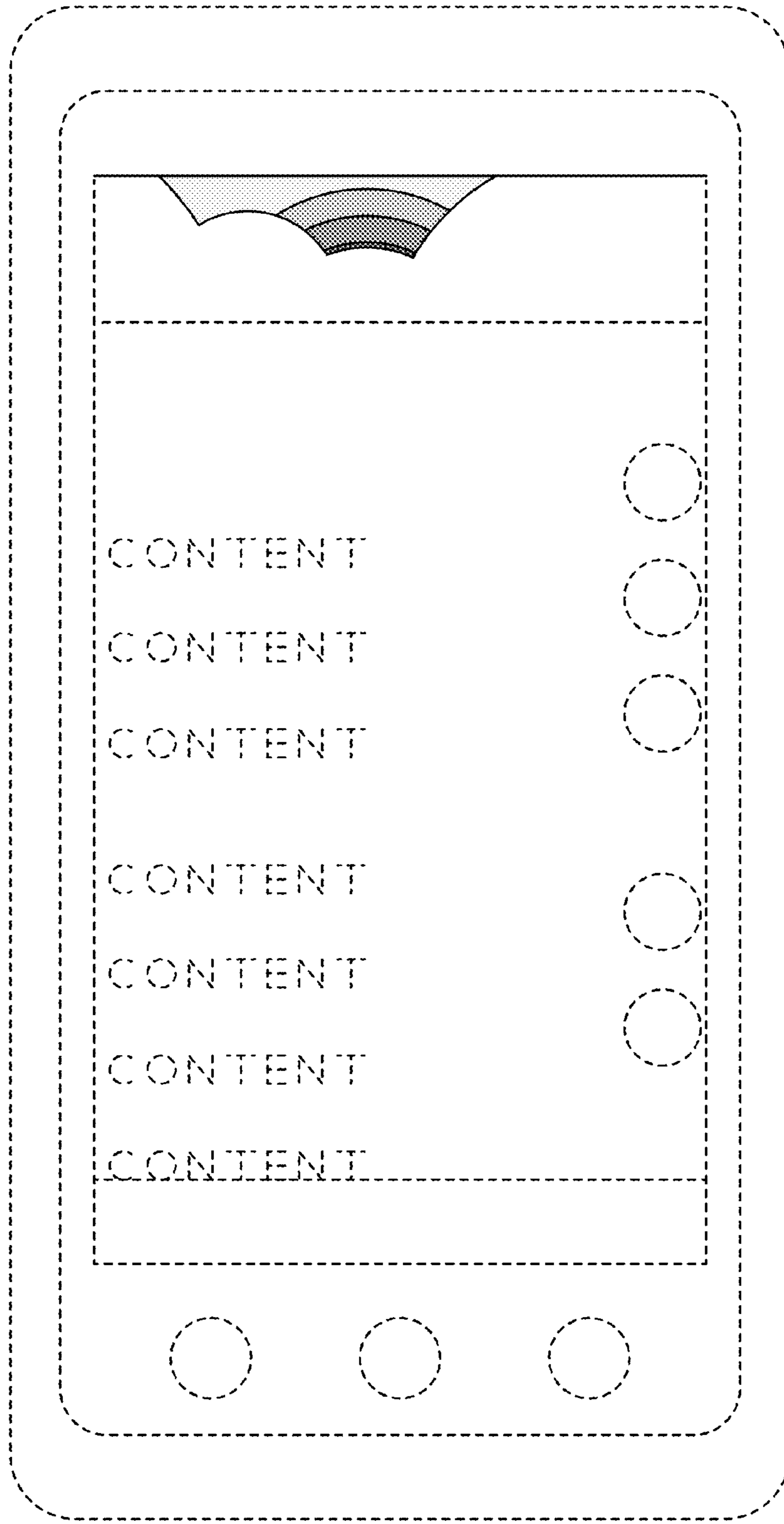

FIG. 11

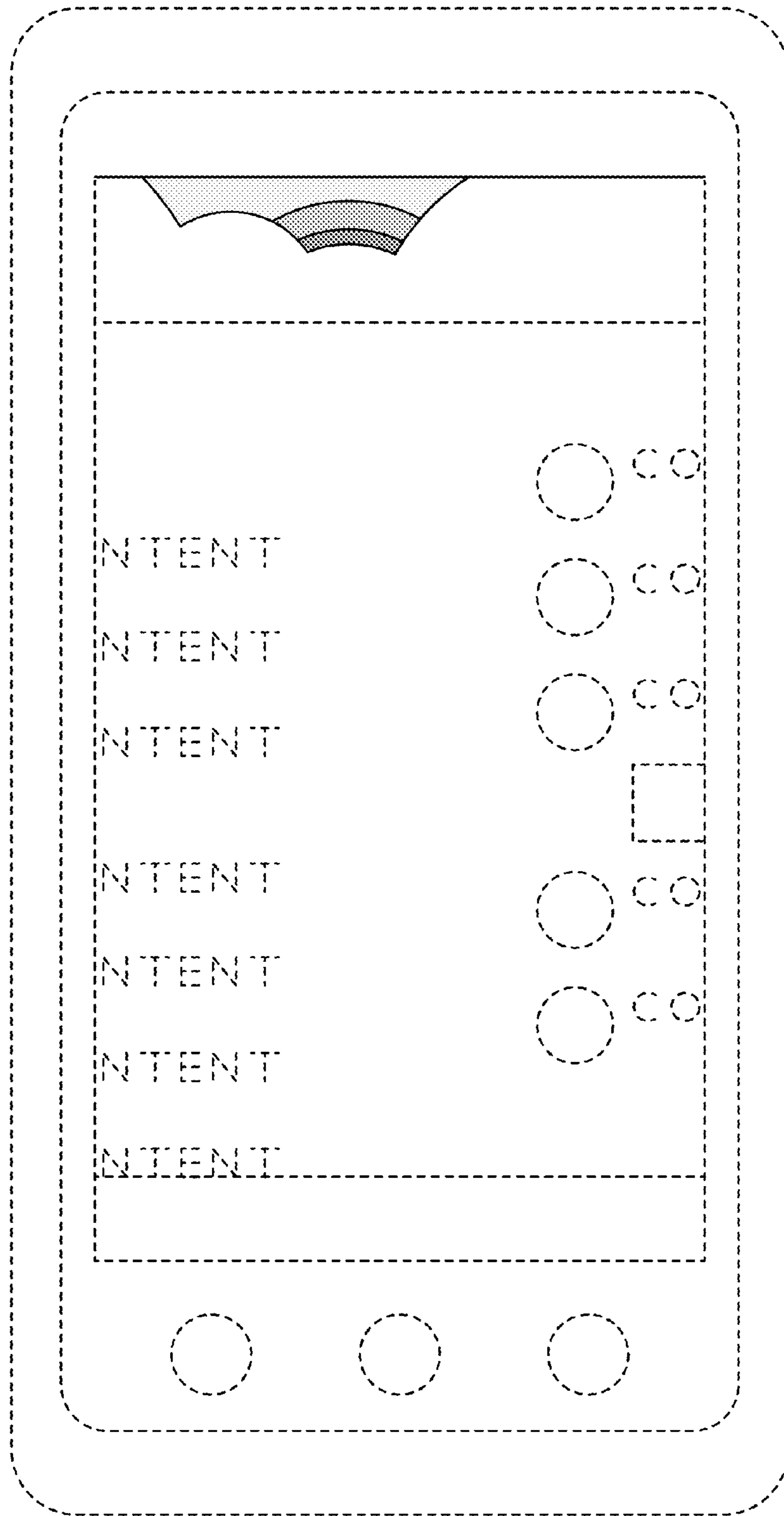

FIG. 12

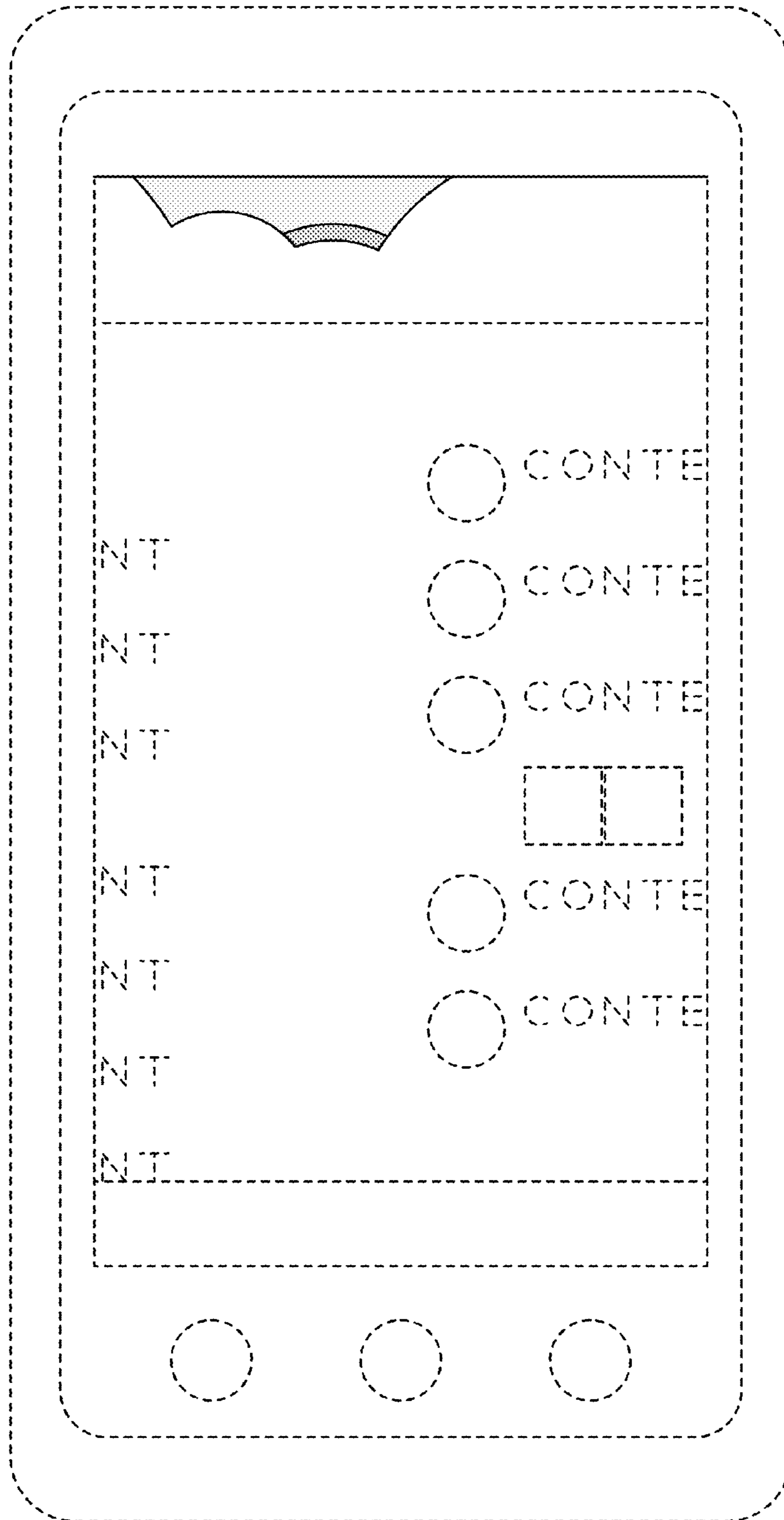

FIG. 13

