



US00D751009S

(12) **United States Design Patent**
Behmer et al.

(10) **Patent No.:** **US D751,009 S**
(45) **Date of Patent:** **** Mar. 8, 2016**

(54) **VEHICLE REAR LOWER BUMPER COVER INSERT**

(71) Applicant: **Ford Motor Company**, Dearborn, MI (US)

(72) Inventors: **Darrell Behmer**, Novi, MI (US); **Henry Bernardo**, Southfield, MI (US); **Damon Depeyster**, Northville, MI (US)

(73) Assignee: **Ford Motor Company**, Dearborn, MI (US)

(**) Term: **14 Years**

(21) Appl. No.: **29/508,876**

(22) Filed: **Nov. 12, 2014**

(51) **LOC (10) Cl.** **12-16**

(52) **U.S. Cl.**
USPC **D12/169**

(58) **Field of Classification Search**
USPC D12/86, 90, 91, 92, 163, 164, 169, 171, D12/196, 216; 180/68.4, 68.6; 293/102, 293/112, 113, 115, 117, 120; 296/180.1, 296/180.2

CPC B60R 19/02; B60R 19/18; B60R 19/24; B60R 19/56; B60R 2019/007; B62D 25/0845
See application file for complete search history.

(56) **References Cited**

U.S. PATENT DOCUMENTS

6,435,298	B1	*	8/2002	Mizuno	B62D 35/02
						180/346
D538,209	S	*	3/2007	Fujimaki	D12/169
D543,920	S	*	6/2007	Lai	D12/196
D545,732	S	*	7/2007	Truebsbach	D12/169
D610,503	S		2/2010	Bucher et al.		
D610,504	S		2/2010	Bucher et al.		
D614,093	S	*	4/2010	Ectors	D12/169

D623,994	S	*	9/2010	Miyazawa	D12/169
D640,617	S	*	6/2011	Furst	D12/169
D643,349	S	*	8/2011	Schell	D12/169
D643,789	S	*	8/2011	Bauer	D12/169
D671,047	S	*	11/2012	Davidson	D12/169
D671,050	S	*	11/2012	Davidson	D12/169
D671,051	S	*	11/2012	Davidson	D12/169
D695,164	S	*	12/2013	Futschik	D12/169

OTHER PUBLICATIONS

Jason Udy. Spied: Refreshed 2016 Ford Explorer Loses Some Camo. Oct. 11, 2014 [online], [retrieved on Nov. 3, 2011] Retrieved from the Internet <URL: http://wot.motortrend.com/1410_spied_refreshed_2016_ford_explorer_loses_some_camo.html>.
2016 Ford Explorer SUV Review. [retrieved on Nov. 3, 2011] Retrieved from the Internet <URL: <http://www.edmunds.com/ford/explorer/2016/>>.

* cited by examiner

Primary Examiner — Philip S Hyder

Assistant Examiner — Darlington Ly

(74) *Attorney, Agent, or Firm* — Damian Porcari

(57) **CLAIM**

The ornamental design for a vehicle rear lower bumper cover insert, as shown and described.

DESCRIPTION

FIG. 1 is a bottom left perspective view of a vehicle rear lower bumper cover insert;
FIG. 2 is a bottom right perspective view thereof;
FIG. 3 is a top rear perspective view thereof;
FIG. 4 is a front elevational view thereof;
FIG. 5 is a rear elevational view thereof;
FIG. 6 is a left side elevational view thereof;
FIG. 7 is a right side elevational view thereof;
FIG. 8 is a top plan view thereof; and,
FIG. 9 is a bottom plan view thereof.

1 Claim, 9 Drawing Sheets

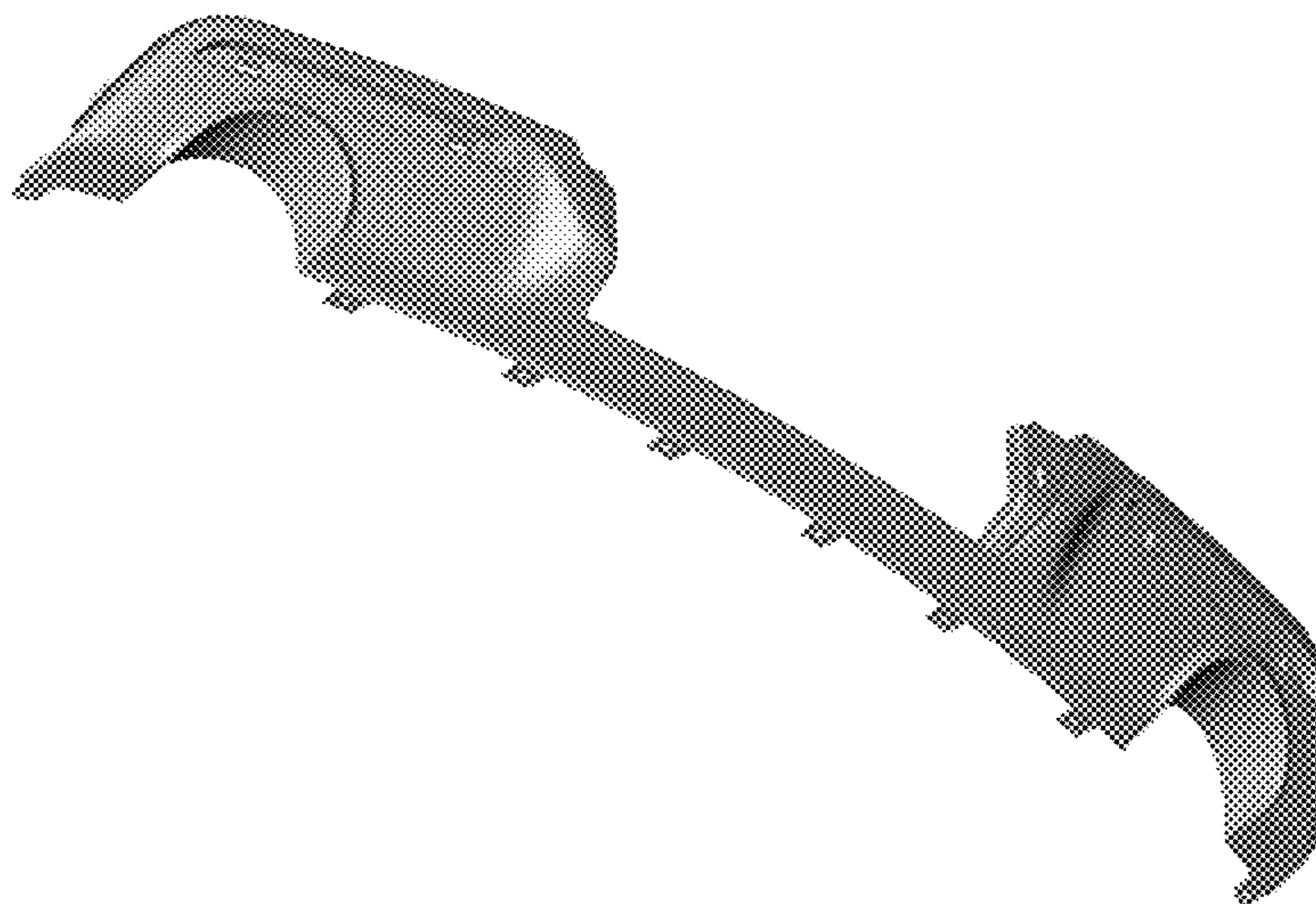

Figure 1

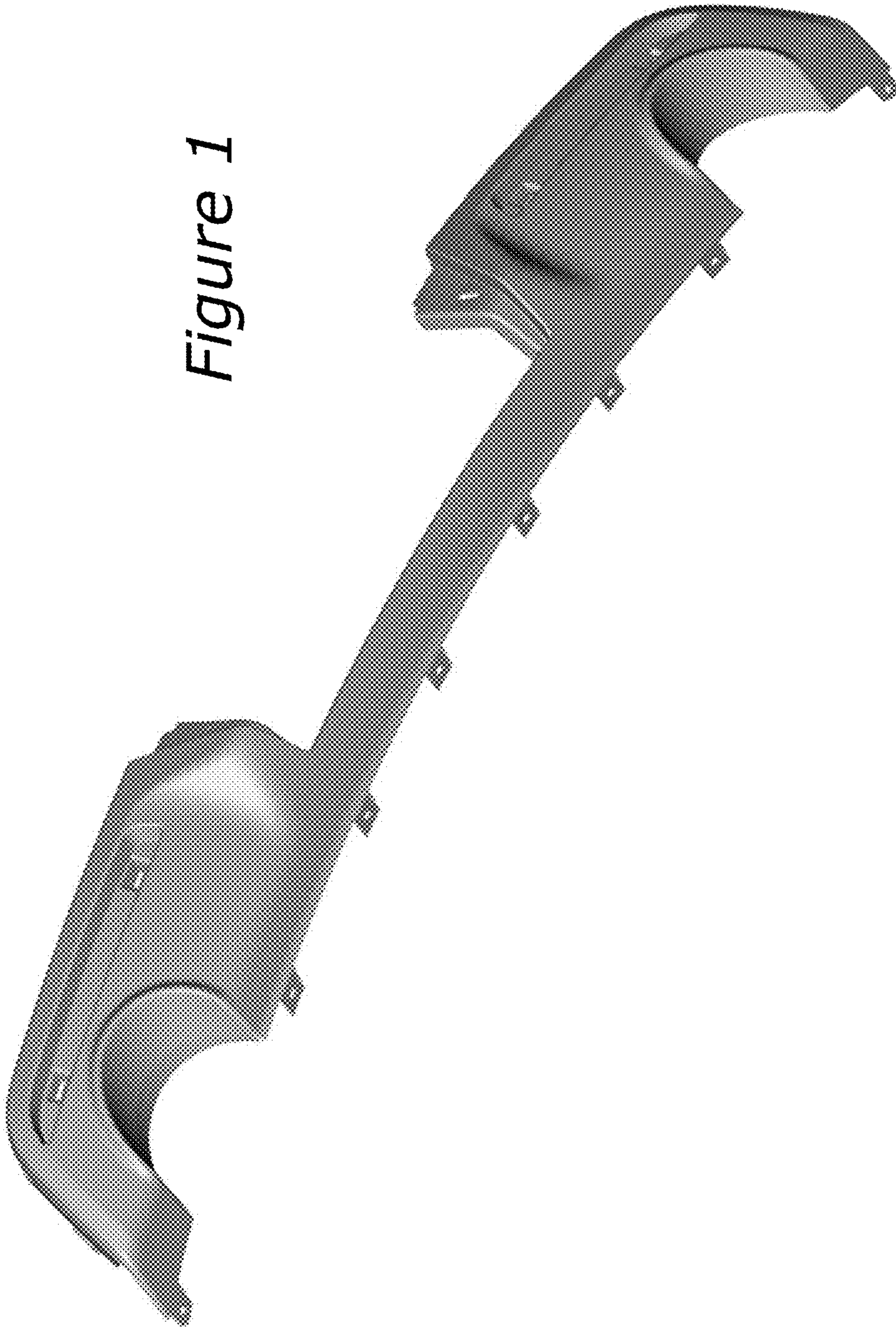
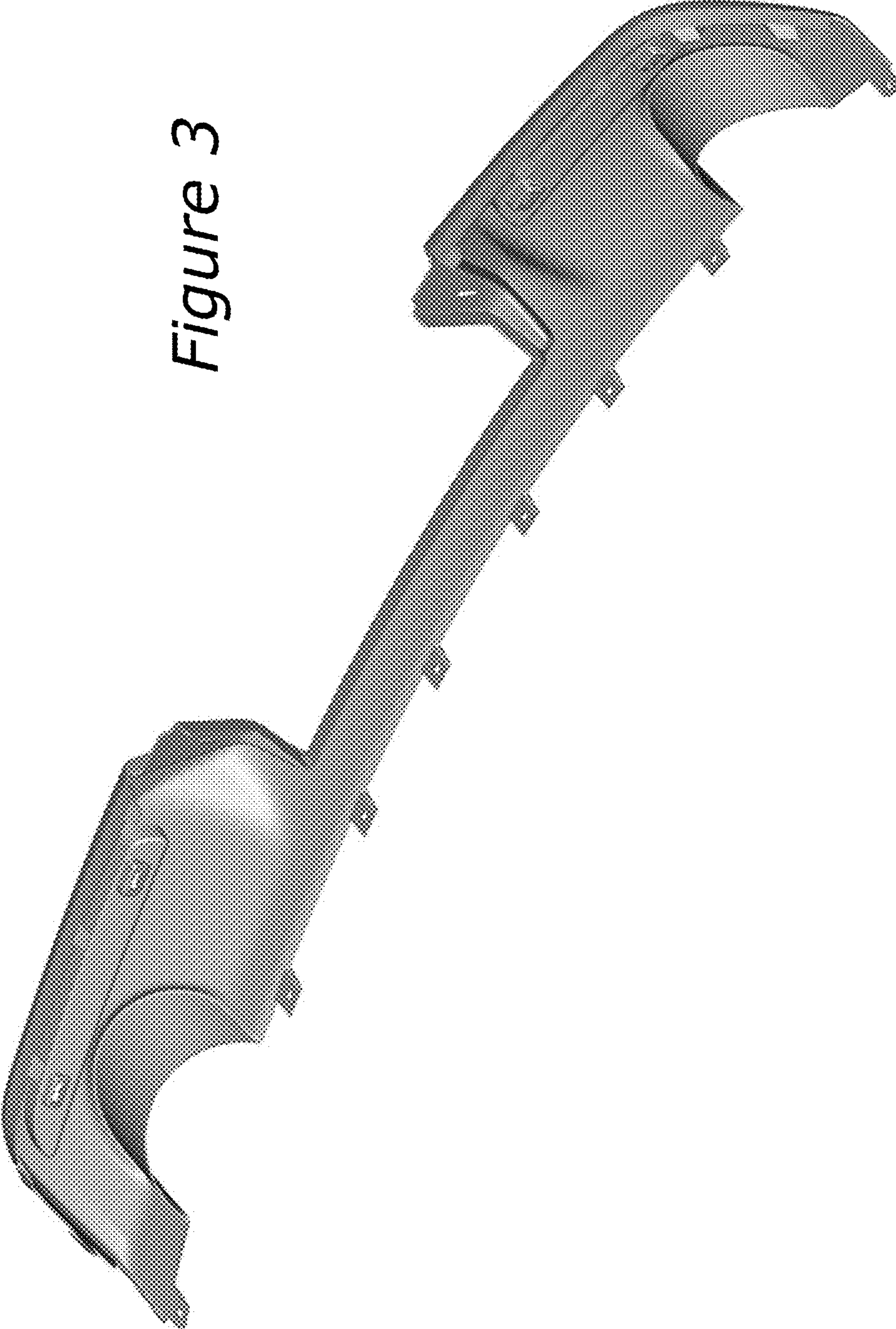



Figure 2

Figure 3



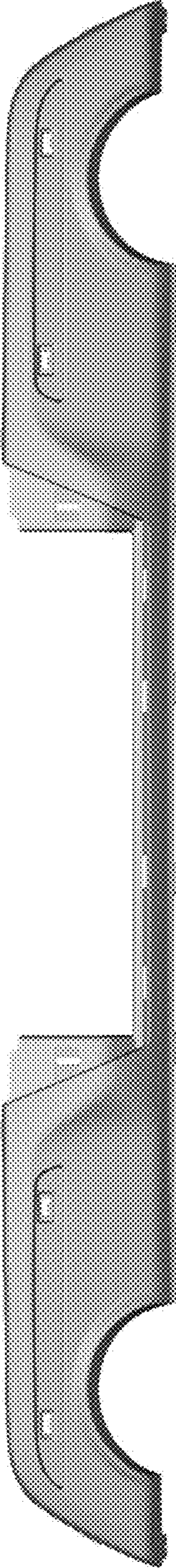

Figure 4

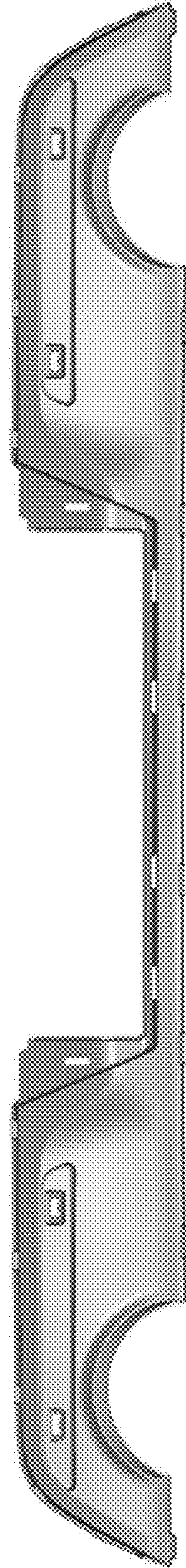

Figure 5

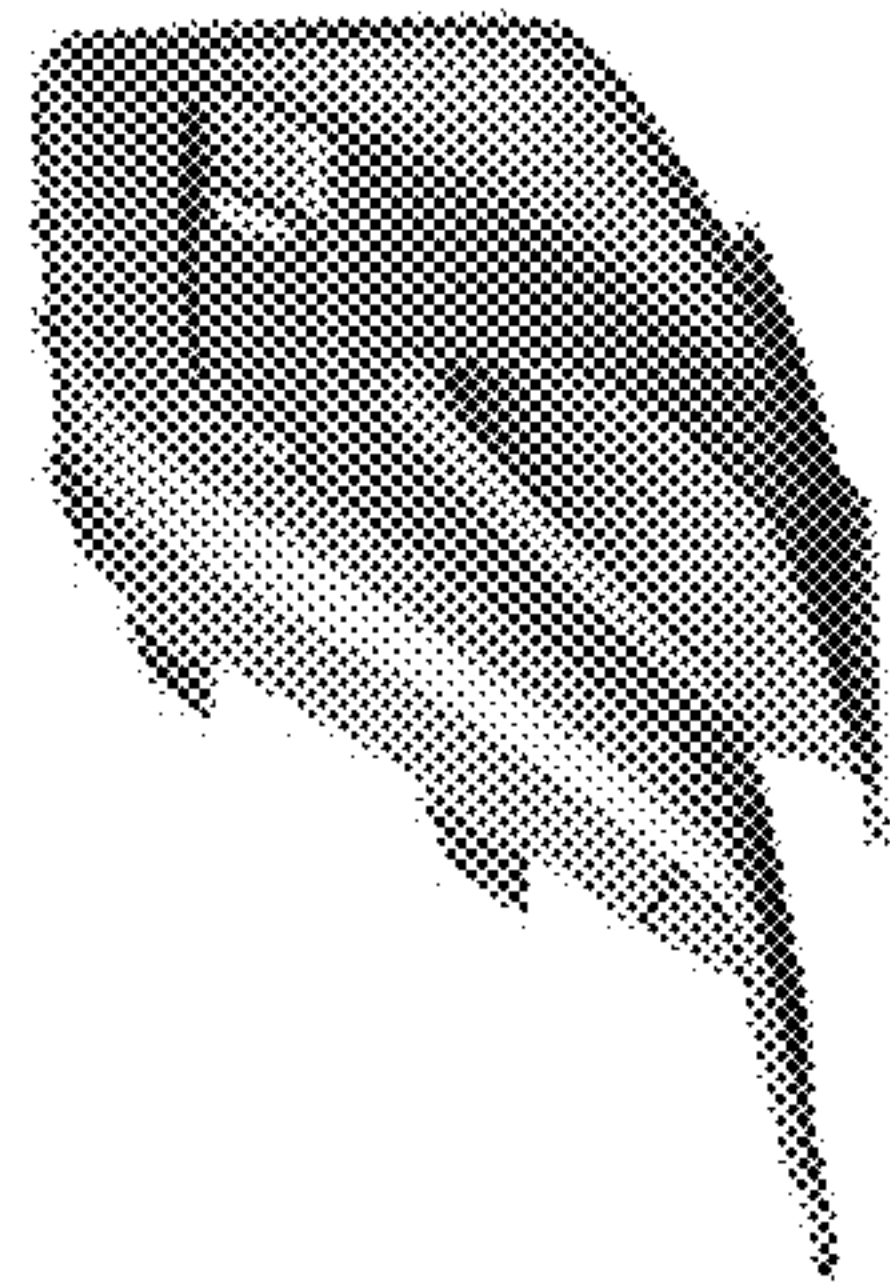

Figure 6

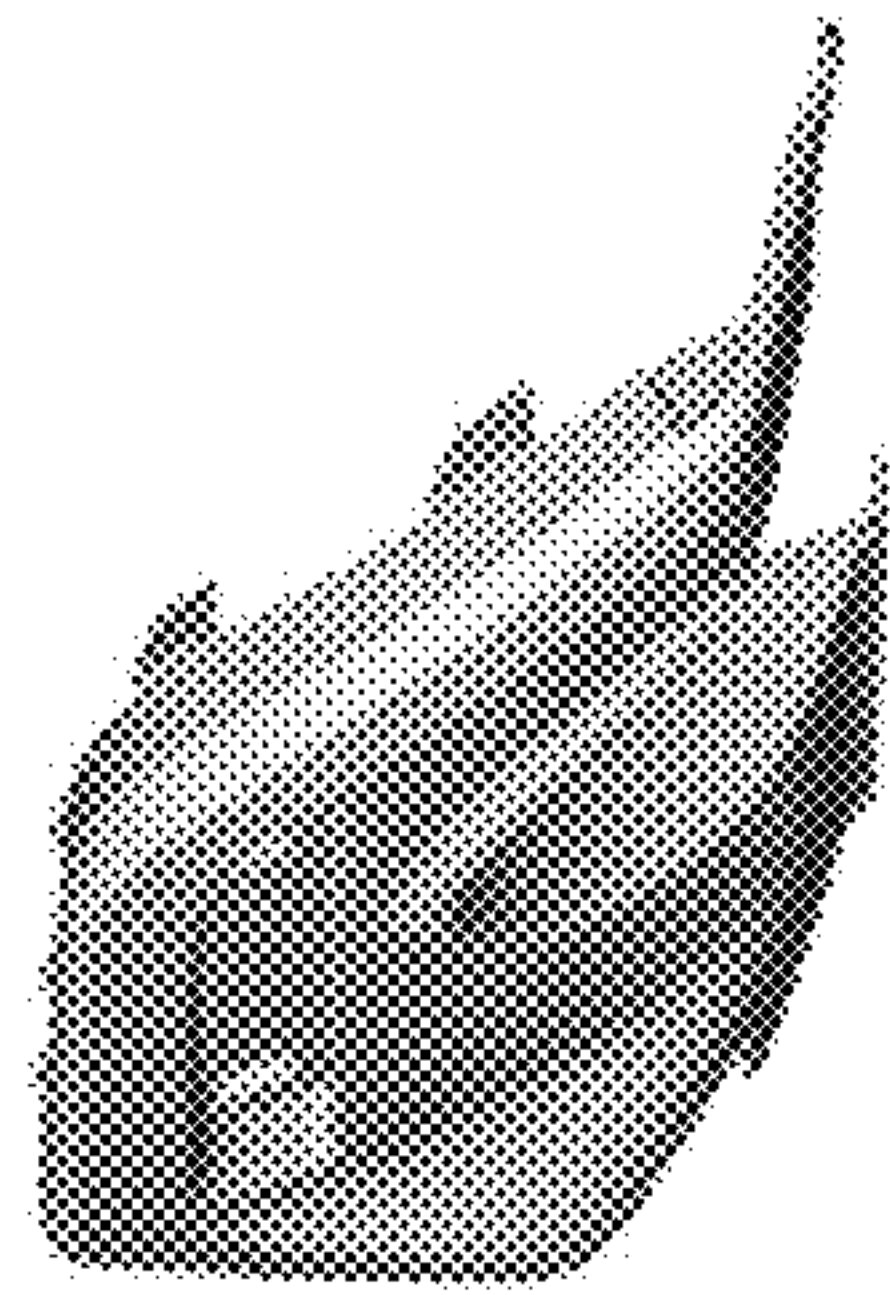

Figure 7

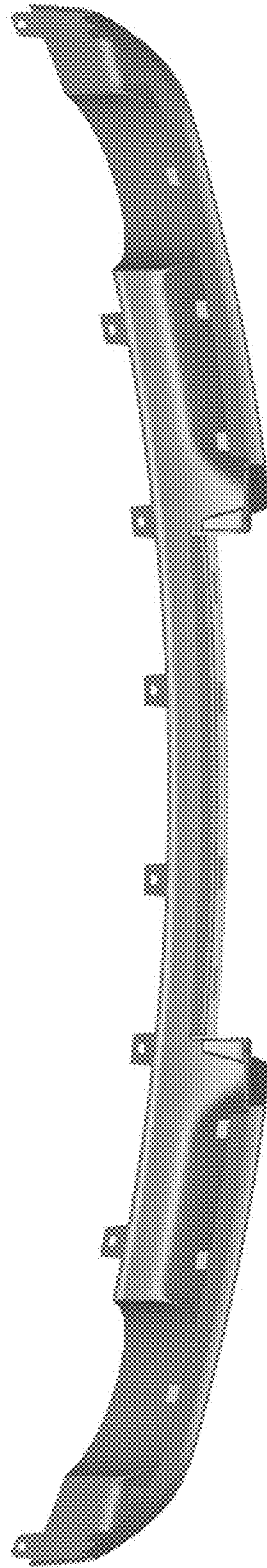

Figure 8

Figure 9

