



US00D750982S

(12) **United States Design Patent**
Gordon

(10) **Patent No.:** **US D750,982 S**
(45) **Date of Patent:** **** Mar. 8, 2016**

(54) **PRO TOUCH OFF GAUGE**

(71) Applicant: **Sean E. Gordon**, Tucson, AZ (US)

(72) Inventor: **Sean E. Gordon**, Tucson, AZ (US)

(**) Term: **14 Years**

(21) Appl. No.: **29/509,451**

(22) Filed: **Nov. 18, 2014**

(51) **LOC (10) Cl.** **10-04**

(52) **U.S. Cl.**
USPC **D10/65**

(58) **Field of Classification Search**
USPC D10/65
CPC B23Q 17/22; B23Q 17/2208; B23Q 17/2216; B23Q 17/2225; B23Q 17/2233; B23Q 17/2241; B23Q 17/225; B23Q 17/2258; B23Q 17/2266; B23Q 17/2275; B23Q 17/2283; B23Q 17/2291; B23Q 17/24; B23Q 17/2404; B25H 7/00; B25H 7/005
See application file for complete search history.

(56) **References Cited**

U.S. PATENT DOCUMENTS

3,624,719	A *	11/1971	Romi	B23Q 17/22 33/628
3,838,521	A *	10/1974	Peterson	B23C 3/055 33/201
4,065,855	A *	1/1978	Coe	G01B 5/00 33/520
6,499,221	B1 *	12/2002	Kuhn	A61C 5/025 33/514

* cited by examiner

Primary Examiner — Antoine D Davis

(74) *Attorney, Agent, or Firm* — Lyman H. Moulton, III

(57) **CLAIM**

The ornamental design for a pro touch off gauge, as shown and described.

DESCRIPTION

FIG. 1 is a front right perspective view of a pro touch off gauge showing my new design;
FIG. 2 is a front elevational view thereof;
FIG. 3 is a right elevational view thereof;
FIG. 4 is a back elevational view thereof;
FIG. 5 is a left elevational view thereof;
FIG. 6 is a top elevational view thereof;
FIG. 7 is a bottom elevational view thereof;
FIG. 8 is a front right perspective view of a modified embodiment of the design shown in FIG. 1;
FIG. 9 is a front elevational view of the modified embodiment of the design shown in FIG. 2;
FIG. 10 is a right elevational view of the modified embodiment of the design shown in FIG. 3;
FIG. 11 is a back elevational view of the modified embodiment of the design shown in FIG. 4;
FIG. 12 is a left elevational view of the modified embodiment of the design shown in FIG. 5;
FIG. 13 is a top elevational view of the modified embodiment of the design shown in FIG. 6; and,
FIG. 14 is a bottom elevational view of the modified embodiment of the design shown in FIG. 7.

1 Claim, 14 Drawing Sheets

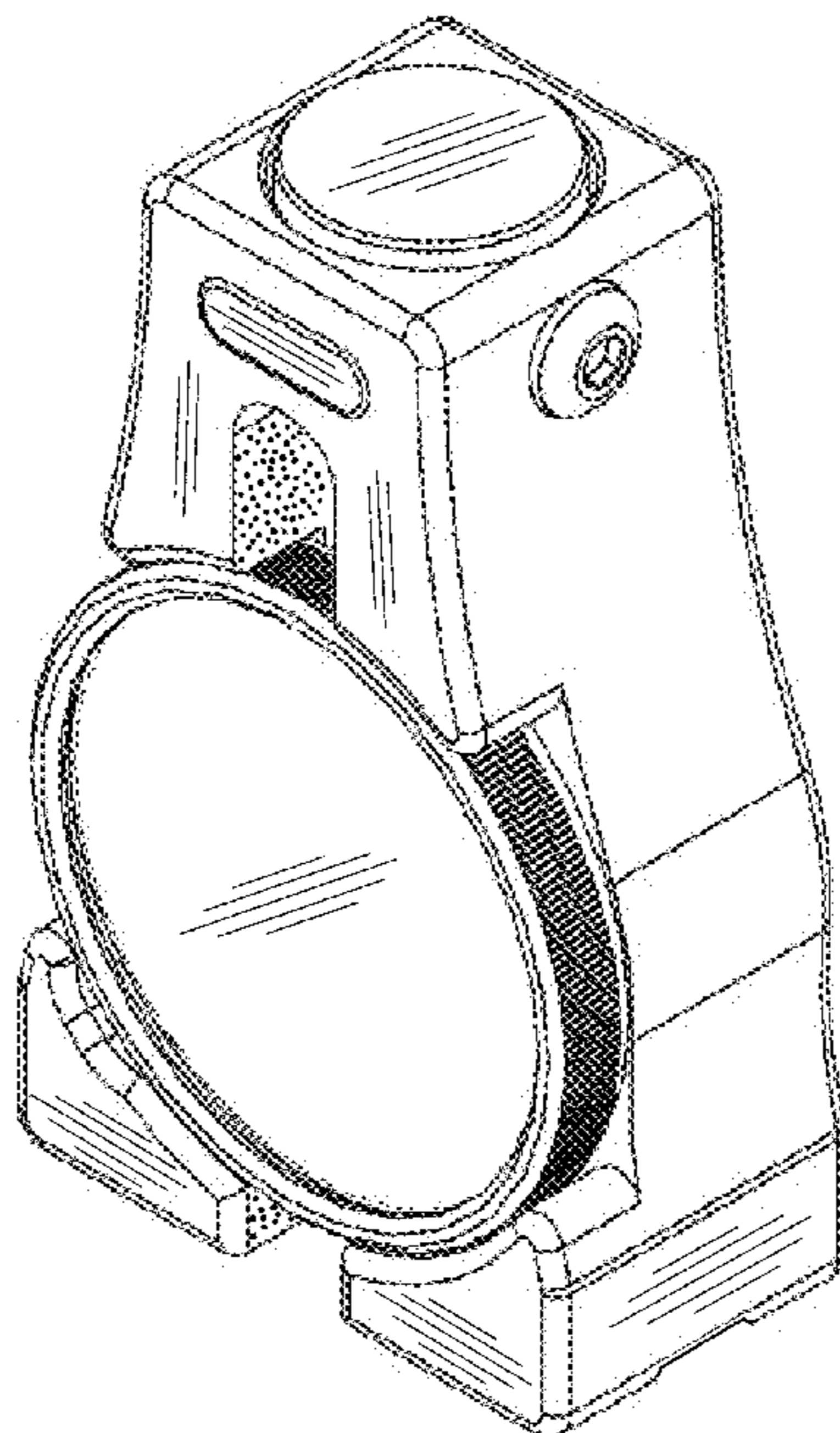

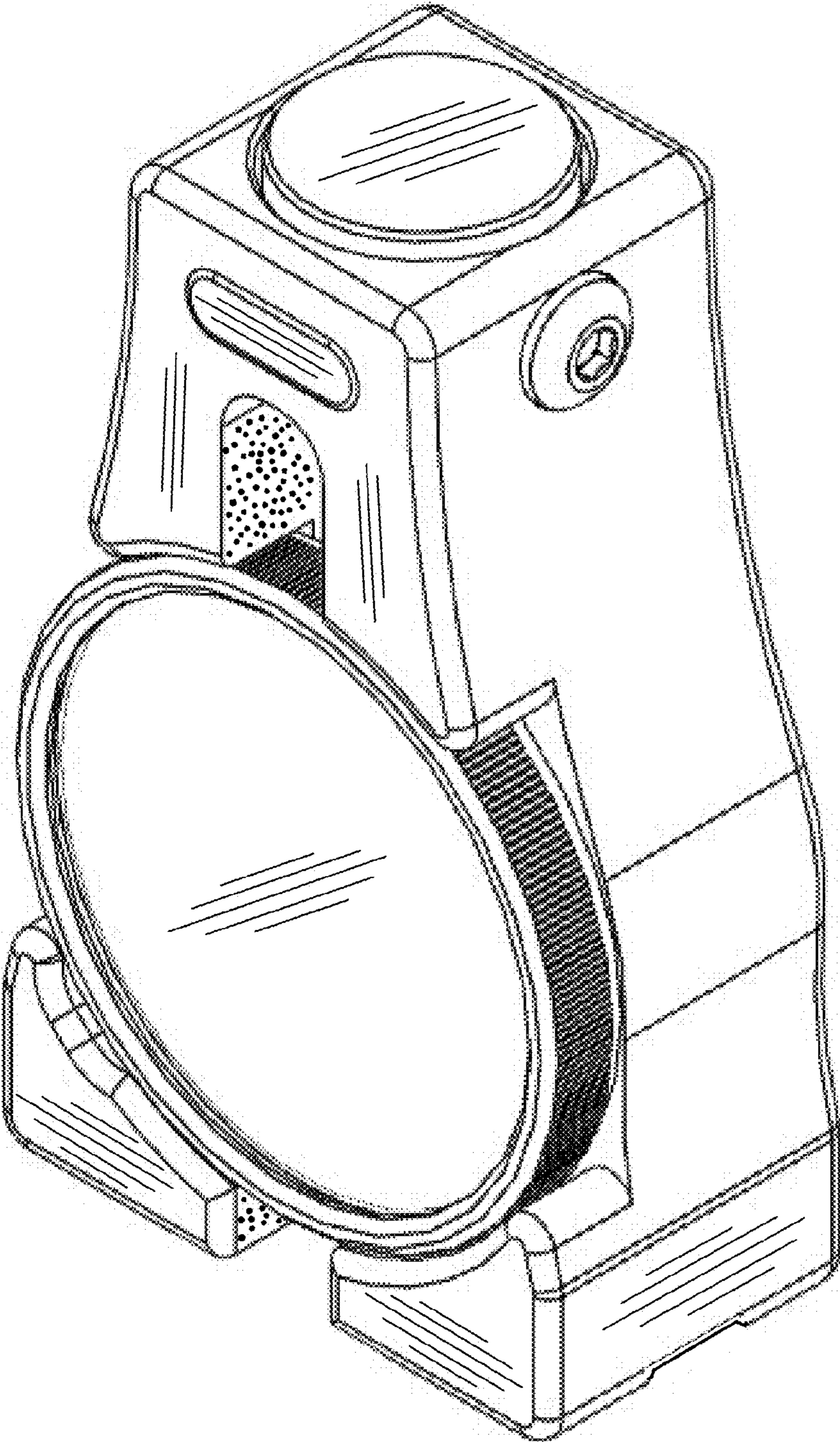

FIG. 1

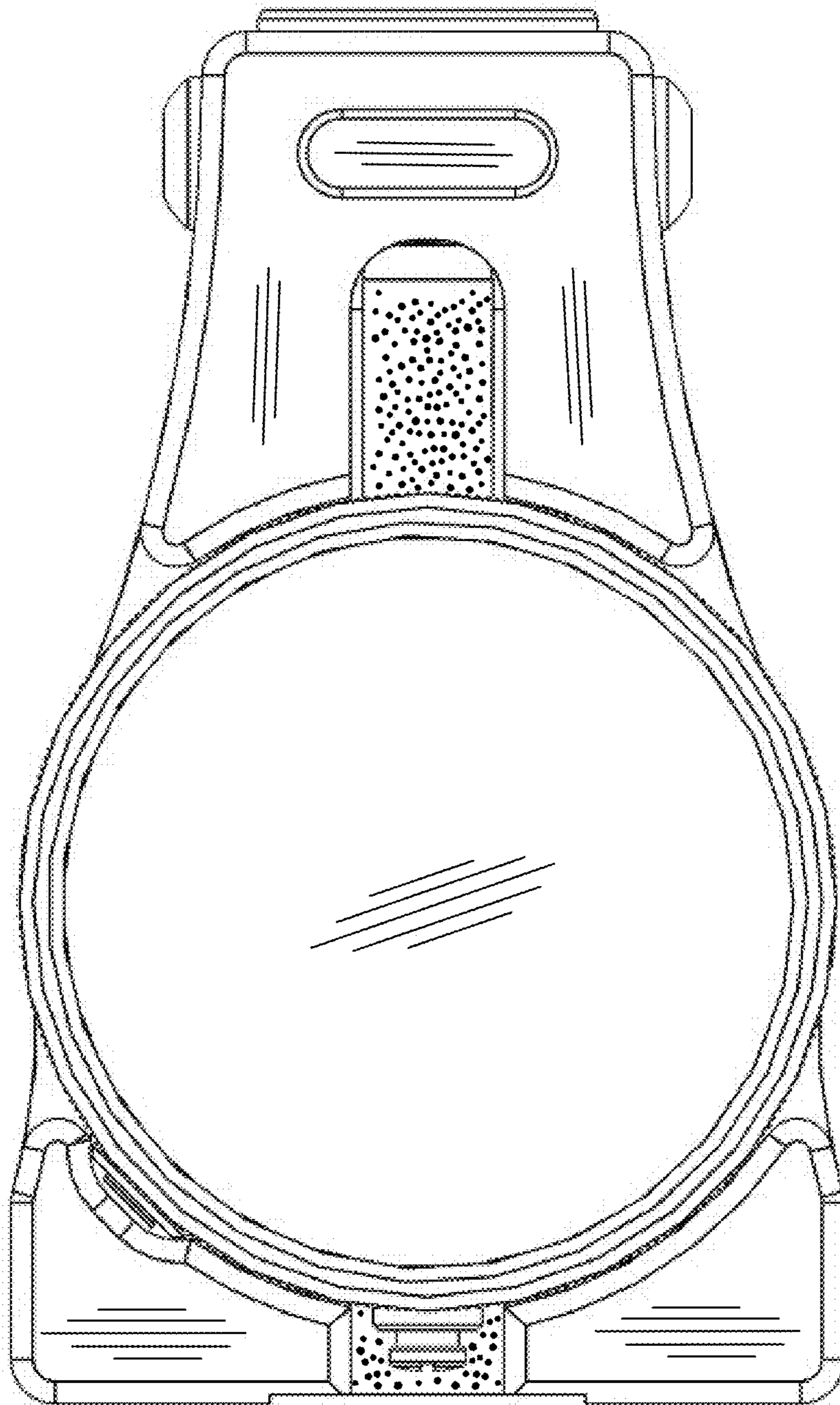

FIG. 2

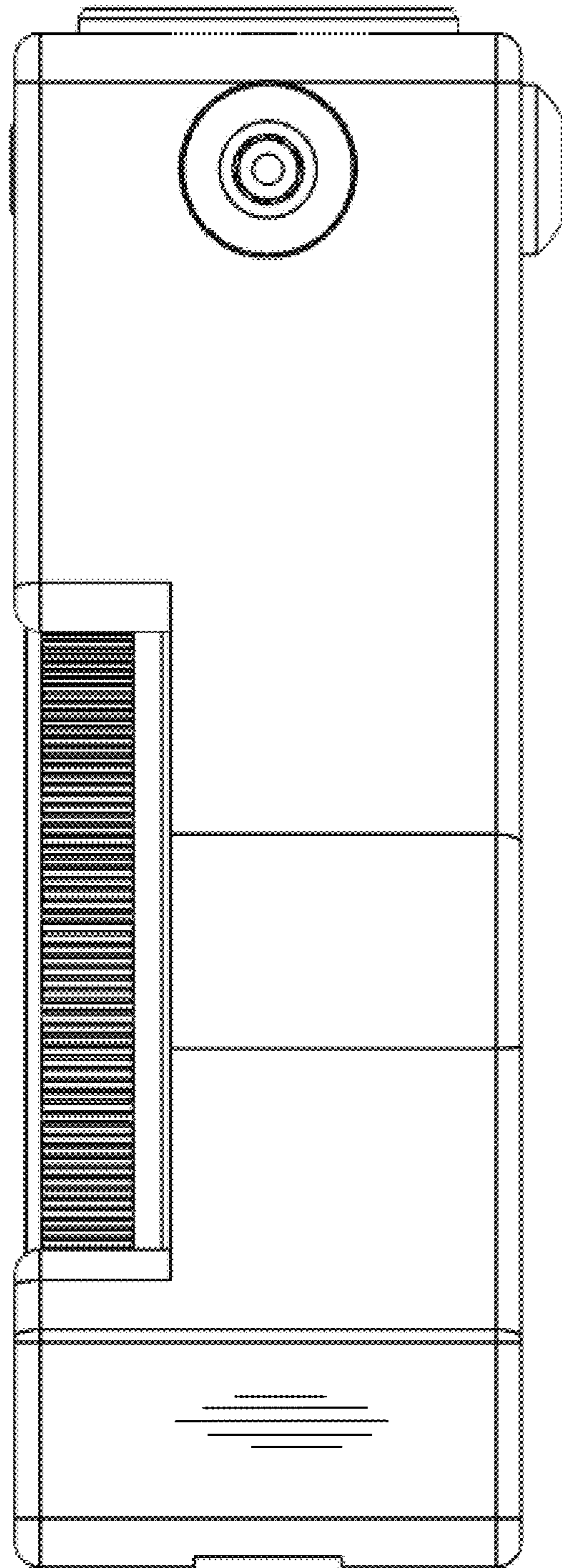

FIG. 3

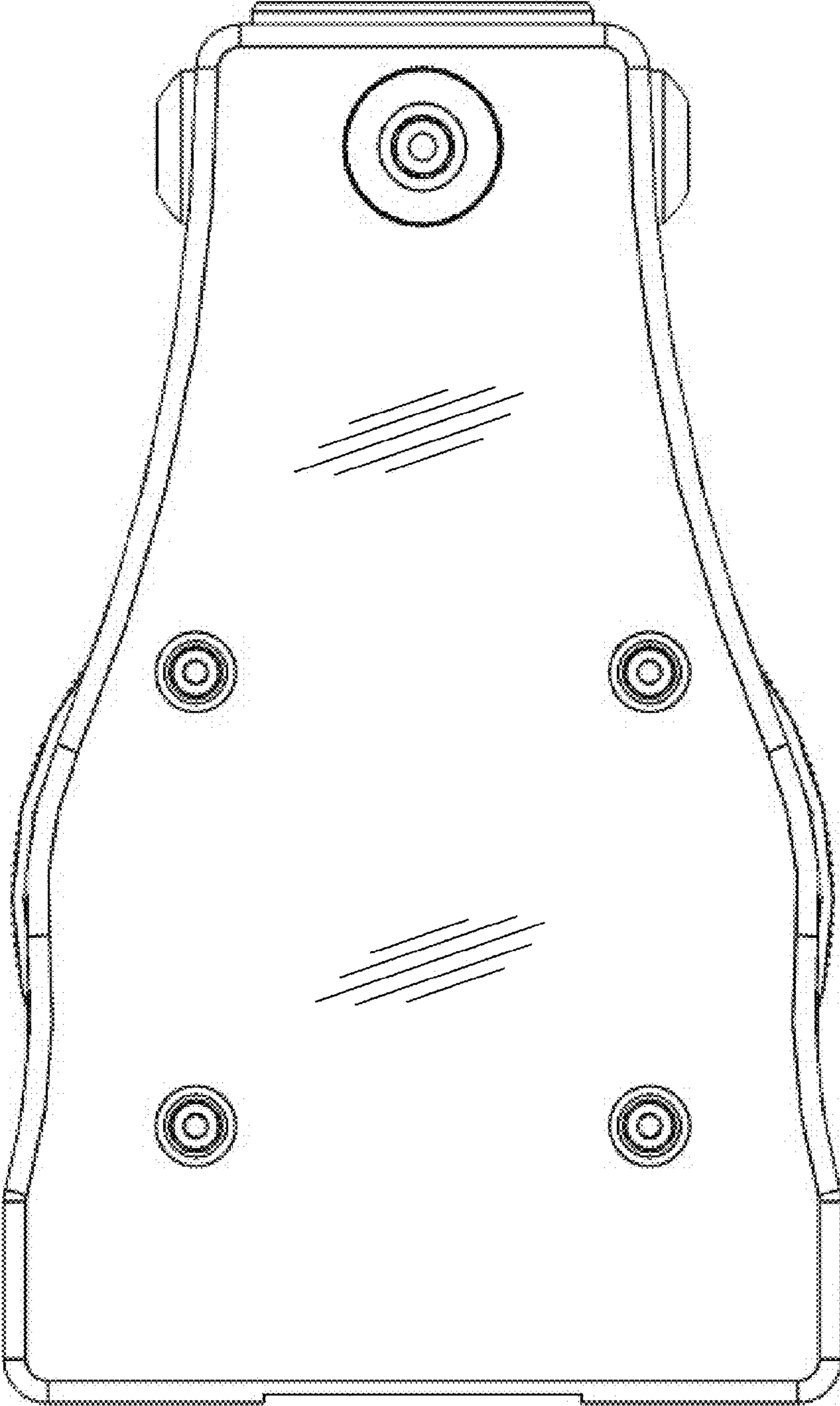

FIG. 4

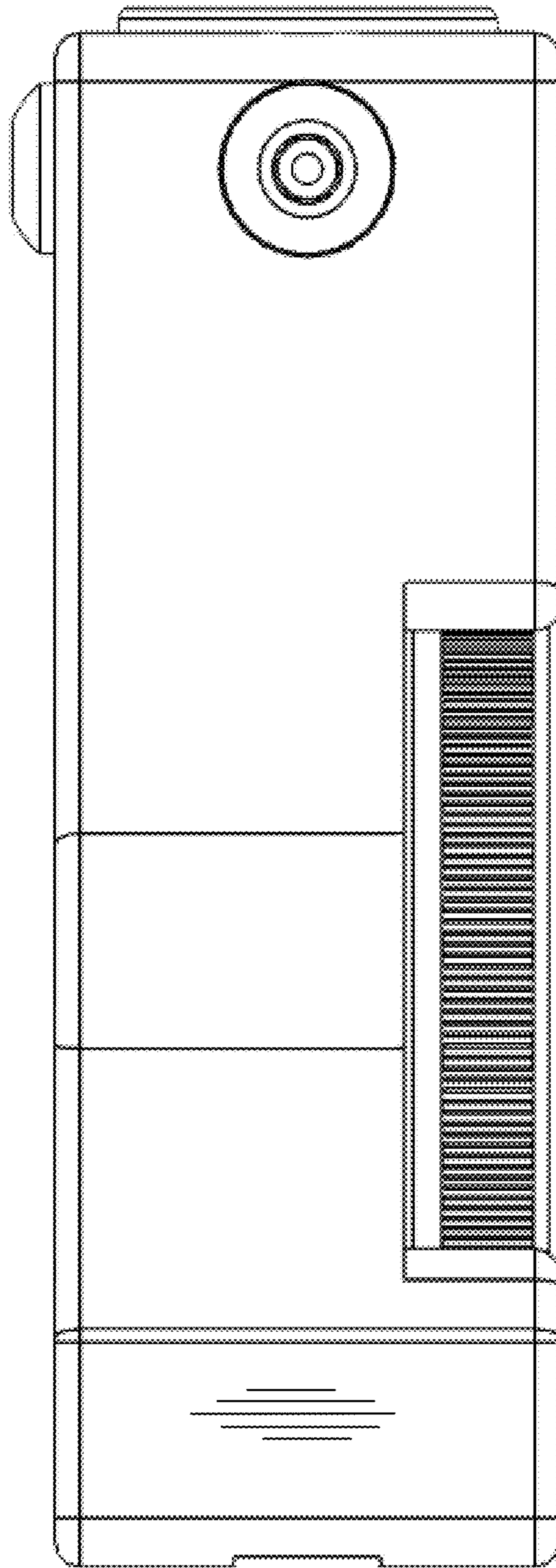

FIG. 5

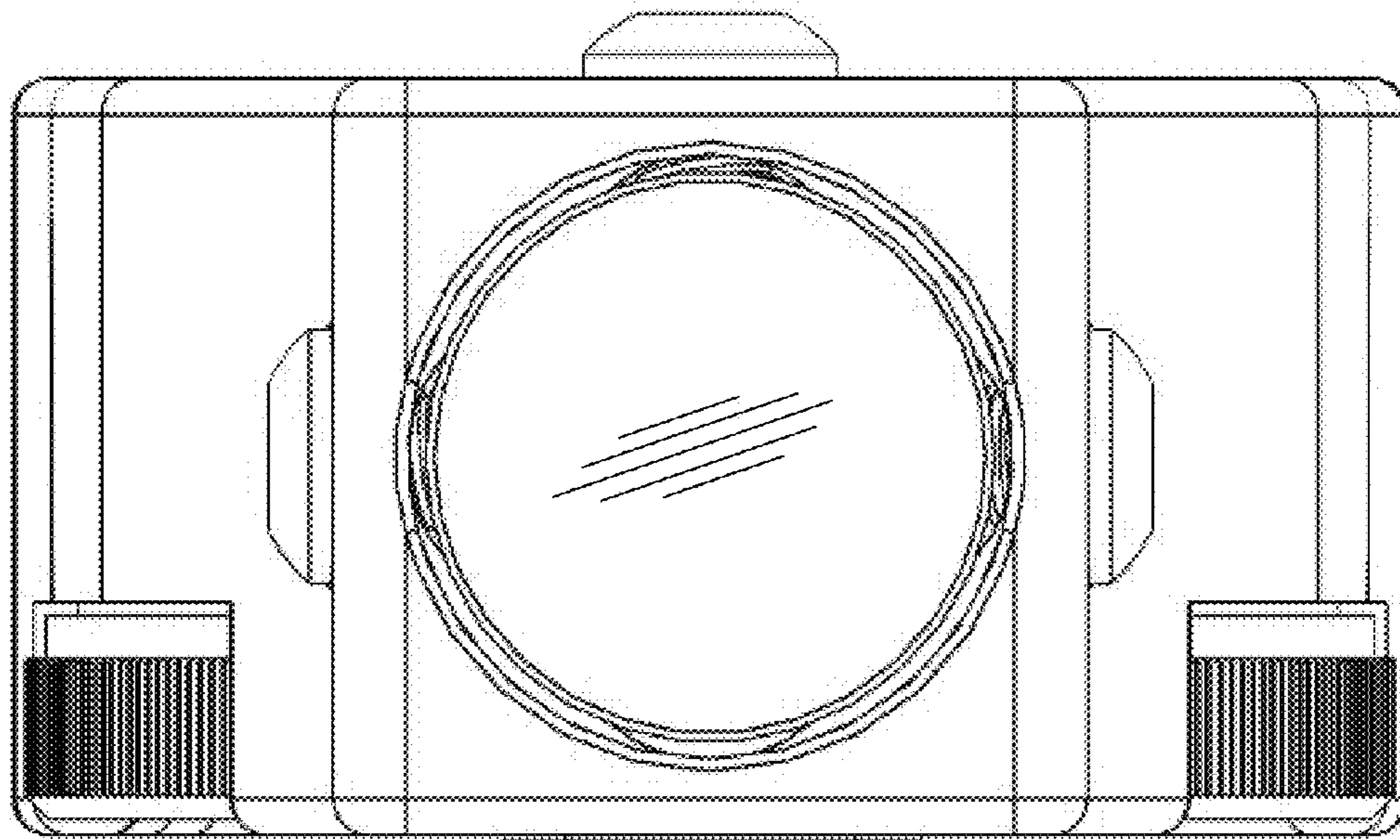

FIG. 6

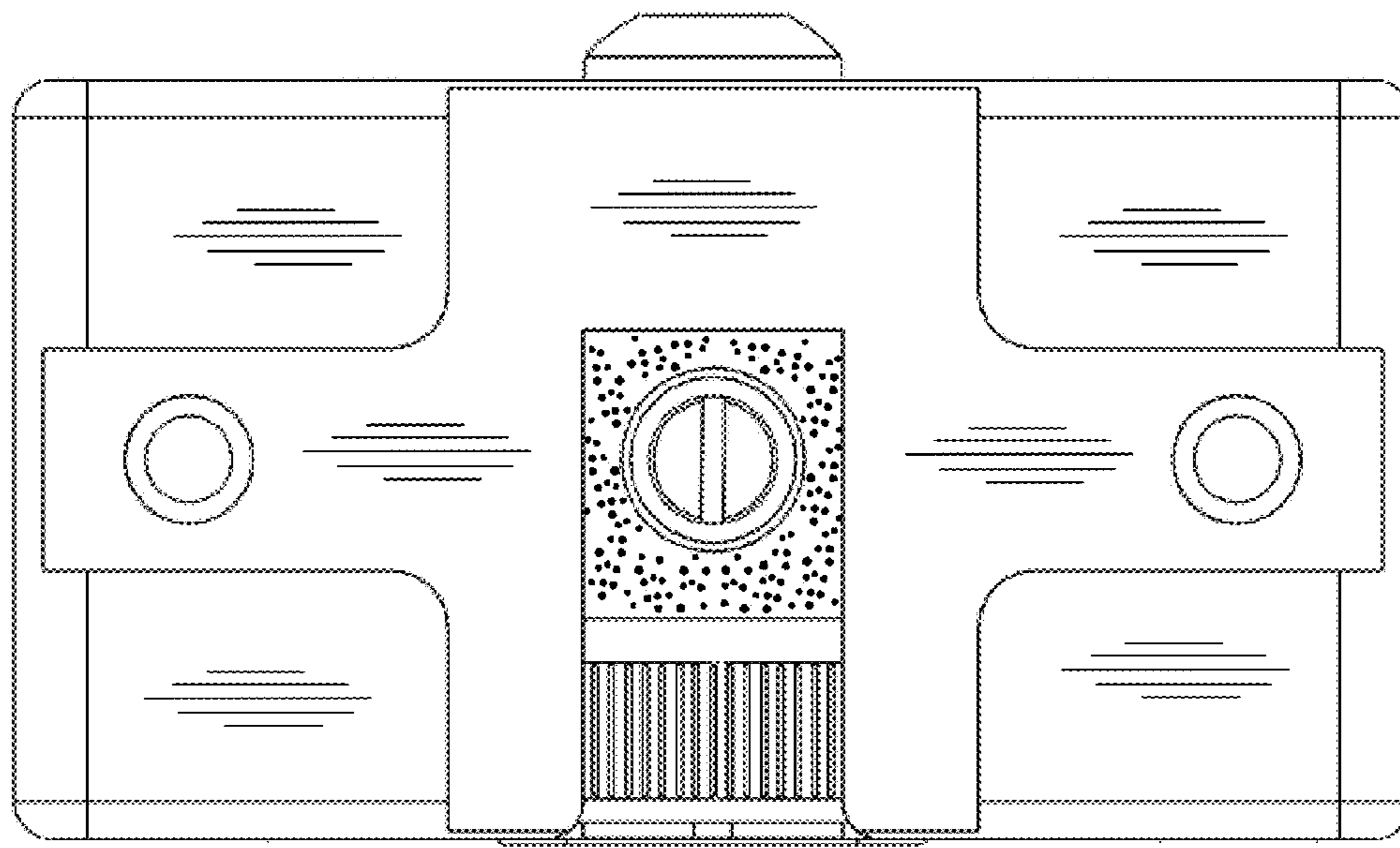

FIG. 7

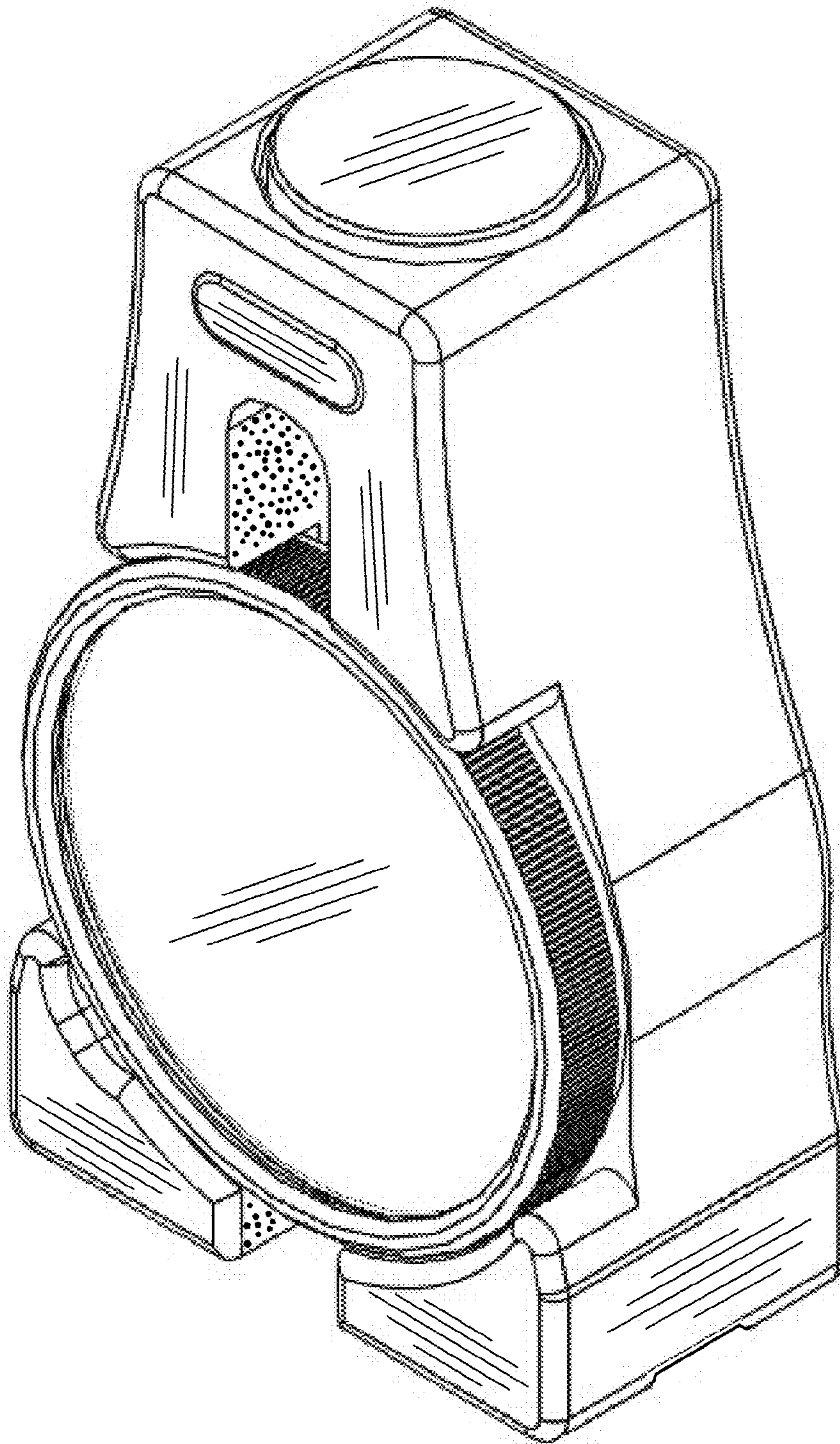

FIG. 8

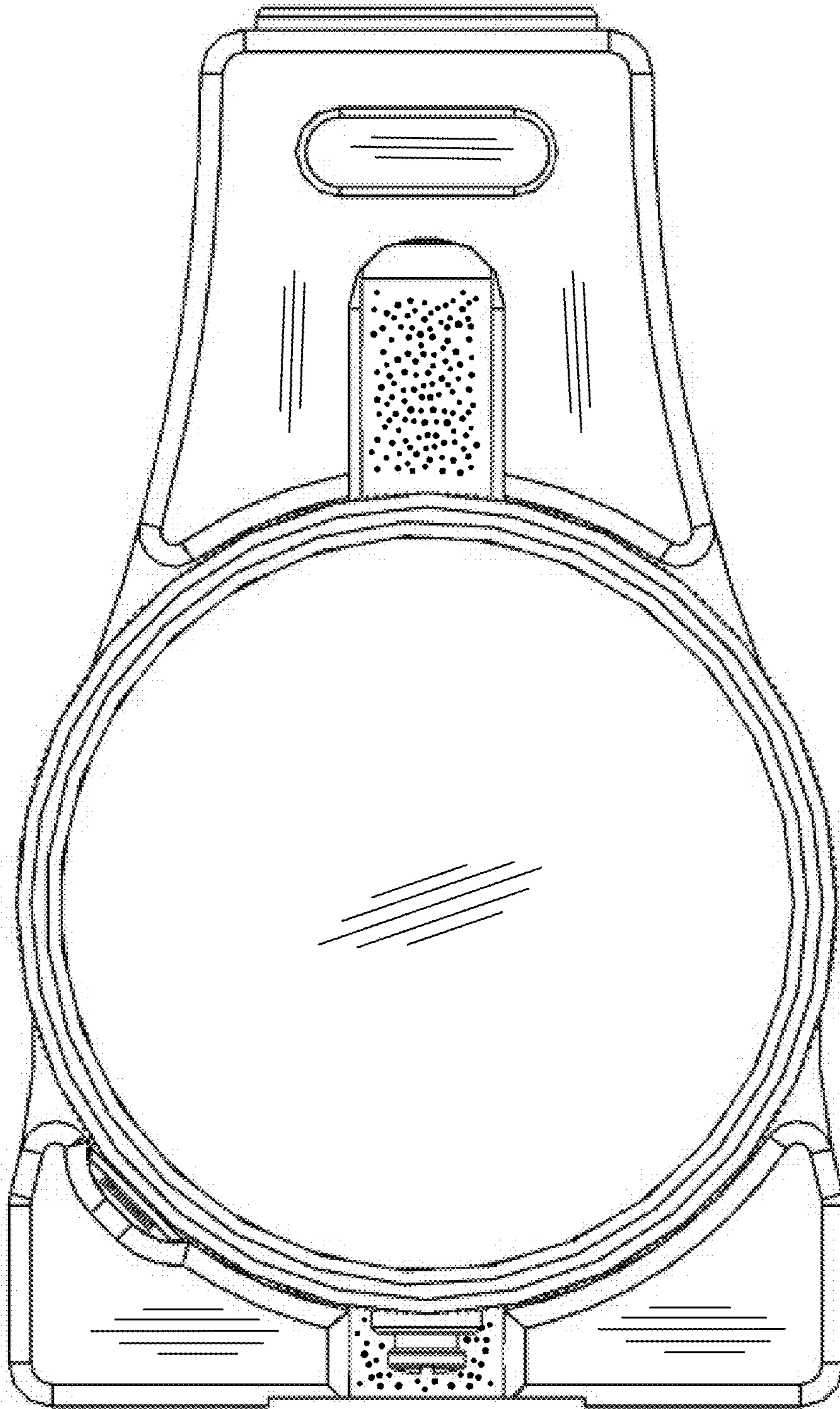

FIG. 9

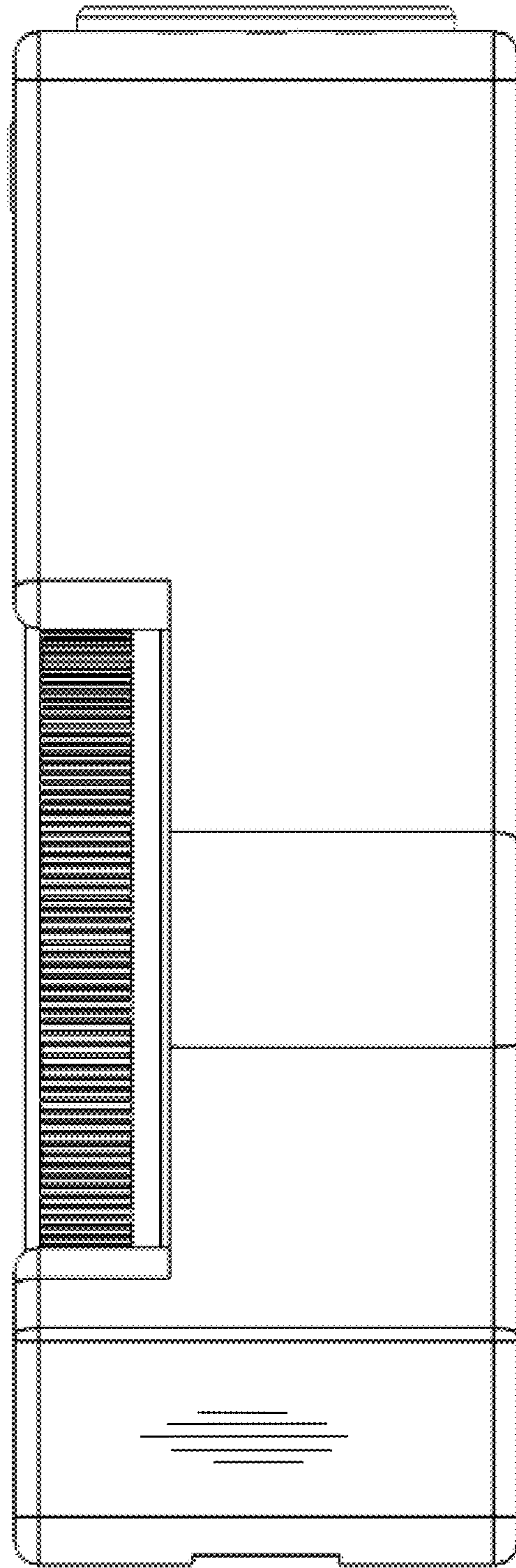

FIG. 10

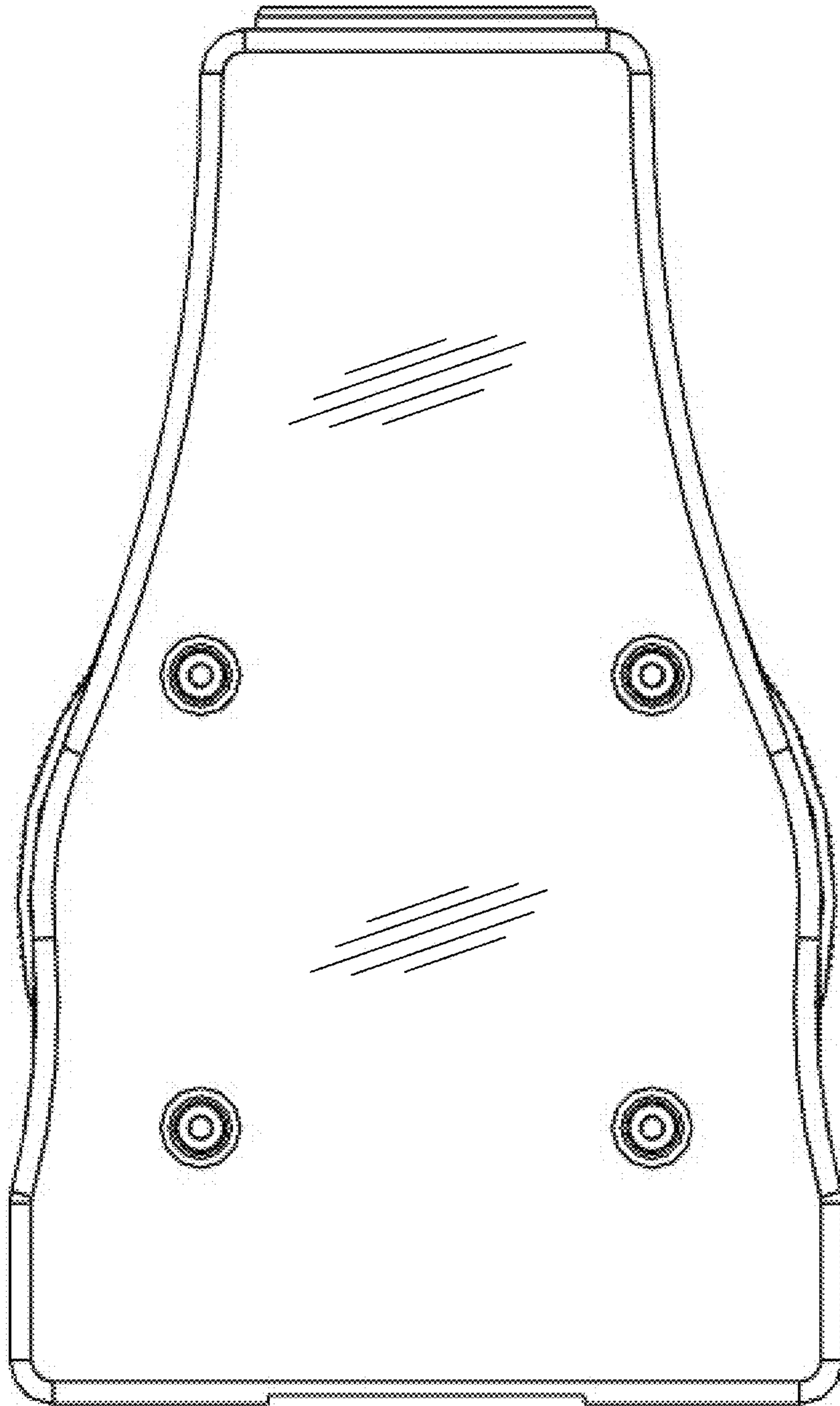

FIG. 11

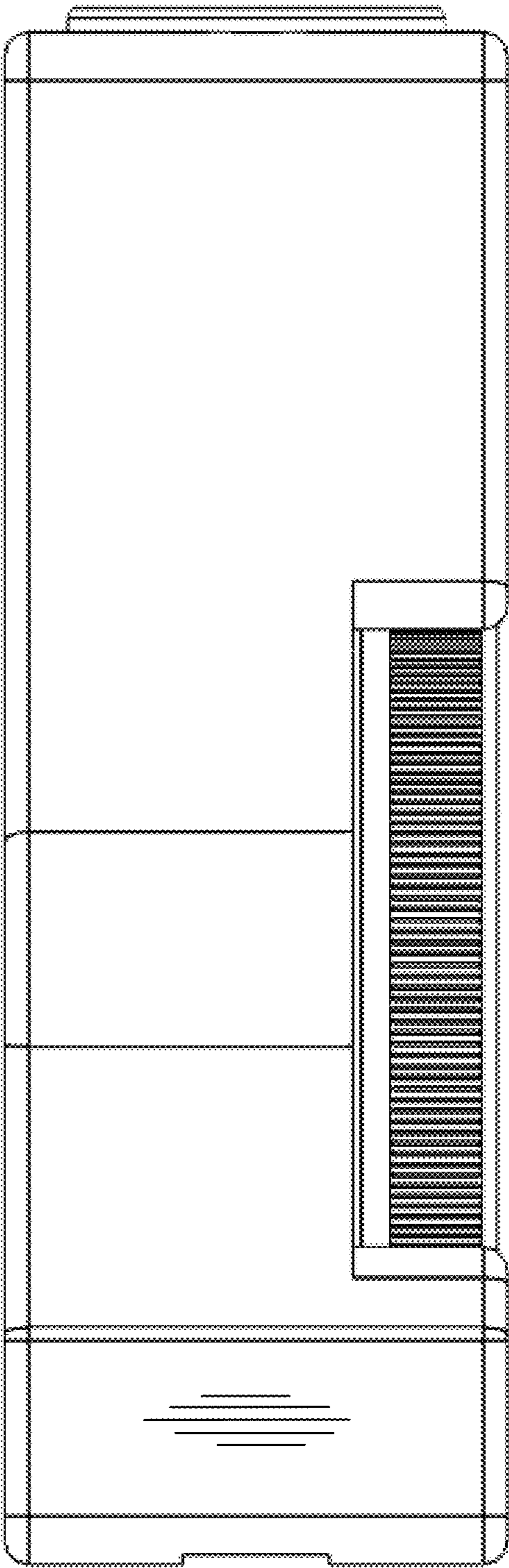

FIG. 12

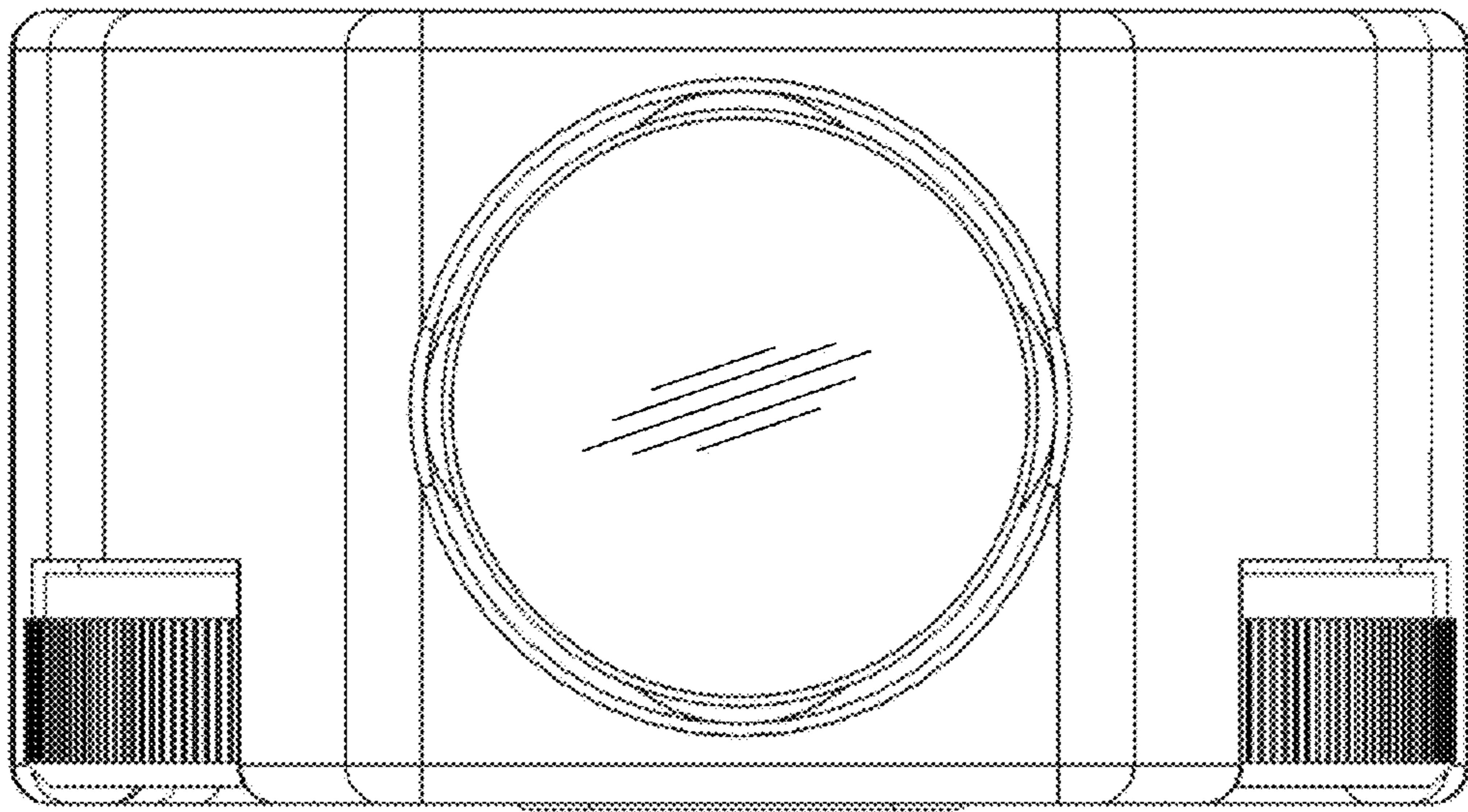

FIG. 13

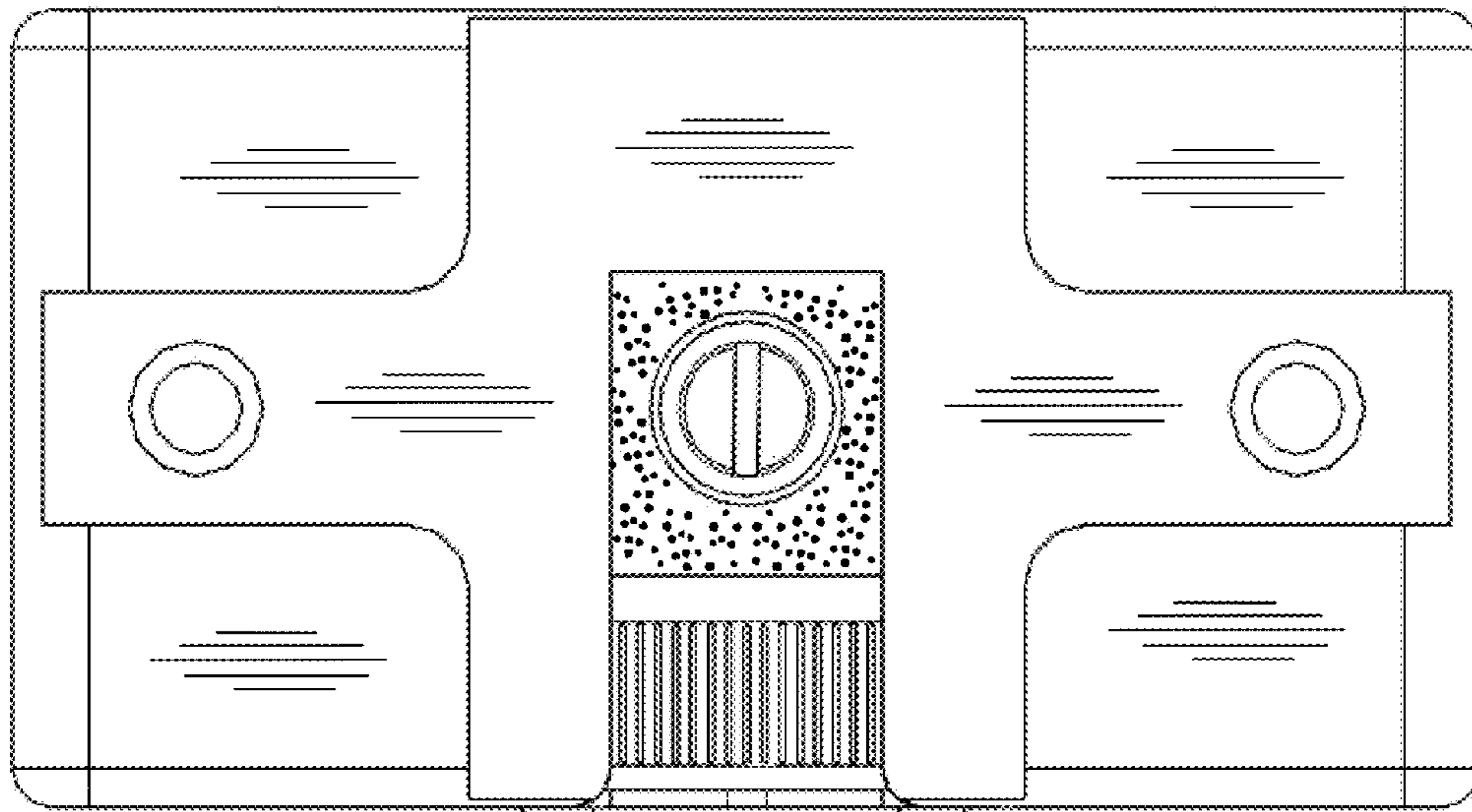

FIG. 14