



US00D750914S

(12) **United States Design Patent**
Melrose

(10) **Patent No.:** **US D750,914 S**
(45) **Date of Patent:** **** Mar. 8, 2016**

(54) **CHAIR**

(56) **References Cited**

(71) Applicant: **Walter Melrose**, Toronto (CA)

(72) Inventor: **Walter Melrose**, Toronto (CA)

(**) Term: **14 Years**

(21) Appl. No.: **29/514,337**

(22) Filed: **Jan. 12, 2015**

(51) **LOC (10) Cl.** **06-01**

(52) **U.S. Cl.**
USPC **D6/371**

(58) **Field of Classification Search**
USPC D6/334-336, 348, 371, 373, 374, 716,
D6/716.1, 716.4
CPC A47C 4/02; A47C 4/03; A47C 3/029;
A47C 7/16; A47C 4/025
See application file for complete search history.

U.S. PATENT DOCUMENTS

D136,165 S *	8/1943	Reach	D6/348
3,899,208 A *	8/1975	Cirigliano	A47C 3/029 297/271.5
D256,071 S *	7/1980	Hershberger	D6/371
4,241,949 A *	12/1980	Parker	A47C 3/029 297/271.5
D361,904 S *	9/1995	Reese	D6/371
D371,011 S *	6/1996	Burstein	D6/373

* cited by examiner

Primary Examiner — Mimosa De

(57) **CLAIM**
I claim the ornamental design for a chair, as shown and described.

DESCRIPTION

FIG. 1 is a front perspective view of the chair;
FIG. 2 is a left side view of the chair;
FIG. 3 is a front view of the chair;
FIG. 4 is a right side view of the chair;
FIG. 5 is a rear view of the chair;
FIG. 6 is a top view of the chair; and,
FIG. 7 is a bottom view of the chair.

1 Claim, 4 Drawing Sheets

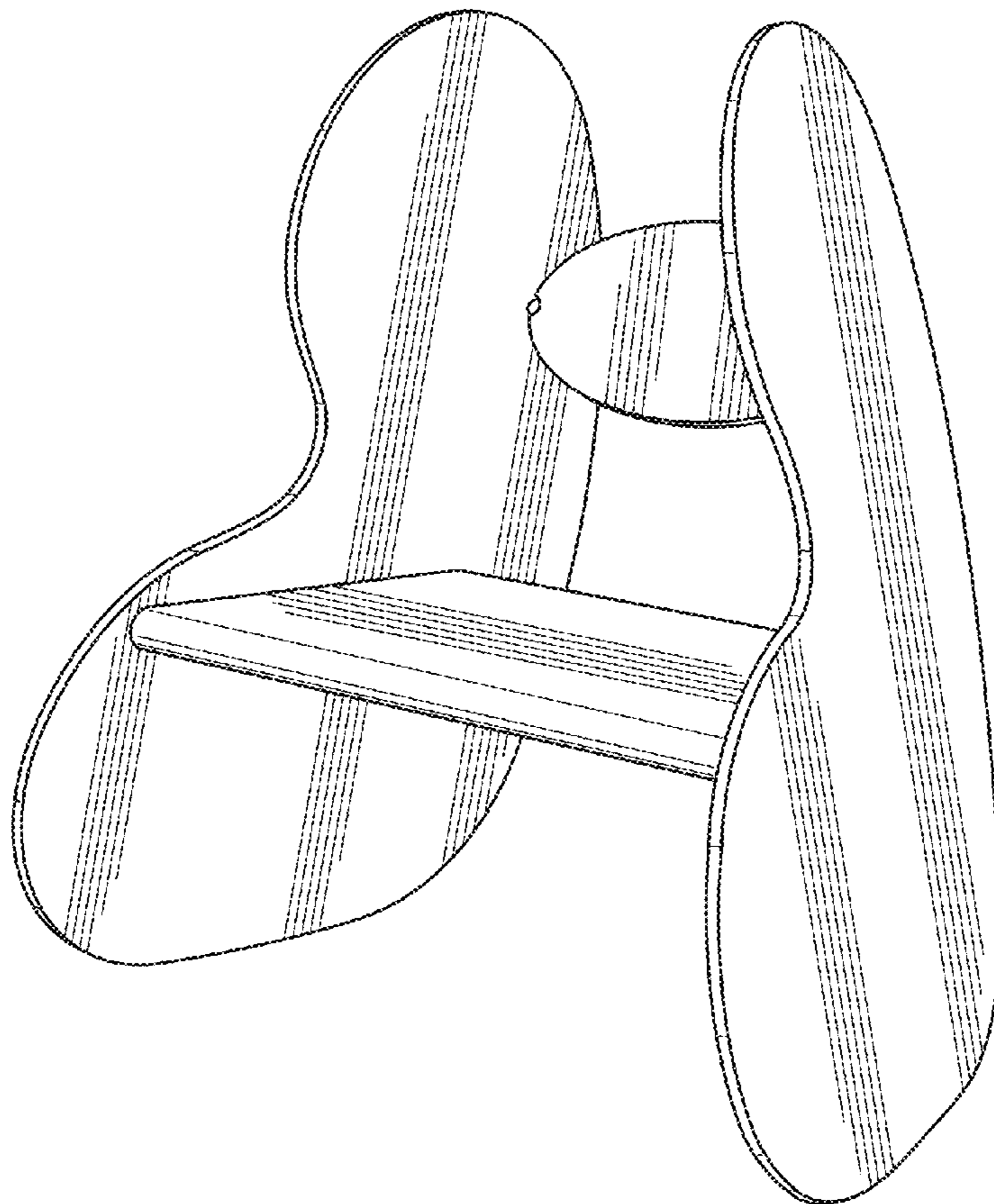
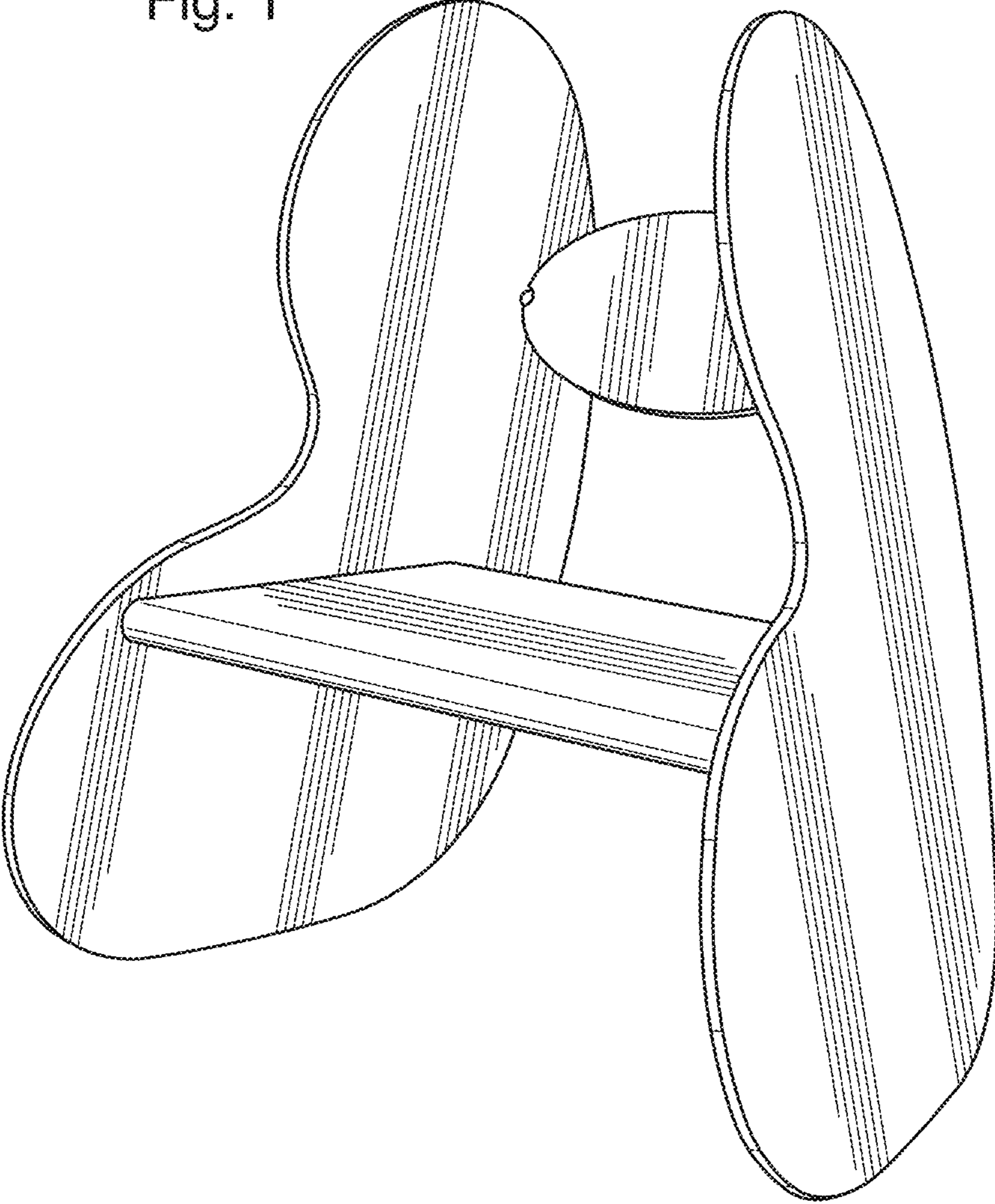

Fig. 1



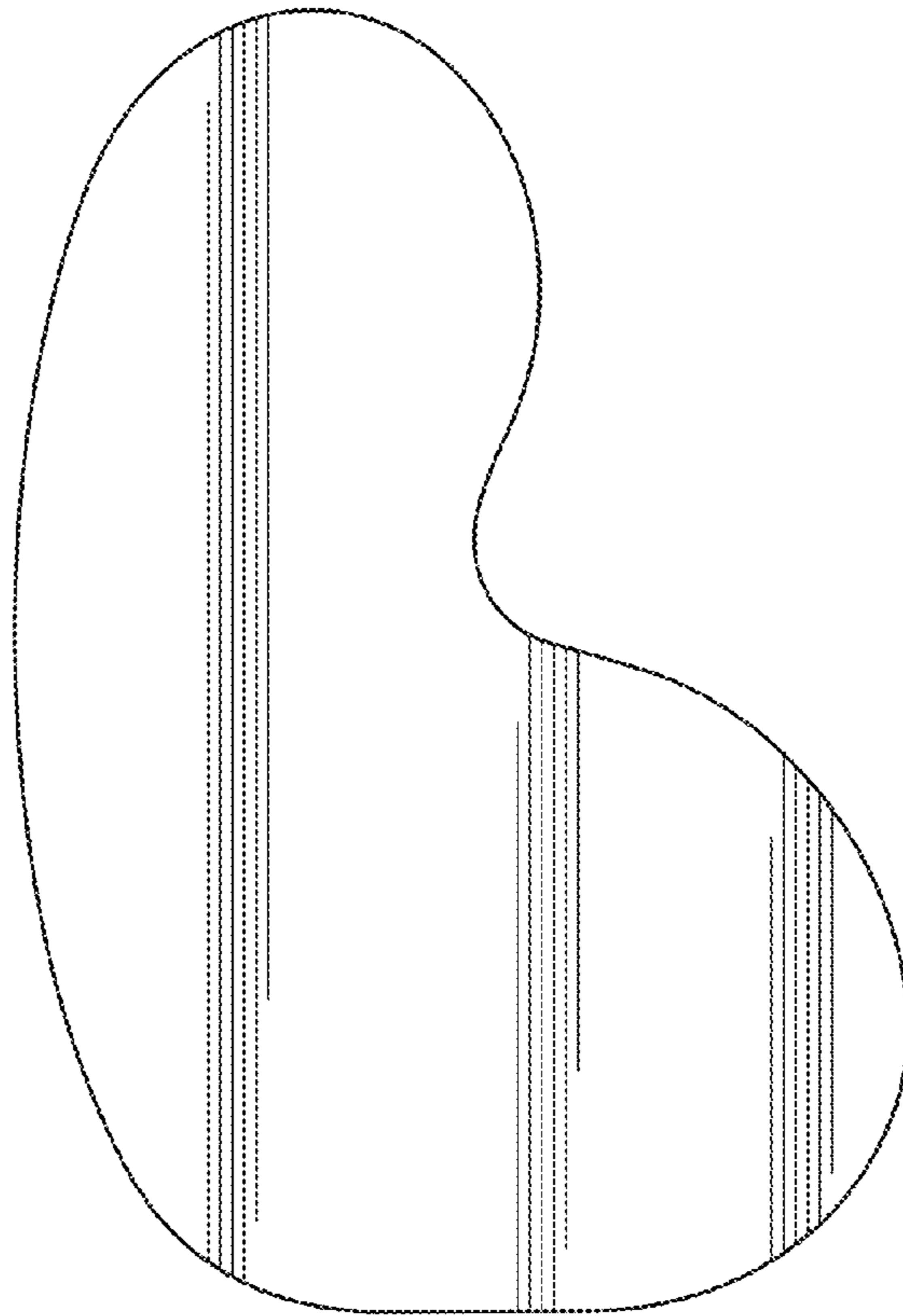
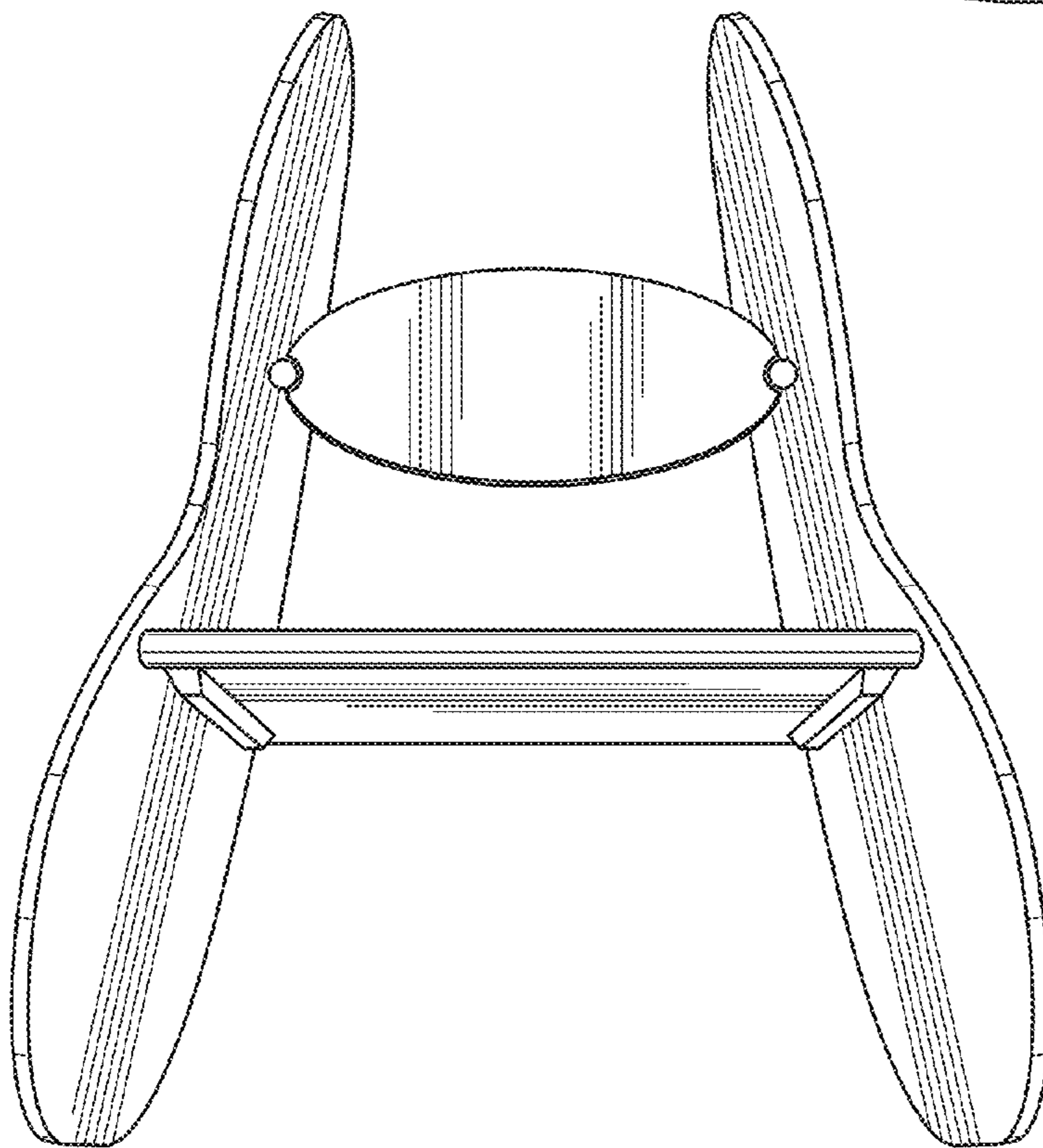

Fig. 2

Fig. 3



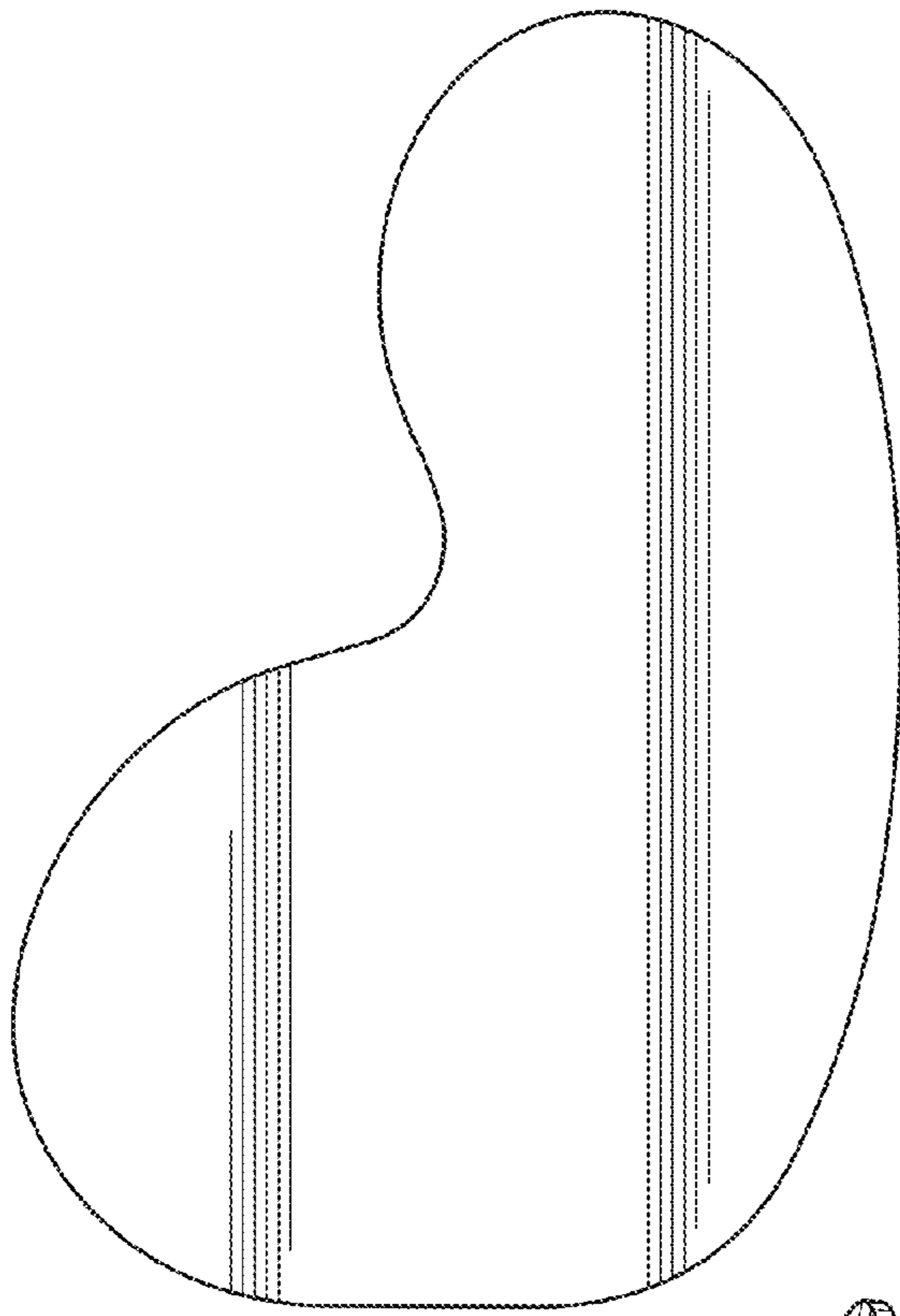

Fig. 4

Fig. 5

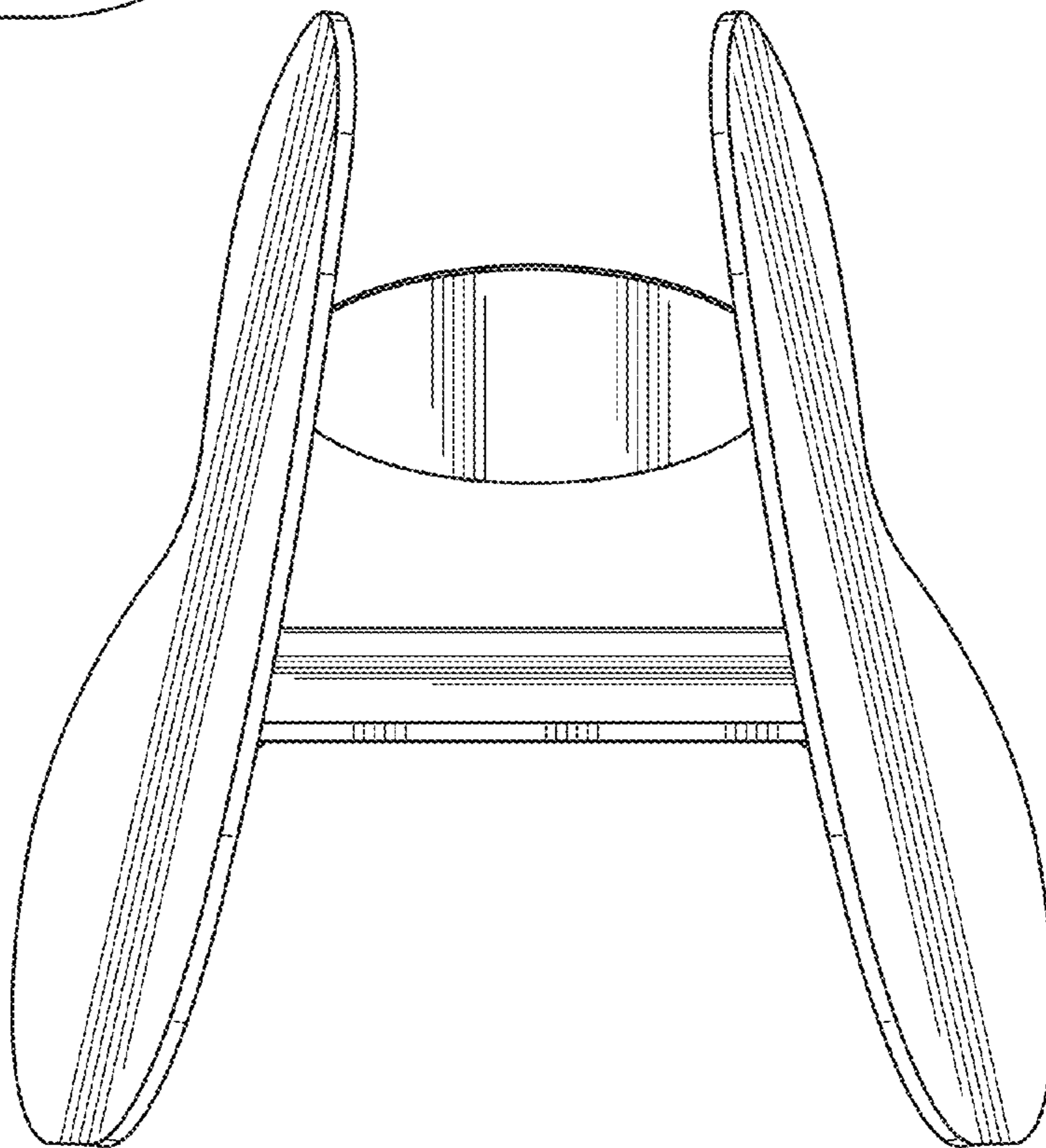

Fig. 6

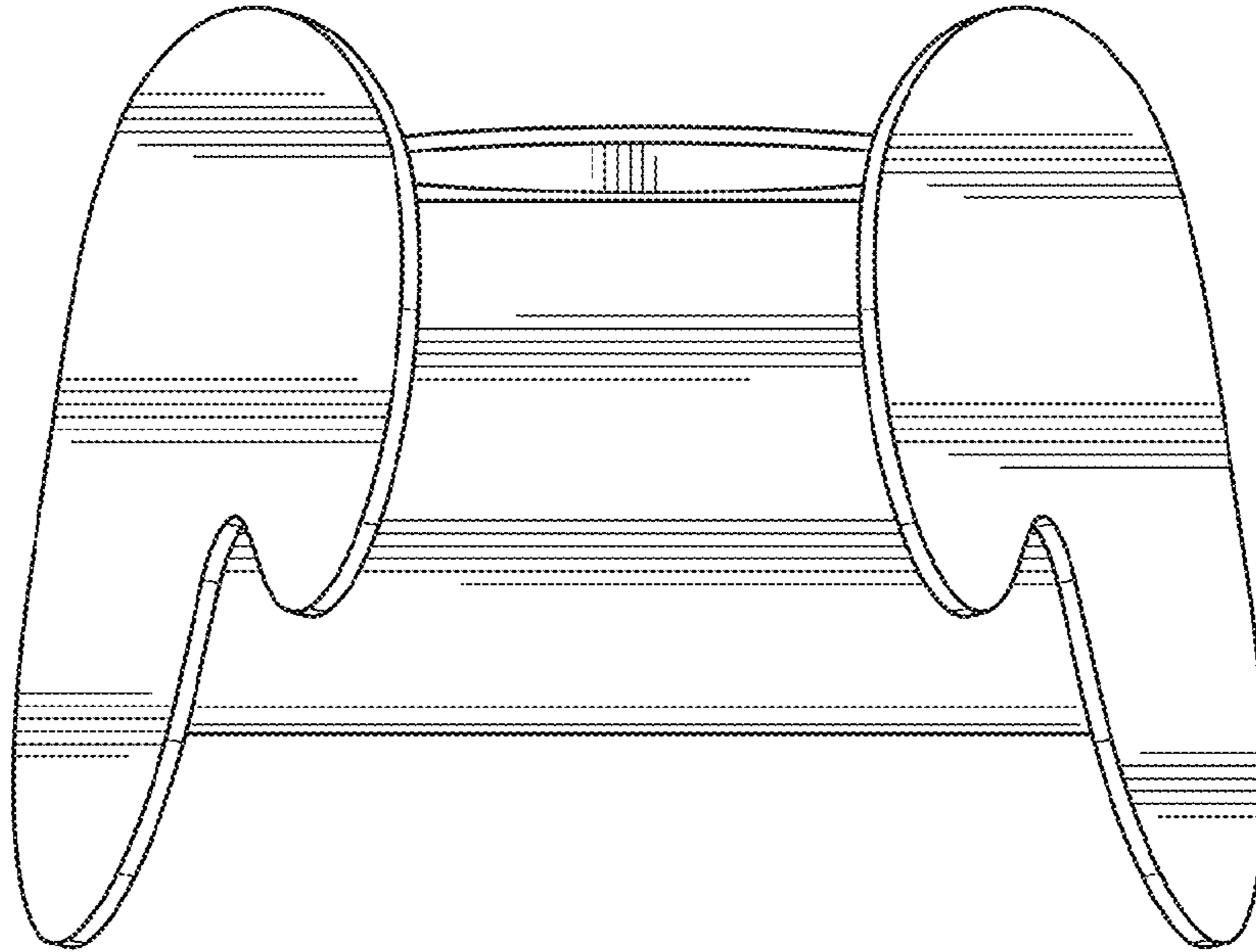

Fig. 7

