



US00D750913S

(12) **United States Design Patent**  
**Leathead**

(10) **Patent No.:** **US D750,913 S**  
(45) **Date of Patent:** **\*\* Mar. 8, 2016**

(54) **MULTIFORM CHAIR**

- (71) Applicant: **Designarium Inc.**, Laval (CA)
- (72) Inventor: **Stephane Leathead**, Laval (CA)
- (73) Assignee: **DESIGNARIUM INC.**, Laval, Quebec (CA)
- (\*\*) Term: **14 Years**
- (21) Appl. No.: **29/518,719**
- (22) Filed: **Feb. 26, 2015**

(30) **Foreign Application Priority Data**

Aug. 29, 2014 (CA) ..... 158437

(51) **LOC (10) Cl.** ..... **06-01**

(52) **U.S. Cl.**  
USPC ..... **D6/368**

(58) **Field of Classification Search**  
USPC ..... D6/334-336, 361, 368, 370, 371, 372,  
D6/716, 716.1, 716.2, 716.4  
CPC ..... A47C 4/03; A47C 4/04; A47C 4/08;  
A47C 4/045; A47C 4/021; A47C 4/022  
See application file for complete search history.

(56) **References Cited**

**U.S. PATENT DOCUMENTS**

D240,873 S \* 8/1976 Lewis ..... D6/370  
4,235,473 A \* 11/1980 Aginar ..... A47C 4/022  
297/452.63  
D260,123 S \* 8/1981 Lamb ..... D6/368  
D260,459 S \* 9/1981 Lamb ..... D6/370  
4,322,109 A \* 3/1982 Thebaud ..... A47C 4/03  
297/56  
D289,468 S \* 4/1987 MacVeigh ..... D6/368  
4,743,068 A \* 5/1988 Gomes ..... A47C 4/03  
297/56  
5,501,541 A \* 3/1996 Gomes ..... A47C 4/022  
403/19  
5,588,695 A \* 12/1996 Gomes ..... A47C 4/03  
297/56  
6,824,221 B1 \* 11/2004 Tiffany, III ..... A47C 4/022  
297/451.4

**OTHER PUBLICATIONS**

- <http://www.caporasodesign.it/ita/TwistChair.html>.
- <http://competition.su/r/blog/2013/05/31--revolution-chair/>.
- <http://www.fastcodesign.com/1472994/flat-pack-magic-ten-amazing-folding-chairs>.
- <http://thedesigndesign.com/2011/02/flexible-furniture-la-bande-by-sarah-lovgren/>.
- <http://www.polopuentearanda.com/chair-modern-chair-wooden-reading-kosha>.
- <http://www.pleatfarm.com/2010/02/08/foldable-lounge-chair-dua-collection/>.
- <http://www.reforestteak.com/shop/spirit-song-lounge-chair/>.
- <http://www.diefabrik.org/product/show/3>.
- <http://plushemisphere.com/2014/06/elegant-collections-of-chair-furniture-designs/chair-eco-furniture-design-ideas/>.
- <https://www.pinterest.com/pin/96264510757501212/>.
- <http://www.homedecoratio.com/futuristic-outdoor-lounge-chair-design-ideas-by-yoann-henry-yvon.html>.
- [http://www.vrayguide.com/2010/11/free-stuff-for-download/vrayart\\_free\\_model\\_design\\_chair/](http://www.vrayguide.com/2010/11/free-stuff-for-download/vrayart_free_model_design_chair/).
- <http://www.outdoorloungechairs.org/outdoor-lounge-chairs-decorate-outdoors/>.

\* cited by examiner

*Primary Examiner* — Mimoso De

(74) *Attorney, Agent, or Firm* — Fraser Clemens Martin & Miller LLC; James D. Miller

(57) **CLAIM**

The ornamental design for a multiform chair, as shown and described.

**DESCRIPTION**

FIG. 1 is a top plan view of the multiform chair with two portions of the chair shown in a first deployed relative angular position;

FIG. 2 is a bottom plan view of the multiform chair in the first deployed relative angular position of FIG. 1;

FIG. 3 is a right side elevational view of the multiform chair in the first deployed relative angular position of FIG. 1;

FIG. 4 is a left side elevational view of the multiform chair in the first deployed relative angular position of FIG. 1;

FIG. 5 is a front elevational view of the multiform chair in the first deployed relative angular position of FIG. 1;

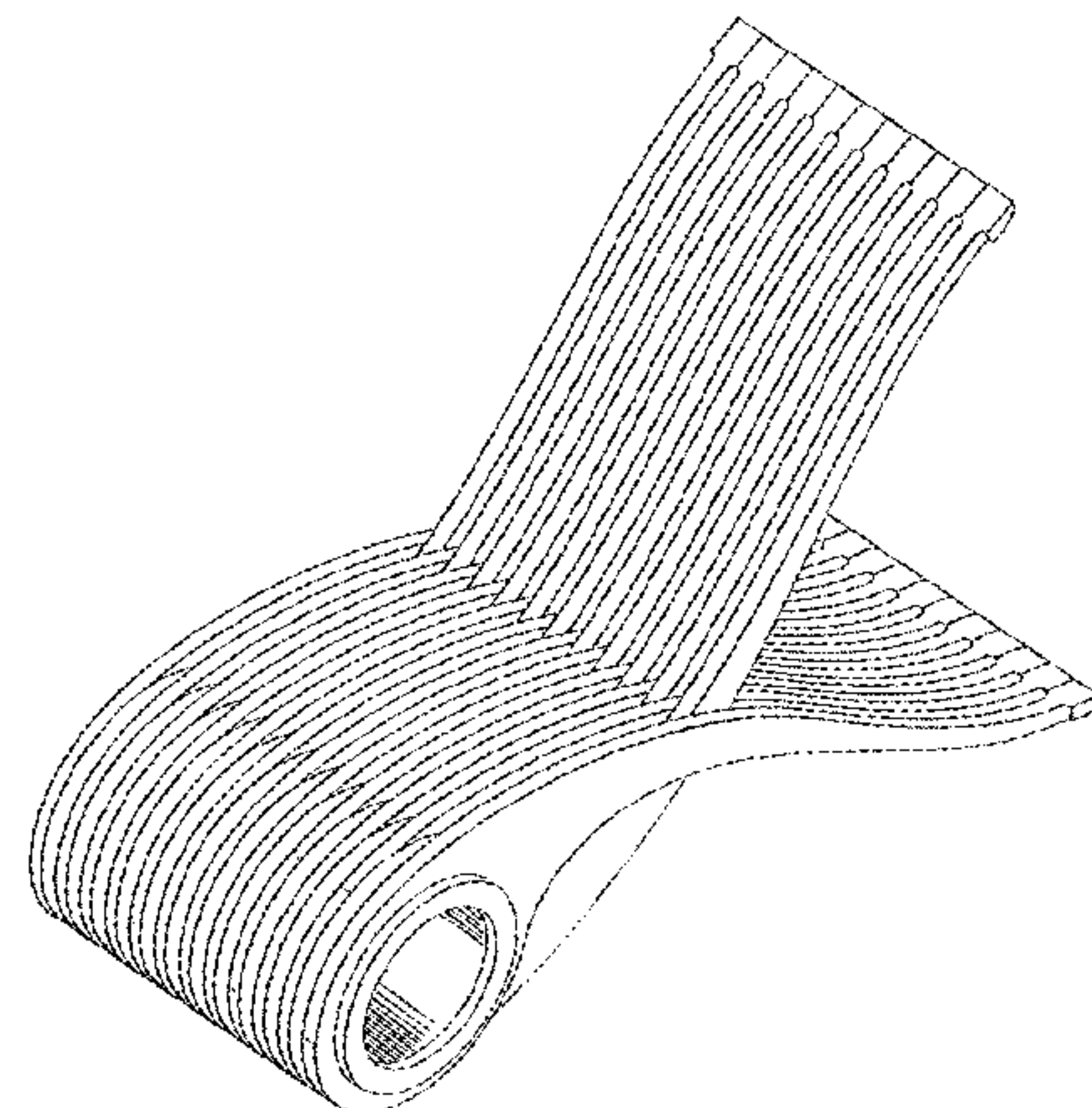
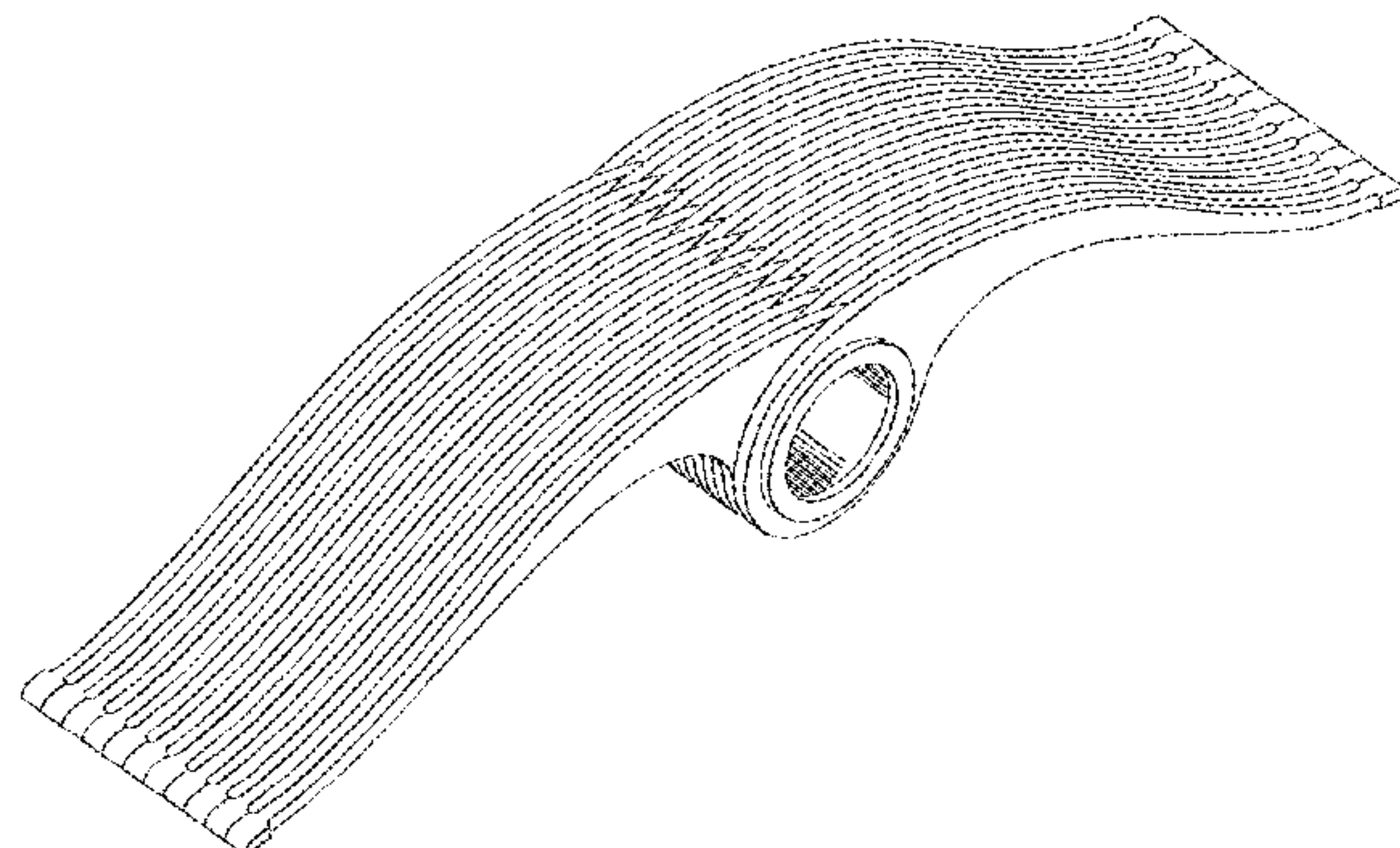

FIG. 6 is a rear elevational view of the multiform chair in the first deployed relative angular position of FIG. 1;

FIG. 7 is a perspective view of the multiform chair in the first deployed relative angular position of FIG. 1;

FIG. 8 is a top plan view of the multiform chair of FIG. 1, with the two portions of the chair shown in a second deployed right-angle relative angular position;

FIG. 9 is a bottom plan view of the multiform chair in the second deployed right-angle relative angular position of FIG. 8;

FIG. 10 is a right side elevational view of the multiform chair in the second deployed right-angle relative angular position of FIG. 8, wherein a left side elevational view is not shown as it is identical to the right side elevational view and pertinent design features can be ascertained from FIG. 4;

FIG. 11 is a front elevational view of the multiform chair in the second deployed right-angle relative angular position of FIG. 8;

FIG. 12 is a rear elevational view of the multiform chair in the second deployed right-angle relative angular position of FIG. 8;

FIG. 13 is a perspective view of the multiform chair in the second deployed right-angle relative angular position of FIG. 8;

FIG. 14 is a top plan view of the multiform chair of FIGS. 1 and 8, with the two portions of the chair shown in a third deployed partly collapsed relative angular position;

FIG. 15 is a bottom plan view of the multiform chair in the third deployed partly collapsed relative angular position of FIG. 14;

FIG. 16 is a right side elevational view of the multiform chair in the third deployed partly collapsed relative angular position of FIG. 14, wherein a left side elevational view is not

shown as it is identical to the right side elevational view and pertinent design features can be ascertained from FIG. 4;

FIG. 17 is a front elevational view of the multiform chair in the third deployed partly collapsed relative angular position of FIG. 14;

FIG. 18 is a rear elevational view of the multiform chair in the third deployed partly collapsed relative angular position of FIG. 14;

FIG. 19 is a perspective view of the multiform chair in the third deployed partly collapsed relative angular position of FIG. 14;

FIG. 20 is a top plan view of the multiform chair of FIGS. 1, 8, and 14, with the two portions of the chair shown in a fourth deployed partly collapsed relative angular position;

FIG. 21 is a bottom plan view of the multiform chair in the fourth deployed partly collapsed relative angular position of FIG. 20;

FIG. 22 is a right side elevational view of the multiform chair in the fourth deployed partly collapsed relative angular position of FIG. 20, wherein a left side elevational view is not shown as it is identical to the right side elevational view and pertinent design features can be ascertained from FIG. 4;

FIG. 23 is a front elevational view of the multiform chair in the fourth deployed partly collapsed relative angular position of FIG. 20;

FIG. 24 is a rear elevational view of the multiform chair in the fourth deployed partly collapsed relative angular position of FIG. 20; and,

FIG. 25 is a perspective view of the multiform chair in the fourth deployed partly collapsed relative angular position of FIG. 20.

The ornamental design which is claimed is shown in solid lines in the drawing figures.

**1 Claim, 9 Drawing Sheets**



FIGURE 1

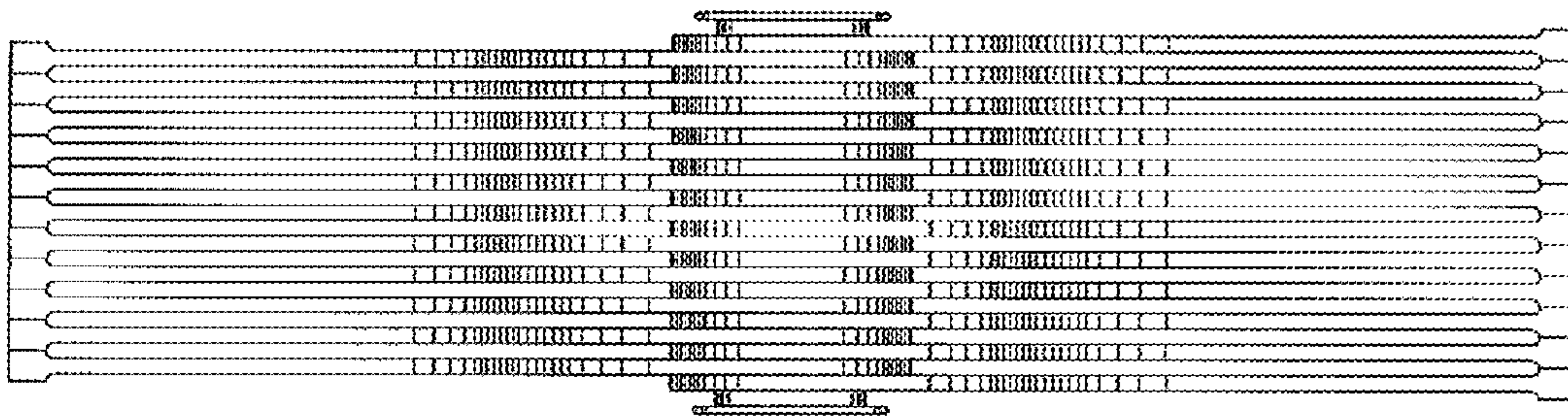

FIGURE 2

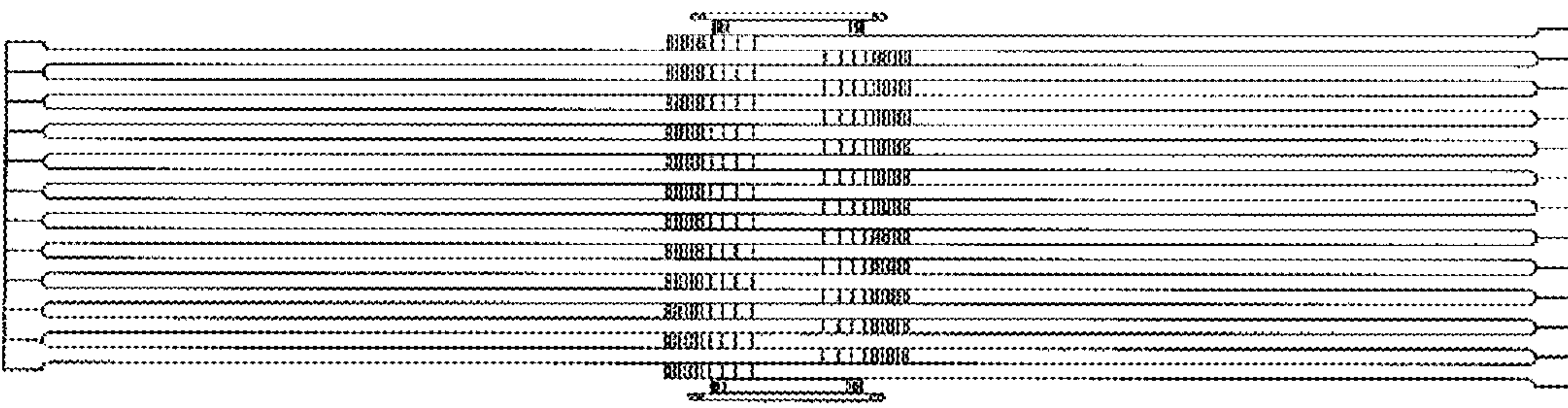

FIGURE 3

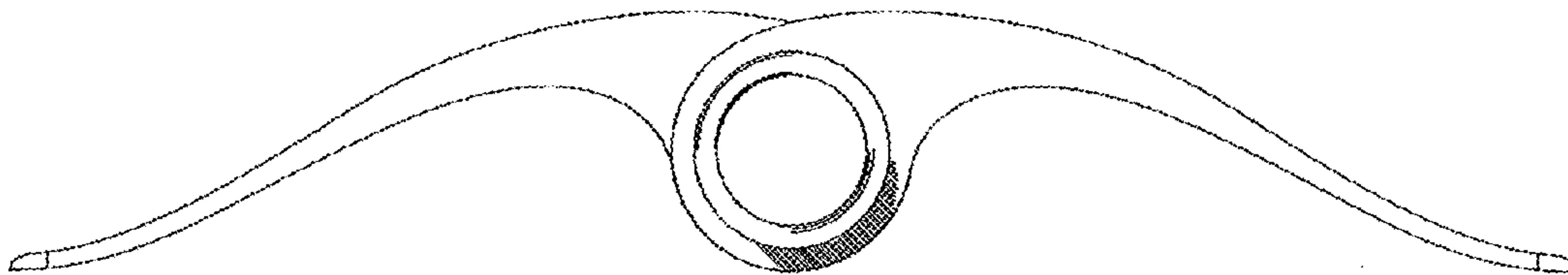

FIGURE 4

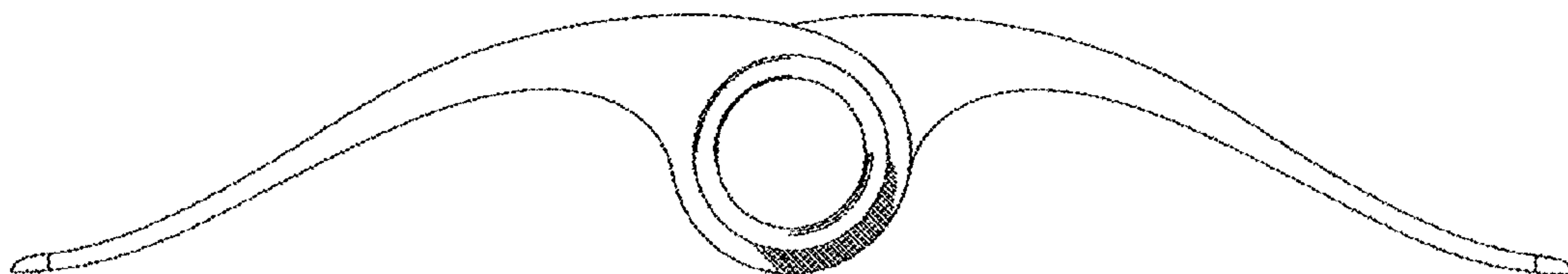

FIGURE 5

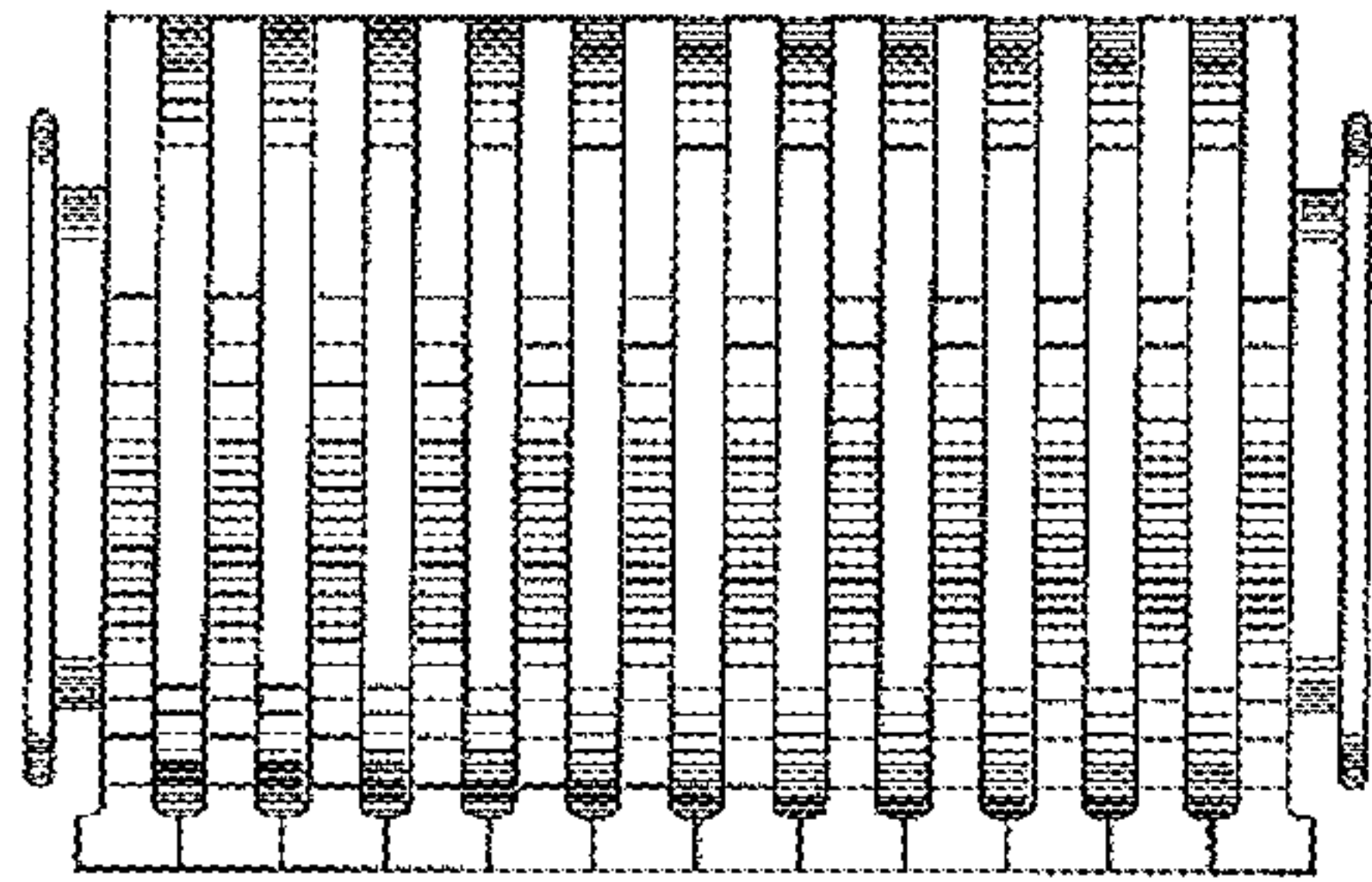

FIGURE 6

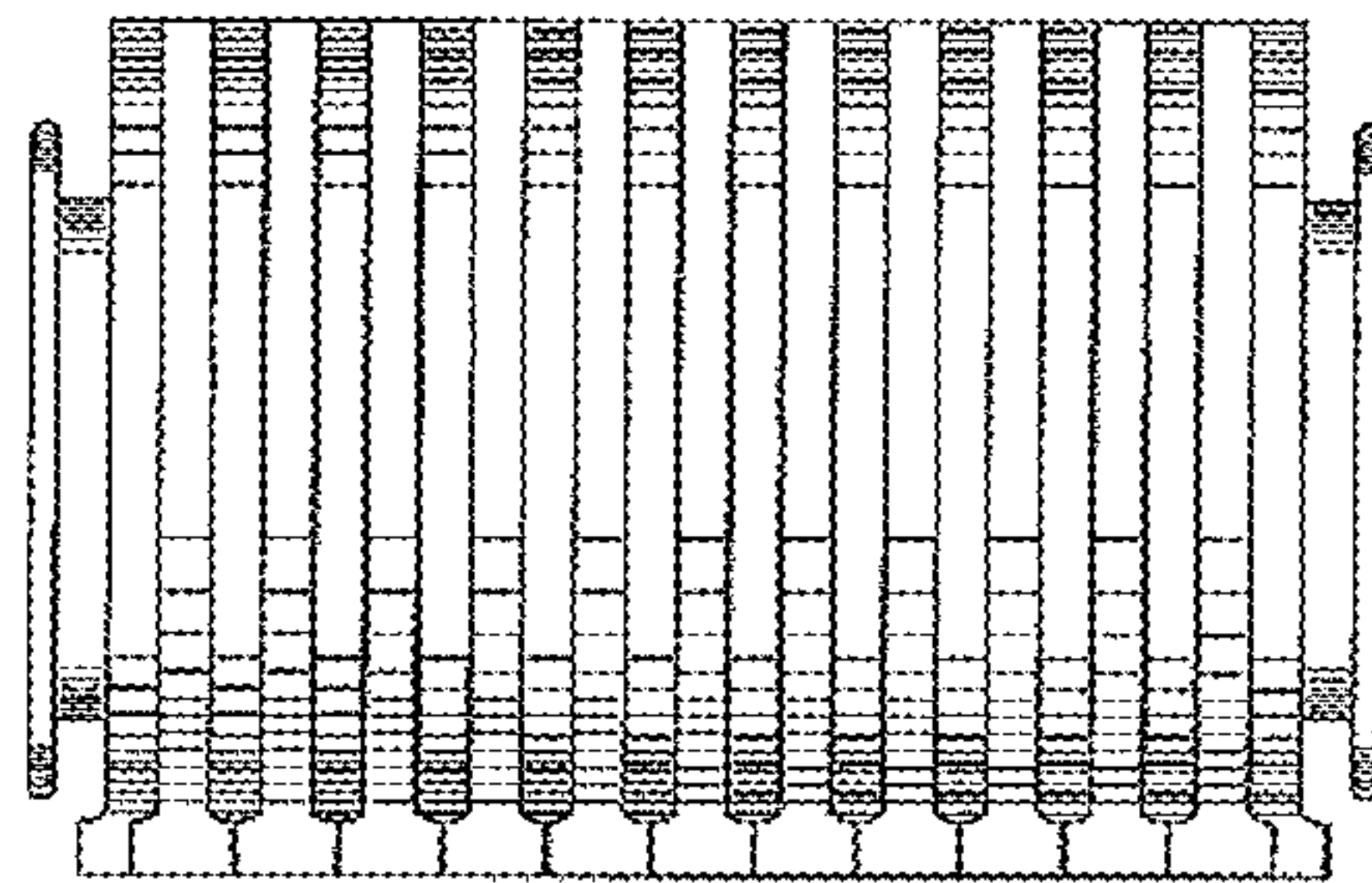

FIGURE 7

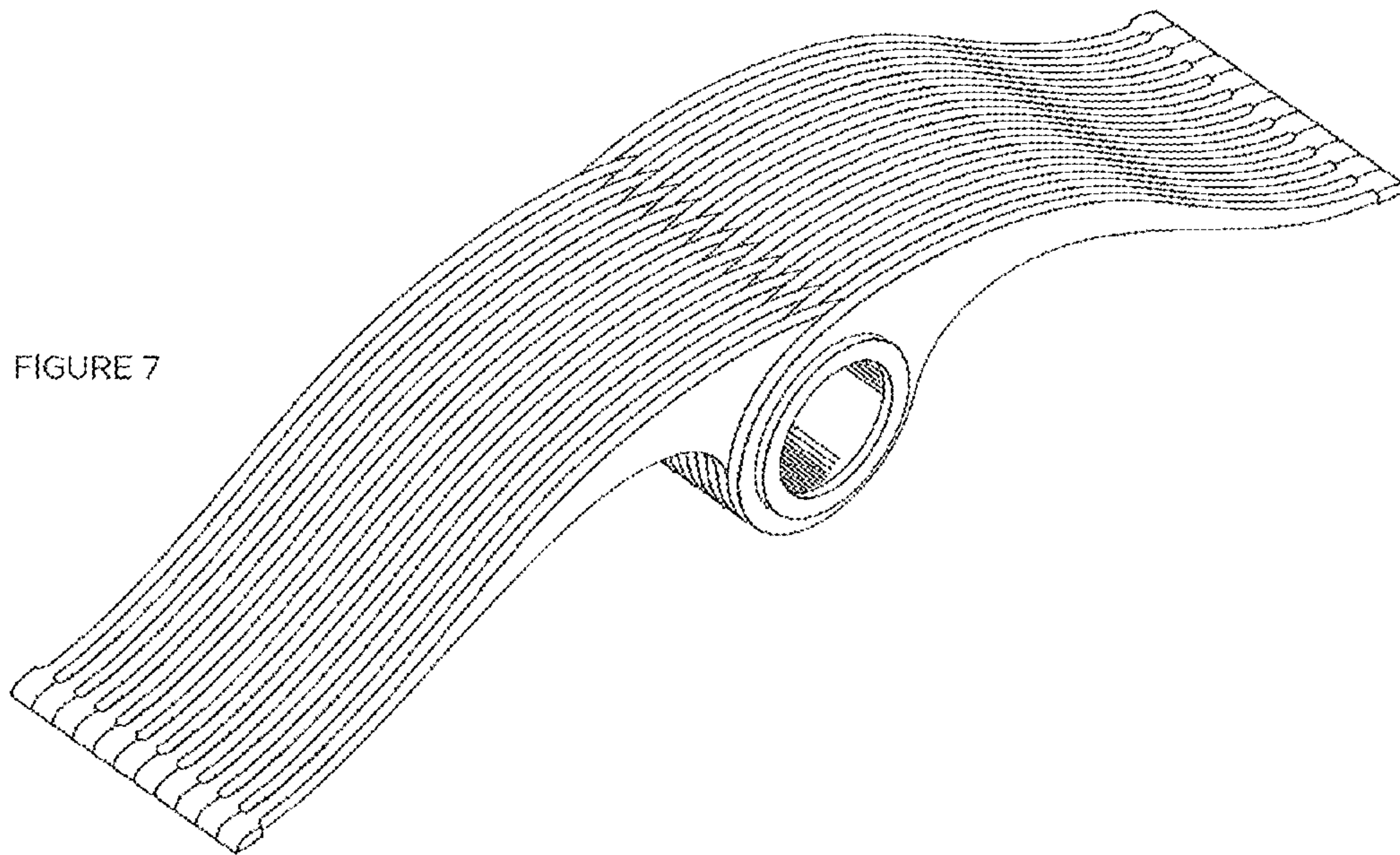

FIGURE 8

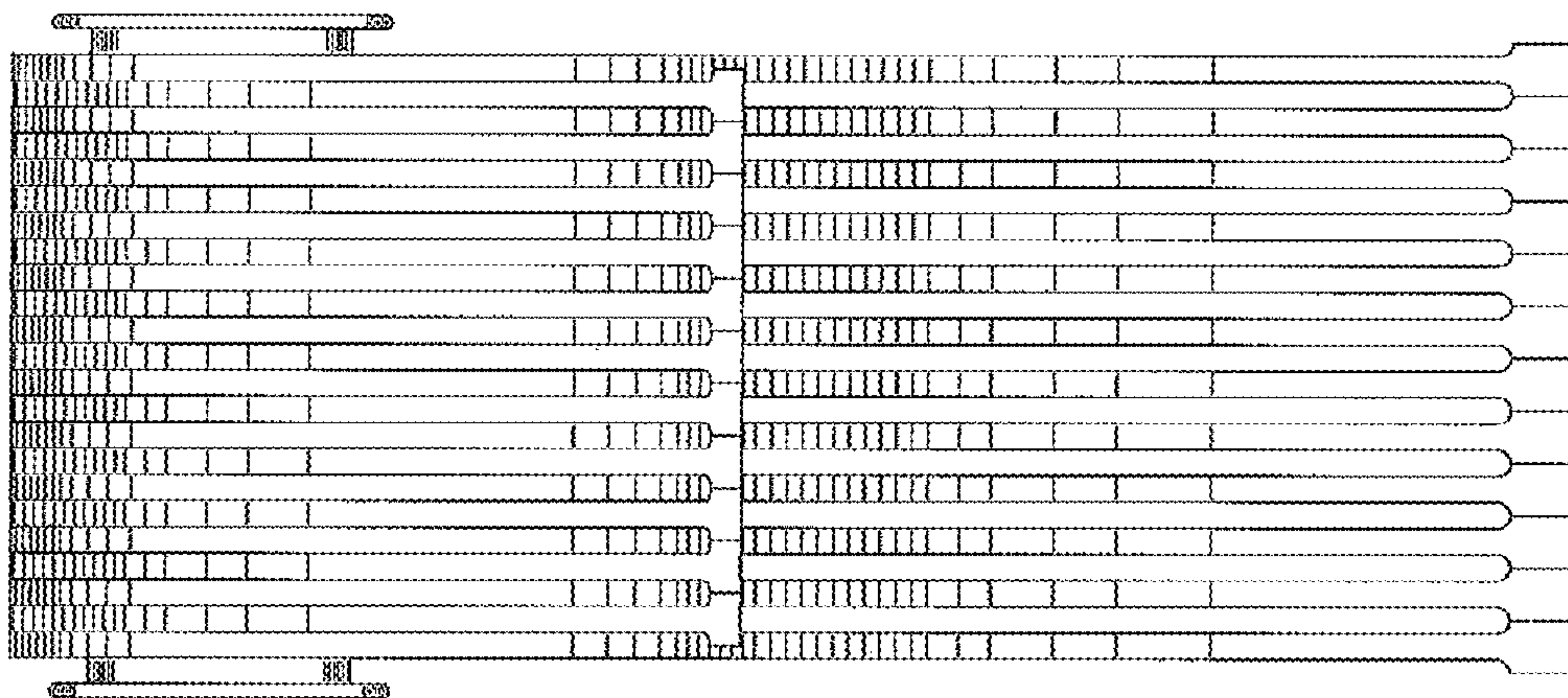

FIGURE 9

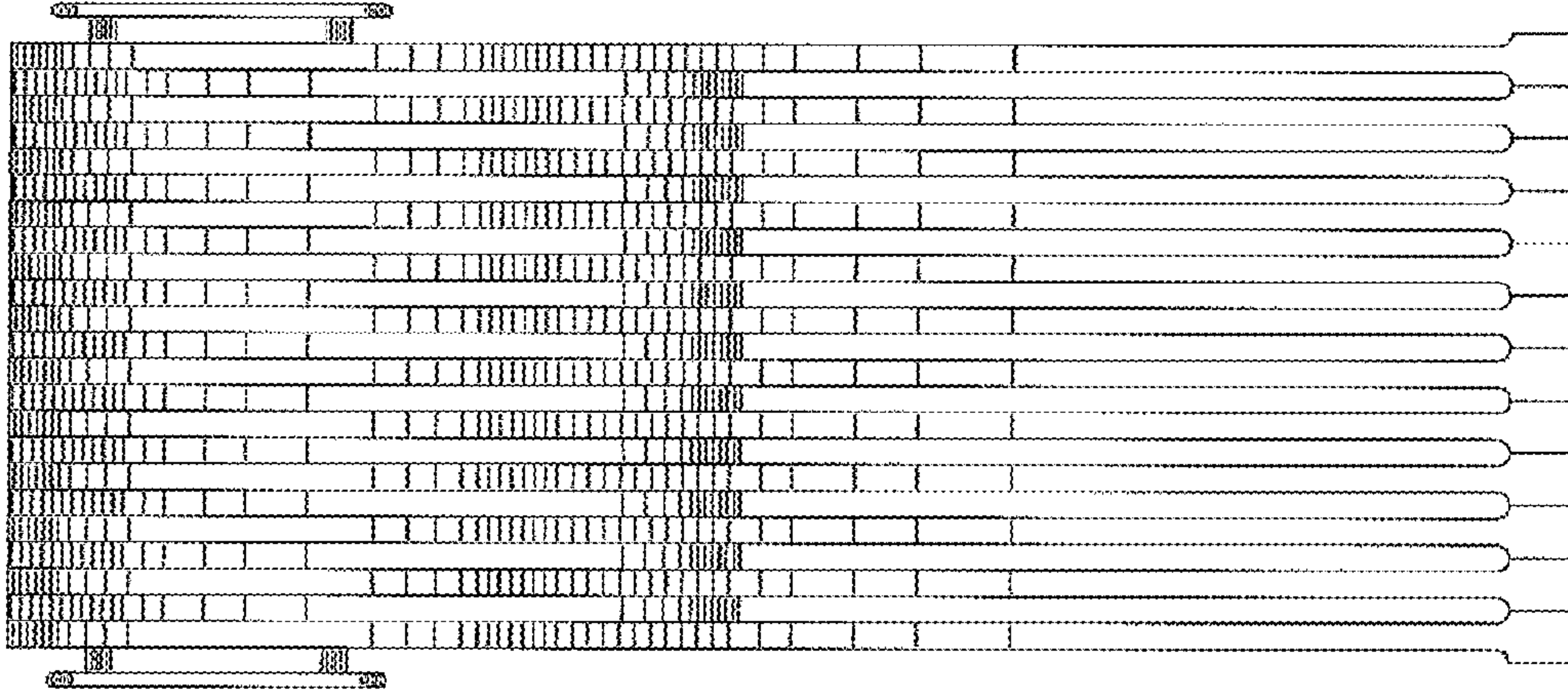

FIGURE 10

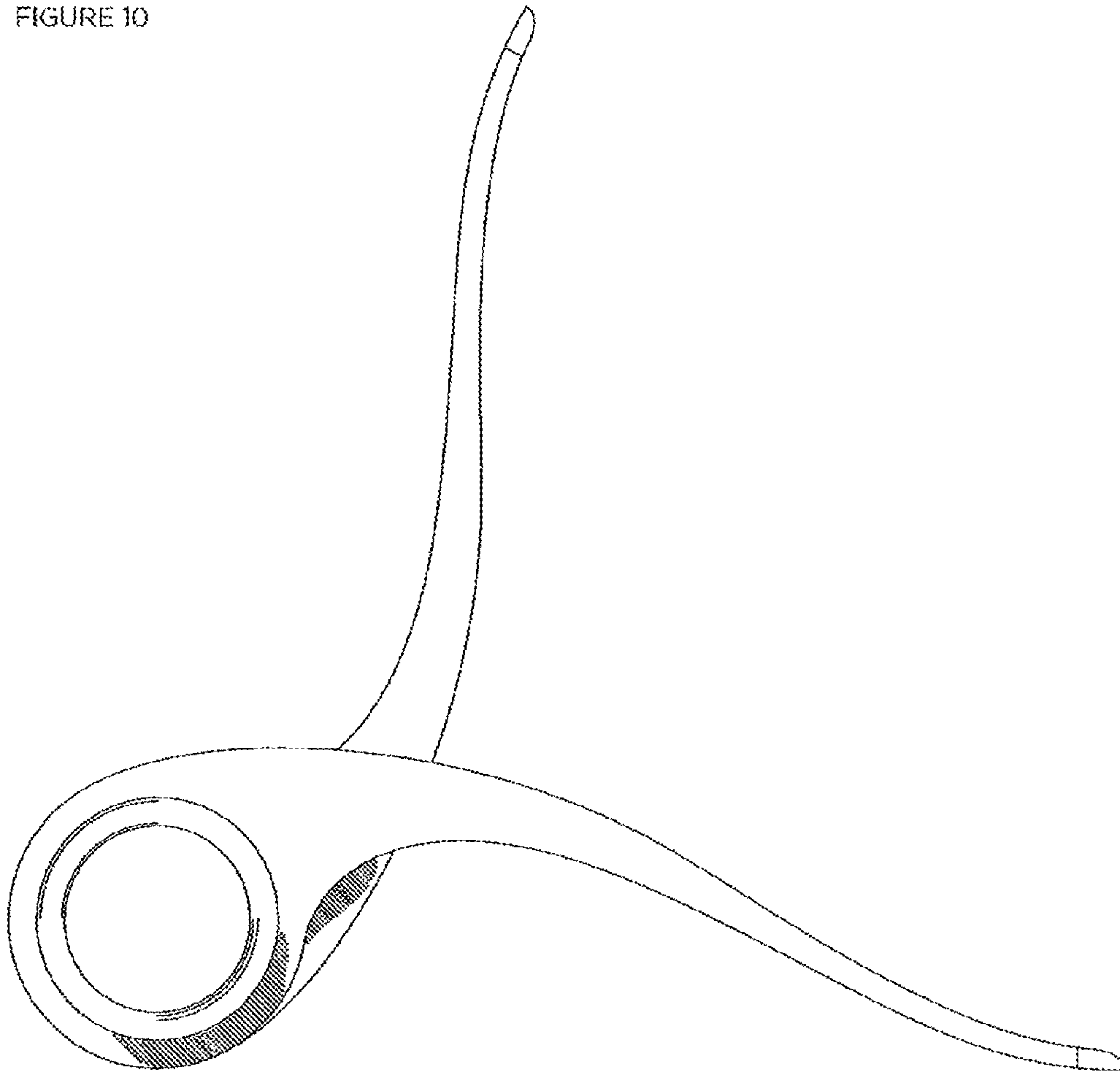



FIGURE 11

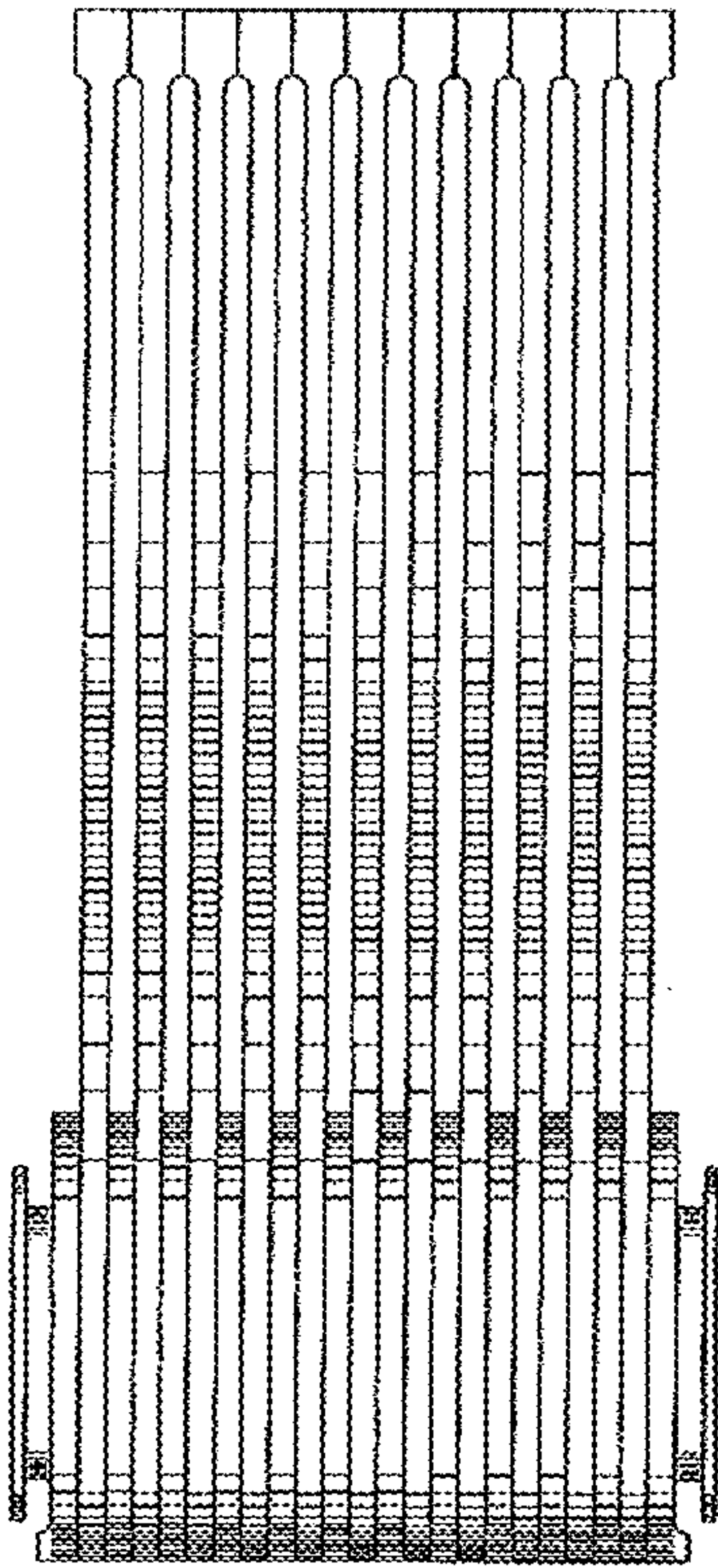

FIGURE 12

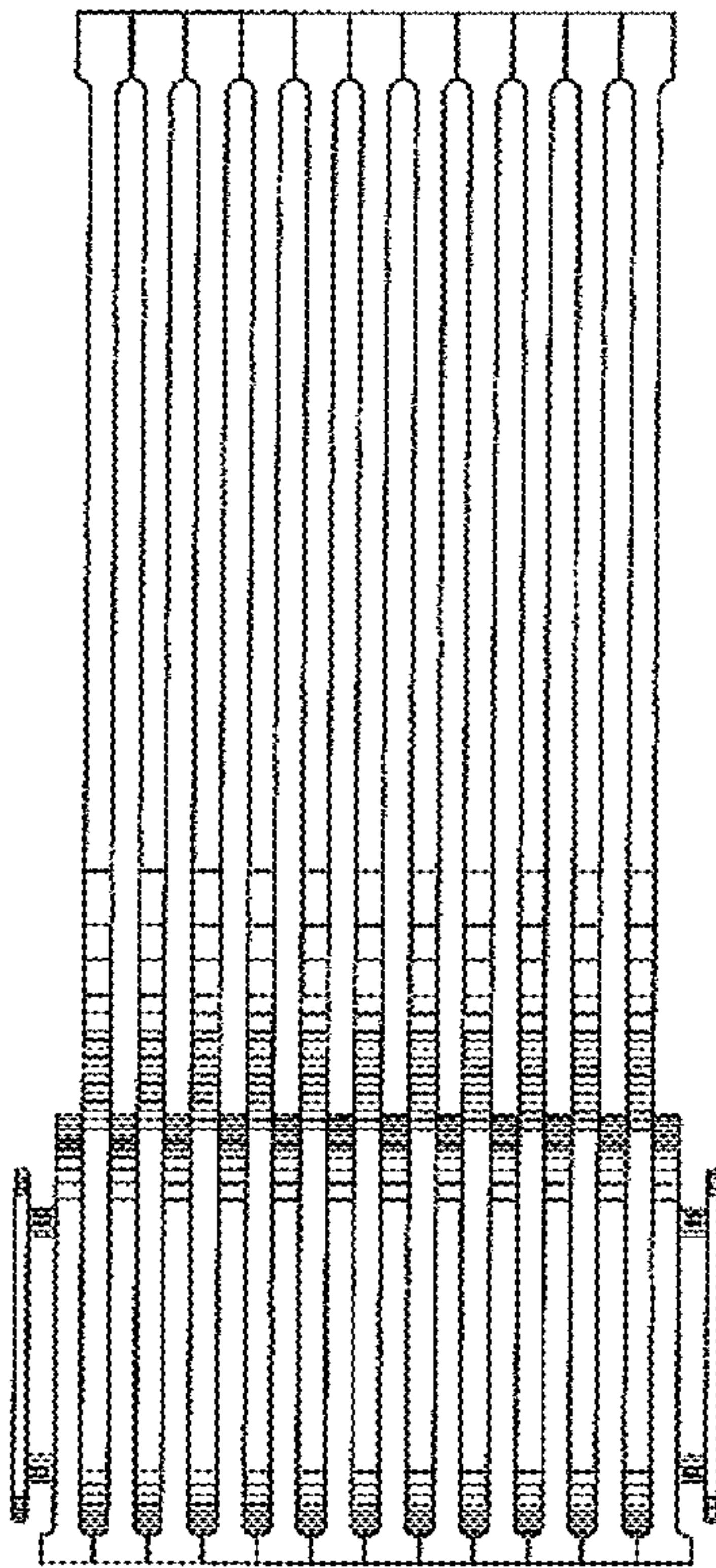

FIGURE 13

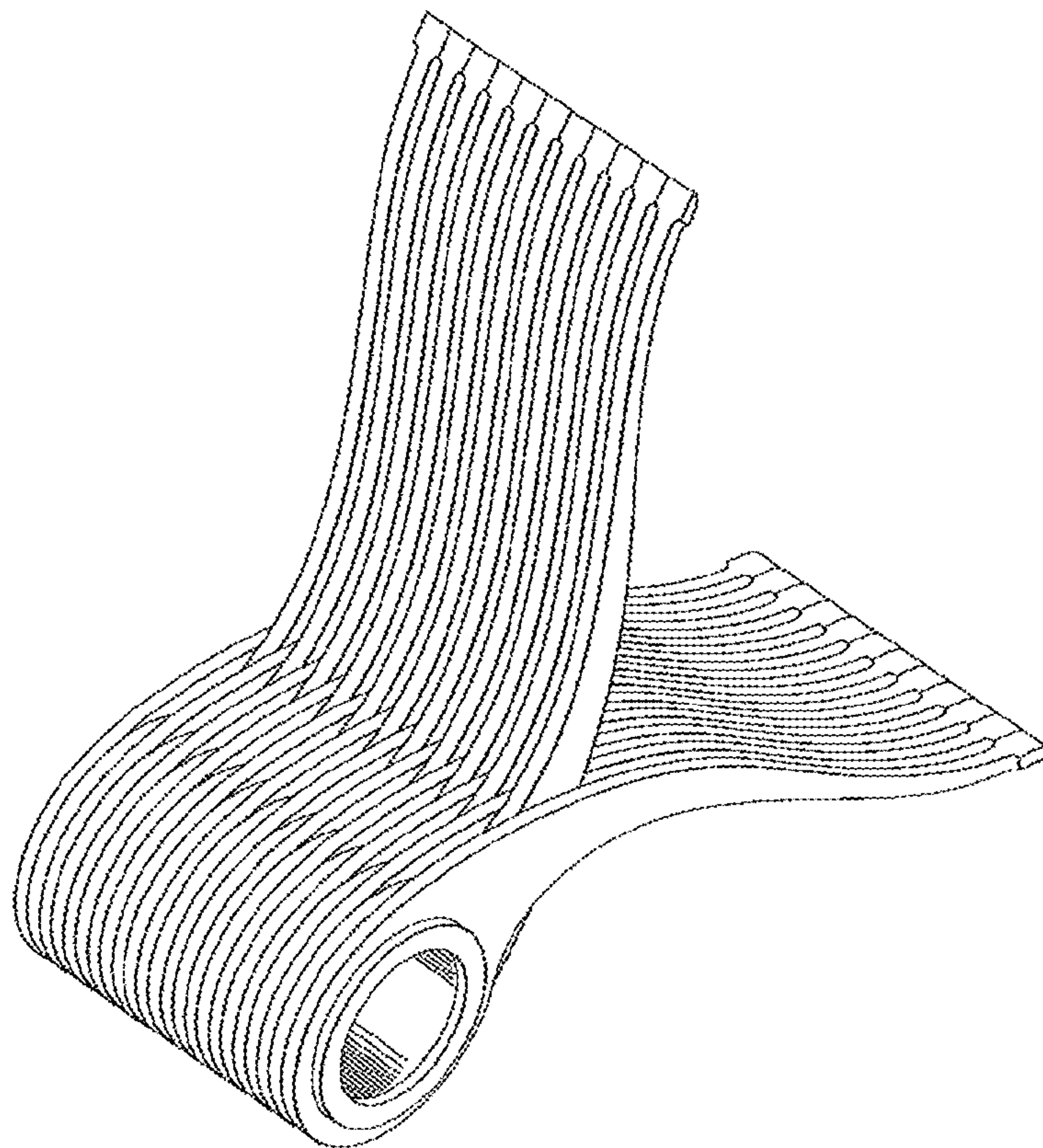

FIGURE 14

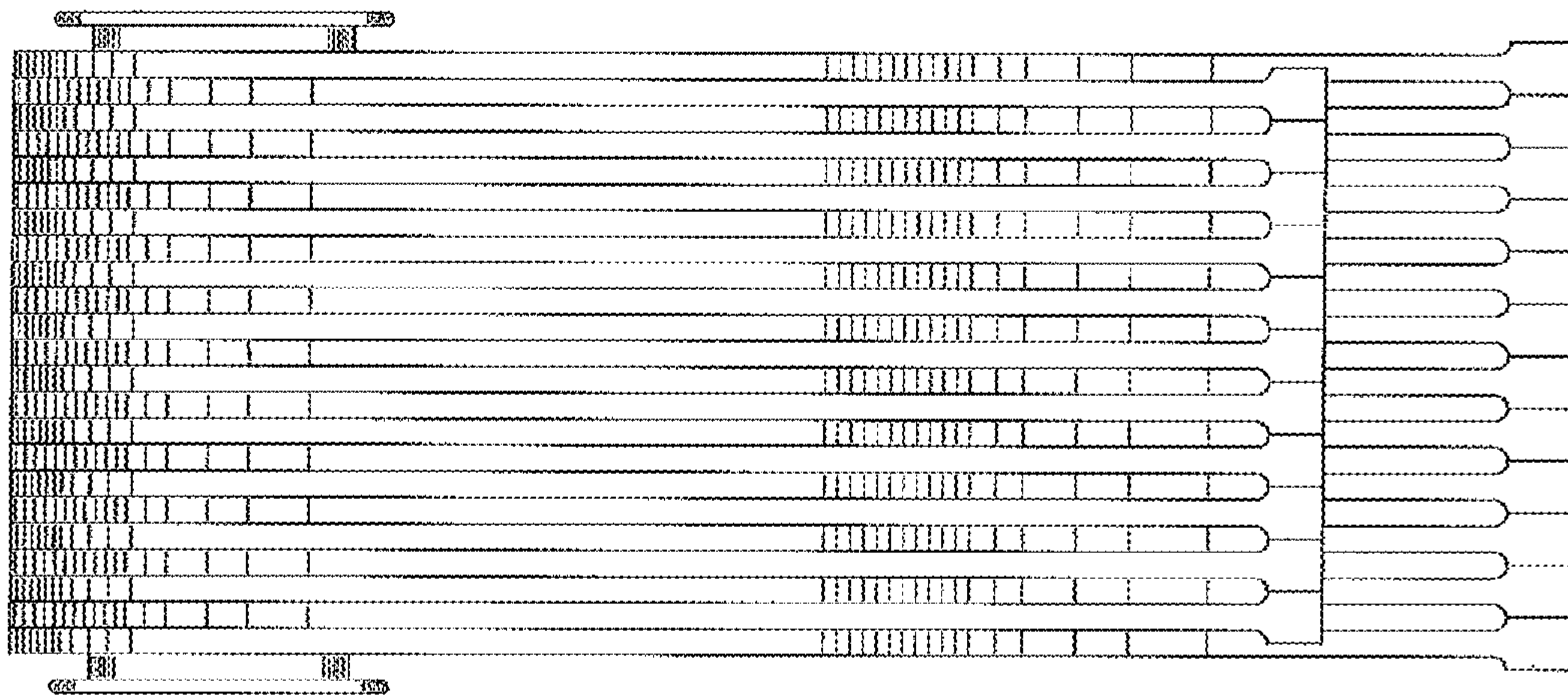

FIGURE 15

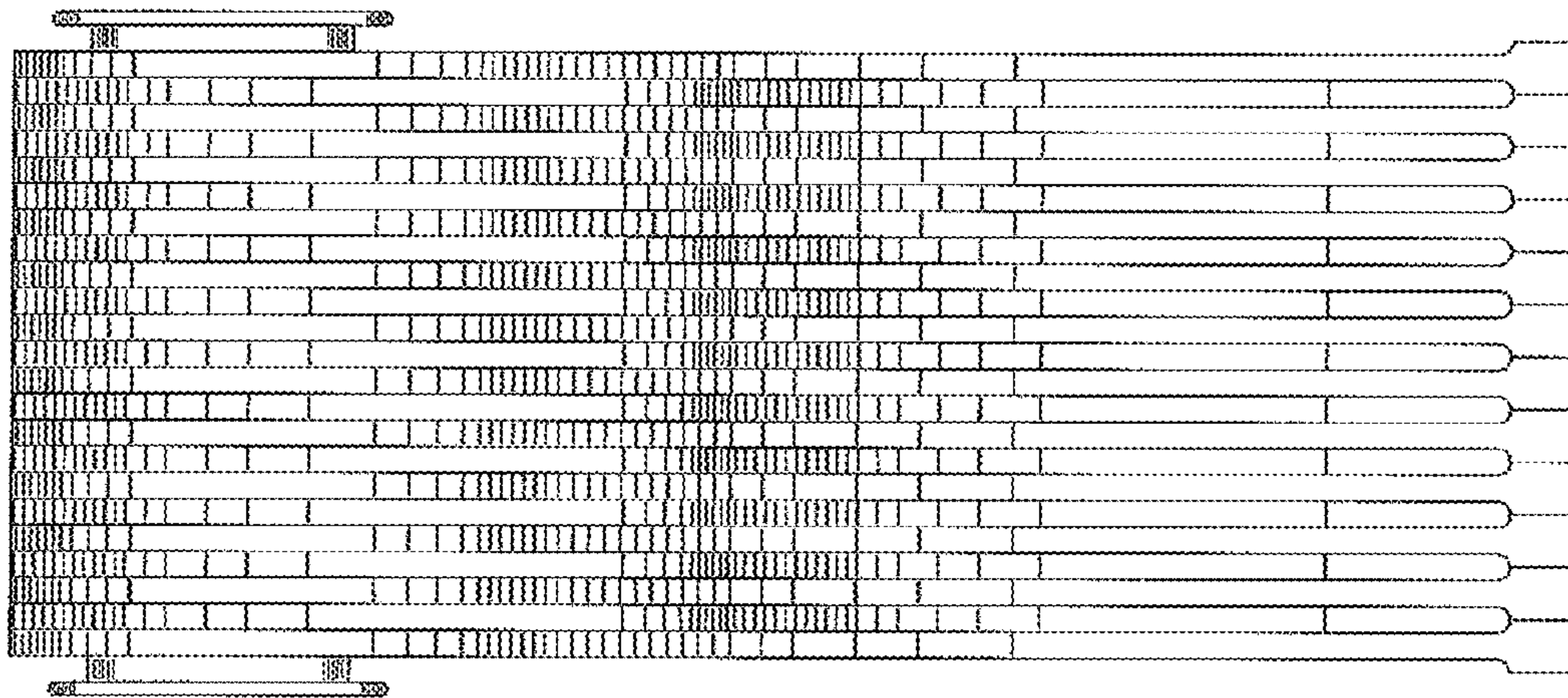



FIGURE 16

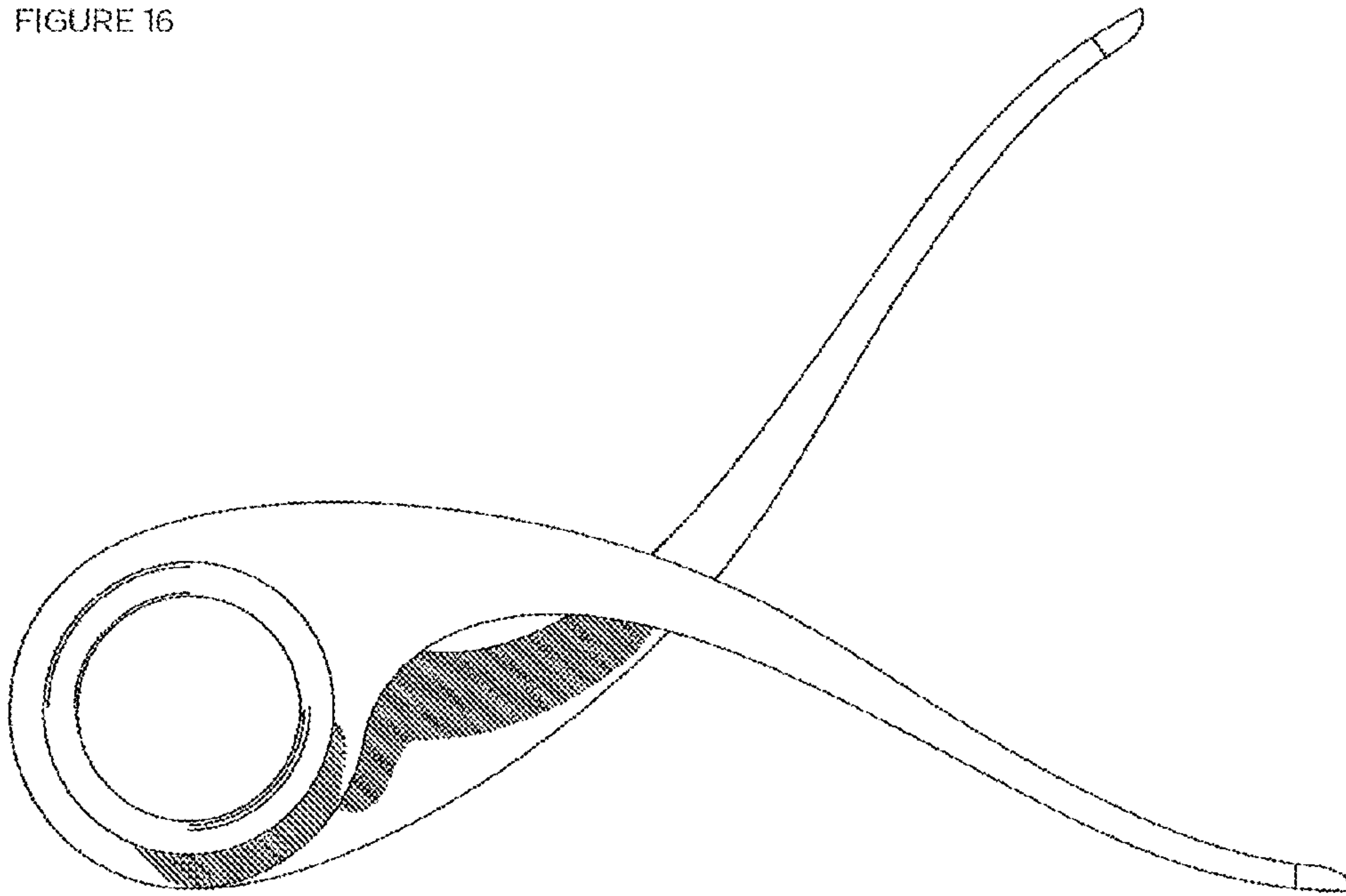

FIGURE 17

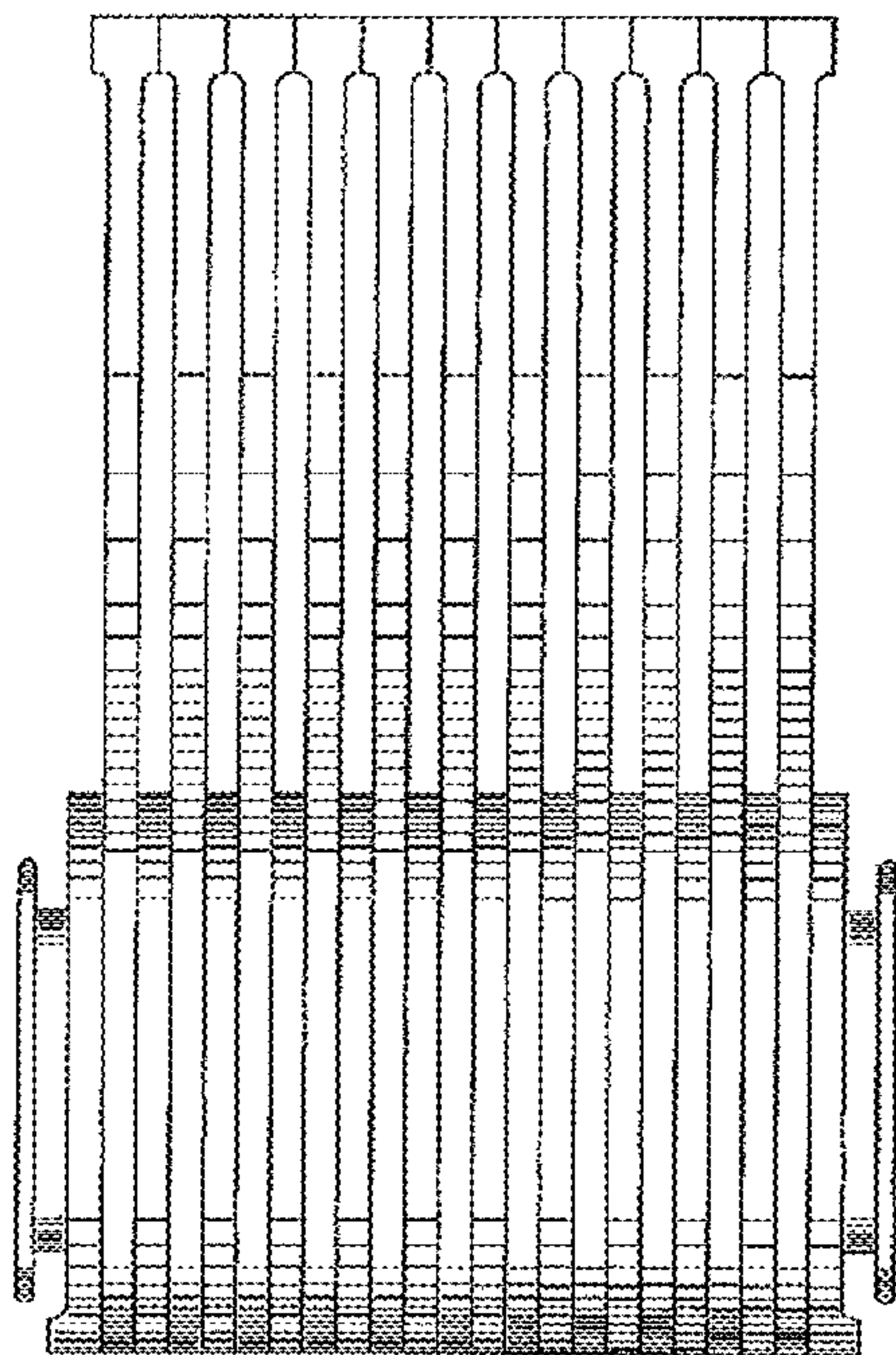

FIGURE 18

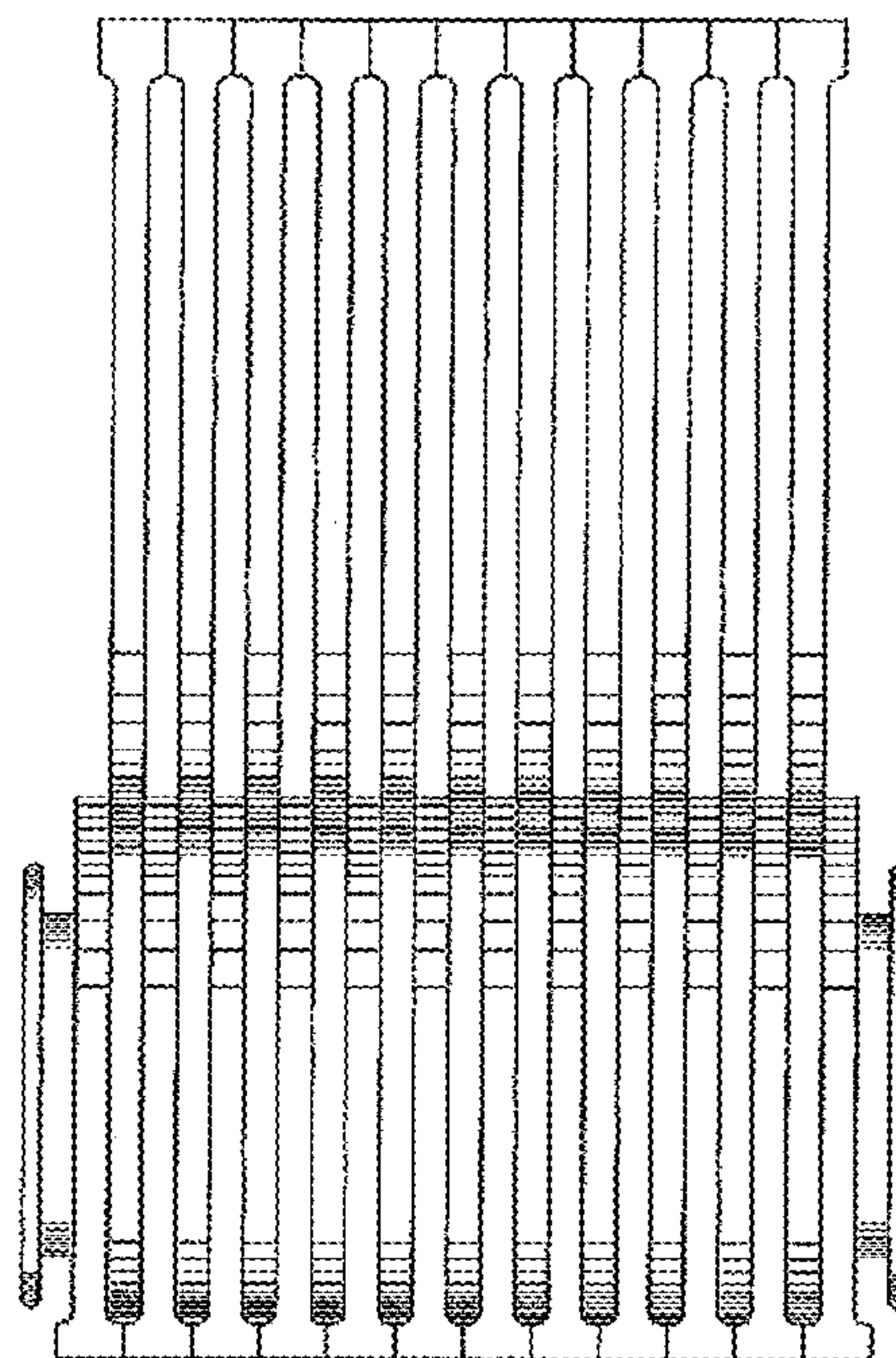



FIGURE 19

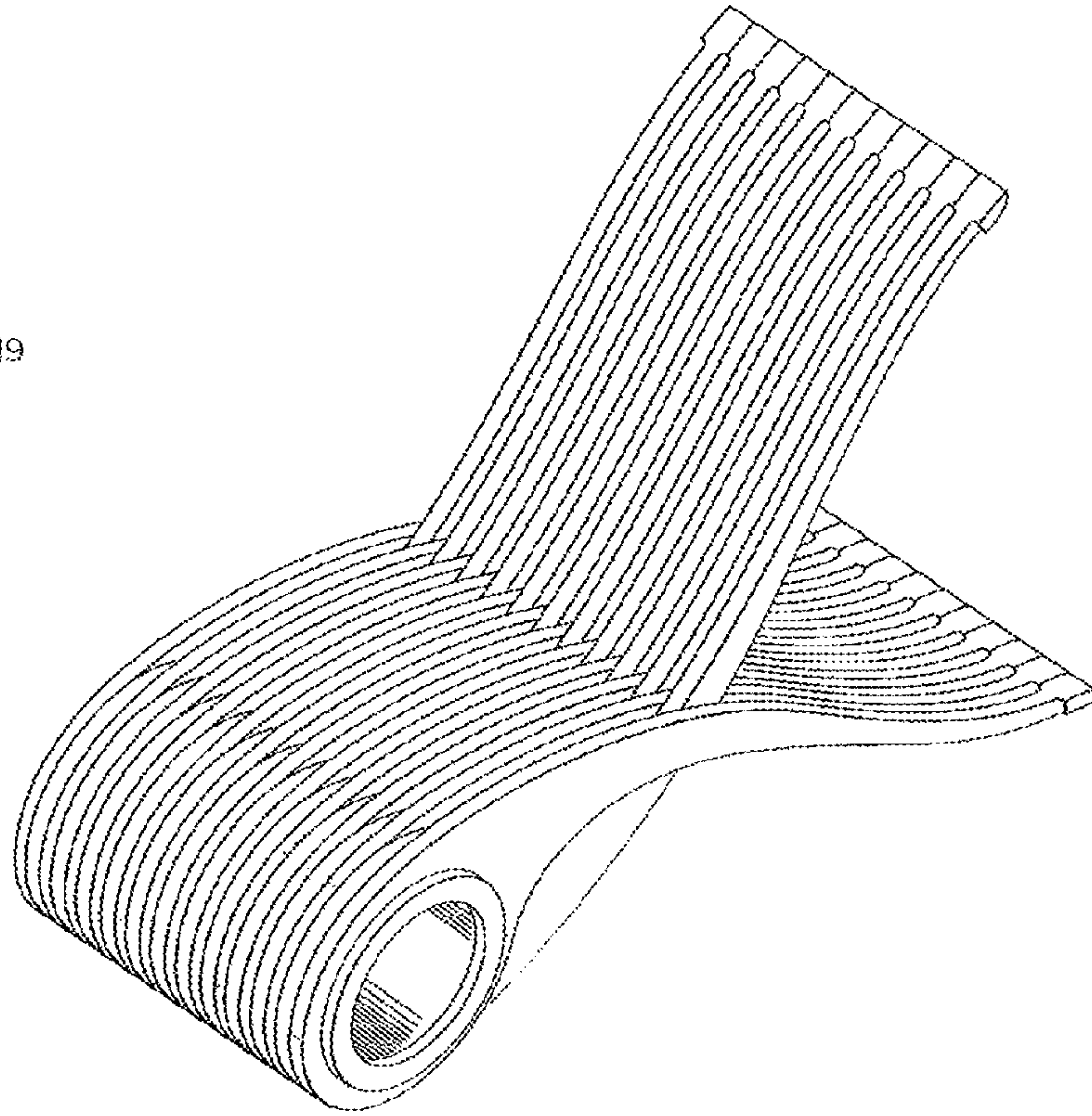

FIGURE 20

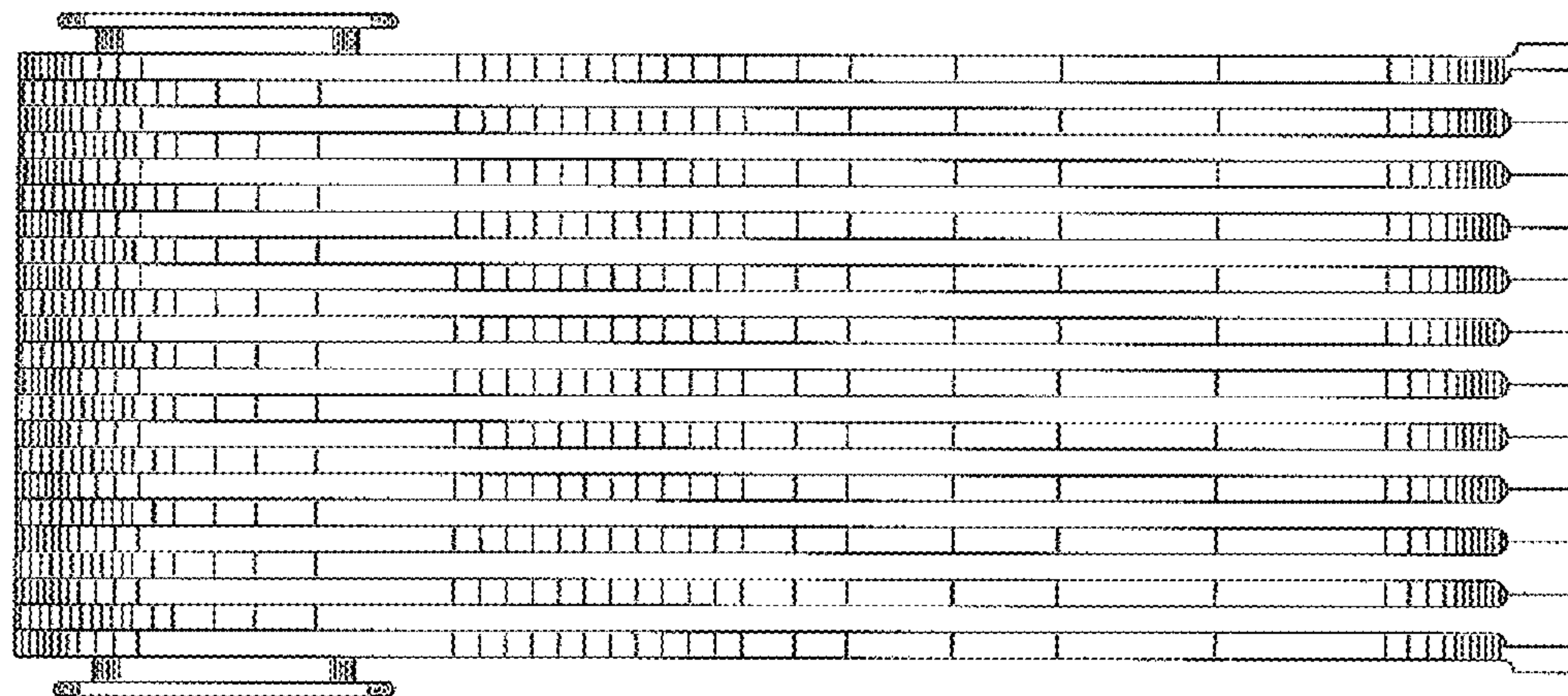

FIGURE 21

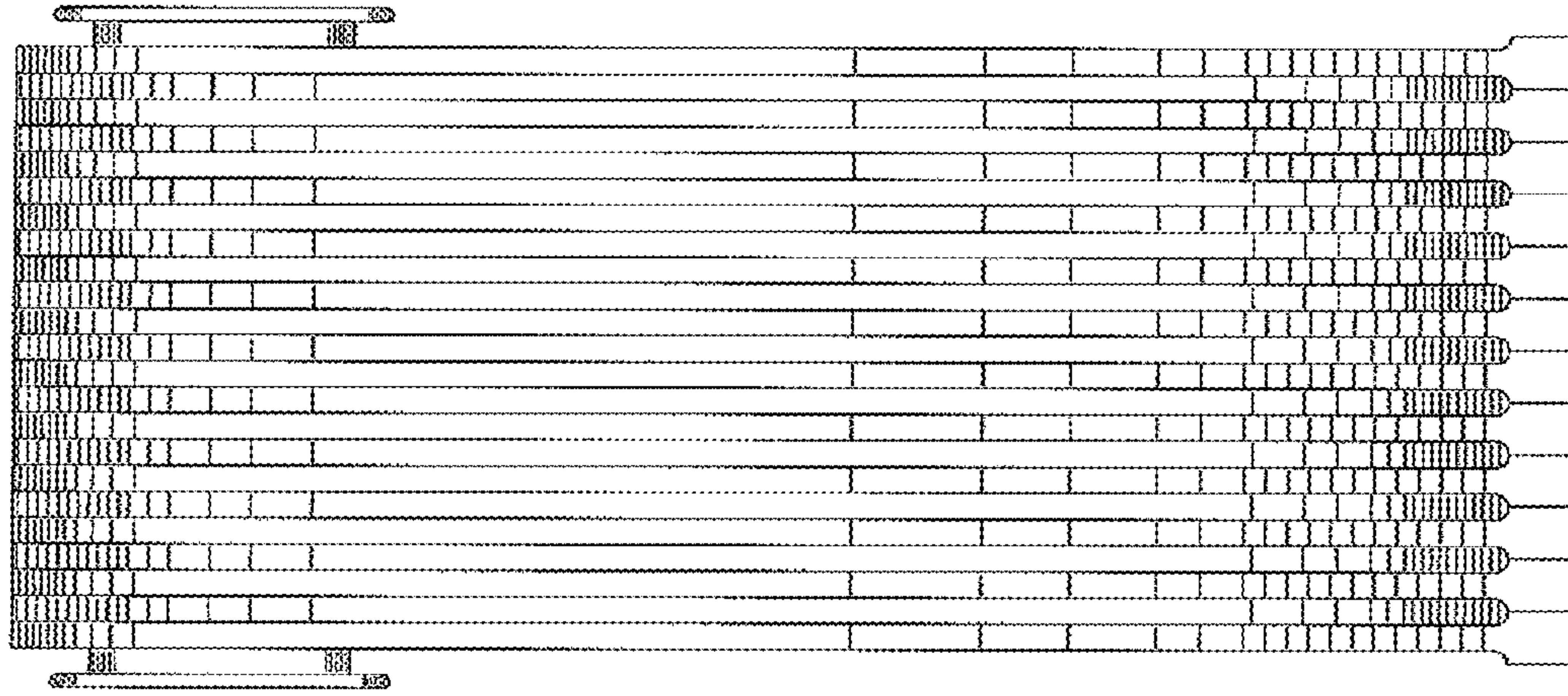

FIGURE 22

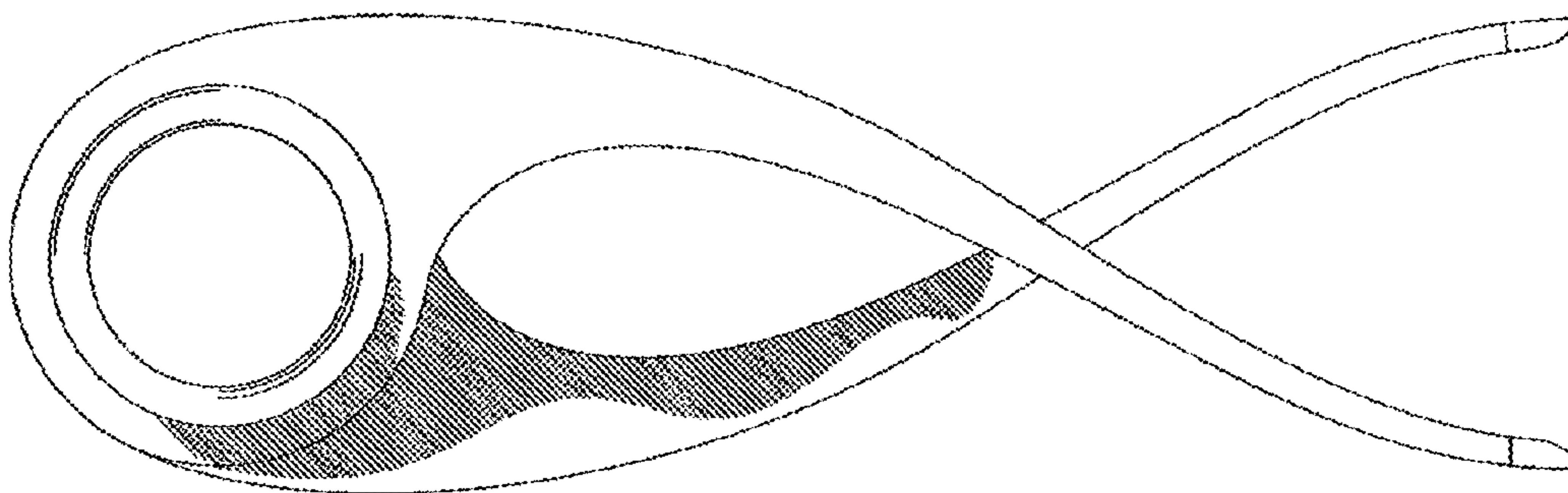

FIGURE 23

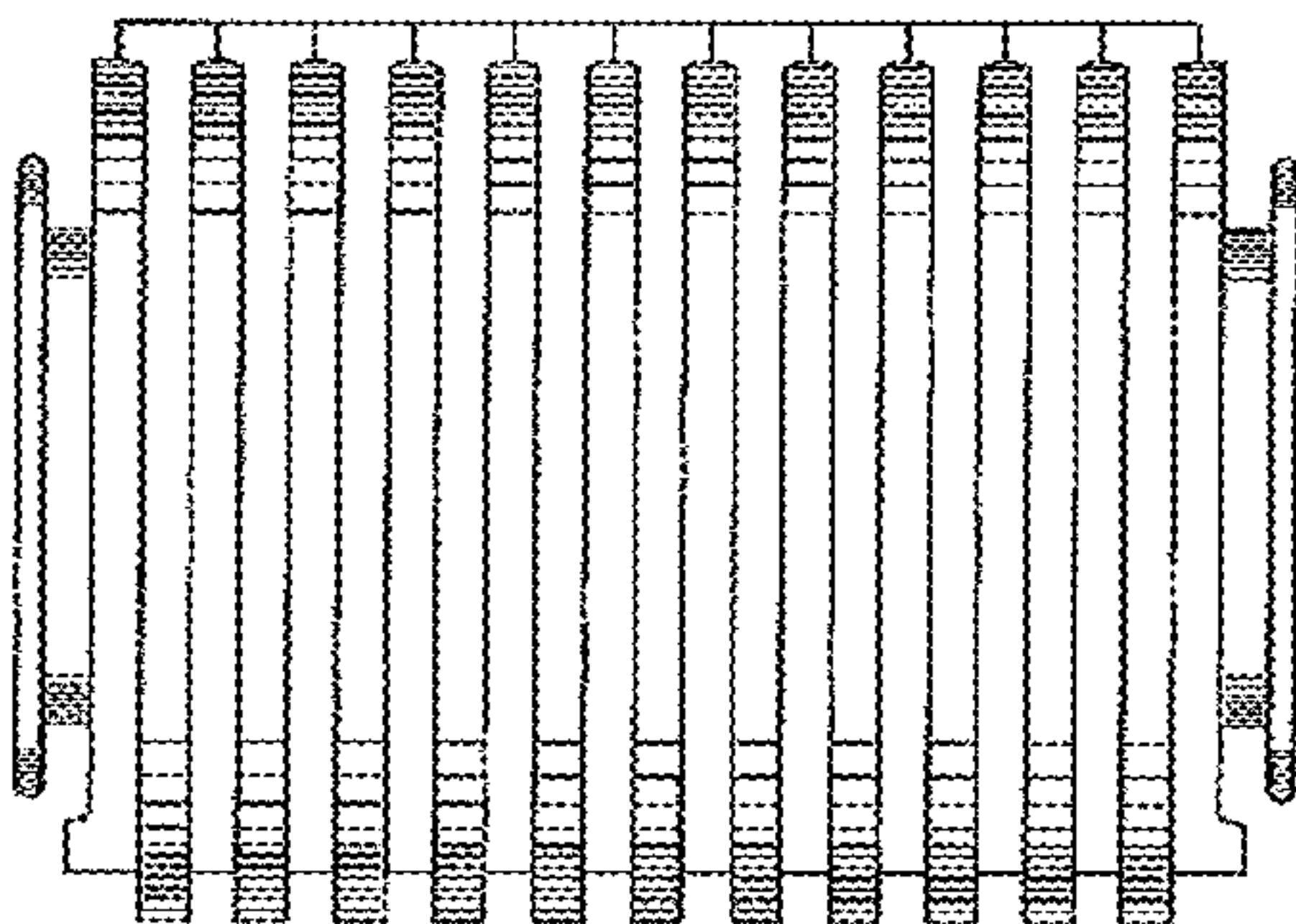

FIGURE 24

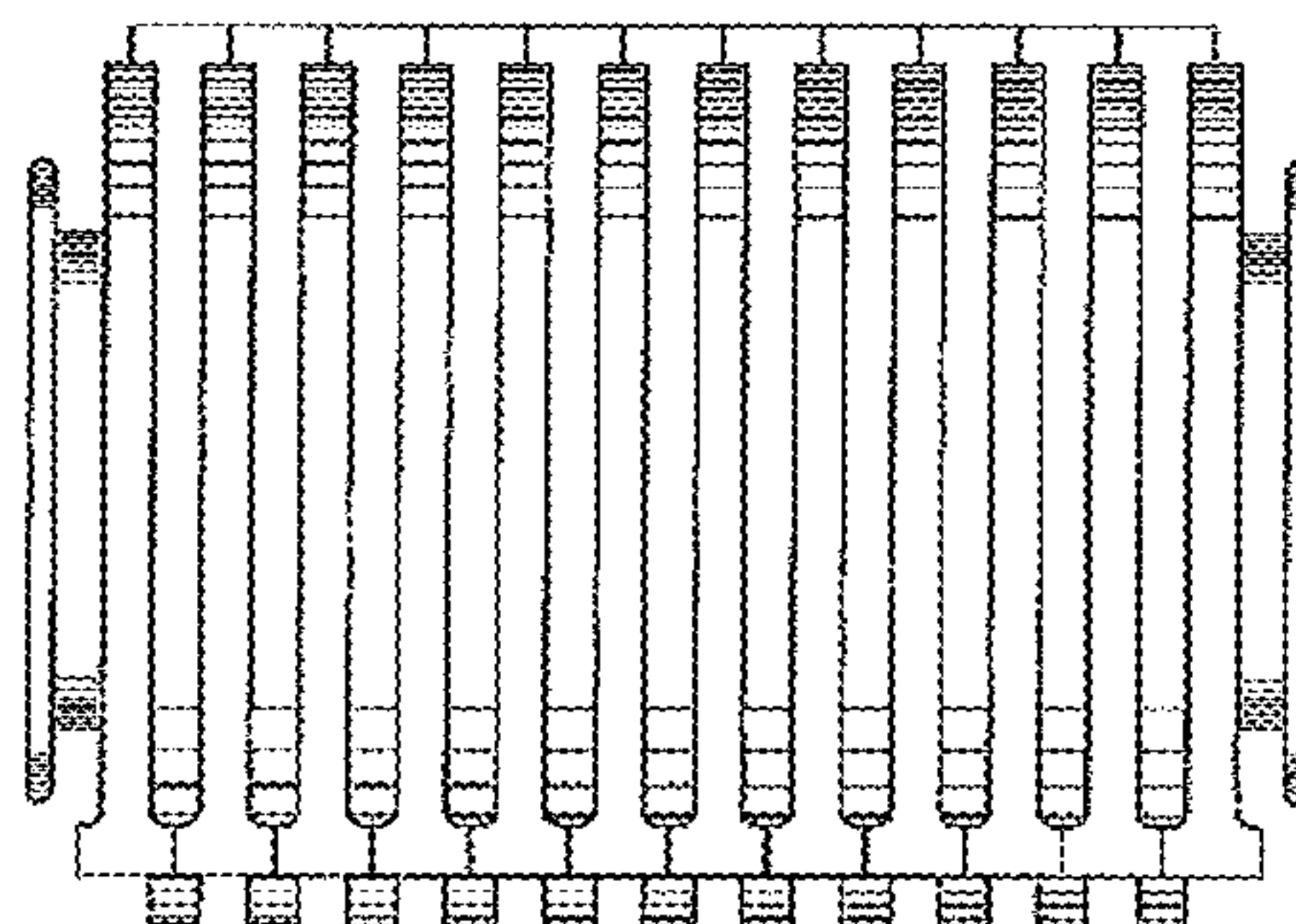



FIGURE 25

