



US00D750910S

(12) **United States Design Patent**
Yassa

(10) **Patent No.:** **US D750,910 S**
(45) **Date of Patent:** **** Mar. 8, 2016**

(54) **SHOWER CHAIR**

(56) **References Cited**

(71) Applicant: **121 Group Management Pty LTD,**
Kellyville (AU)

U.S. PATENT DOCUMENTS

(72) Inventor: **Meray Yassa,** Kellyville (AU)

D329,278 S *	9/1992	Gallup	D23/278
D494,767 S *	8/2004	Self	D6/362
D552,366 S *	10/2007	Graves	D6/367
D602,703 S *	10/2009	Luxton	D6/362
D611,259 S *	3/2010	Yeung	D6/333
D656,226 S *	3/2012	Erli	D23/278
D656,227 S *	3/2012	Erli	D23/278
D660,042 S *	5/2012	Higgs	D6/374
D670,088 S *	11/2012	Wozniak	D6/333
D674,614 S *	1/2013	Morand	D6/333
D688,474 S *	8/2013	Tu	D6/333

(73) Assignee: **121 GROUP MANAGEMENT PTY LTD.,** Kellyville, NSW (AU)

(**) Term: **14 Years**

(21) Appl. No.: **29/502,369**

* cited by examiner

(22) Filed: **Sep. 15, 2014**

Primary Examiner — Caron D Veynar

Assistant Examiner — Abraham Bahta

(74) *Attorney, Agent, or Firm* — Ladas & Parry, LLP

(51) **LOC (10) Cl.** **06-01**

(57) **CLAIM**

(52) **U.S. Cl.**

The ornamental design for a shower chair, as shown and described.

USPC **D6/362; D6/339**

DESCRIPTION

(58) **Field of Classification Search**

USPC D6/333, 335, 339, 716.1–716.4, 716,
D6/362, 364, 390, 379–380; 4/572.1, 586,
4/578.1; D12/129; D21/412, 419;
280/30–31; 5/94, 98.1, 99.1, 101, 102,
5/105, 655; D23/304, 275–278, 273,
D23/280.4; D24/204–205; 297/183–183.4,
297/184.13, 184.15, 184.17, 250.1, 255,
297/256.1, 256.15, 256.16, 183.7, 445.1,
297/452.29, 452.63

CPC A47K 3/122; A47K 3/282; A47C 1/16;
A47C 9/06

FIG. 1 is a perspective view of the shower chair showing my new design;
FIG. 2 is a front perspective view thereof;
FIG. 3 is a side perspective view thereof;
FIG. 4 is a rear perspective view thereof;
FIG. 5 is a top plan view thereof;
FIG. 6 is a bottom view thereof;
FIG. 7 is a side view thereof;
FIG. 8 is another side view thereof;
FIG. 9 is a front view thereof; and,
FIG. 10 is a rear view thereof.

See application file for complete search history.

1 Claim, 7 Drawing Sheets

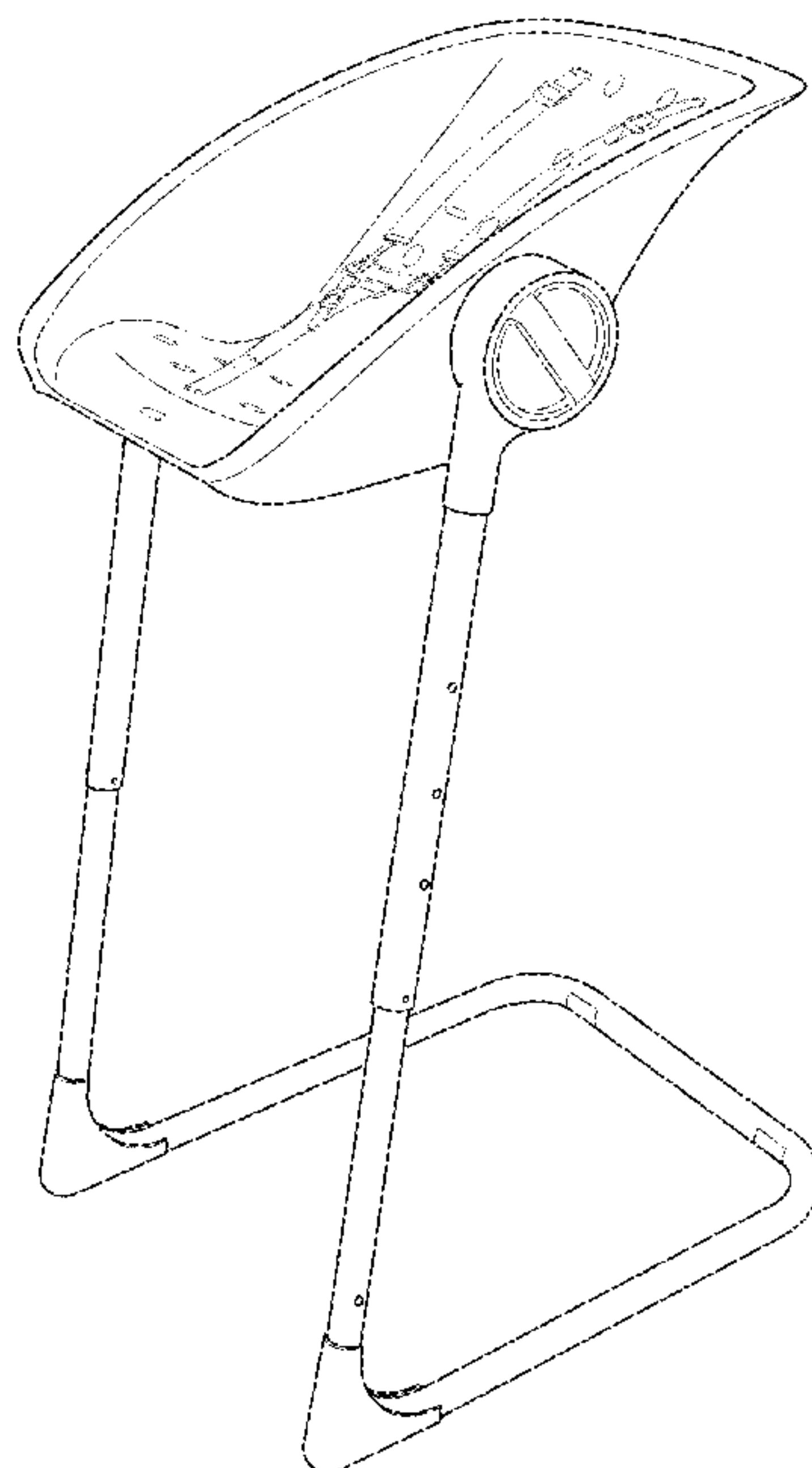

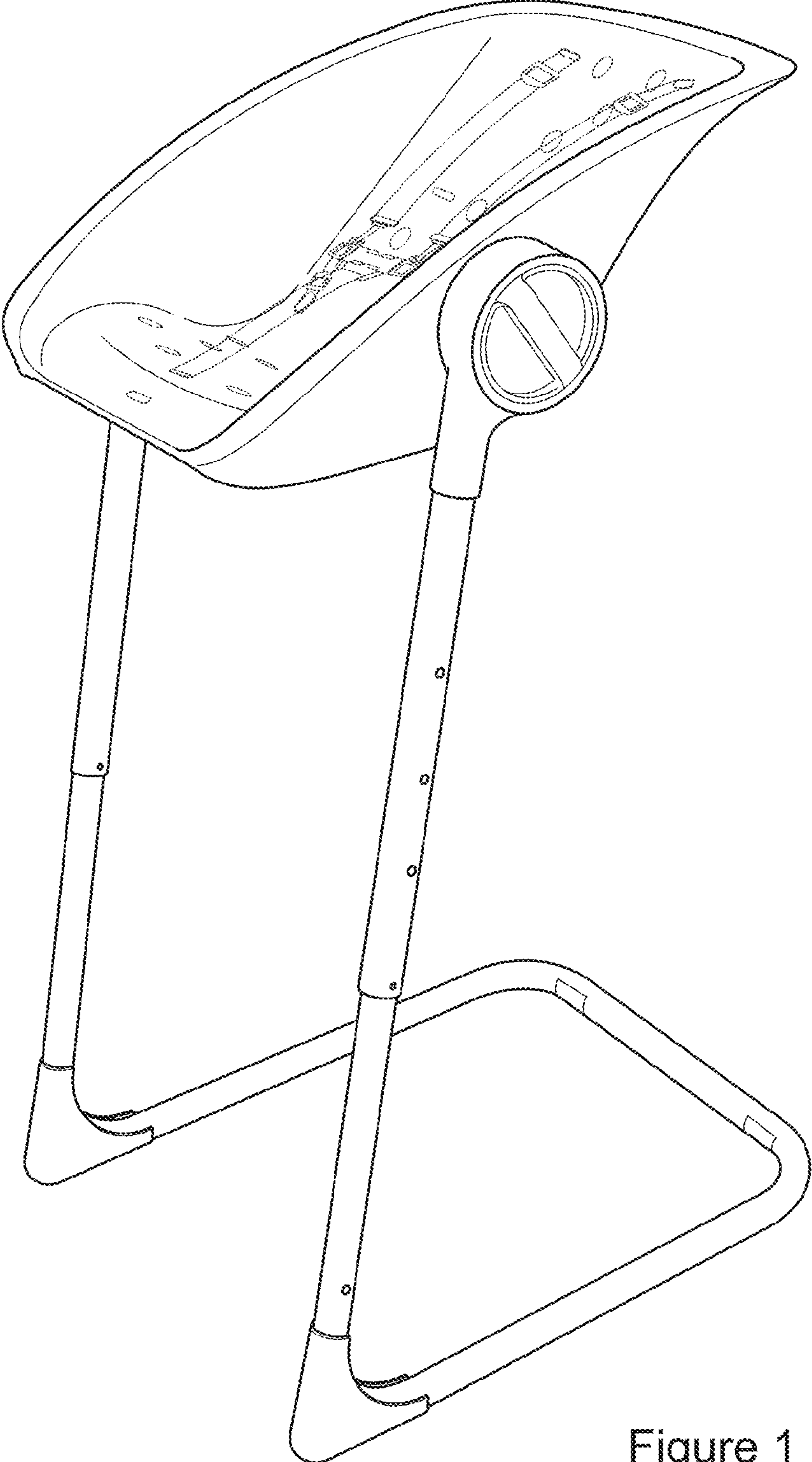

Figure 1

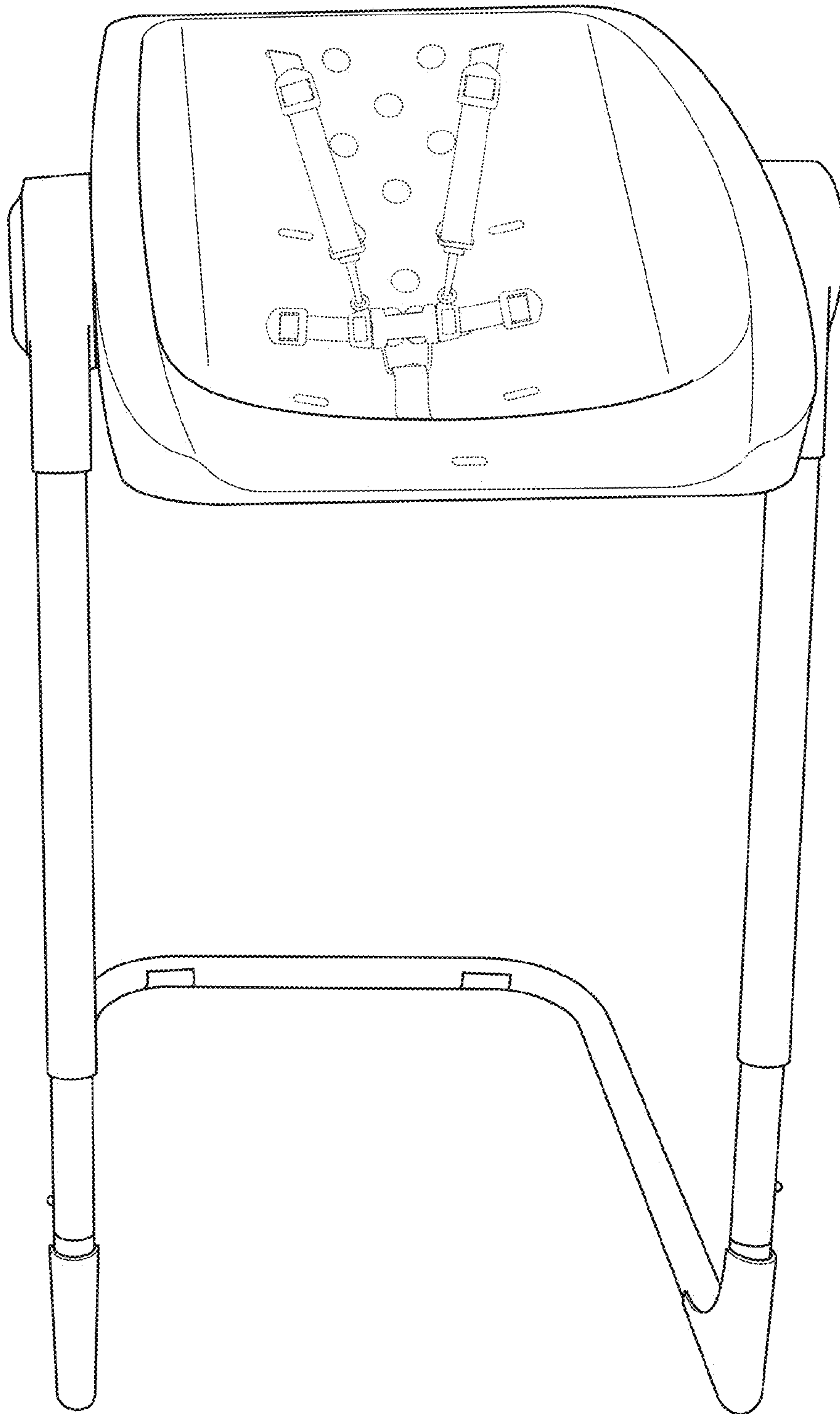

Figure 2

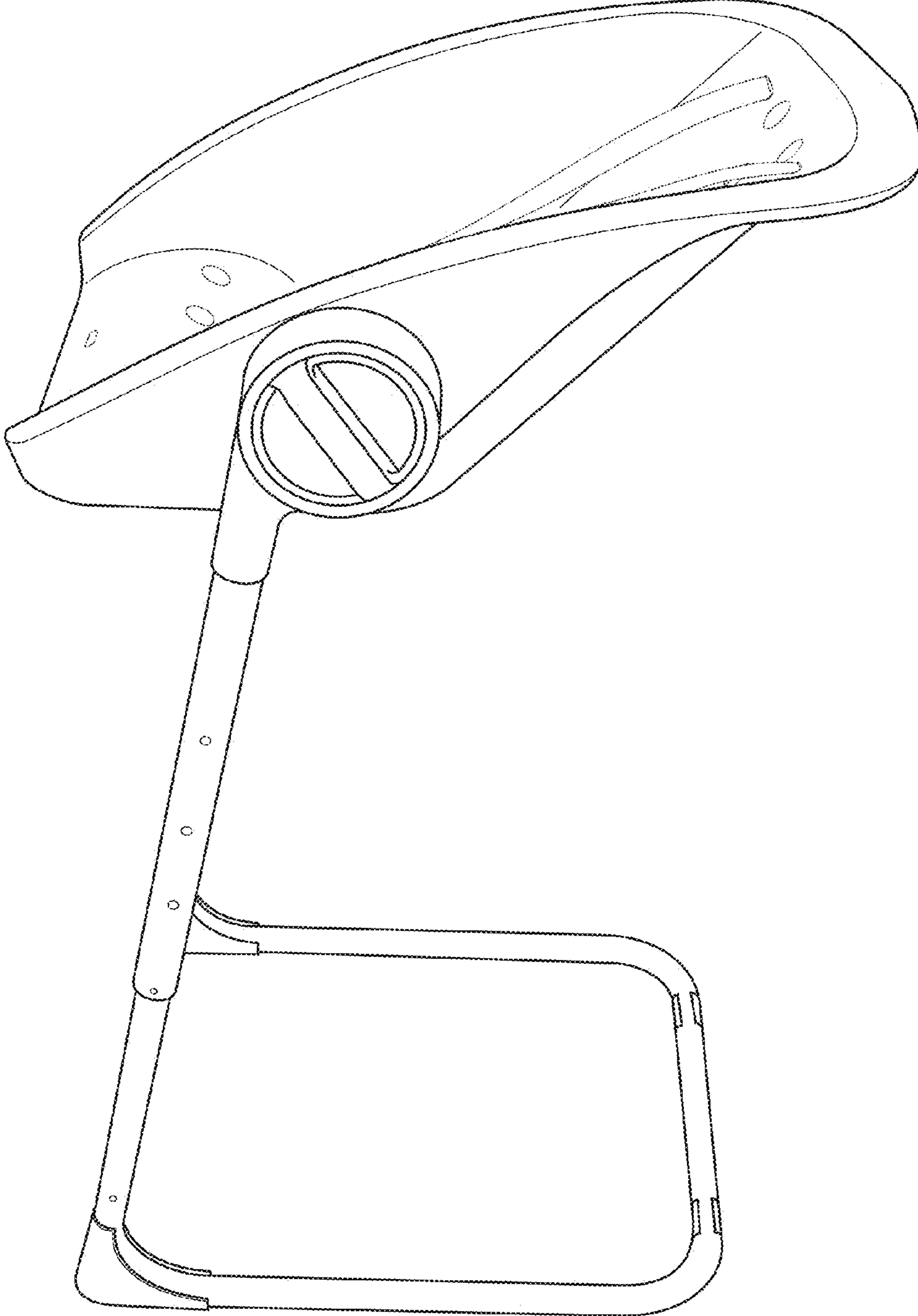

Figure 3

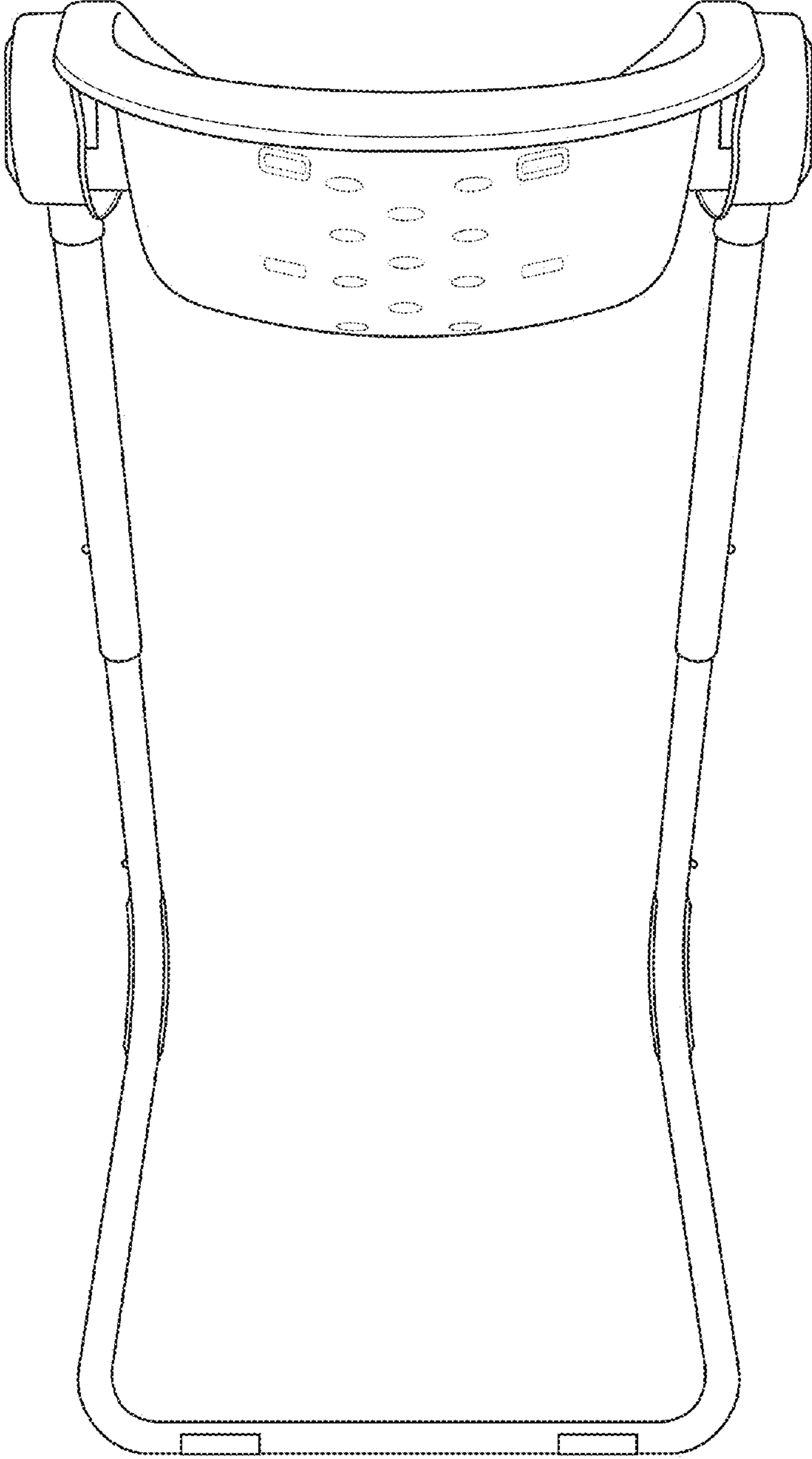

Figure 4

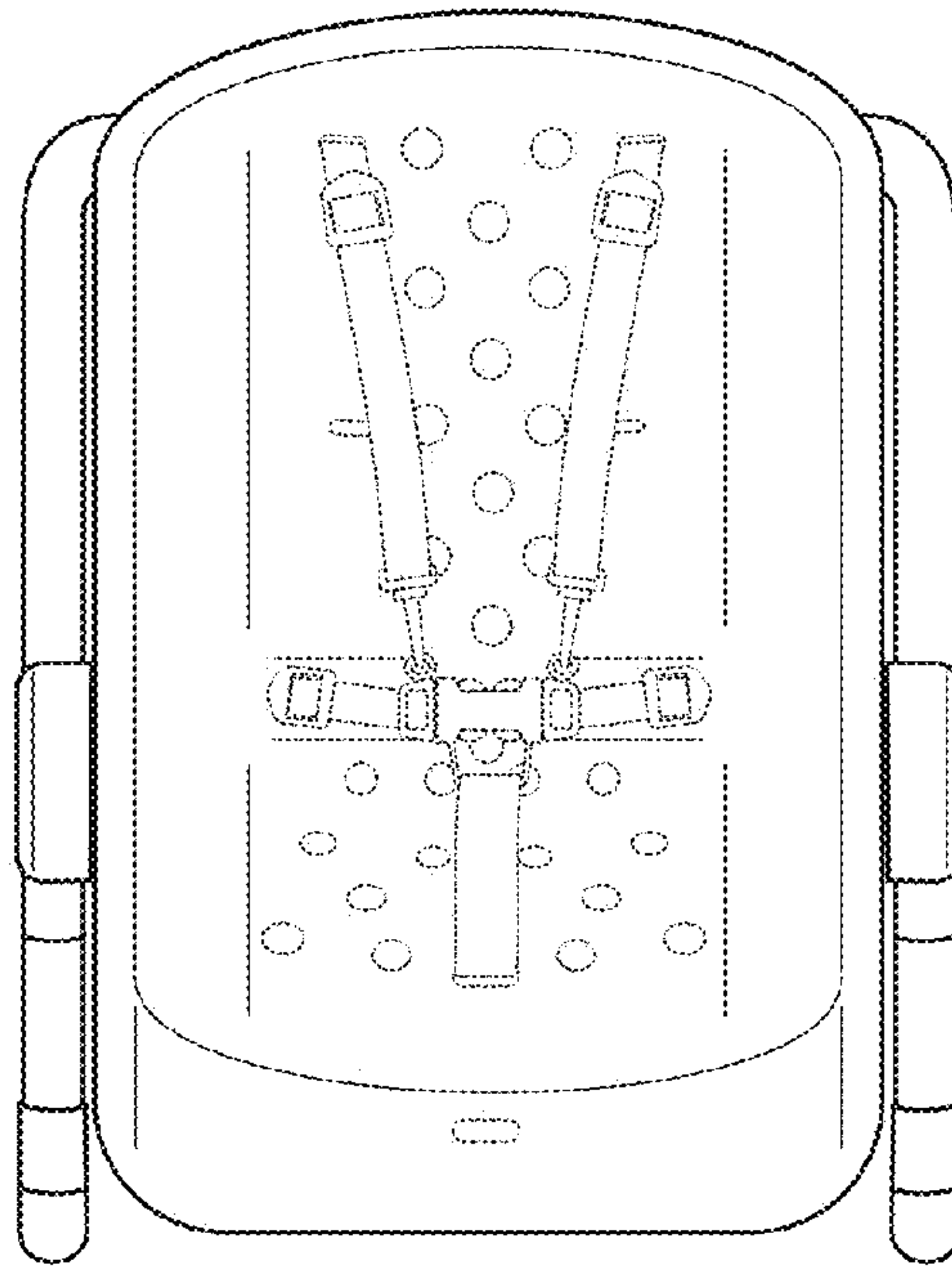

Figure 5

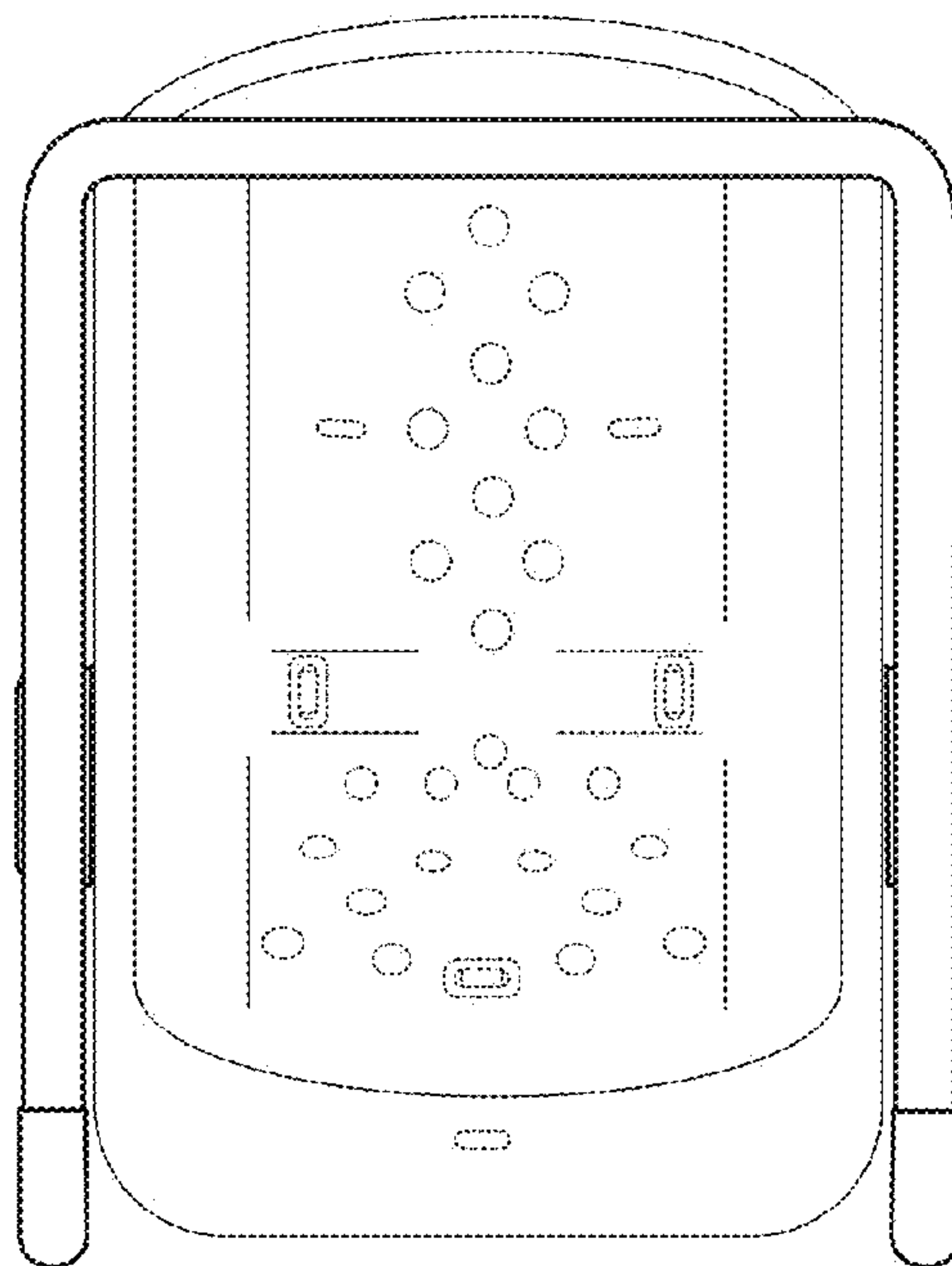

Figure 6

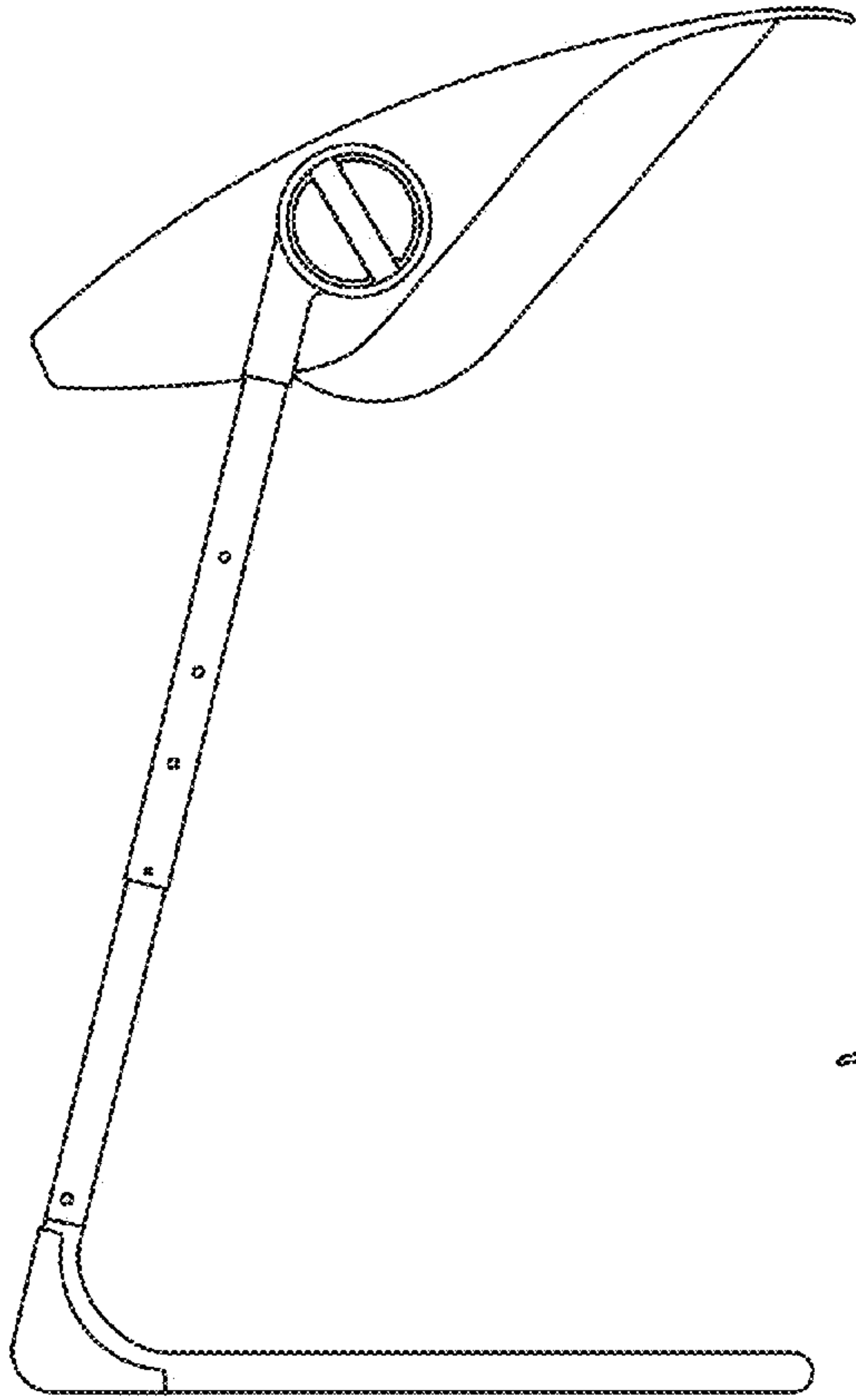

Figure 7

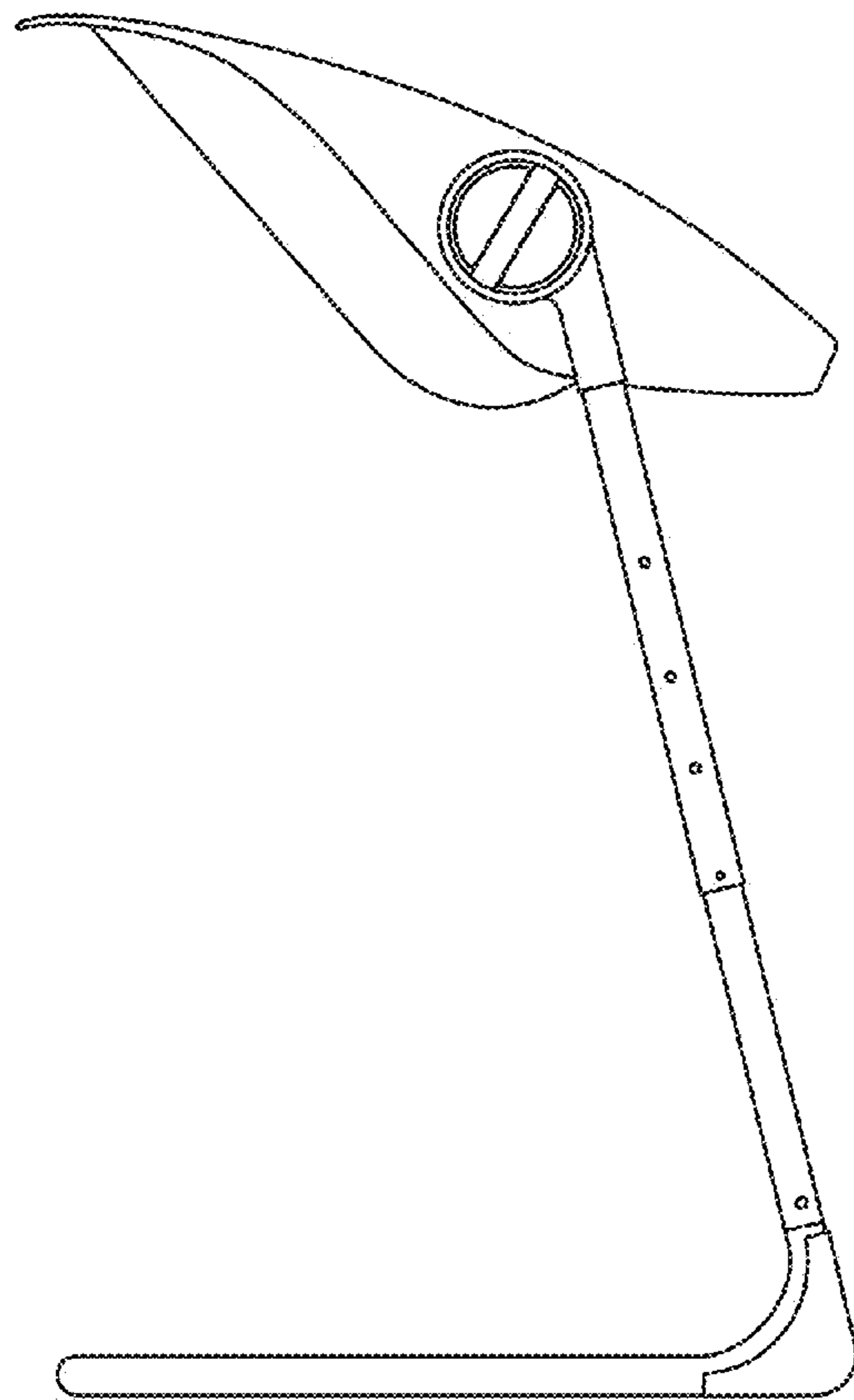

Figure 8

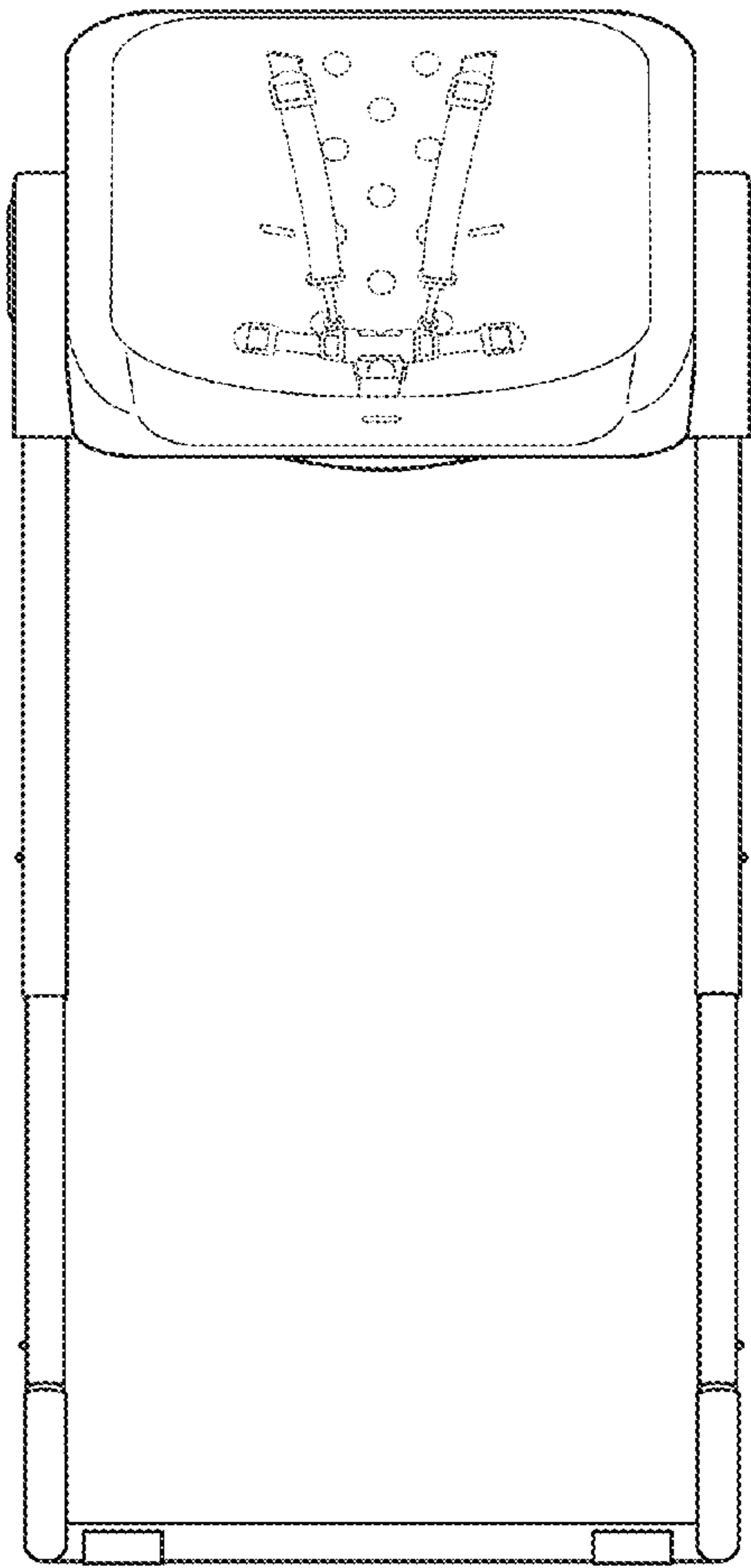

Figure 9

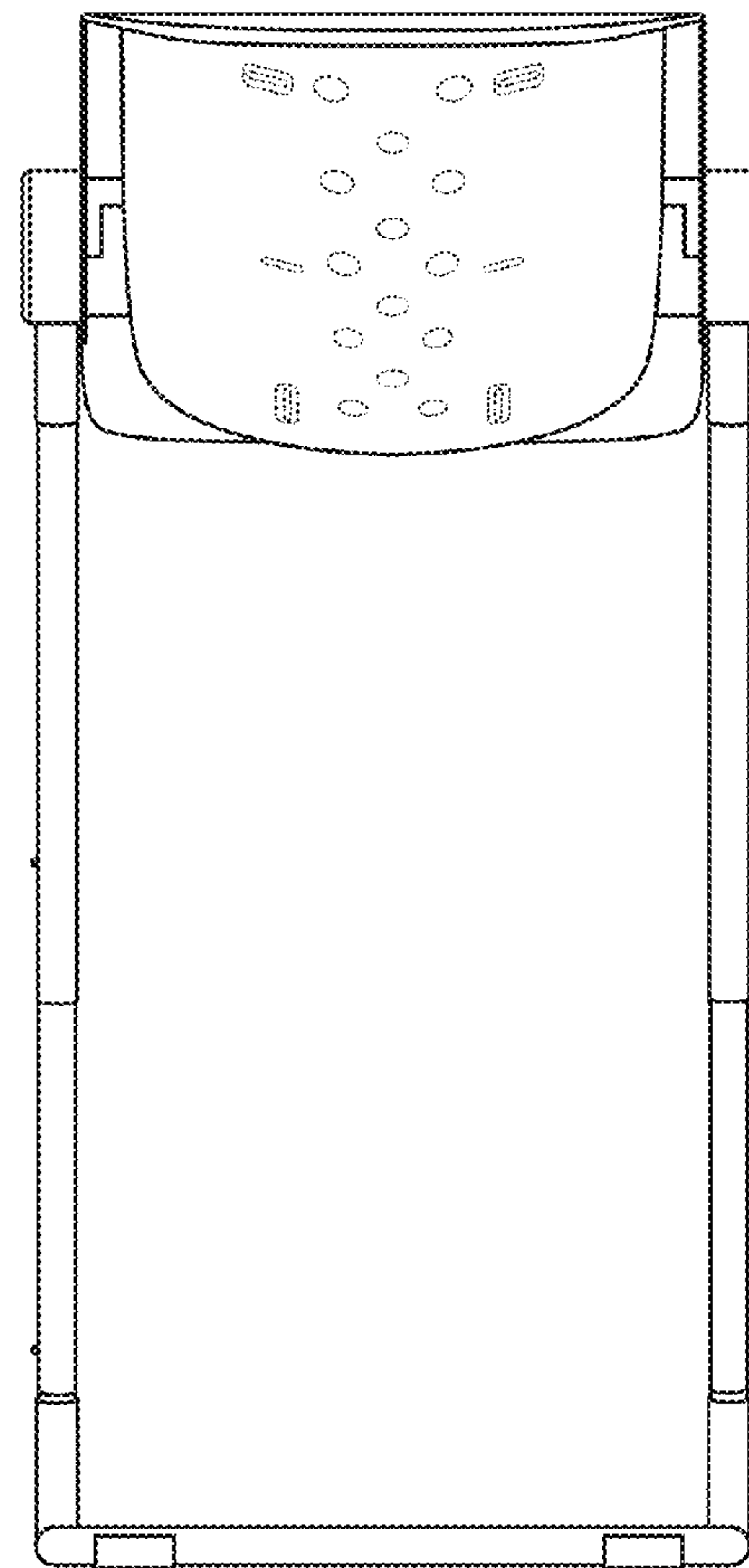

Figure 10