



US00D750872S

(12) **United States Design Patent**
Gavrieli et al.

(10) **Patent No.:** **US D750,872 S**
(45) **Date of Patent:** **** *Mar. 8, 2016**

(54) **SINGLE SOLE SHOE WITH STRIPE,
MIDSOLE, GREEN SOLE, AND
CONTRASTING UPPER**

(71) Applicant: **Gavrieli Brands, LLC**, Beverly Hills,
CA (US)

(72) Inventors: **Kfir Gavrieli**, Los Angeles, CA (US);
Dikla Gavrieli, Los Angeles, CA (US)

(73) Assignee: **Gavrieli Brands LLC**, Beverly Hills,
CA (US)

(*) Notice: This patent is subject to a terminal dis-
claimer.

(**) Term: **14 Years**

(21) Appl. No.: **29/493,519**

(22) Filed: **Jun. 10, 2014**

(51) **LOC (10) Cl.** **02-04**

(52) **U.S. Cl.**
USPC **D2/939**

(58) **Field of Classification Search**
USPC D2/896, 900, 919-921, 925, 939, 947,
D2/950, 969, 971; 36/1, 83, 8.1-8.3, 9 R,
36/45-58, 104, 108, 76 R
CPC A43B 21/00; A43B 21/02; A43B 21/06;
A43B 9/14; A43B 1/0045; A43B 13/10;
A43B 13/12; A43B 23/06; A43B 23/07;
A43B 1/0036

See application file for complete search history.

(56) **References Cited**

U.S. PATENT DOCUMENTS

1,525,848 A * 2/1925 Bonaventure 36/8.3
1,587,377 A 6/1926 Grosjean

(Continued)

FOREIGN PATENT DOCUMENTS

DE 20 2006 000230 U1 5/2007
GB 2 446 205 A 8/2008
TW D119165 10/2007

OTHER PUBLICATIONS

Examination Report for AU 341324, 3 pgs., dated Oct. 24, 2012.

(Continued)

Primary Examiner — Dominic Simone

(74) *Attorney, Agent, or Firm* — Morgan, Lewis & Bockius
LLP

(57) **CLAIM**

The ornamental design for a single-sole shoe with stripe,
midsole, green sole, and contrasting upper, as shown and
described.

DESCRIPTION

The file of this patent contains at least one drawing executed
in color. Copies of this patent with color drawing(s) will be
provided by the Office upon request and payment of the
necessary fee.

FIG. 1 is a perspective view of our new design for a single-
sole shoe with stripe, midsole, green sole, and contrasting
upper, where the portions of the upper that contrast with the
sole are indicated by cross-hatch shading;

FIG. 2 is a first side view thereof;

FIG. 3 is a second side view thereof;

FIG. 4 is a top view thereof;

FIG. 5 is a bottom view thereof;

FIG. 6 is a front view thereof;

FIG. 7 is a back view thereof;

FIG. 8 is a perspective view of another embodiment of our
new design of a single-sole shoe with stripe, midsole, green
sole, and contrasting upper of FIG. 1, where the green por-
tions are indicated using the USPTO convention of solid
diagonal lines extending from the upper left to the lower right
for green, and where the portions of the upper that contrast
with the sole are indicated by cross-hatch shading;

FIG. 9 is a first side view thereof;

FIG. 10 is a second side view thereof;

FIG. 11 is a top view thereof;

FIG. 12 is a bottom view thereof;

FIG. 13 is a front view thereof; and,

FIG. 14 is a back view thereof.

The broken lines illustrating the channel on the green sole in
the above described Figures are for illustrative purposes only
and form no part of the claimed design.

1 Claim, 12 Drawing Sheets
(5 of 12 Drawing Sheet(s) Filed in Color)

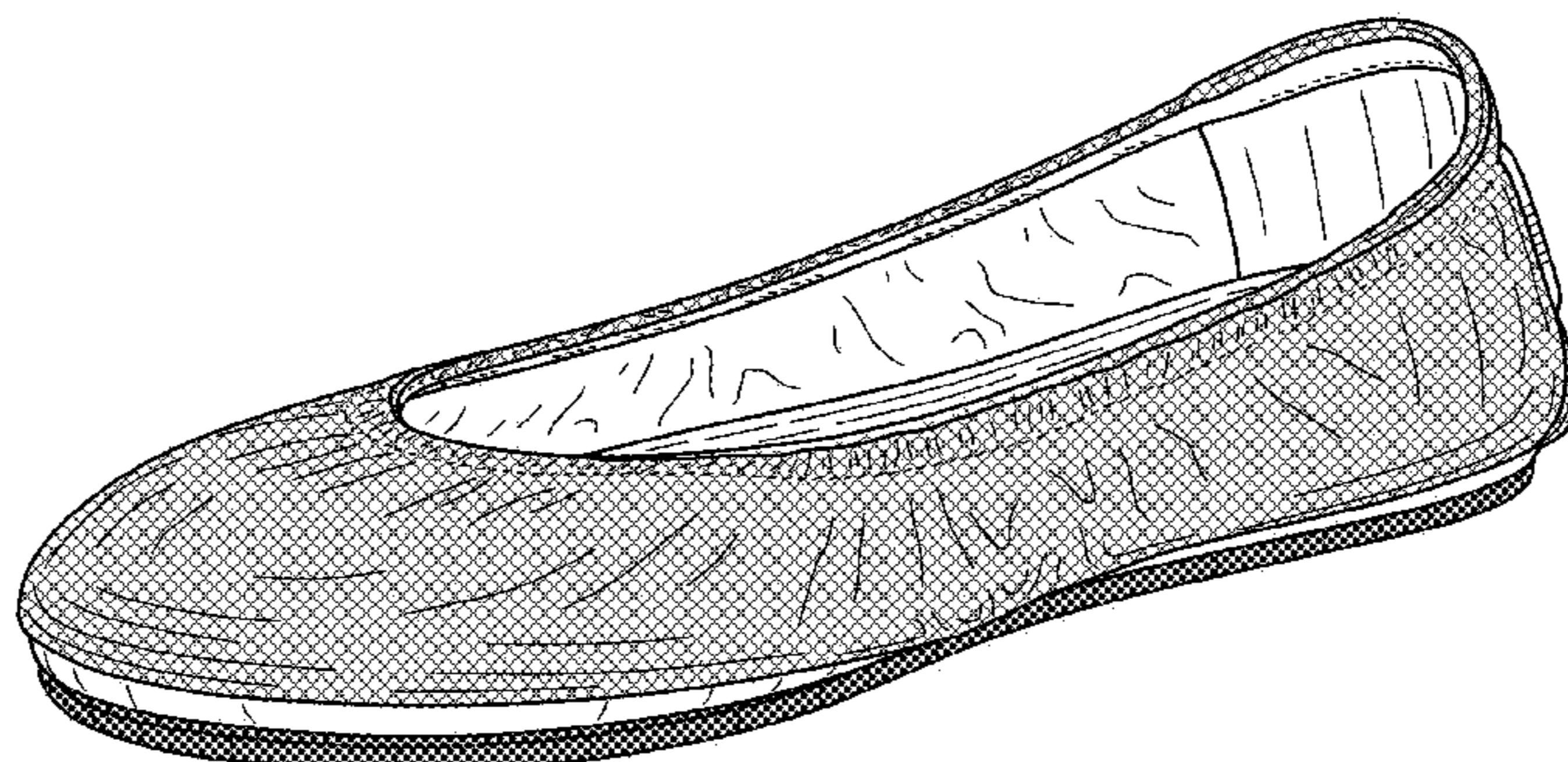

(56)

References Cited

U.S. PATENT DOCUMENTS

1,650,466 A 11/1927 Righter
 2,268,777 A 1/1942 Scholl
 D133,819 S * 9/1942 Harris D2/939
 D149,685 S * 5/1948 Sandler D2/935
 D150,729 S * 8/1948 Sandler D2/927
 D166,090 S * 3/1952 Maling D2/897
 2,904,814 A 9/1959 Scholl
 3,148,378 A 9/1964 Tibbitts
 D200,897 S * 4/1965 Mitchell D2/919
 D247,396 S * 3/1978 Schlerth D2/939
 4,412,393 A 11/1983 Terlizzi, Jr. et al.
 D295,692 S * 5/1988 Zuidema et al. D2/950
 D300,085 S 3/1989 Ito et al.
 RE33,018 E 8/1989 Ostrander
 4,899,412 A 2/1990 Ganon
 D316,773 S 5/1991 Valle
 5,012,541 A 5/1991 Ganon
 D339,669 S * 9/1993 Miller D2/919
 5,282,326 A 2/1994 Schroer, Jr. et al.
 5,421,050 A 6/1995 Laganas
 5,699,629 A 12/1997 Munsch
 5,746,014 A 5/1998 Tanemoto
 6,055,745 A 5/2000 Endoh
 6,076,284 A 6/2000 Terlizzi
 6,189,239 B1 2/2001 Gasparovic et al.
 6,338,207 B1 1/2002 Chang
 D457,292 S * 5/2002 Sessa D2/949
 D461,947 S 8/2002 Merceron
 D476,798 S 7/2003 Reynolds et al.
 6,588,124 B2 7/2003 Morrone
 D498,041 S 11/2004 McClaskie
 D500,191 S * 12/2004 Belley et al. D2/969
 D501,706 S 2/2005 McClaskie
 6,857,203 B2 2/2005 Minden
 6,895,693 B2 5/2005 Baruck
 6,978,557 B2 12/2005 Lee
 7,032,327 B1 4/2006 Tartaglia et al.
 7,036,244 B1 5/2006 Finch
 D527,513 S * 9/2006 Della Valle D2/919
 D531,790 S 11/2006 Wurzburg
 D534,341 S * 1/2007 Choi D2/971
 D542,513 S 5/2007 Amado et al.
 7,337,558 B2 3/2008 Terlizzi et al.
 D570,488 S 6/2008 Kirksey et al.
 D571,548 S 6/2008 Seamans
 D571,989 S 7/2008 Siegal
 D580,640 S 11/2008 Wurzburg
 D582,638 S 12/2008 Ringholz
 7,496,982 B2 3/2009 Clark et al.
 7,506,459 B2 3/2009 Grisoni et al.
 D591,031 S 4/2009 Cofinco
 D593,295 S * 6/2009 Belley et al. D2/969
 D593,297 S * 6/2009 Belley et al. D2/969
 D593,307 S * 6/2009 Belley et al. D2/969
 D599,093 S * 9/2009 Issler D2/971
 D604,030 S 11/2009 Wilson
 D607,194 S 1/2010 Zagula
 D610,332 S 2/2010 Raichle
 D610,785 S 3/2010 Smith
 D612,140 S 3/2010 Moon
 D612,141 S 3/2010 Moon
 7,694,435 B1 4/2010 Kiser et al.
 7,735,244 B1 6/2010 Ameche
 7,743,530 B2 6/2010 Truelsen
 7,757,408 B2 7/2010 McClaskie
 D632,881 S 2/2011 Rosenberg
 7,926,203 B2 4/2011 Wilkenfeld
 7,966,747 B2 6/2011 Wilkenfeld et al.
 D640,861 S 7/2011 Wilkenfeld
 8,020,320 B2 9/2011 Gillespie
 8,127,468 B2 3/2012 Morgan
 D664,755 S 8/2012 Gavrieli et al.
 8,240,067 B2 8/2012 Sussmann
 8,245,420 B2 8/2012 Wilson
 D668,027 S 10/2012 Millieret

D668,438 S 10/2012 Millieret
 D668,847 S 10/2012 Gavrieli et al.
 D668,848 S 10/2012 Gavrieli et al.
 D672,542 S 12/2012 Gray et al.
 D676,634 S 2/2013 Gavrieli et al.
 8,468,723 B2 6/2013 Malka-Harari
 8,510,975 B2 8/2013 Krikelis
 8,661,714 B2 3/2014 Sussmann
 2002/0078591 A1 6/2002 Morrone
 2002/0129519 A1 9/2002 Cahan
 2003/0070319 A1 4/2003 Minden
 2004/0025377 A1 2/2004 Brannon
 2005/0022421 A1 2/2005 Bruckner
 2005/0115115 A1 6/2005 Lacey
 2005/0217148 A1 10/2005 Connolly et al.
 2006/0086005 A1 4/2006 Yerian
 2006/0156576 A1 7/2006 Sloan
 2007/0204482 A1 9/2007 Gibson-Collinson
 2007/0204483 A1 9/2007 Kirsch et al.
 2008/0052964 A1 3/2008 Taylor
 2008/0110059 A1 5/2008 Kuramoto et al.
 2009/0019732 A1 1/2009 Sussmann
 2009/0272009 A1 11/2009 Weisner et al.
 2010/0018080 A1 1/2010 Smith
 2010/0095557 A1 4/2010 Jarvis
 2010/0115793 A1 5/2010 Kraisosky
 2010/0146822 A1 6/2010 MacGregor
 2010/0281713 A1 11/2010 Pantazes

OTHER PUBLICATIONS

Letter from TMI and Associates with Office Action, 2 pgs, dated Sep. 19, 2012 <http://www.payless.com/store/?&TLC=Womens&SLC=WomensNewArrivals&BLC=WomensNewArrivalsNewArrivals&With+Regular&ItemCode=60131&LotNumber=062642&Type=Adult&Popularity=637&Descriptvein>.
 Taiwanese Office Action for TW 101300726, 10 pgs., dated Sep. 6, 2012.
 “The Love List, Tieks by Gavrieli—Foldable Ballet Flats,” <http://thelovelist-carly.blogspot.com.au/2010/09/tieks-by-gavrieli-foldable-ballet.html>, 3 pgs., Sep. 12, 2010.
 “Tieks by Gavrieli,” <http://tieks.com>, 1 pg., retrieved Mar. 13, 2013 from URL.
 “Try It Mummy!, Tieks by Gavrieli,” <http://tryitmummy.blogspot.com.au/2010/12/tieks-by-gavrieli.html>, 4 pgs., Dec. 9, 2010.
 “Wearability—Real People Style, What came first, the City Flat or the Tieks,” <http://wearability.posterous.com/what-came-first-the-city-flat-or-the-tieks>, 4 pgs., Aug. 29, 2010.
 “The Ballet Flat . . . Reinvented; Ballet Flats . . . with a Bonus; Step Into Tieks; Going Places? Take Tieks,” <http://web.archive.org/web/2010052004346/http://www.tieks.com/>; 4 pgs., May 24, 2010.
 “Tieks—Comfortable designer flats you can fit in your purse and wear all day, every day,” <http://web.archive.org/web/20110731151555/http://tieks.com/>; 6 pgs., Jul. 31, 2011.
 “58th Annual Emmy Awards,” http://spoonsforksandfashion.blogspot.com/2006_08_01_archive.html, depicting Nine West flats, 11 pgs., Aug. 1, 2006.
 Pictures of Nine West flats sold in 2006, 3 pgs.
 “I Love a Good Ballet Flat!,” <http://dressupfiles.com/i-love-a-good-ballet-flat>, depicting Sue London flats, 4 pgs., Sep. 3, 2010.
 Pictures of Sue London flats sold in 2010, 2 pgs.
 “Miss Cathie Reviews: The Yosi Samra Foldable Ballet Flat . . .,” <http://www.misscathie.com/2010/01/miss-cathie-reviews-the-yosi-samra-foldable-ballet-flat/>, depicting Yosi Samra flats, 7 pgs., Jan. 2010.
 Pictures of Yosi Samra flats sold in 2010, 2 pgs.
 “Goodbye two thousand ten,” http://emmajoyrussell.blogspot.com/2010_12_01_archive.html, depicting Gap flats, 39 pgs., Dec. 1, 2010.
 Pictures of Gap flats available for sale in 2010, 9 pgs.
 “Our newest design of folding flats—Pink,” <https://fitinclouds.wordpress.com/2010/05/16/our-newest-design-of-folding-flats-pink/>, depicting Fit in Clouds flats, 1 pg., May 16, 2010.

(56)

References Cited

OTHER PUBLICATIONS

“Fit in Clouds Satin Folding Shoes,” <http://www.goodhousekeeping.com/product-reviews/clothing/best-ballet-flats/fit-in-clouds-satin-foldable-ballet-flats>, depicting Fit in Clouds flats, 1 pg., Aug. 2013. Pictures of Fit in Clouds flats available for sale in 2011, 4 pgs.

“Shoes for Standing,” <https://truthinshoes.wordpress.com/2008/07/>, depicting Sam & Libby flats, 2 pgs., Jul. 31, 2008.

“Target Designer Collaboration: Announcing Sam & Libby Shoes for Target,” <http://www.therecessionista.com/2012/11/target-designer-collaboration-announcing-sam-libby-shoes-for-target.html>, depicting Sam & Libby flats, 1 pg., Nov. 26, 2012. Pictures of Sam & Libby flats available for purchase in 2011, 5 pgs.

“Save your soles with Citisoles ballet flats,” <http://glamazondiaries.com/2009/07/save-your-soles-with-citisoles-ballet-flats>, depicting Citisoles flats, 3 pgs., Jul. 2009. Pictures of Citisoles flats available for purchase in 2009, 3 pgs.

“#16 Corso Como Delicious Pumps Review and Giveaway!,” <http://www.mommatoldmeblog.com/2011/01/16-corso-como-delicious-pumps-review.html>, depicting Corso Como flats, 8 pgs., Jan. 16, 2011. Pictures of Corso Como flats available for sale in 2011, 3 pgs.

“jil-sander-navy-lead-ballet-flats-product . . .,” www.ebay.com, depicting Jil Sander flats, 4 pgs., Nov. 2013. Pictures of Jil Sander flats available for sale in 2011, 3 pgs.

“Spare Soles: Shoes That Roll-up & Fold-up,” <http://herpackinglist.com/2011/01/spare-soles-shoes/>, depicting Spare Soles flats, 2 pgs., Jan. 2011. Pictures of Spare Soles flats available for sale in 2011, 5 pgs.

The Original Rollable, Foldable ballet flats with matching wristlet—Spare Soles, <http://herpackinglist.com/2011/01/spare-soles-shoes/>, depicting Roll-Upz Spare Soles flats, 2 pgs., Jan. 2011. Pictures of Roll-Upz by Spare Soles flats available for sale in 2011, 6 pgs.

“The Cutest Blog, Preppy 50 and Loving Lilly, Ballet Flat Delight,” <http://preppy50andlovinglilly.blogspot.com/2011/02/ballet-flat-delight.html>, depicting Henri Bendel flats, 13 pgs., Feb. 19, 2011. Pictures of Henri Bendel flats available for sale in 2011, 4 pgs.

“Mumsnet by parents for parents,” http://www.mumsnet.com/Talk/style_and_beauty/a1612000-Anyone-tried-Redfoot-Flatmates-foldable-ballet-pumps, depicting Redfoot Flatmates flats, 1 pg, Nov. 14, 2012. Pictures of Redfoot Flatmates flats available for sale in 2011, 6 pgs.

“Amazon.com: Customer Reviews: Bloch London Women’s Lux Ballet Flat,” <http://www.amazon.com/Bloch-London-Womens-Ballet-Flat/product-reviews/B004LWP7YW>, depicting Bloch London flats, 4 pgs., Dec. 11, 2011. Pictures of Bloch London flats offered for sale in 2011, 11 pgs.

“h&m foldable leopard print flat,” <http://845shops.wordpress.com/2011/06/16/flats-for-7-bucks/shoe1/>, depicting h&m flats, 3 pgs., Jun. 16, 2011. Pictures of h&m foldable flats offered for sale in 2011, 4 pgs.

“Seekyt—Juicy Couture Ballet Flats—Are They Worth The Money?,” <http://seekyt.com/juicy-couture-ballet-flats-are-they-worth-the-money/>, 14 pgs., Jun. 3, 2011. Pictures of Juicy Couture flats offered for sale in 2011, 3 pgs.

“Purse Flats,” <http://purse-flats.wordpress.com>, depicting Purse Flats by Erica Wilson, 3 pgs., Jul. 12, 2012. Pictures of Purse Flats by Erica Wilson offered for sale in 2011, 6 pgs.

“Splash Page,” <http://web.archive.org/web/2010524004346/http://www.tieks.com/>, 4 pgs., May 24, 2010. “Tieks—Comfortable, designer flats you can fit in your purse and wear all day, every day,” <http://web.archive.org/web/20110731151555/http://tieks.com>, 6 pgs., Jul. 31, 2011. “Tieks by Gavrieli—Comfortable, designer flats you can fit in your purse and wear all day . . .,” <http://web.archive.org/web/20110202210649/http://www.tieks.com/>, 8 pgs., Feb. 2, 2011. “Carolina M. M. Goncalves > Tieks by Gavrieli,” http://m2.facebook.com/Tieks?v=timeline&filter=2&timecutoff=1406427986&page=17§ionLoadingID=m_timeline_loading_div_1293868799_1262332800_8_17&timeend=1293868799×tart=1262332800&tm=AQDOvqhWQPN_Nbwm&refid=17, 1 pg, Jan. 26, 2010. “The Shoes Oprah Would Wear to Work (if She Had to Walk),” <http://www.inc.com/30under30/christina-desmarais/kfir-gavrieli-and-elram-gavrieli-founders-of-tieks.html>, 8 pgs., Jul. 2, 2012. “Tieks by Gavrieli,” http://m2.facebook.com/Tieks?v=timeline&filter=2&timecutoff=1406427986&page=14§ionLoadingID=m_timeline_loading_div_1293868799_1262332800_8_14&timeend=1293868799×tart=1262332800&tm=AQDOvqhWQPN_Nbwm&refid=17, 4 pgs., Jan. 26, 2010. “Mighty Life List, Sensible Shoes,” <http://mightygirl.com/2010/08/24/sensible-shoes/>, 10 pgs., Aug. 24, 2010. “Find! Tieks: Fab & sexy flats for fall,” <http://thefabmom.com/2013/08/29/find-tieks-fab-sexy-flats-for-fall/>, 3 pgs. Aug. 29, 2013. “Step into Tieks,” <http://sliceofpink.typepad.com/blog/2010/09/tieks-1.html>, 5 pgs., Sep. 22, 2010. “In Need of Flat-Soled Shoes,” <http://sliceofpink.typepad.com/blog/2010/09/tieks.1.html>, 7 pgs., Oct. 3, 2010.

* cited by examiner

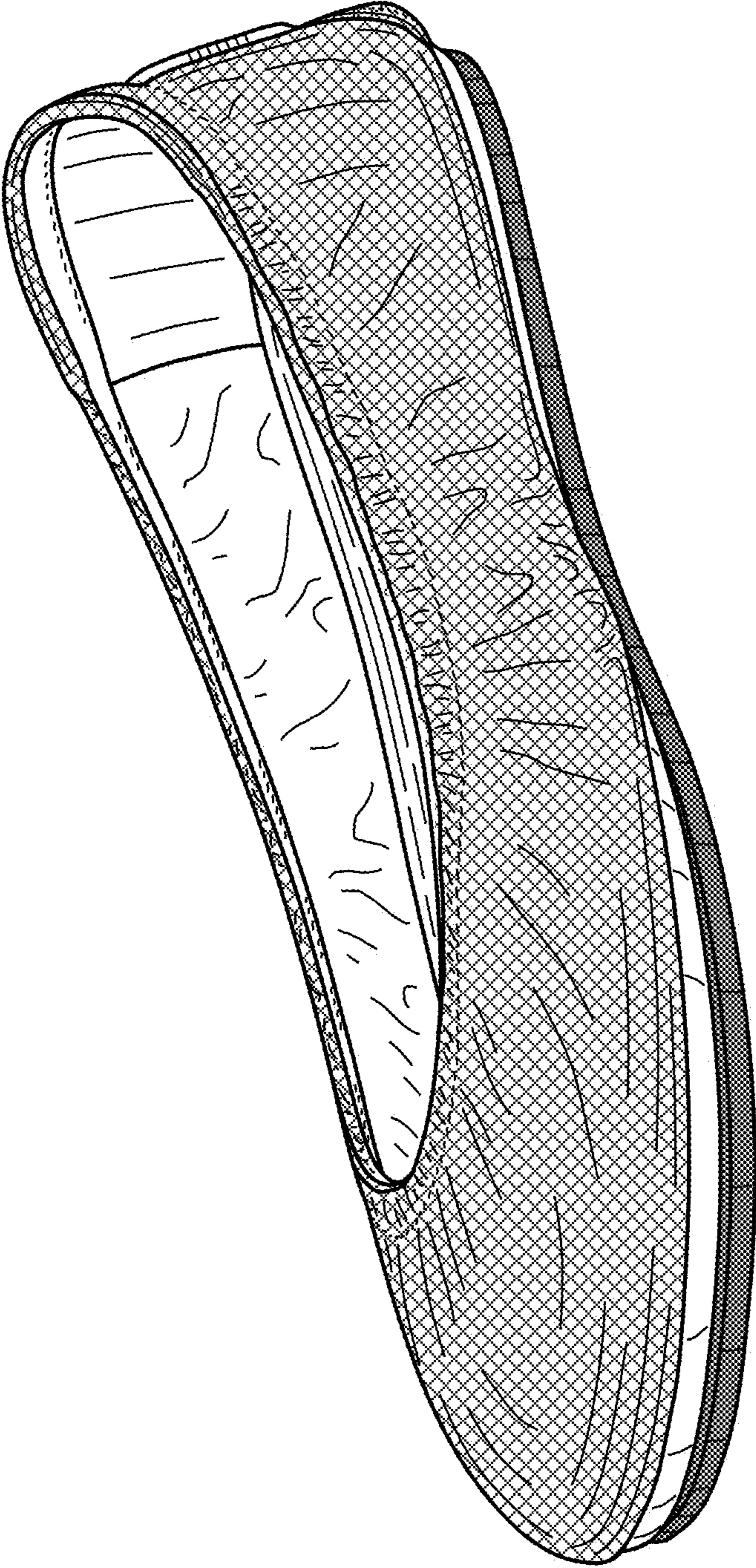

FIG. 1

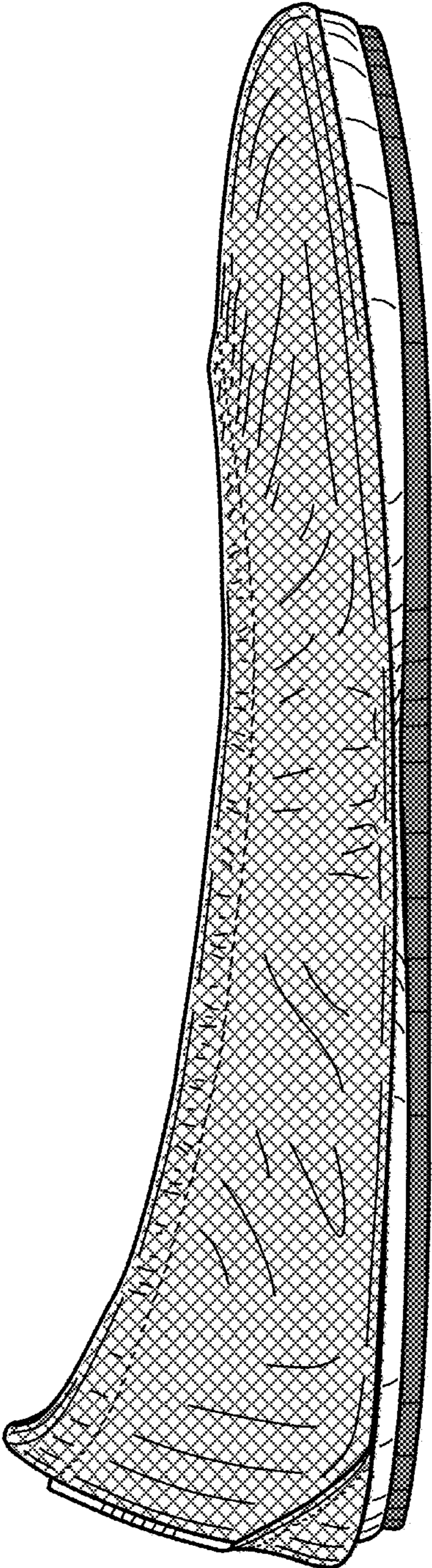

FIG. 2

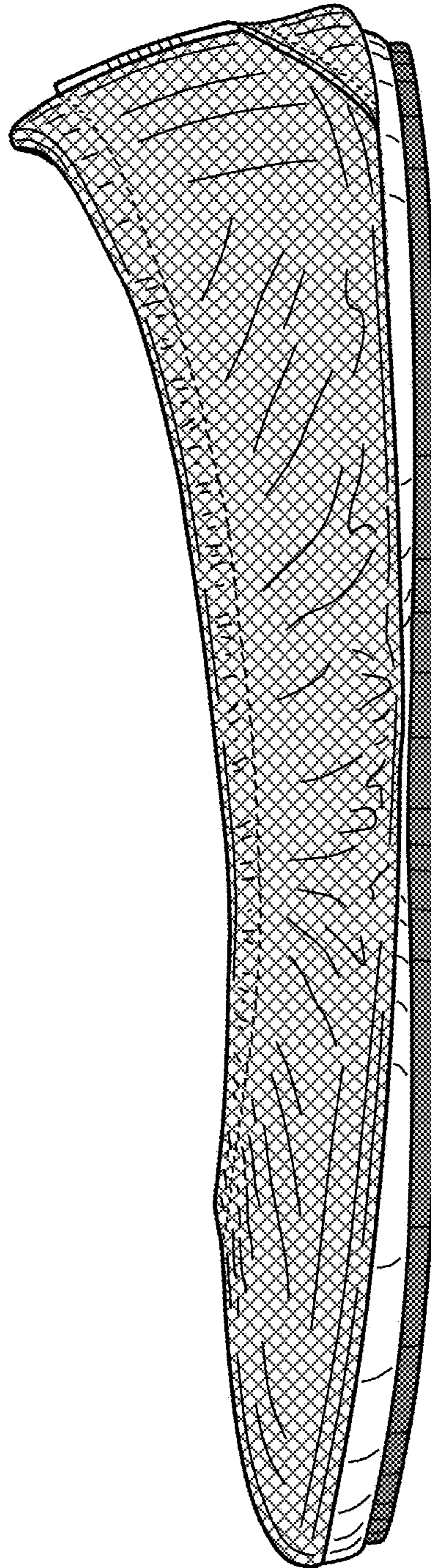

FIG. 3

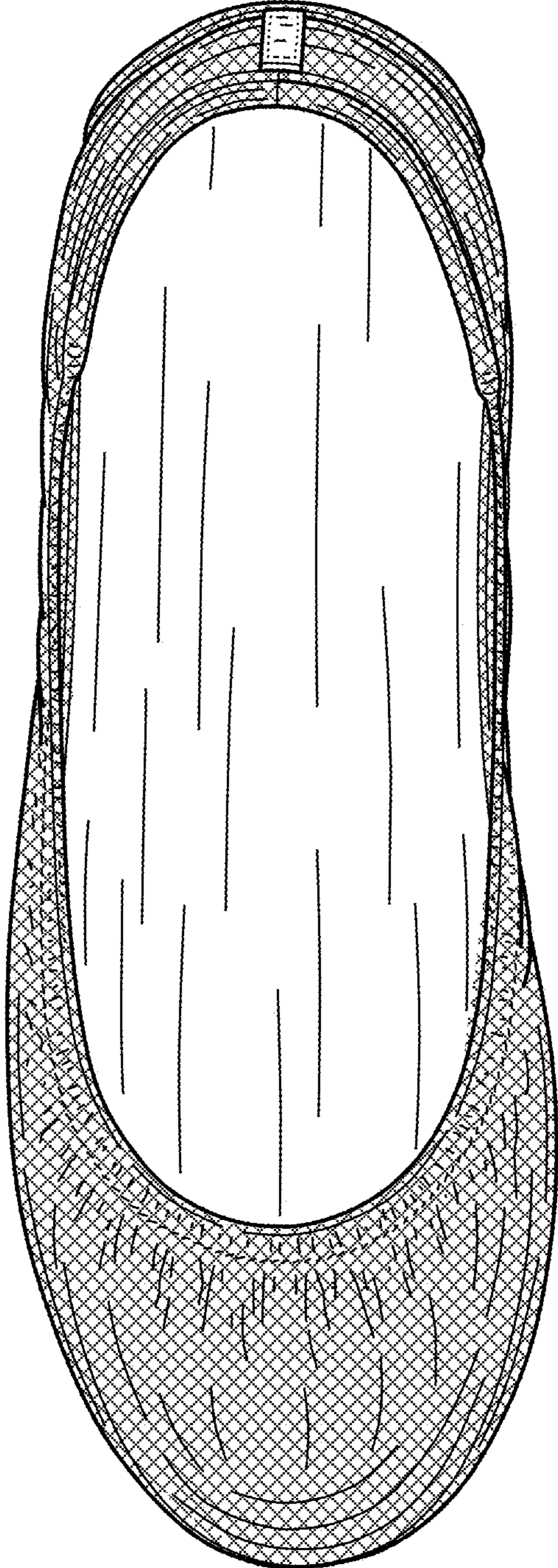

FIG. 4

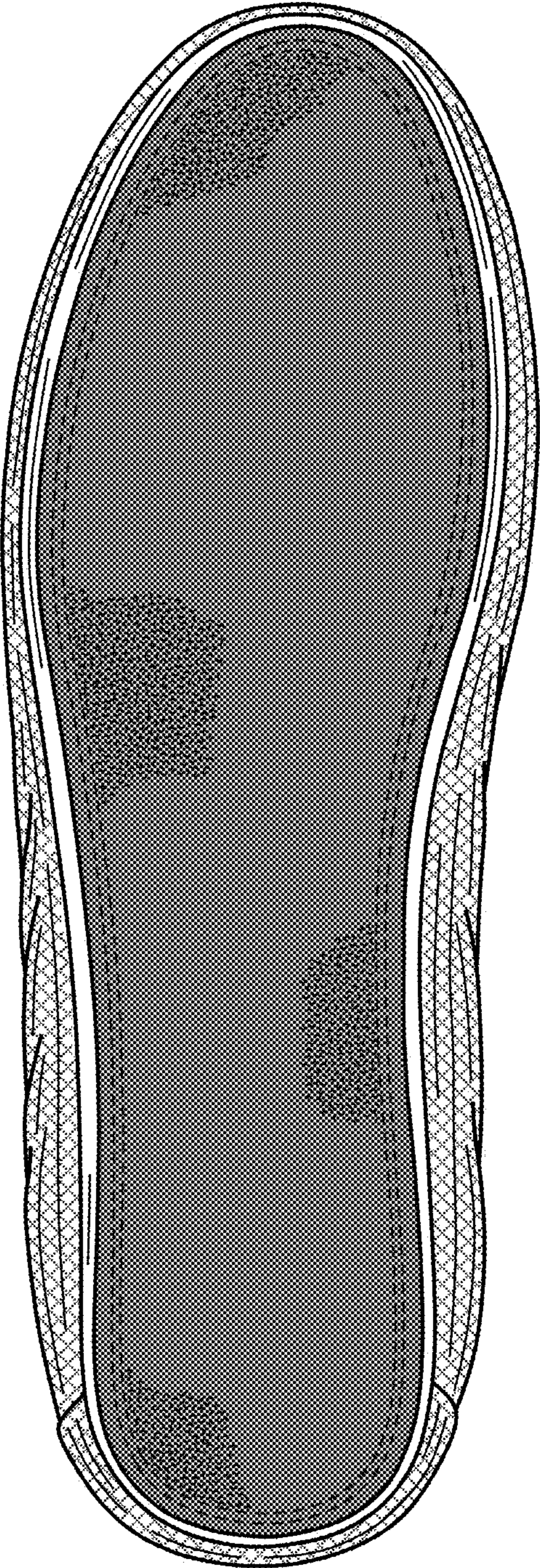

FIG. 5

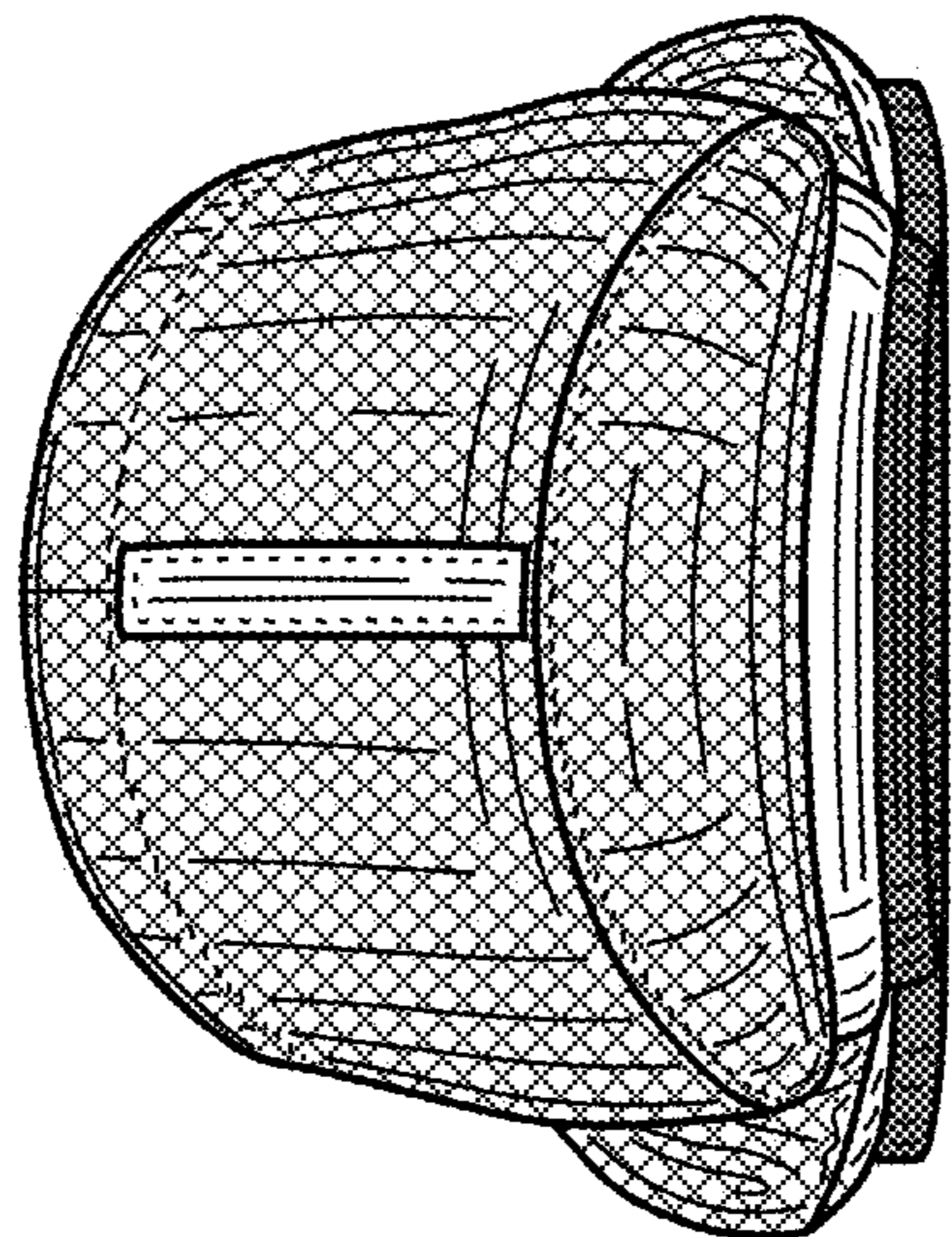

FIG. 7

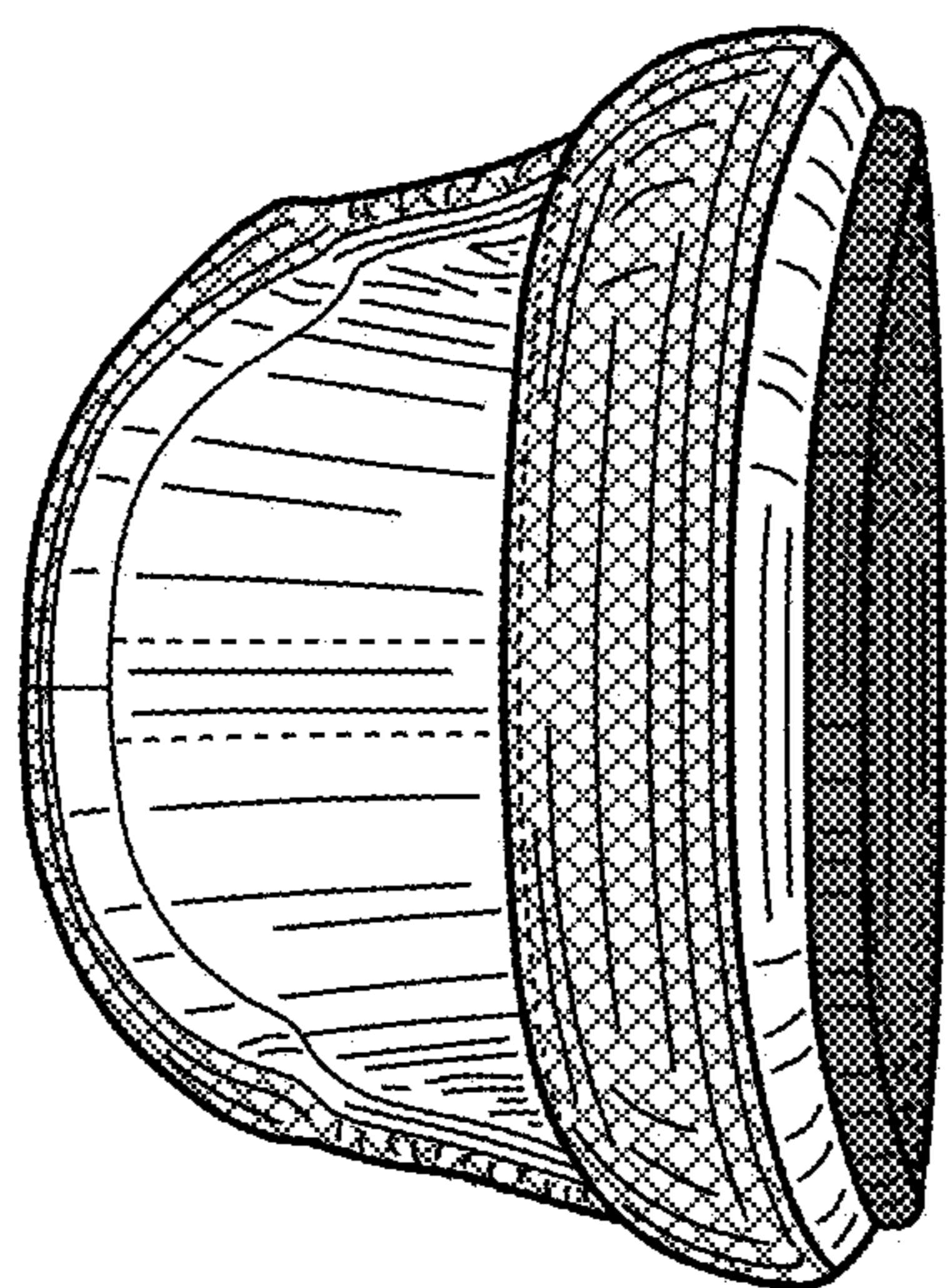

FIG. 6

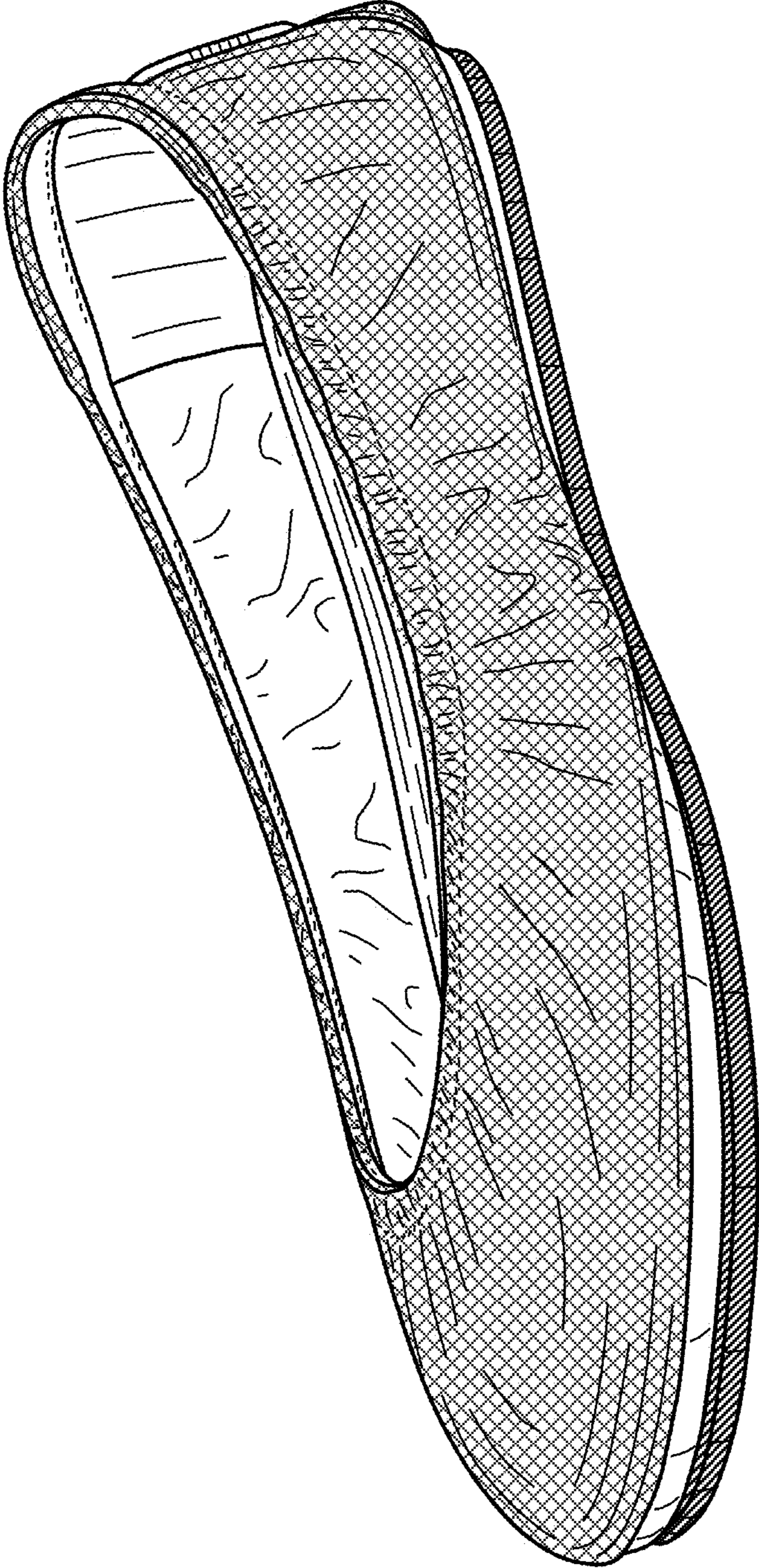

FIG. 8

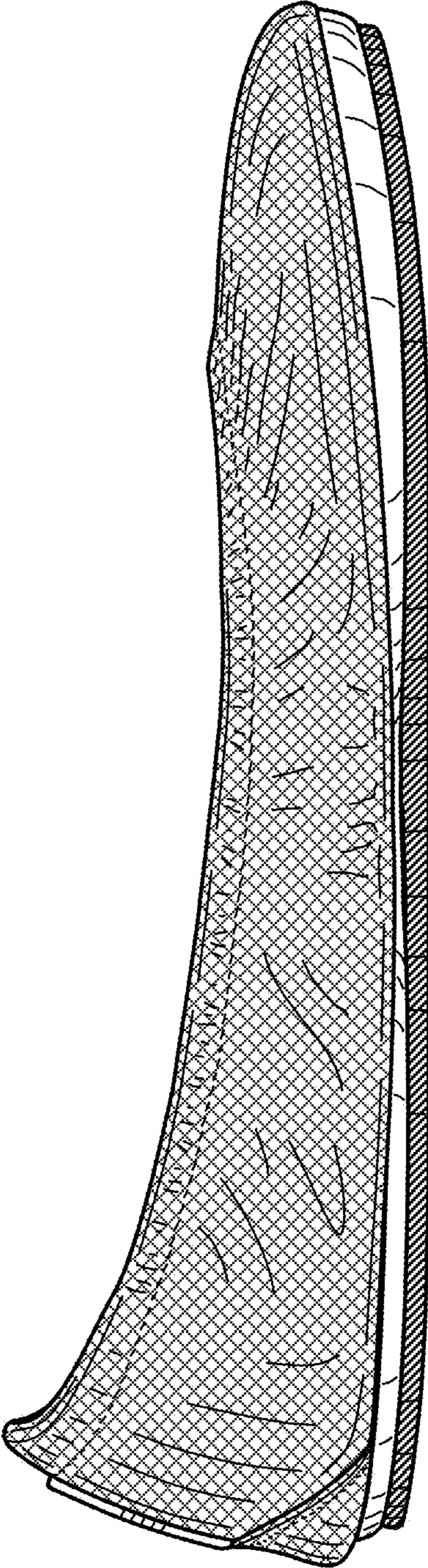

FIG. 9

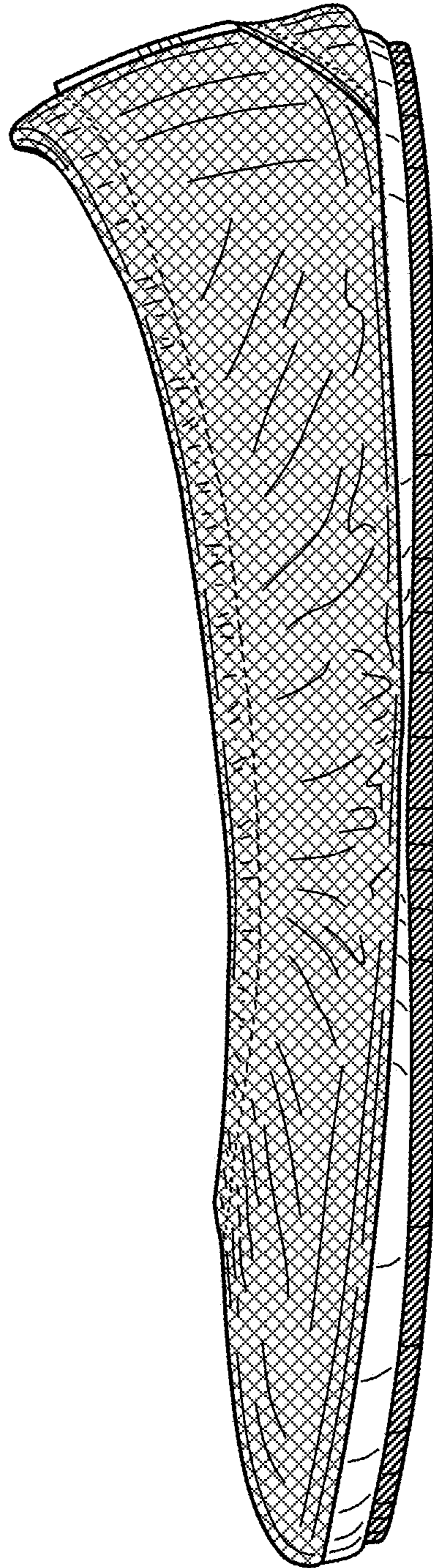

FIG. 10

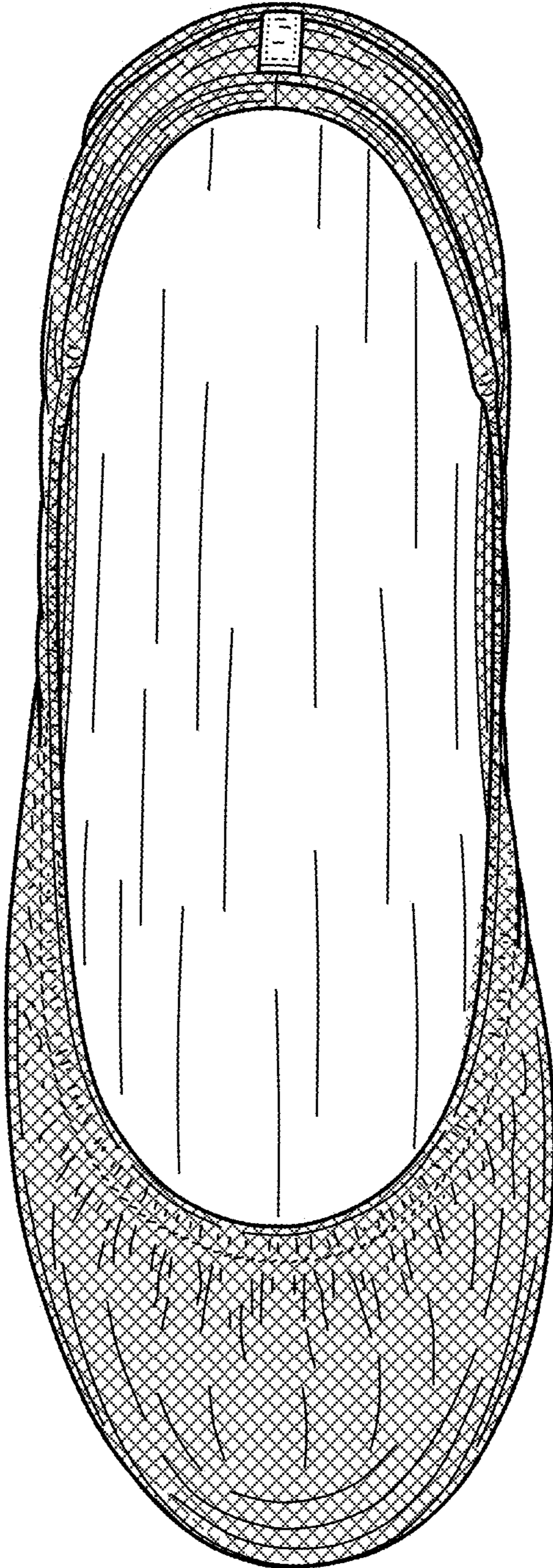

FIG. 11

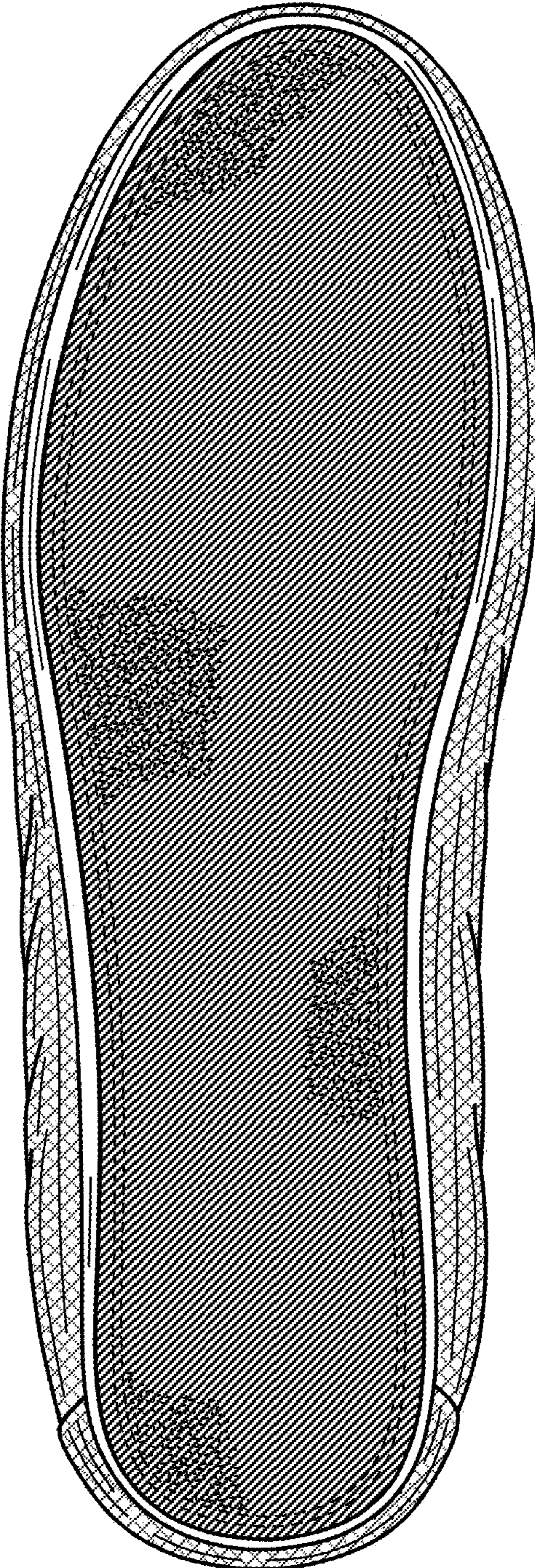

FIG. 12

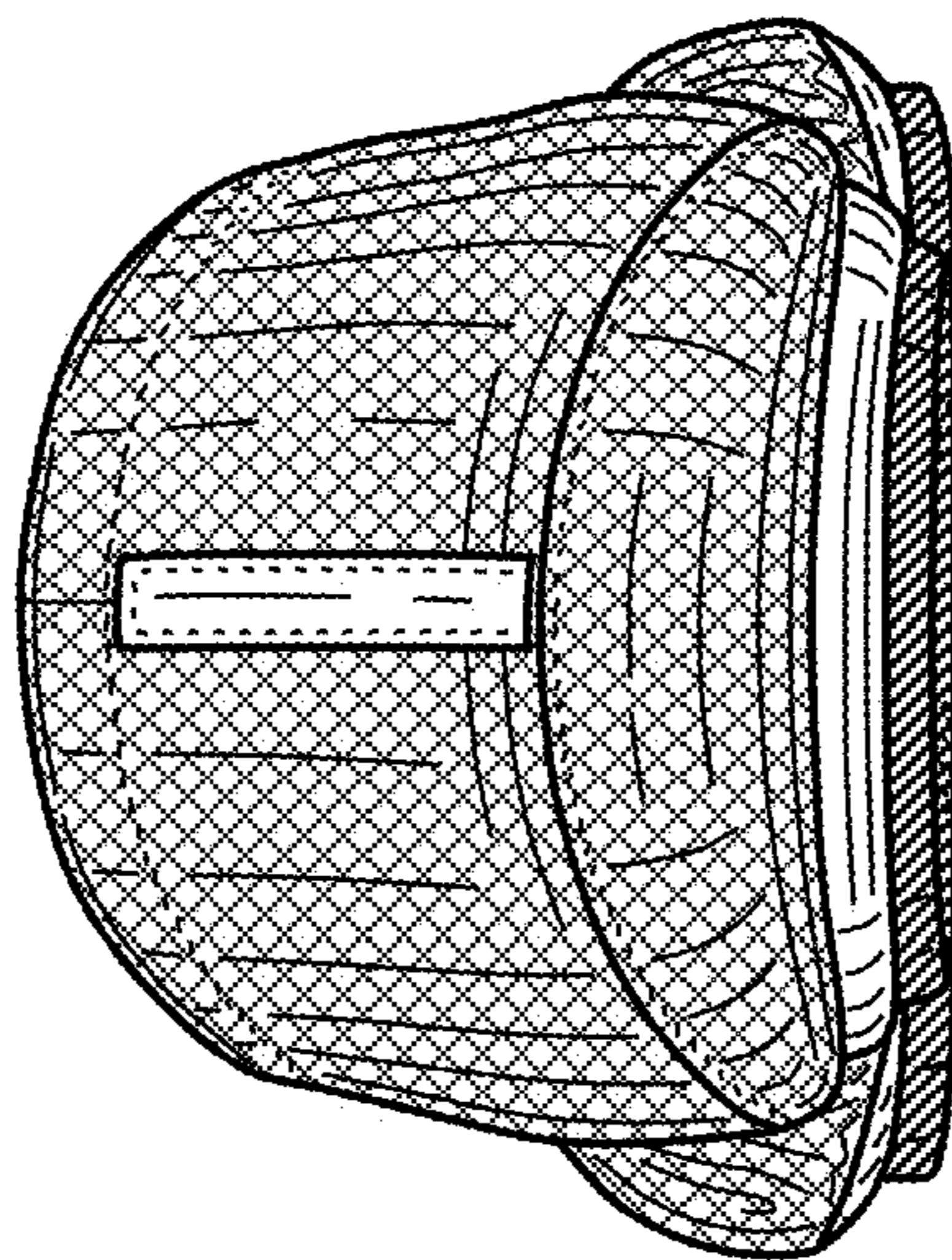

FIG. 14

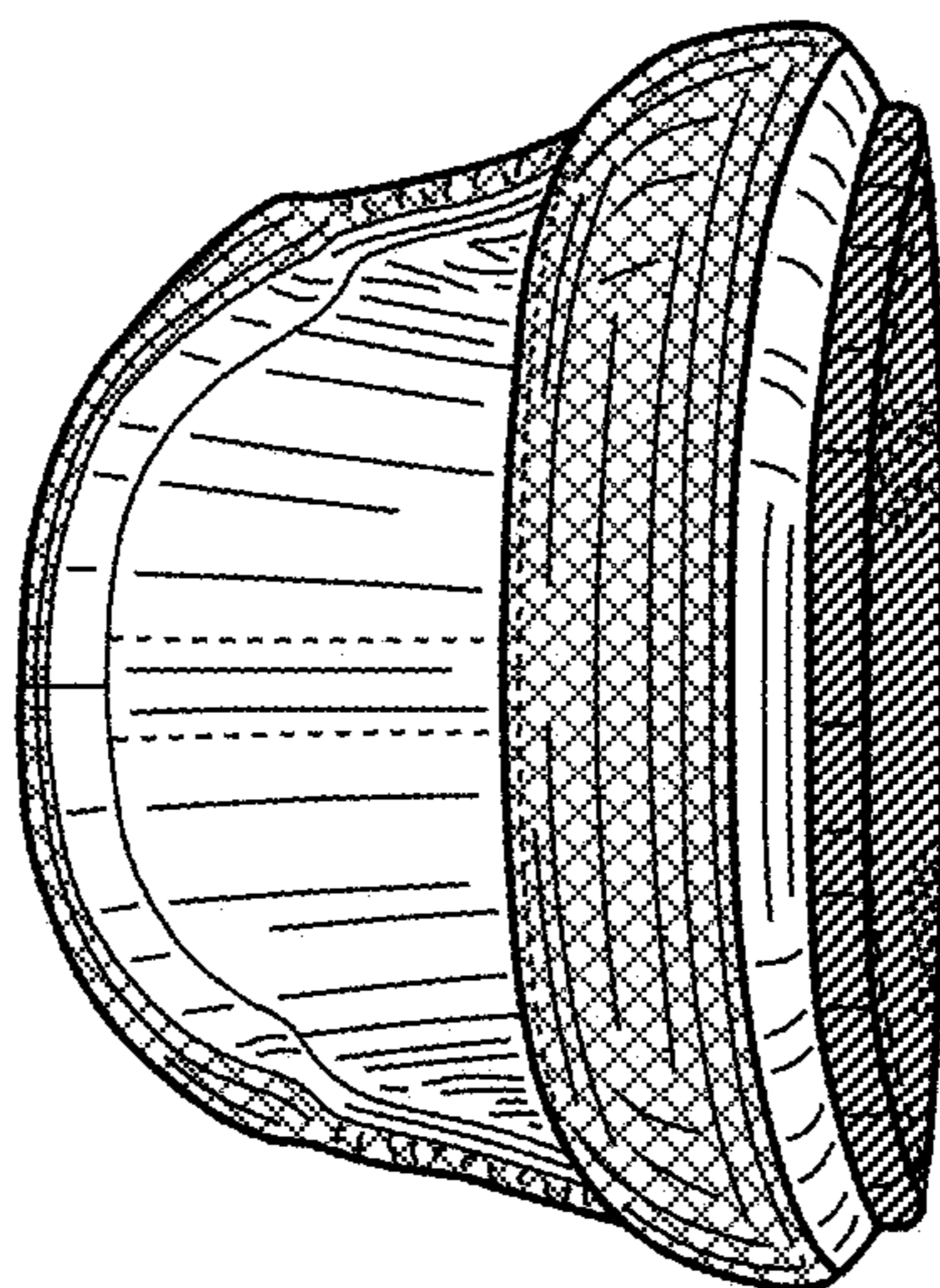

FIG. 13