



US00D750697S

(12) **United States Design Patent**
Hsu

(10) **Patent No.:** **US D750,697 S**
(45) **Date of Patent:** **** Mar. 1, 2016**

(54) **EYEGLASSES FRAME**

(71) Applicant: **WenYi Hsu**, Ontario, CA (US)

(72) Inventor: **WenYi Hsu**, Ontario, CA (US)

(**) Term: **14 Years**

(21) Appl. No.: **29/516,008**

(22) Filed: **Jan. 28, 2015**

(51) **LOC (10) Cl.** **16-06**

(52) **U.S. Cl.**
USPC **D16/326**

(58) **Field of Classification Search**
USPC D16/101, 300–342, 900; D29/109–110;
351/41, 44, 51–52, 62, 158, 92,
351/103–123, 140–153, 63, 59, 45–48;
2/426–432, 447–449, 441, 434–437,
2/440, 442, 13, 15; D21/483, 659–661;
D14/372

CPC G02C 2200/08; G02C 1/06; G02C 5/14;
G02C 11/02; G02C 11/04; G01C 5/16;
A61M 2021/0044; A63B 33/002

See application file for complete search history.

(56) **References Cited**

U.S. PATENT DOCUMENTS

D584,335 S * 1/2009 Baden D16/326
D645,076 S * 9/2011 Markovitz D16/326

D646,707 S * 10/2011 Sheldon D16/326
D648,771 S * 11/2011 Rohrbach D16/325
D649,579 S * 11/2011 Thixton D16/321
D667,866 S * 9/2012 Lombardi D16/323
D691,193 S * 10/2013 Lombardi D16/326
D701,896 S * 4/2014 Markovitz D16/326
D705,847 S * 5/2014 Szymanski D16/303
D718,805 S * 12/2014 Markovitz D16/326
D735,261 S * 7/2015 Hsu D16/309
D735,262 S * 7/2015 Hsu D16/309
D746,361 * 12/2015 Markovitz D16/326

* cited by examiner

Primary Examiner — Raphael Barkai

(74) *Attorney, Agent, or Firm* — Alexander Chen, Esq.

(57) **CLAIM**

I claim, an ornamental design for an eyeglasses frame, as shown and described.

DESCRIPTION

FIG. 1 is a perspective view of top, front, left side of the eyeglasses frame.

FIG. 2 is a front view thereof;

FIG. 3 is a back view thereof;

FIG. 4 is a right view thereof;

FIG. 5 is a left view thereof;

FIG. 6 is a top view thereof; and,

FIG. 7 is a bottom view thereof.

1 Claim, 7 Drawing Sheets

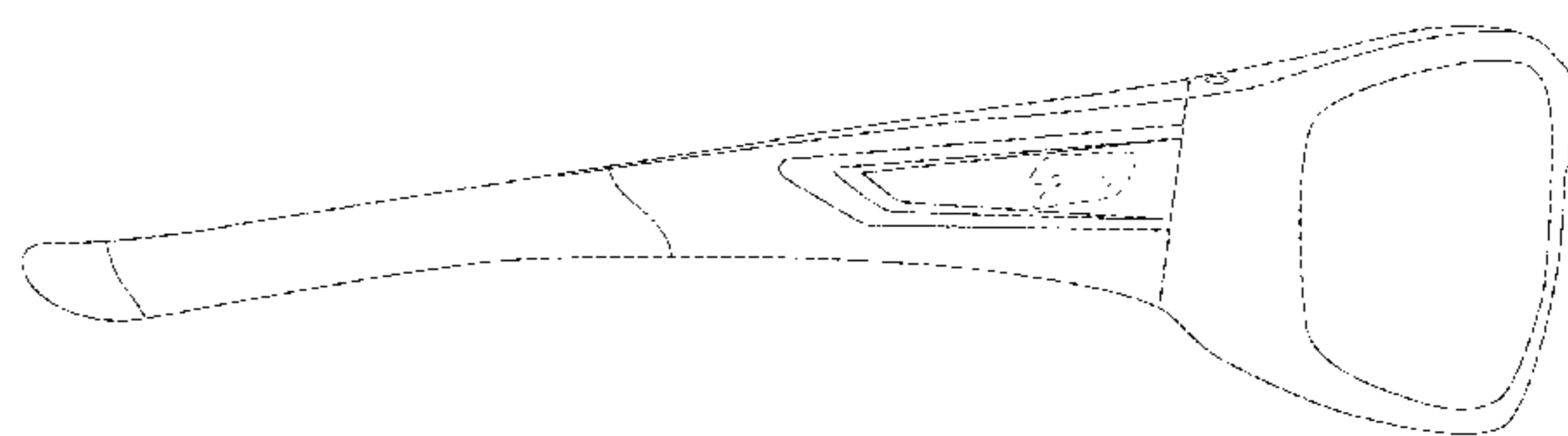
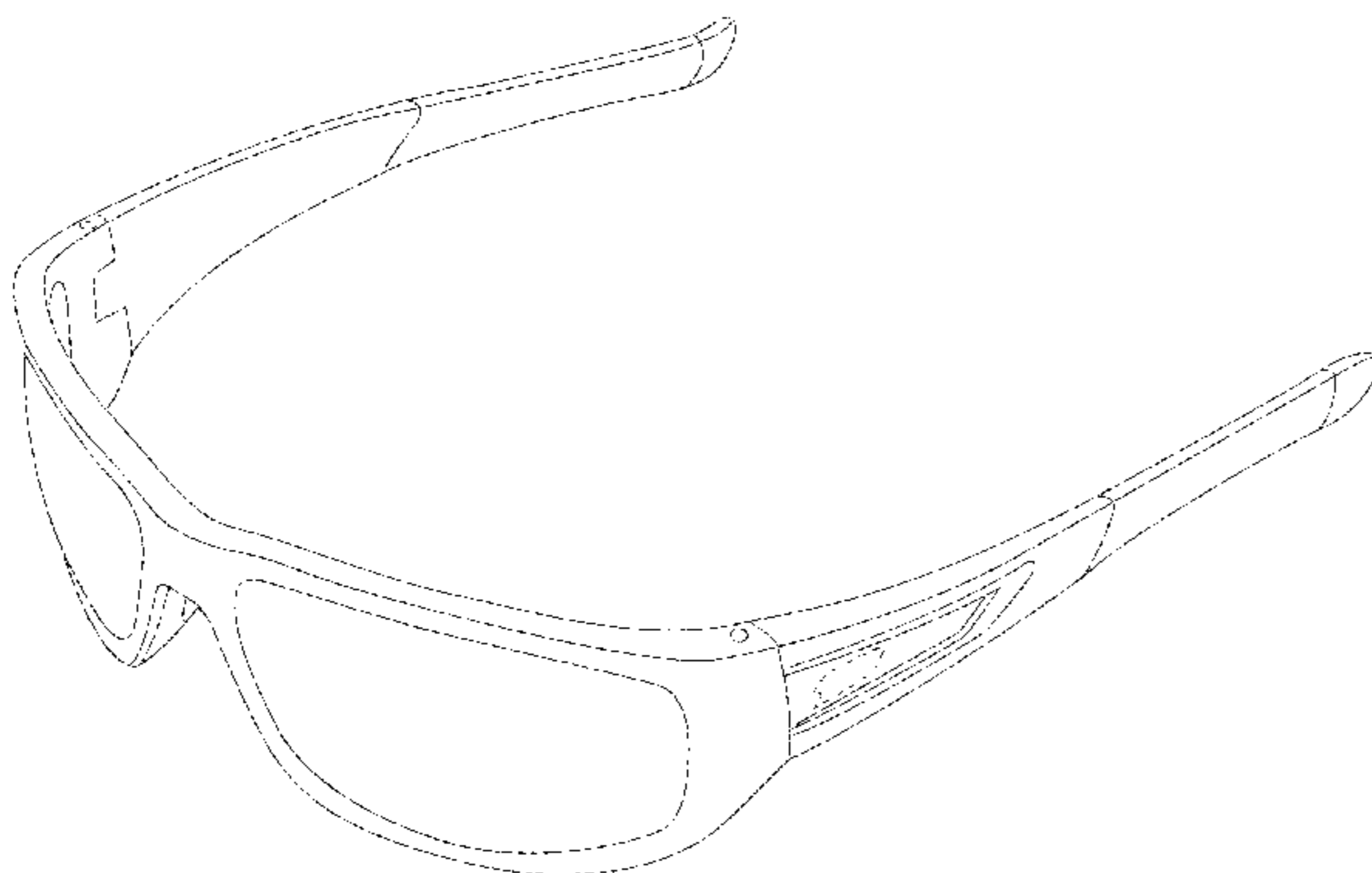

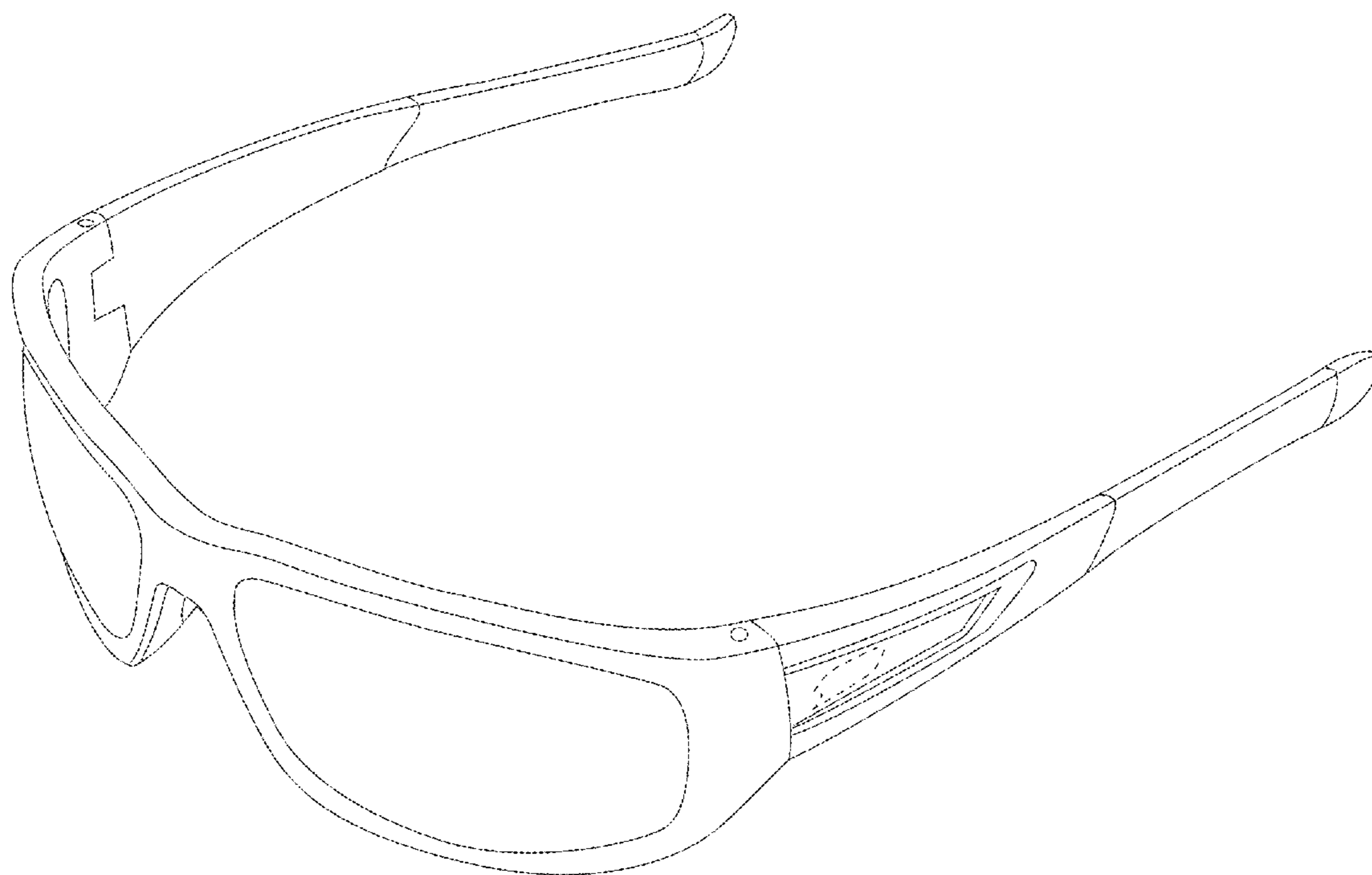

FIG. 1

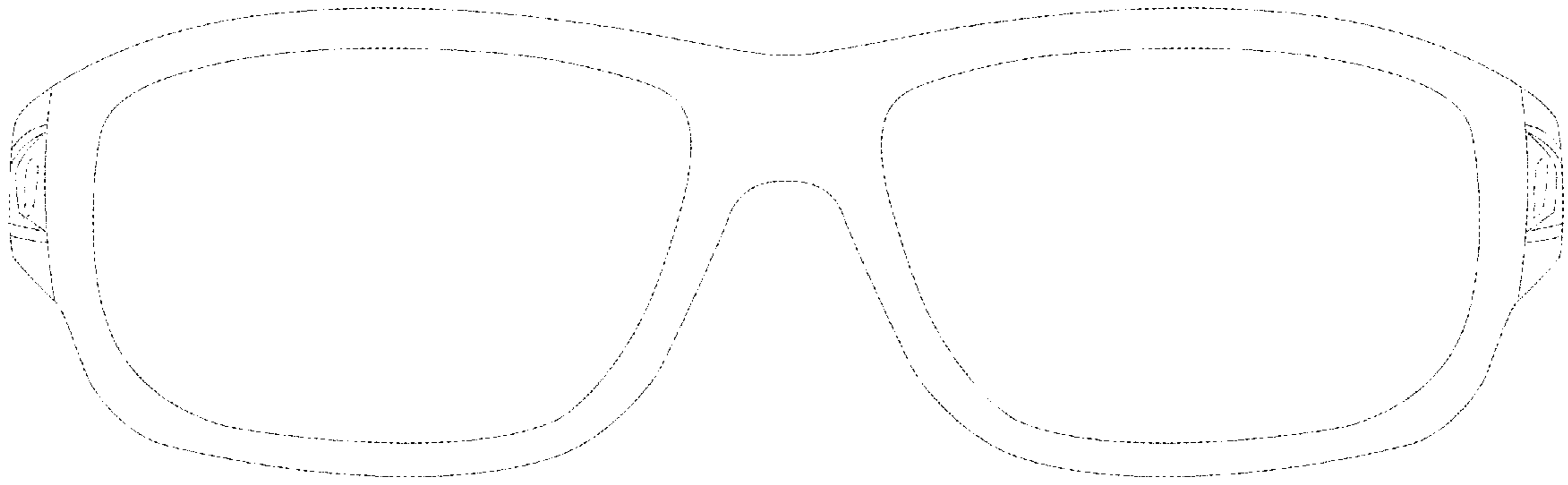

FIG. 2

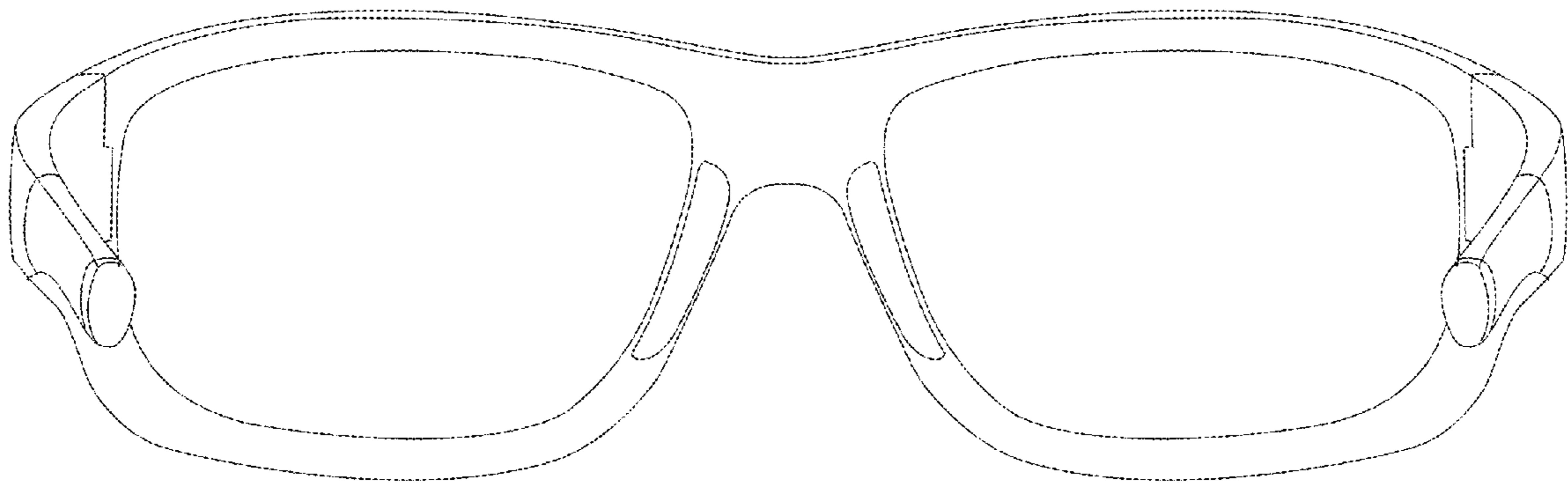

FIG. 3

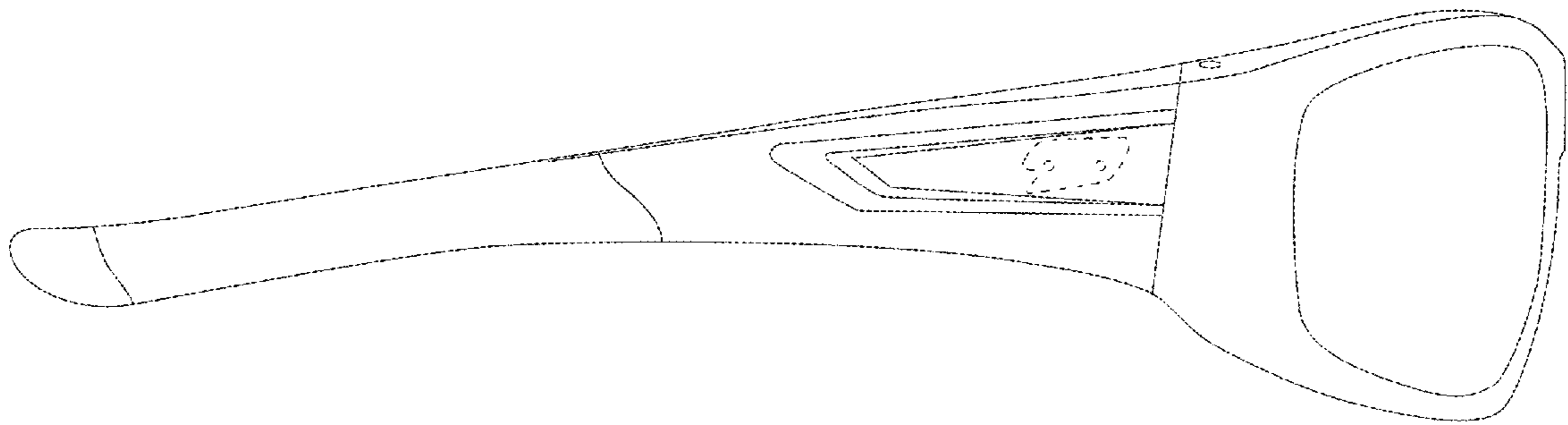

FIG. 4

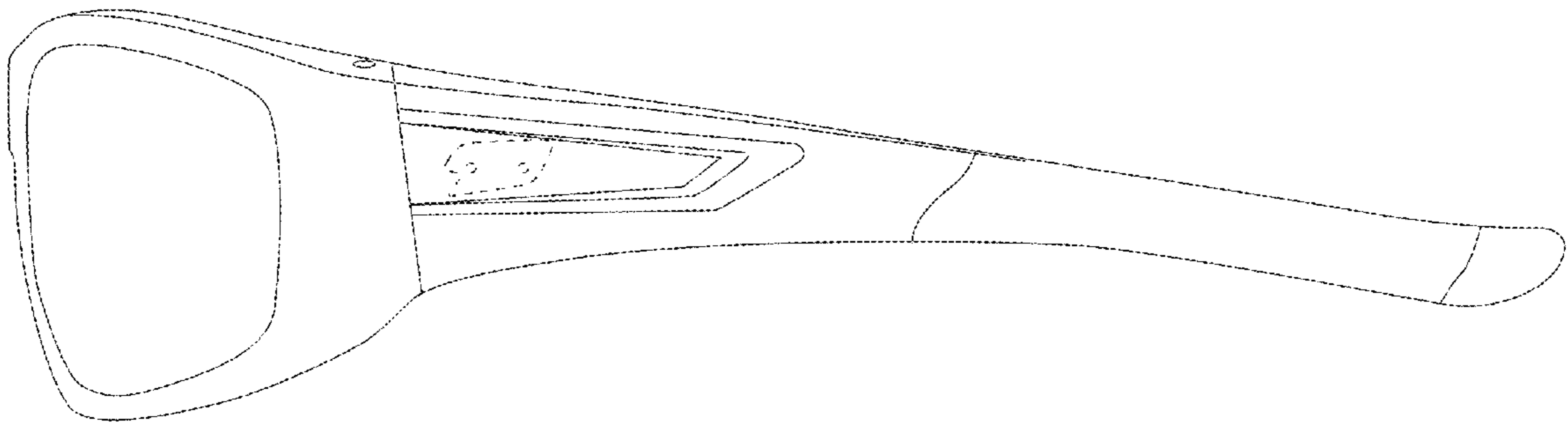

FIG. 5

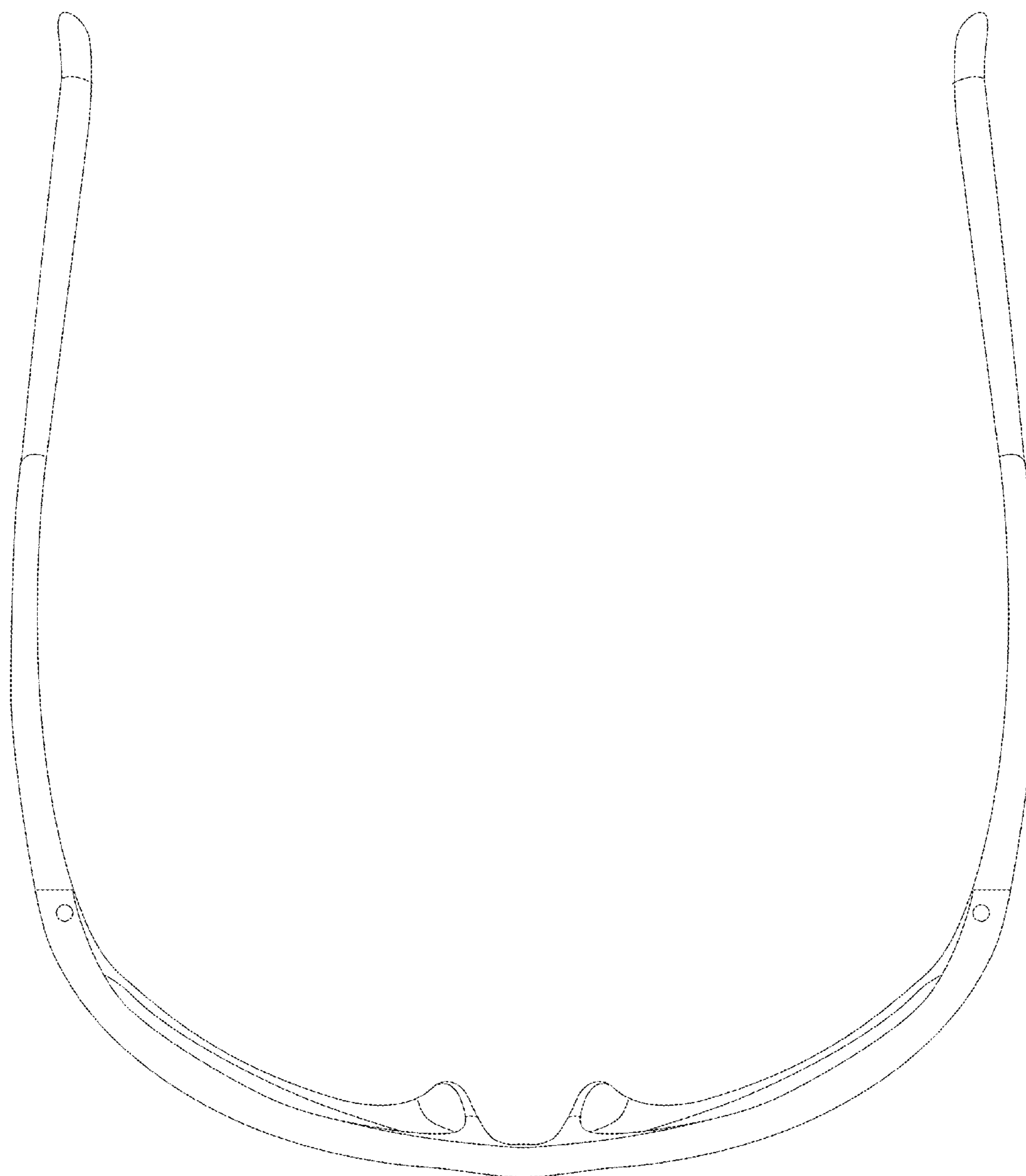

FIG. 6



FIG. 7