



US00D750694S

(12) **United States Design Patent**
Hsu

(10) **Patent No.:** **US D750,694 S**
(45) **Date of Patent:** **** Mar. 1, 2016**

(54) **EYEGLASSES FRAME**

(71) Applicant: **WenYi Hsu**, Ontario, CA (US)

(72) Inventor: **WenYi Hsu**, Ontario, CA (US)

(**) Term: **14 Years**

(21) Appl. No.: **29/516,013**

(22) Filed: **Jan. 28, 2015**

(51) **LOC (10) Cl.** **16-06**

(52) **U.S. Cl.**
USPC **D16/315**; D16/326

(58) **Field of Classification Search**
USPC D16/101, 300–342, 900; D29/109–110;
351/41, 44, 51–52, 62, 158, 92,
351/103–123, 140–153, 63, 59, 45–48;
2/426–432, 447–449, 441, 434–437,
2/440, 442, 13, 15; D21/483, 659–661;
D14/372

CPC G02C 2200/08; G02C 1/06; G02C 5/14;
G02C 11/02; G02C 11/04; G01C 5/16;
A61M 2021/0044; A63B 33/002

See application file for complete search history.

(56) **References Cited**

U.S. PATENT DOCUMENTS

D381,671 S * 7/1997 Tan D16/315
D420,034 S * 2/2000 Actis-Datta D16/315
6,460,996 B2 * 10/2002 Okui G02C 1/06

6,491,388 B1 * 12/2002 Chen G02C 1/06
351/106
351/85
D544,518 S * 6/2007 Damen D16/315
D604,759 S * 11/2009 Rohrbach D16/326
D640,309 S * 6/2011 Suzuki D16/306
D647,126 S * 10/2011 Chou D16/315
D650,825 S * 12/2011 Yee D16/325
D652,442 S * 1/2012 Yee D16/326
D706,859 S * 6/2014 Markovitz D16/326
D706,860 S * 6/2014 Markovitz D16/326
D725,177 S * 3/2015 Crescenzi D16/326

* cited by examiner

Primary Examiner — Raphael Barkai

(74) *Attorney, Agent, or Firm* — Alexander Chen, Esq.

(57) **CLAIM**

I claim, an ornamental design for an eyeglasses frame, as shown and described.

DESCRIPTION

FIG. 1 is a perspective view of top, front, left side of the eyeglasses frame.

FIG. 2 is a front view thereof;

FIG. 3 is a back view thereof;

FIG. 4 is a right view thereof;

FIG. 5 is a left view thereof;

FIG. 6 is a top view thereof; and,

FIG. 7 is a bottom view thereof.

1 Claim, 7 Drawing Sheets

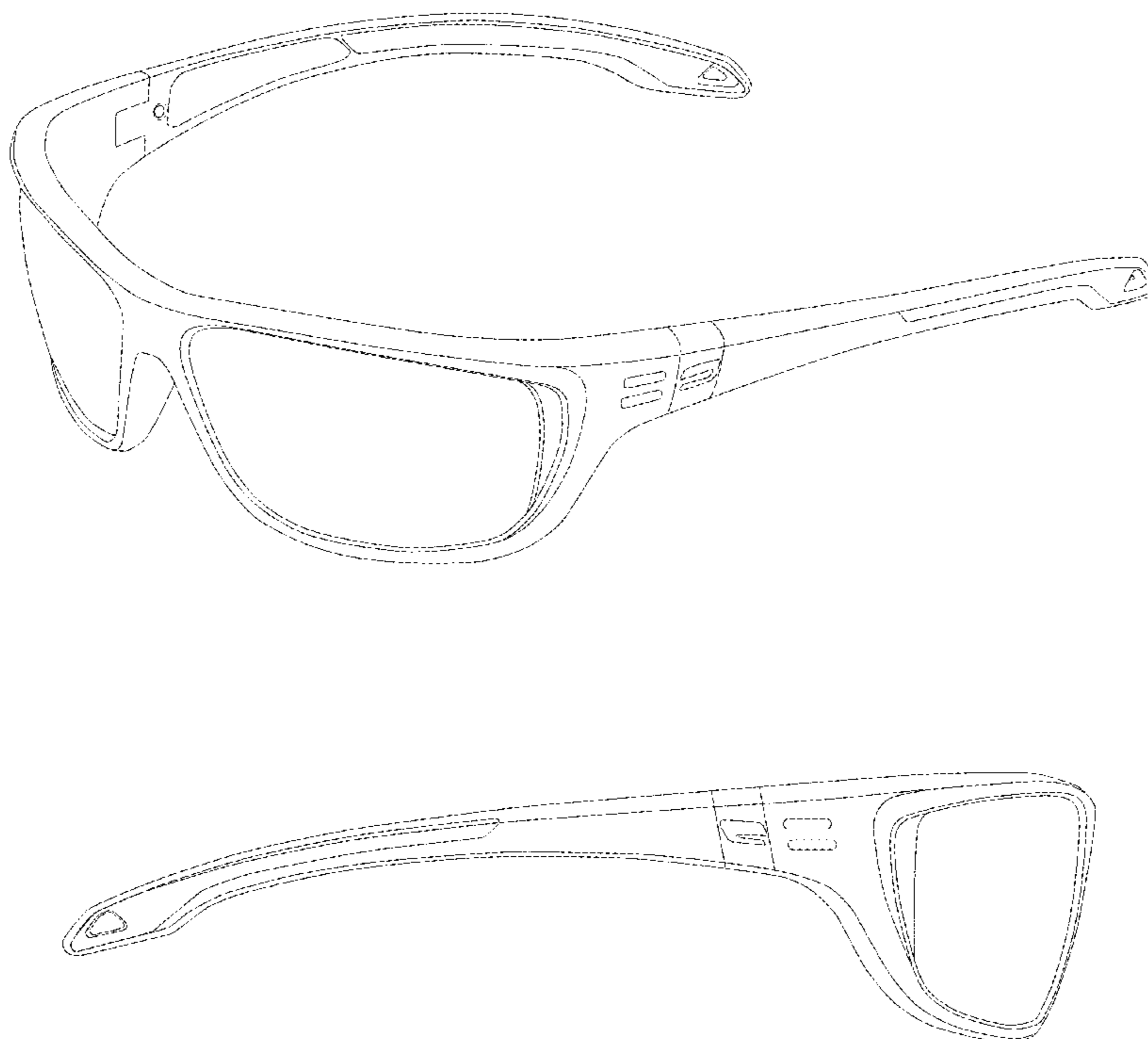

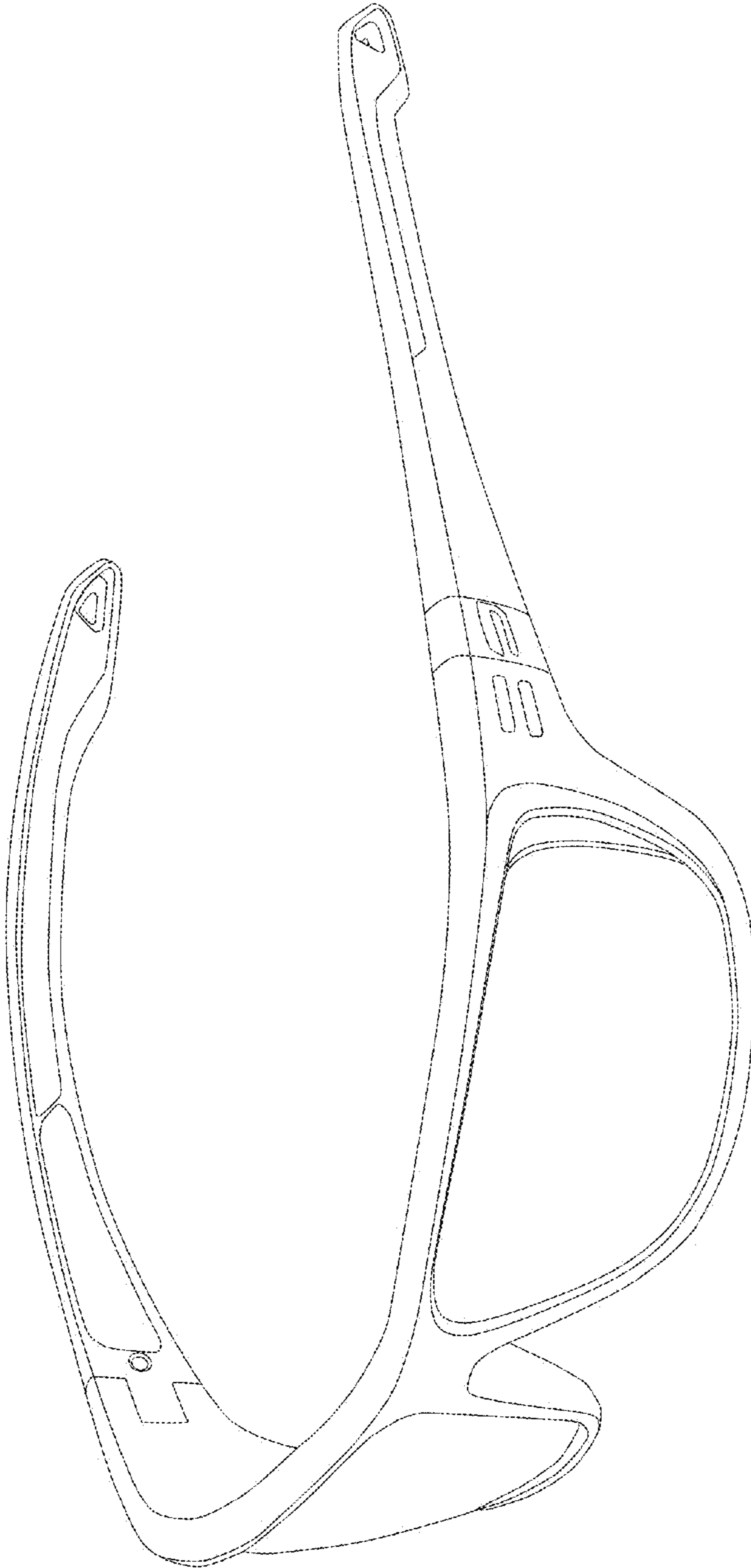

FIG. 1

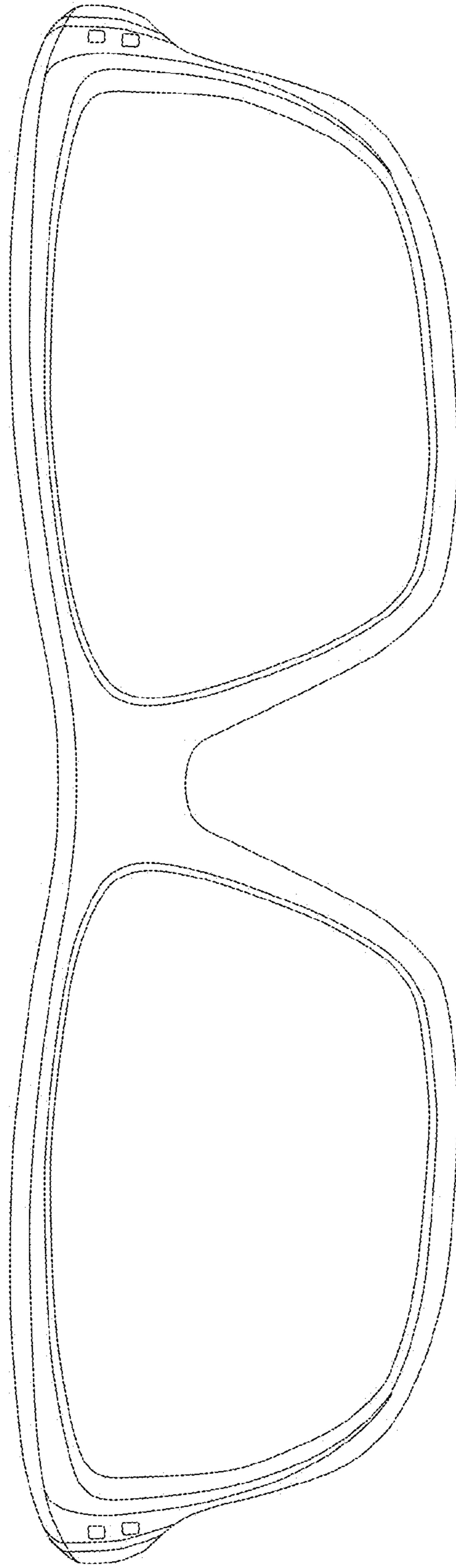

FIG. 2

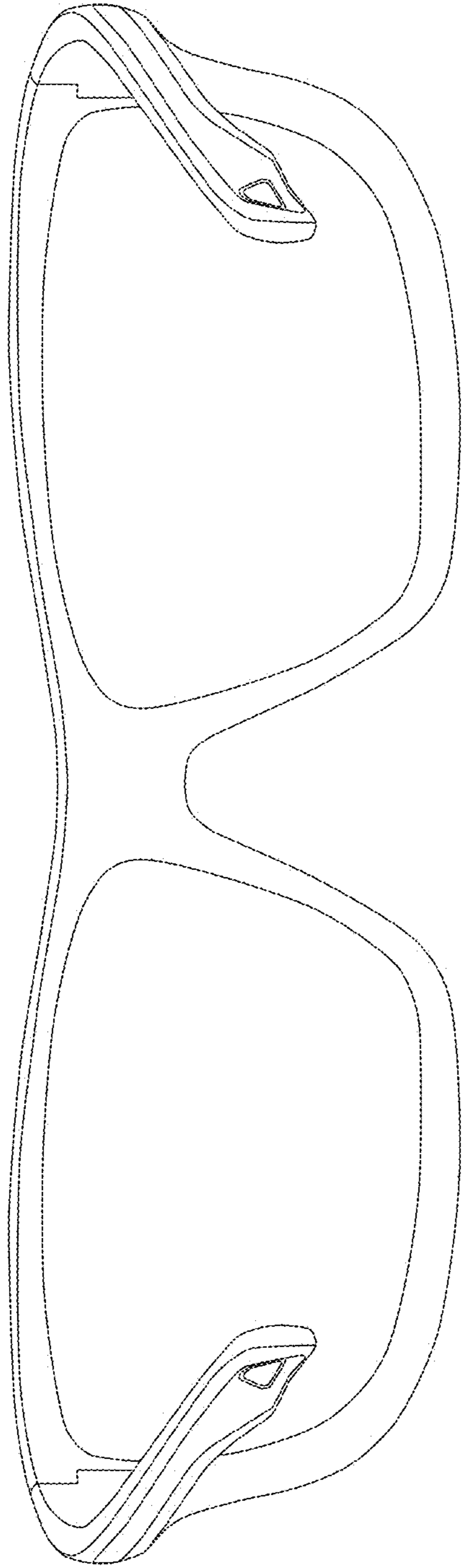

FIG. 3

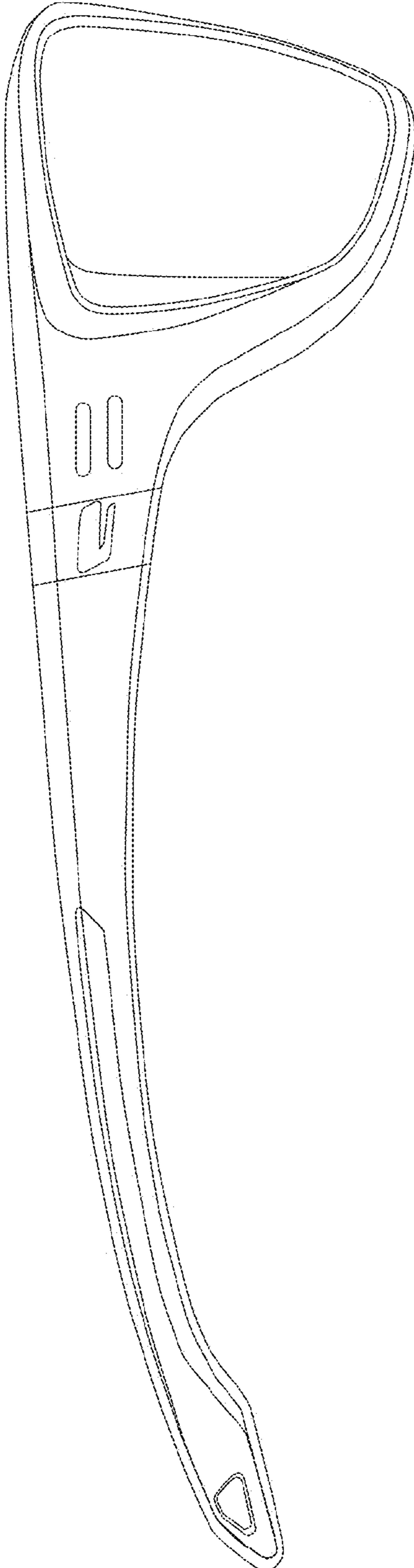

FIG.4

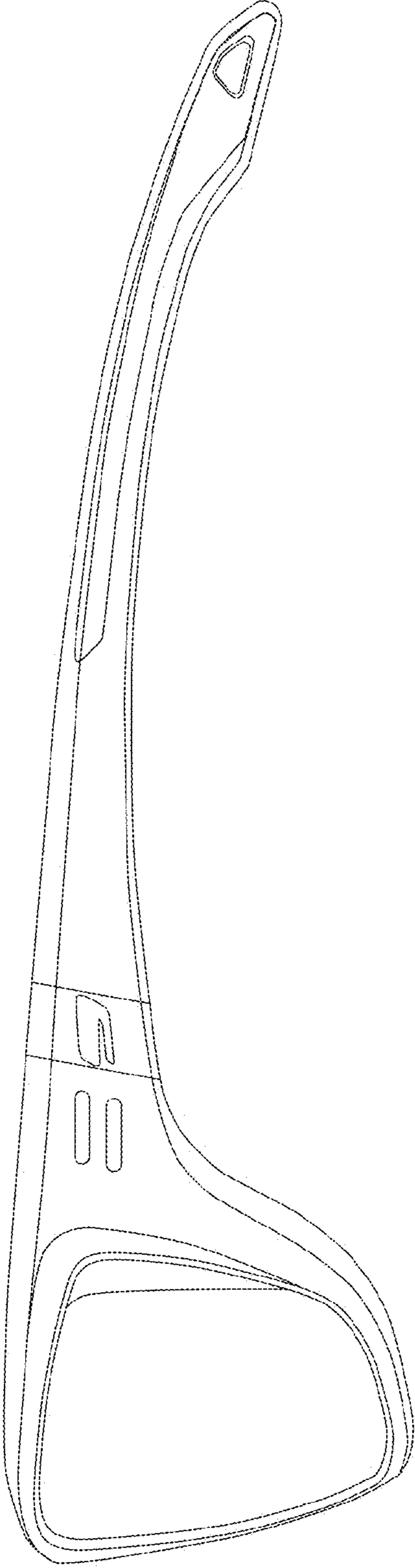

FIG. 5

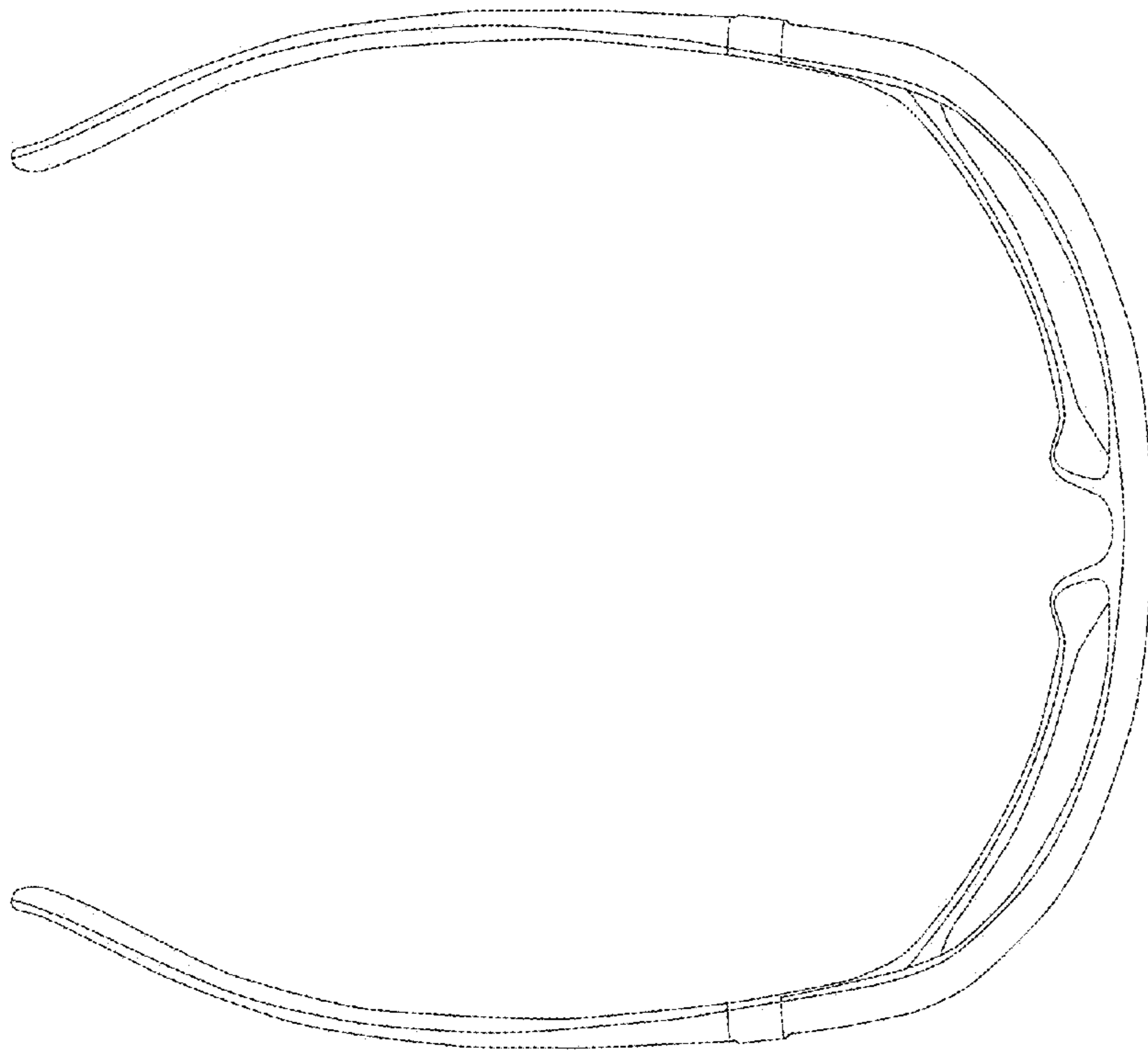

FIG. 6

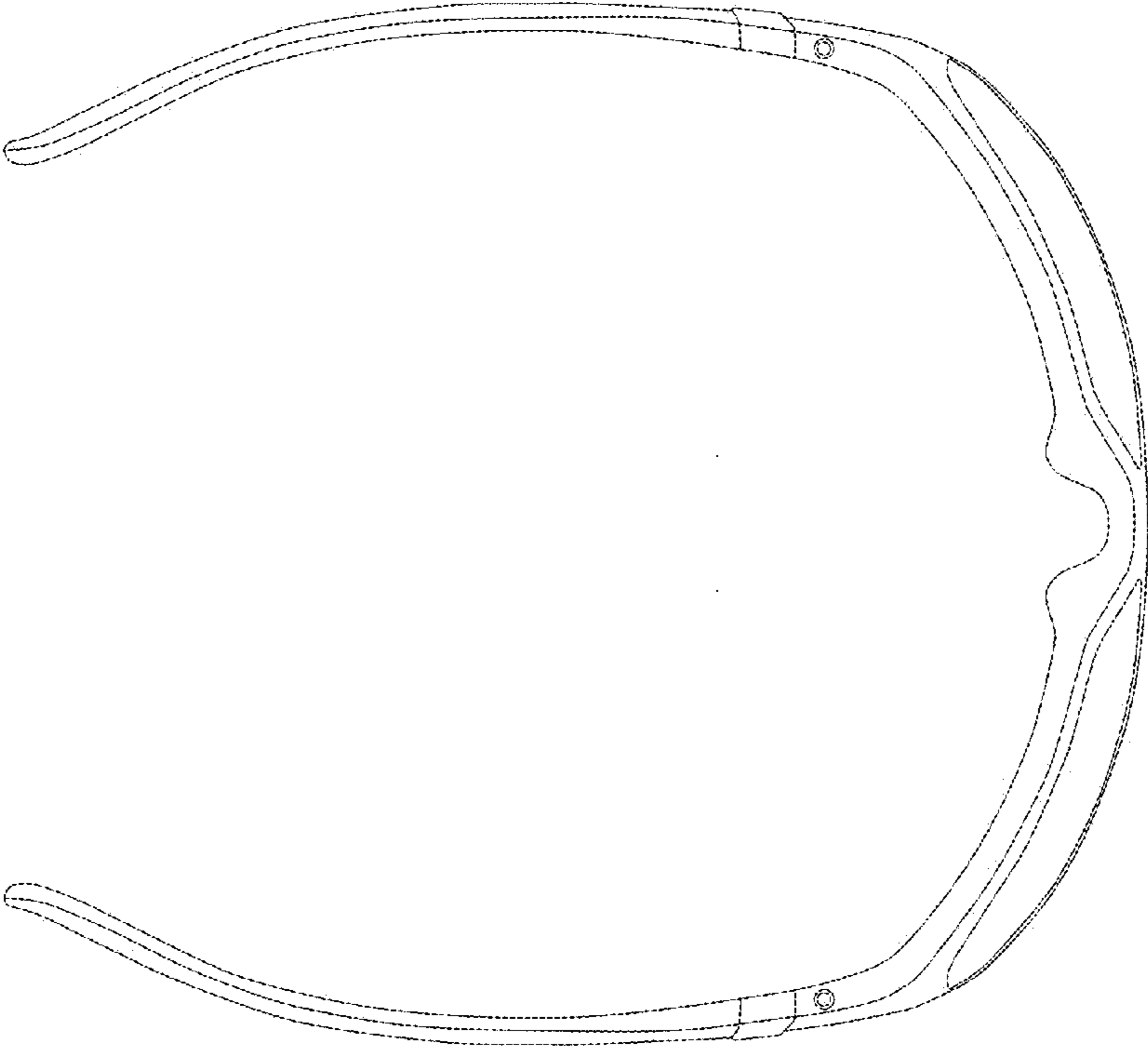

FIG.7