



US00D750623S

(12) **United States Design Patent**  
**Park et al.**

(10) **Patent No.:** **US D750,623 S**  
(45) **Date of Patent:** **\*\* Mar. 1, 2016**

- (54) **SMART WATCH**
- (71) Applicant: **Samsung Electronics Co., Ltd.**,  
Suwon-si (KR)
- (72) Inventors: **Sang-II Park**, Namyangju-Si (KR);  
**Se-O Lee**, Sungname-Si (KR)
- (73) Assignee: **Samsung Electronics Co., Ltd.**,  
Suwon-si (KR)
- (\*\*) Term: **14 Years**
- (21) Appl. No.: **29/472,972**
- (22) Filed: **Nov. 18, 2013**
- (30) **Foreign Application Priority Data**  
May 16, 2013 (KR) ..... 30-2013-0025856
- (51) **LOC (10) Cl.** ..... **14-02**
- (52) **U.S. Cl.**  
USPC ..... **D14/344**; D10/38
- (58) **Field of Classification Search**  
USPC ..... D10/15, 28, 30-32, 38, 39, 128, 132;  
D11/3, 4, 200; D14/138 R, 144, 344;  
D18/4.5; D24/187; 63/9; 224/170, 219;  
368/10, 69, 82 X, 276, 281-283, 316;  
455/575.6; 600/595  
CPC .. A61B 5/681; H01H 2209/018; H04W 4/027  
See application file for complete search history.

- (56) **References Cited**  
**U.S. PATENT DOCUMENTS**  
D342,208 S \* 12/1993 Tsukada et al. .... D10/30  
5,418,760 A \* 5/1995 Kawashima et al. .... 368/69  
D567,676 S \* 4/2008 Tang ..... D10/32  
D576,501 S \* 9/2008 Tang ..... D10/32

- D626,435 S \* 11/2010 Tanaka et al. .... D10/31
- D638,723 S \* 5/2011 Ong ..... D10/32
- D703,069 S \* 4/2014 Adams et al. .... D10/31
- D714,179 S \* 9/2014 Park et al. .... D11/3
- D721,701 S \* 1/2015 Al-Nasser ..... D14/344
- D722,894 S \* 2/2015 Vondle et al. .... D10/32
- 2011/0053666 A1 \* 3/2011 Kang et al. .... 455/575.6
- 2014/0197946 A1 \* 7/2014 Park et al. .... 340/539.11
- 2014/0316305 A1 \* 10/2014 Venkatraman et al. .... 600/595

**OTHER PUBLICATIONS**

Tizen Samsung. Tizen Samsung Gear S Gets Shown Off in Official Video. Sep. 4, 2014 [online], [site visited Jun. 2, 2015]. Available from Internet, <URL:http://www.tizenexperts.com/2014/09/tizen-samsung-gear-s-gets-shown-off-in-official-video/>.\*

\* cited by examiner

*Primary Examiner* — Robert M Spear  
*Assistant Examiner* — Darcey E Heflin  
(74) *Attorney, Agent, or Firm* — NSIP Law

(57) **CLAIM**  
We claim the ornamental design for a smart watch, as shown and described.

**DESCRIPTION**

FIG. 1 is a front perspective view of a smart watch showing our new design;  
FIG. 2 is a front view thereof;  
FIG. 3 is a rear view thereof;  
FIG. 4 is a left-side view thereof;  
FIG. 5 is a right-side view thereof;  
FIG. 6 is a top view thereof; and,  
FIG. 7 is a bottom view thereof.  
The broken lines are for environmental purposes only and form no part of the claimed design.

**1 Claim, 5 Drawing Sheets**

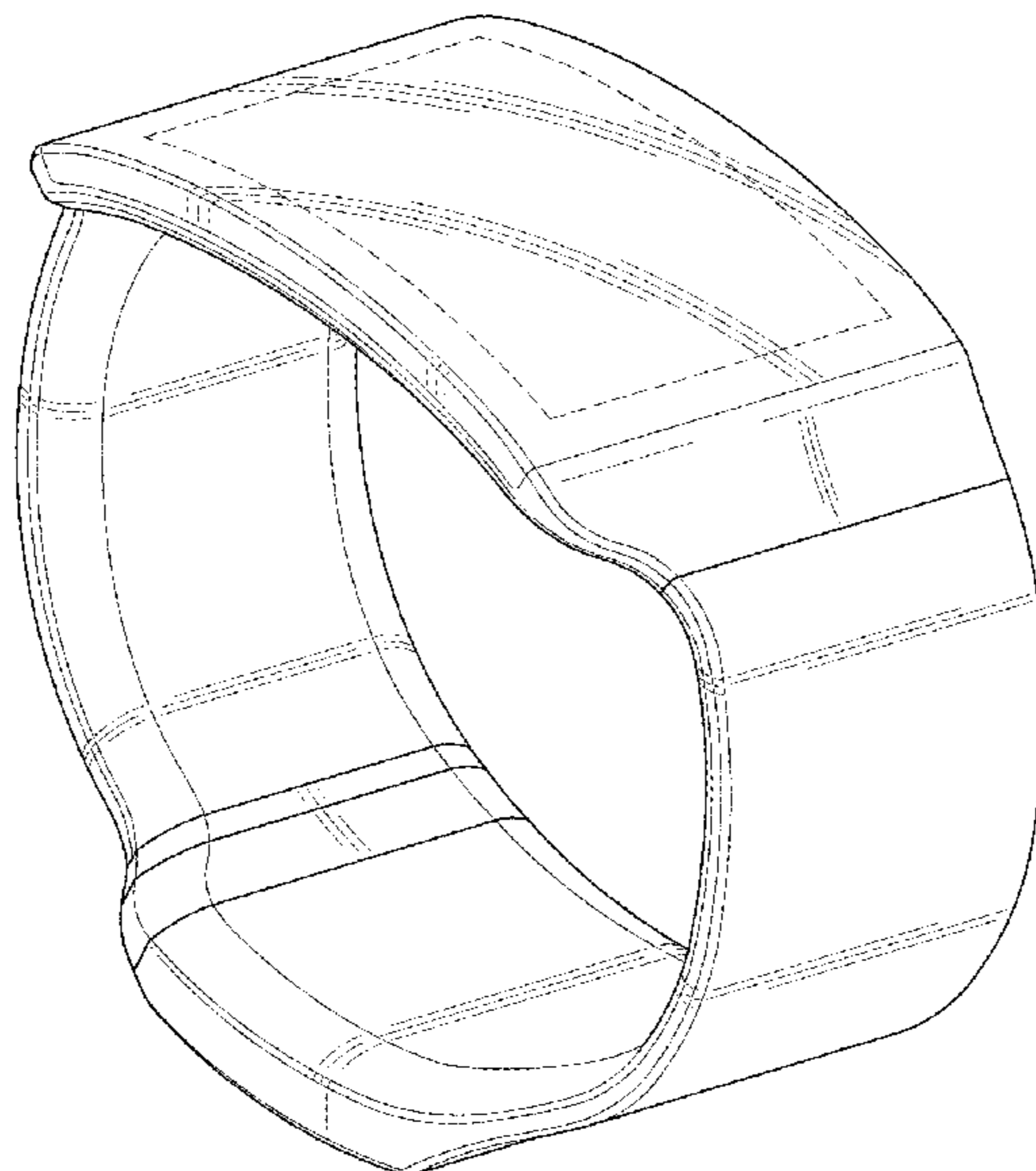

FIG. 1

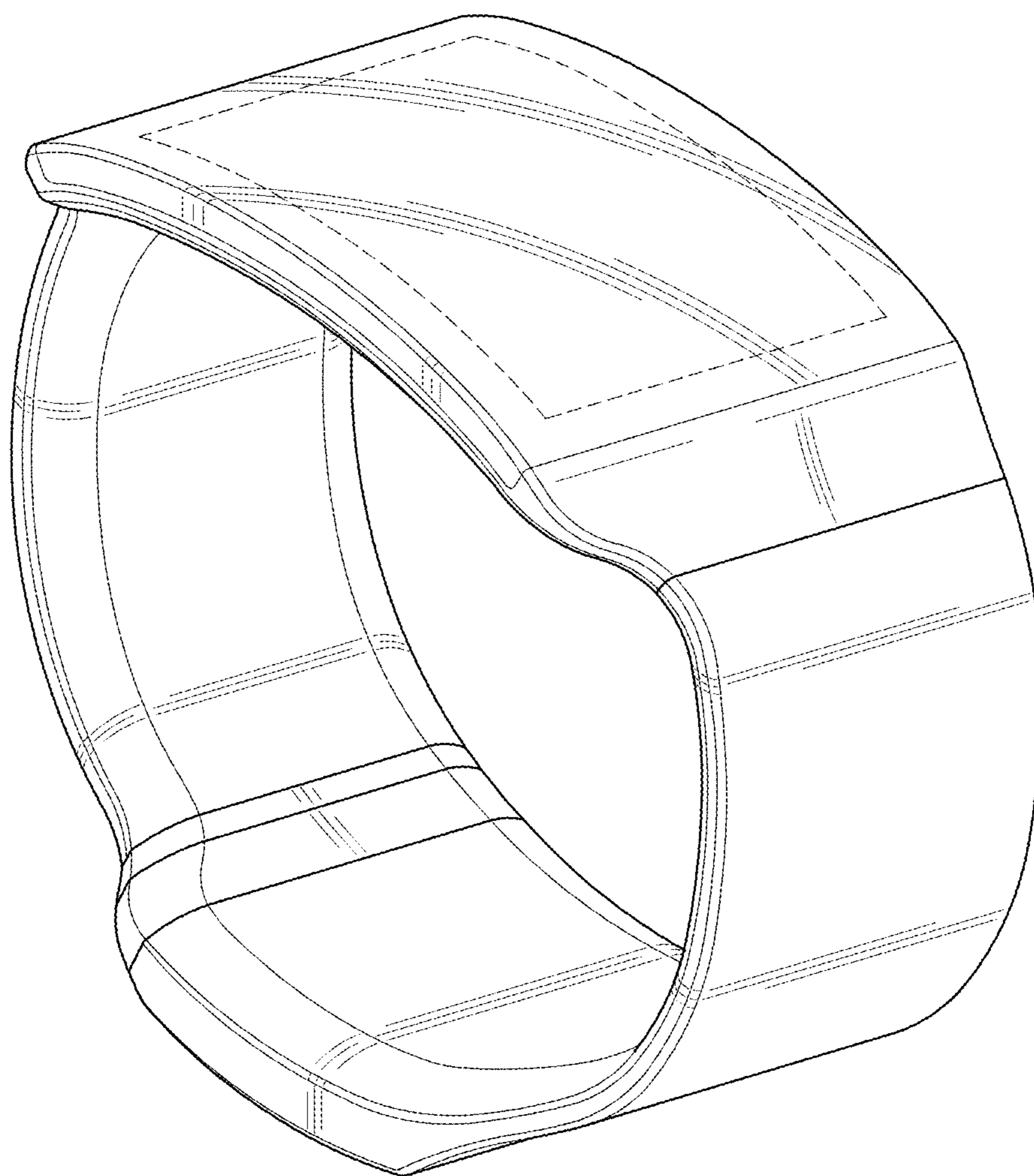

FIG. 2

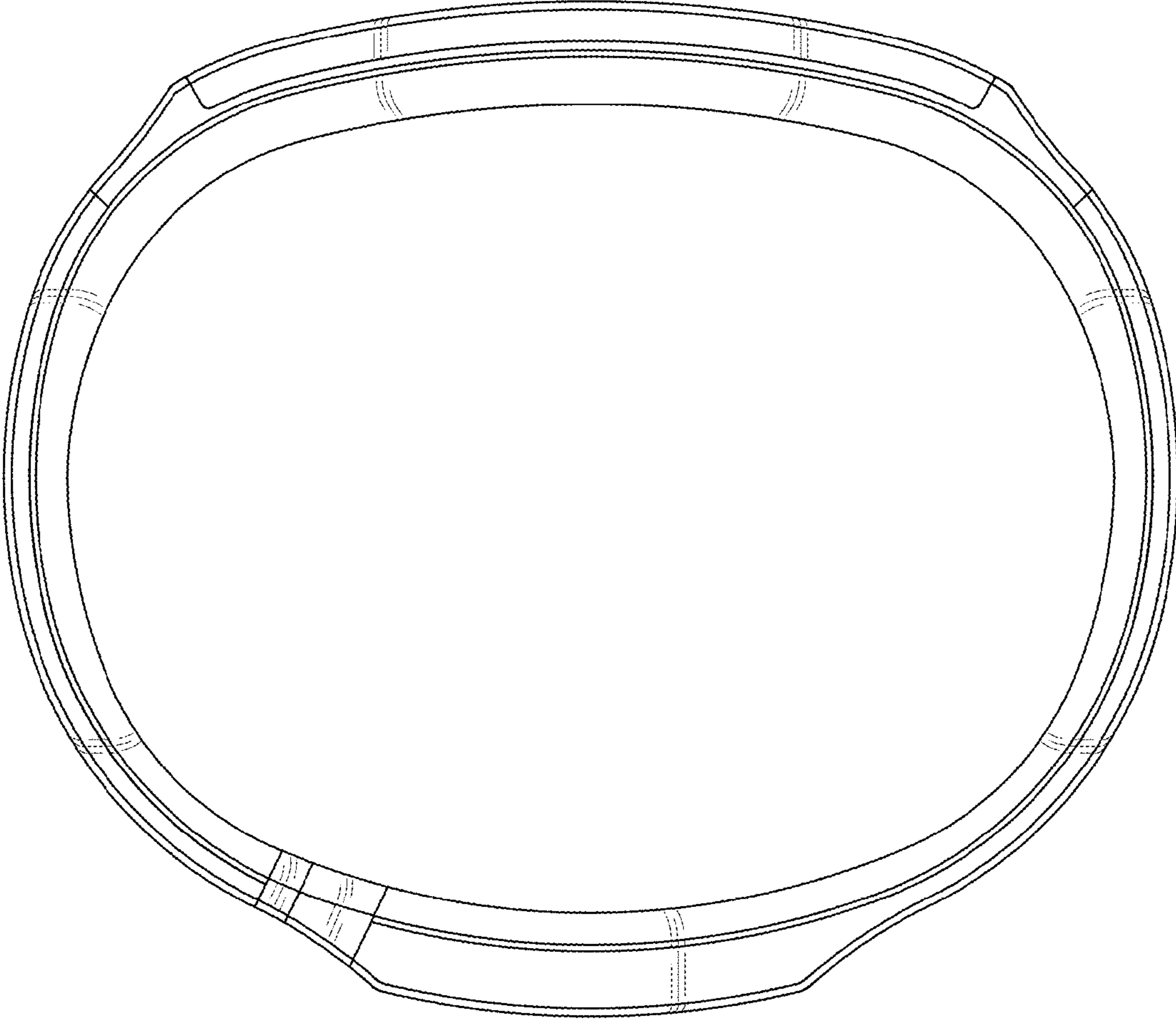

FIG. 3

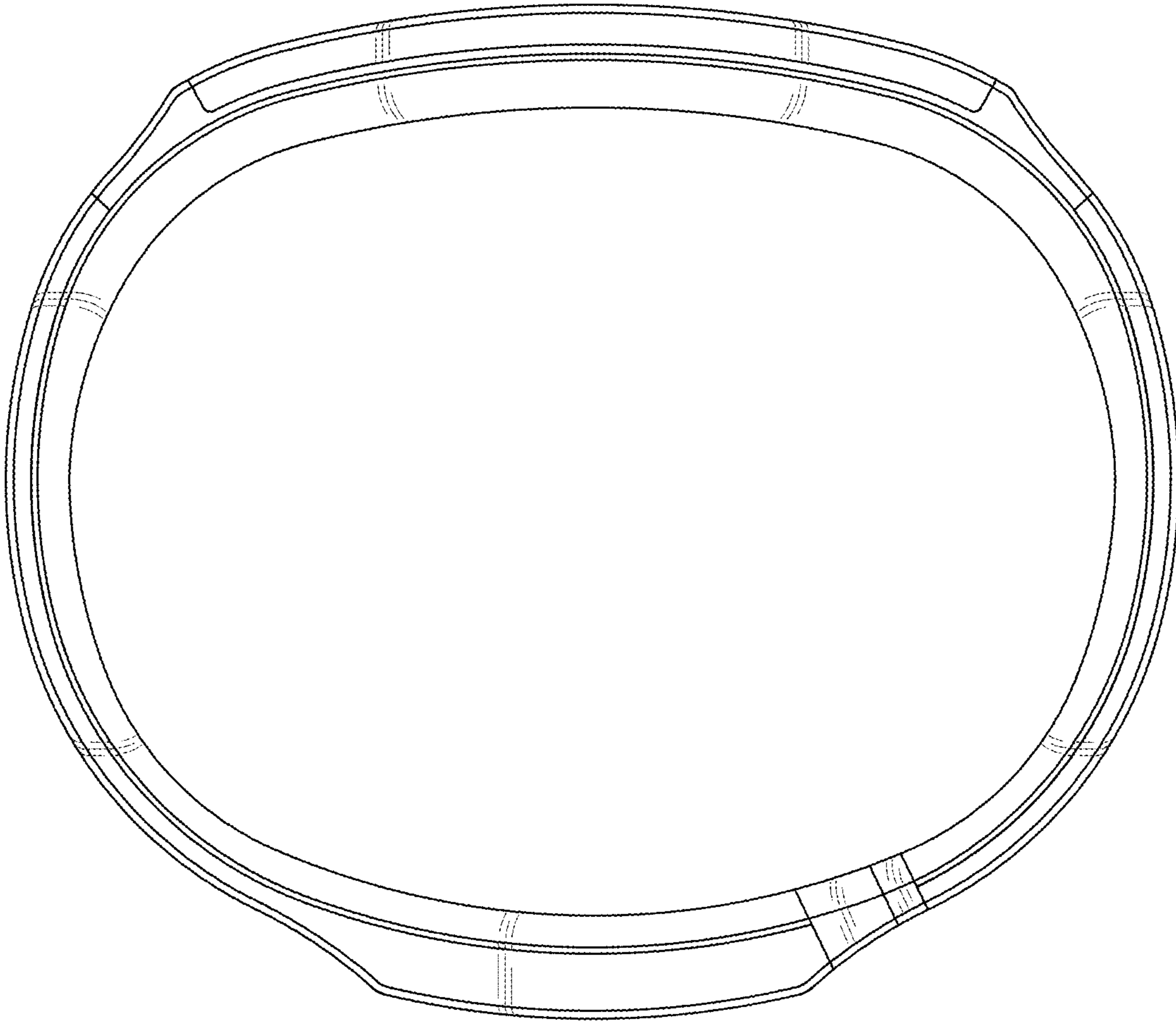

FIG. 4

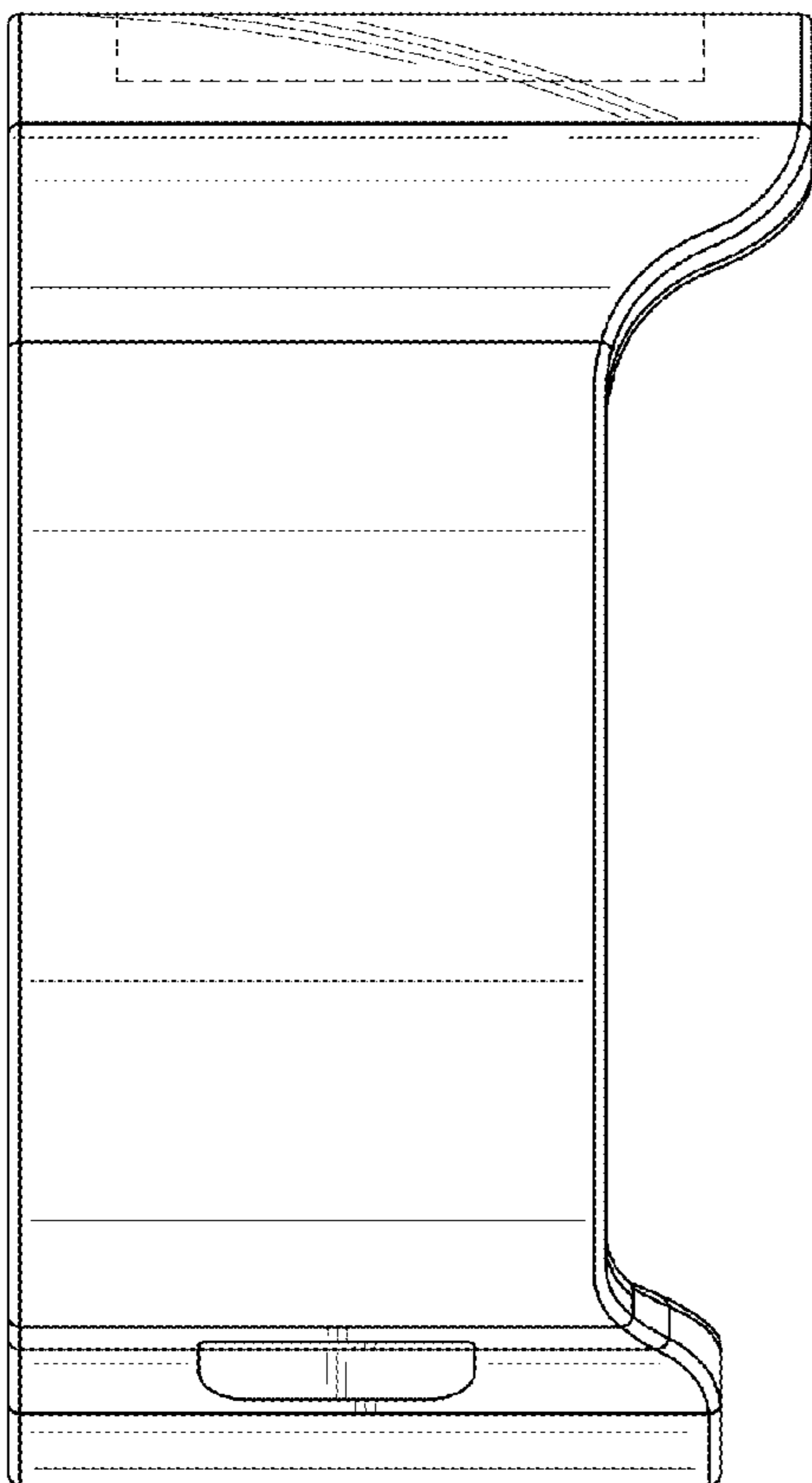

FIG. 5

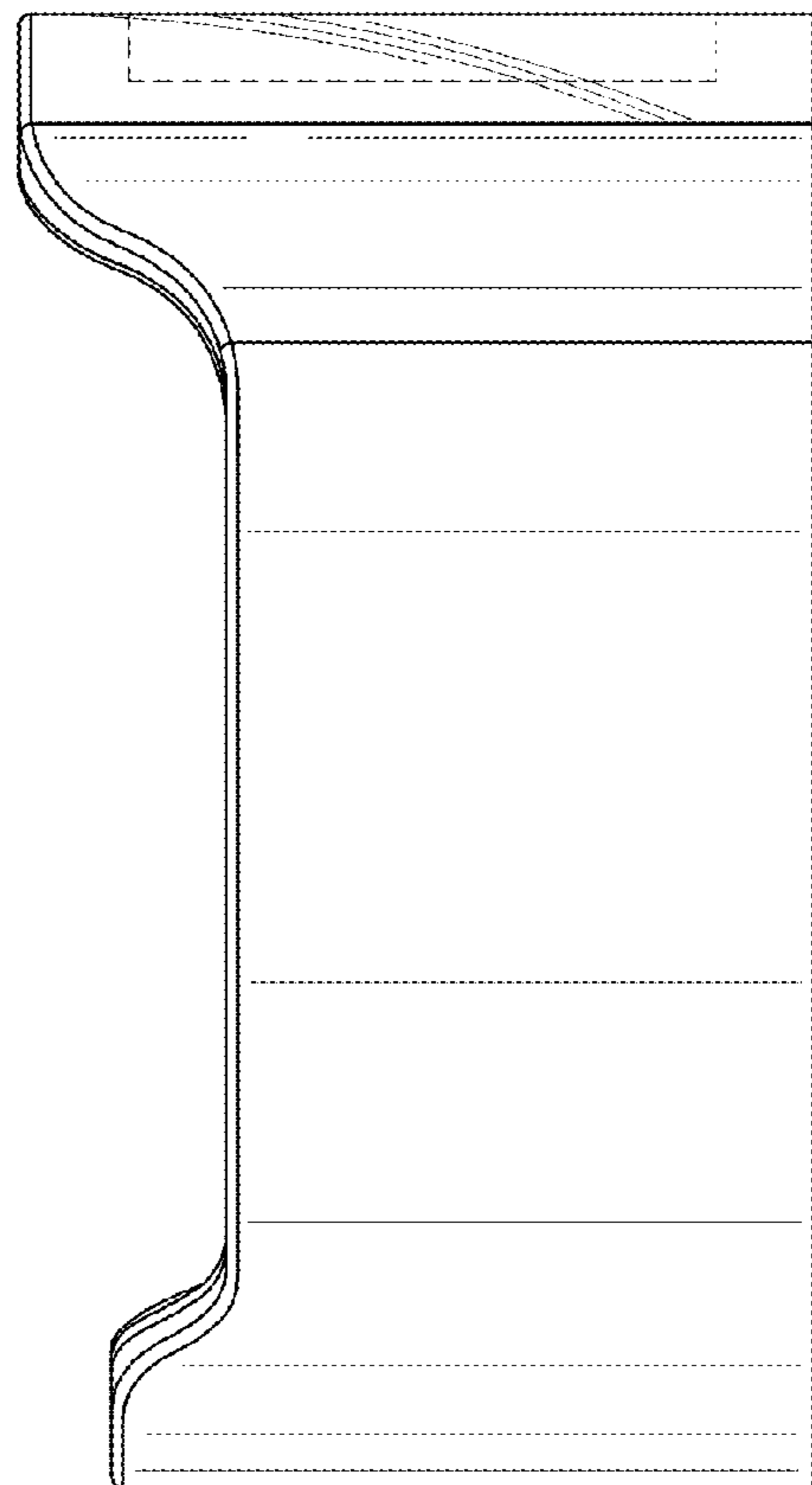

FIG. 6

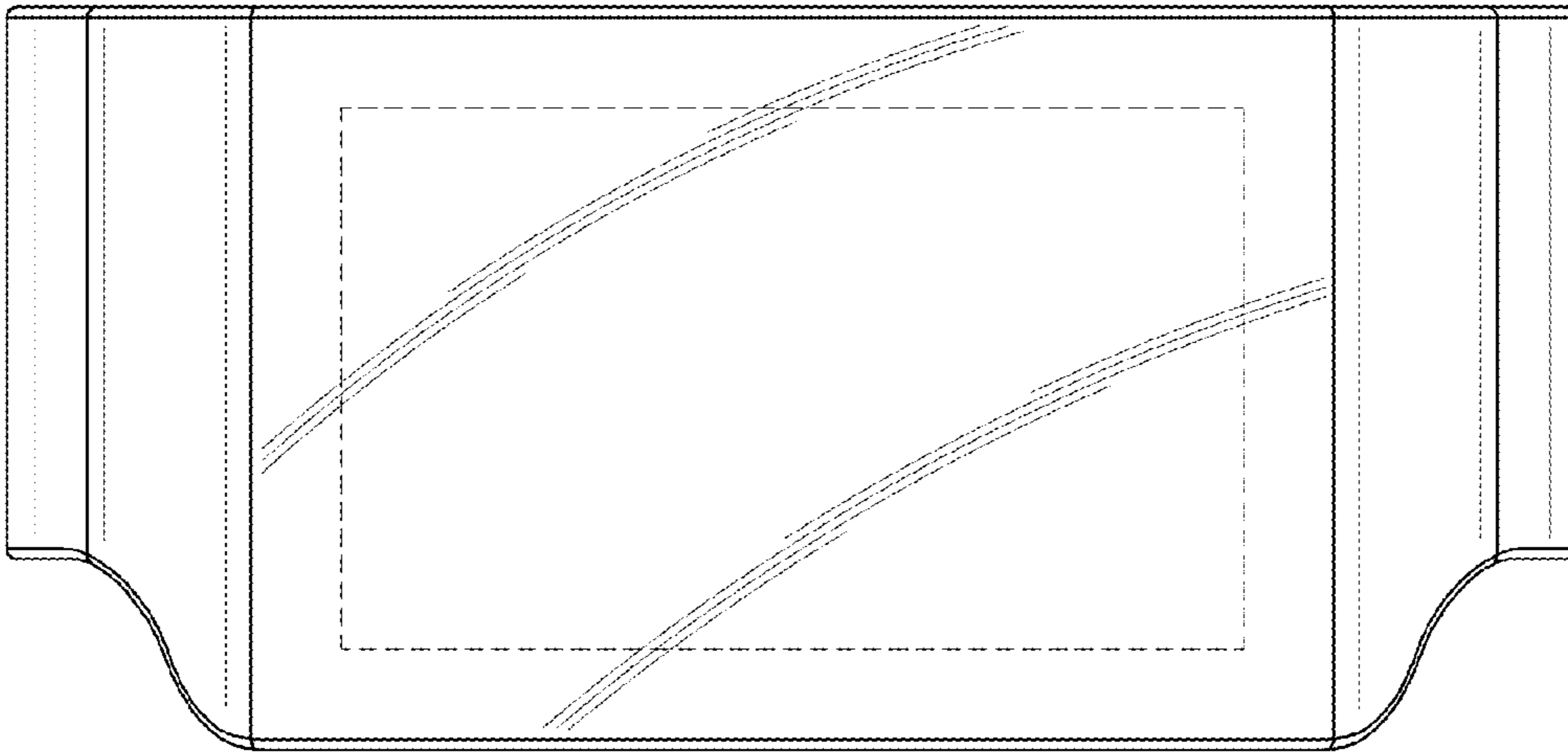

FIG. 7

