



US00D750622S

(12) **United States Design Patent**  
**Chen et al.**

(10) **Patent No.:** **US D750,622 S**  
(45) **Date of Patent:** **\*\* Mar. 1, 2016**

(54) **SMART WATCH**  
(71) Applicant: **Quanta Computer Inc.**, Taoyuan Shien (TW)  
(72) Inventors: **Chun-Yu Chen**, New Taipei (TW);  
**Shih-Yun Lee**, New Taipei (TW);  
**Jung-Wen Chang**, Taoyuan County (TW)

D564,904 S \* 3/2008 Leung ..... D10/31  
D637,918 S \* 5/2011 Cobbett et al. .... D10/31  
D638,312 S \* 5/2011 Jacobs ..... D10/32  
D724,556 S \* 3/2015 Choi et al. .... D14/138 R  
D725,497 S \* 3/2015 Henne et al. .... D10/38  
D727,198 S \* 4/2015 Akana et al. .... D11/3  
D727,759 S \* 4/2015 Martinez et al. .... D10/70  
D728,562 S \* 5/2015 Park et al. .... D14/344  
2002/0031053 A1 \* 3/2002 Nussbaum ..... 368/281

(73) Assignee: **QUANTA COMPUTER INC.**, Guishan Dist., Taoyuan (TW)

(\*\*) Term: **14 Years**

(21) Appl. No.: **29/450,339**

(22) Filed: **Mar. 17, 2013**

(30) **Foreign Application Priority Data**

Jan. 7, 2013 (TW) ..... 102300167

(51) **LOC (10) Cl.** ..... **14-02**

(52) **U.S. Cl.**  
USPC ..... **D14/344; D10/38**

(58) **Field of Classification Search**  
USPC ..... D10/15, 28, 30-32, 38, 39, 128, 132;  
D11/3, 4, 200; D14/138 R, 144, 344;  
D18/4.5; D24/187; 63/9; 224/170, 219;  
368/10, 69, 82 X, 276, 281-283, 316;  
455/575.6; 600/595  
CPC ..... A44C 5/00; G04B 37/0008  
See application file for complete search history.

(56) **References Cited**

**U.S. PATENT DOCUMENTS**

D383,985 S \* 9/1997 Davenport ..... D10/31  
D474,984 S \* 5/2003 Wilson ..... D10/37

**OTHER PUBLICATIONS**

Best Techie. Watch It: Rumors Out of Asia Speculate on iWatch in 2014, Samsung Gear Solo. Apr. 8, 2014 [online], [site visited Jun. 2, 2015]. Available from Internet, <URL:http://www.besttechie.com/2014/04/08/watch-it-rumors-out-of-asia-speculate-on-iwatch-in-2014-samsung-gear-solo/>.\*

\* cited by examiner

*Primary Examiner* — Robert M Spear

*Assistant Examiner* — Darcey E Heflin

(74) *Attorney, Agent, or Firm* — Rabin & Berdo, P.C.

(57) **CLAIM**

The ornamental design for a smart watch, as shown and described.

**DESCRIPTION**

FIG. 1 is a perspective view of a smart watch showing our new design;  
FIG. 2 is a front view thereof;  
FIG. 3 is a rear view thereof;  
FIG. 4 is a left side view thereof;  
FIG. 5 is a right side view thereof;  
FIG. 6 is a top view thereof; and,  
FIG. 7 is a bottom view thereof.  
The features shown in broken lines form no part of the claimed invention.

**1 Claim, 7 Drawing Sheets**

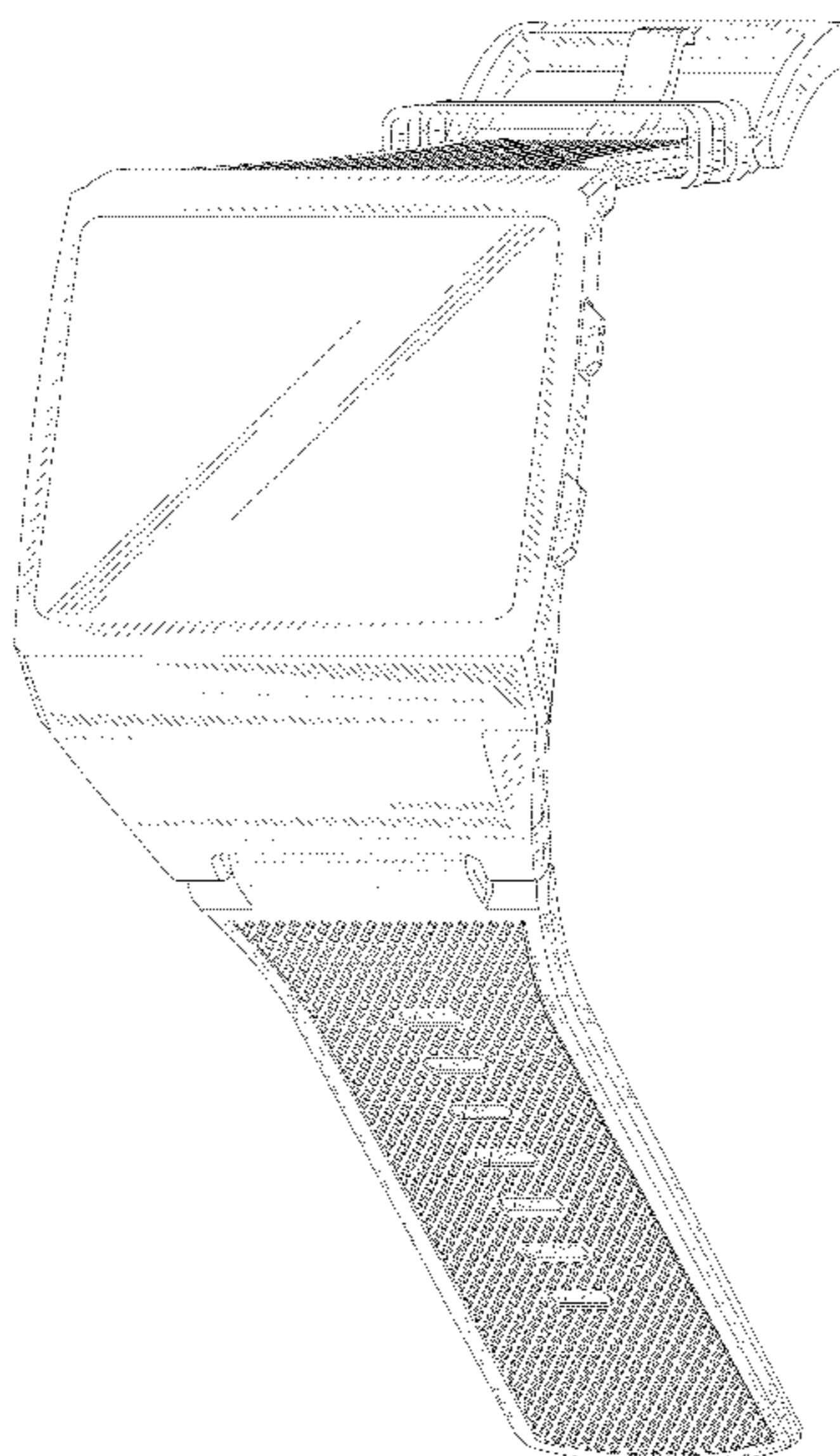

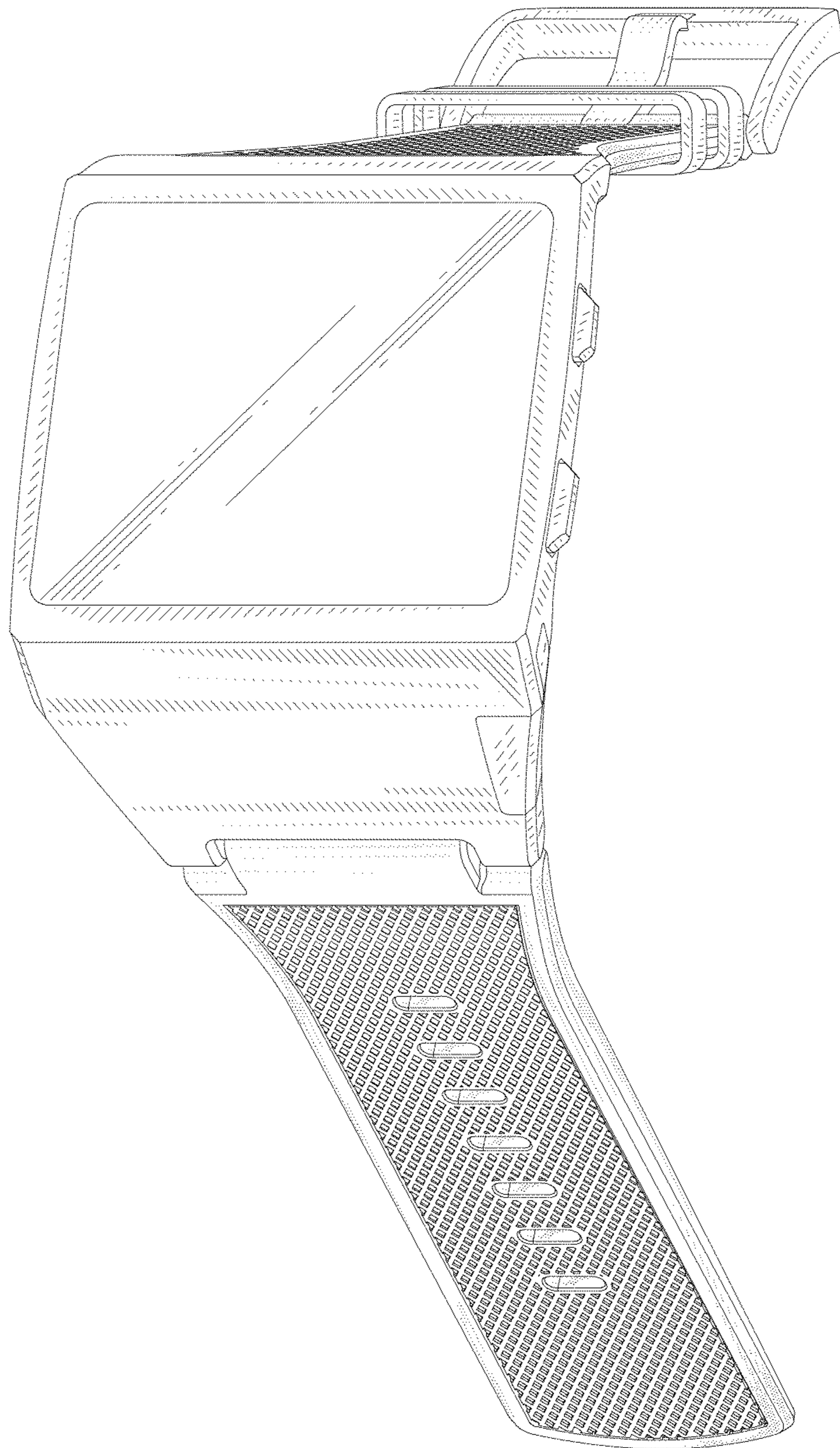

FIG. 1

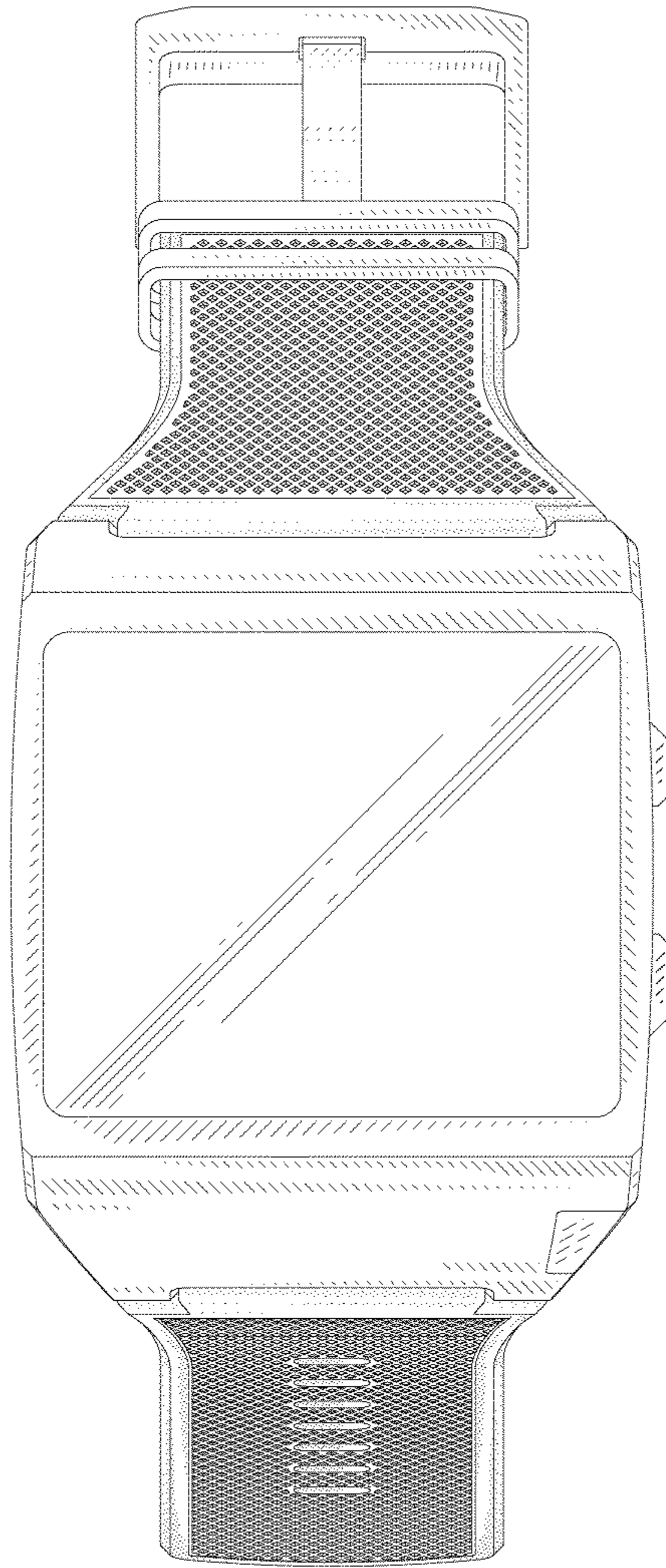

FIG. 2

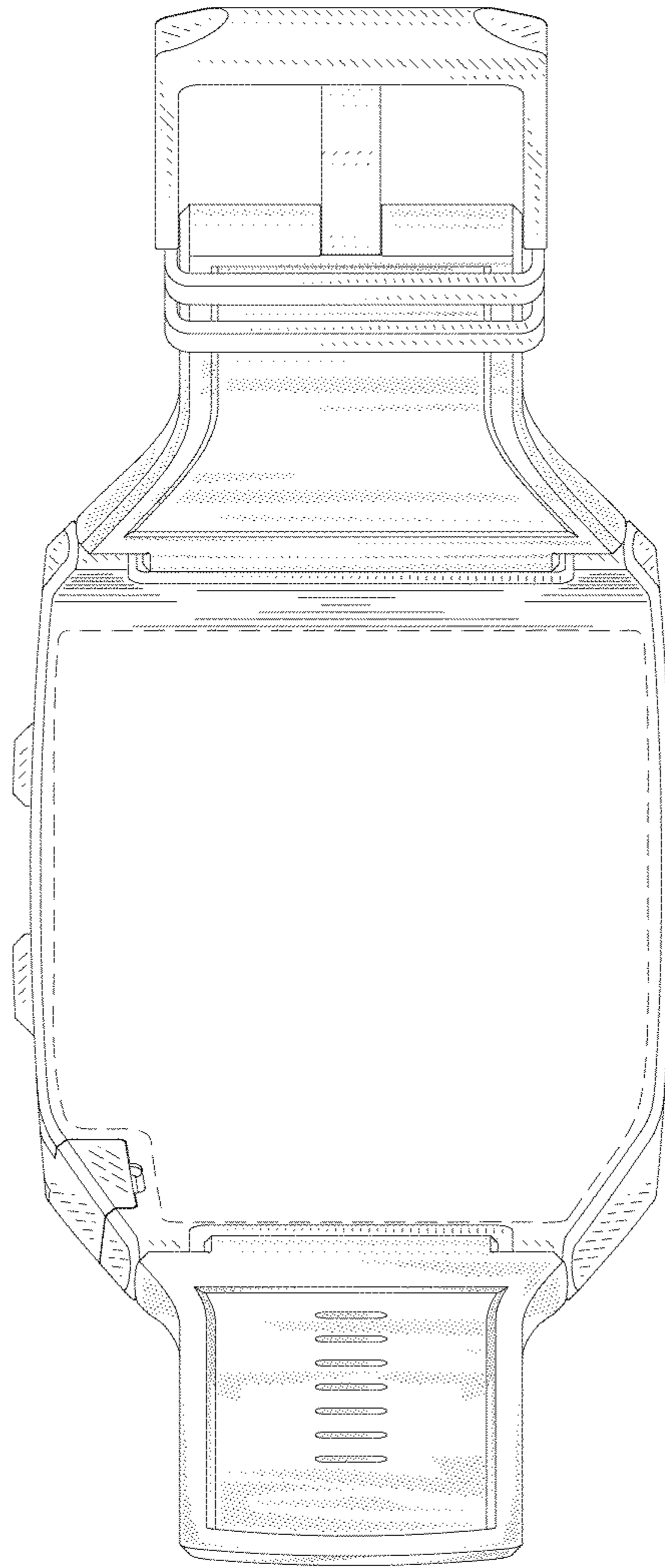

FIG. 3

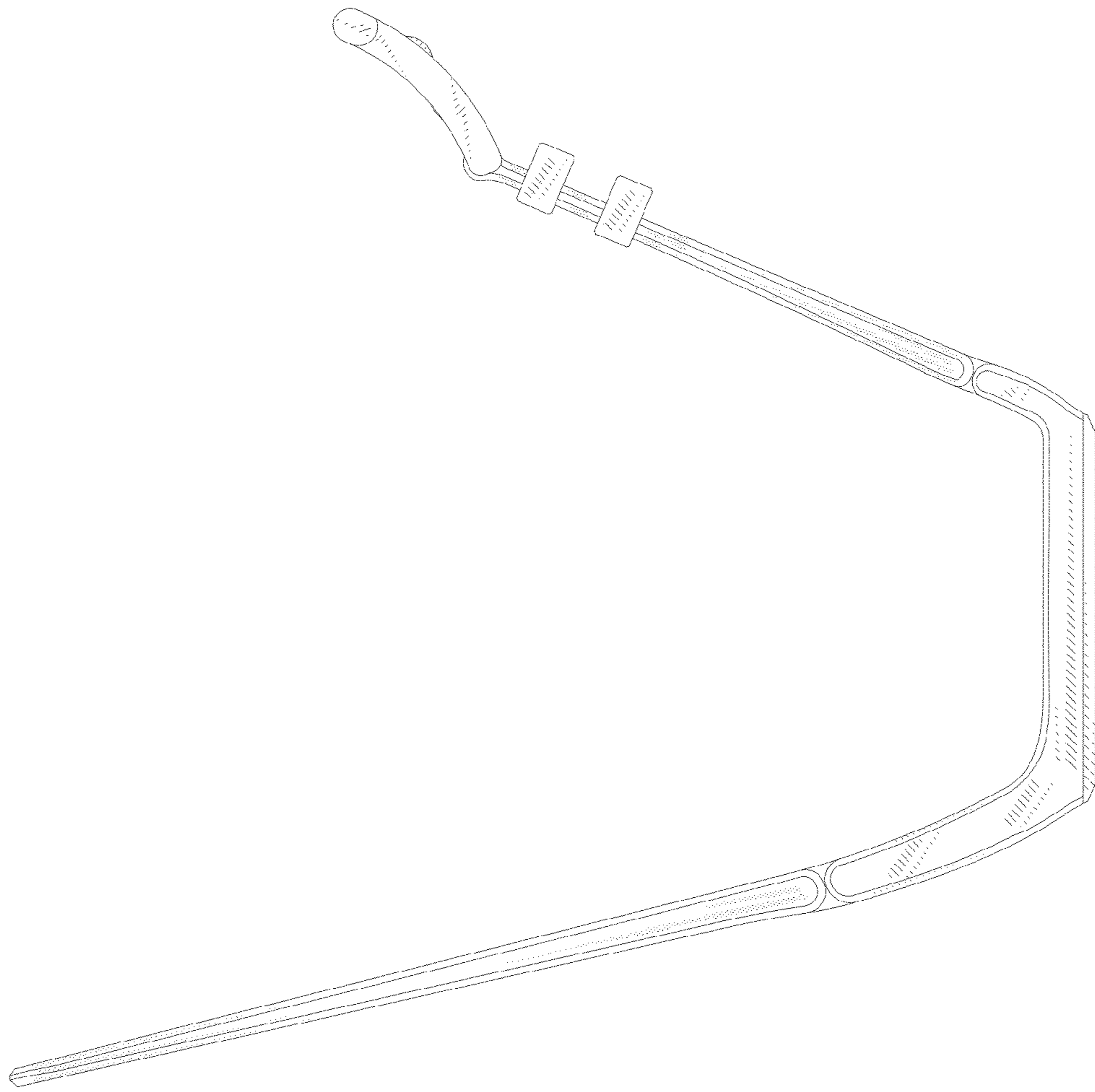

FIG. 4

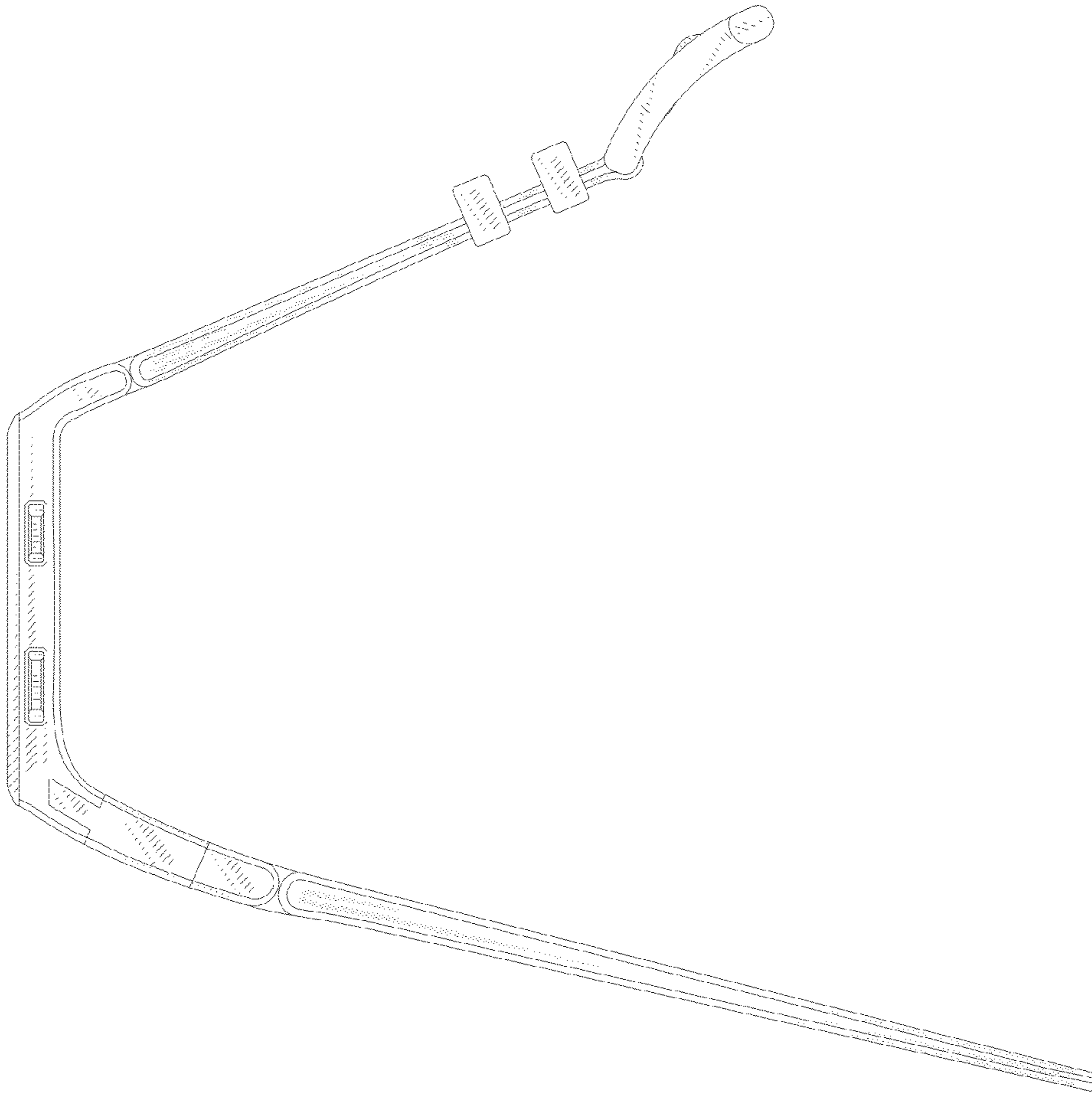

FIG. 5

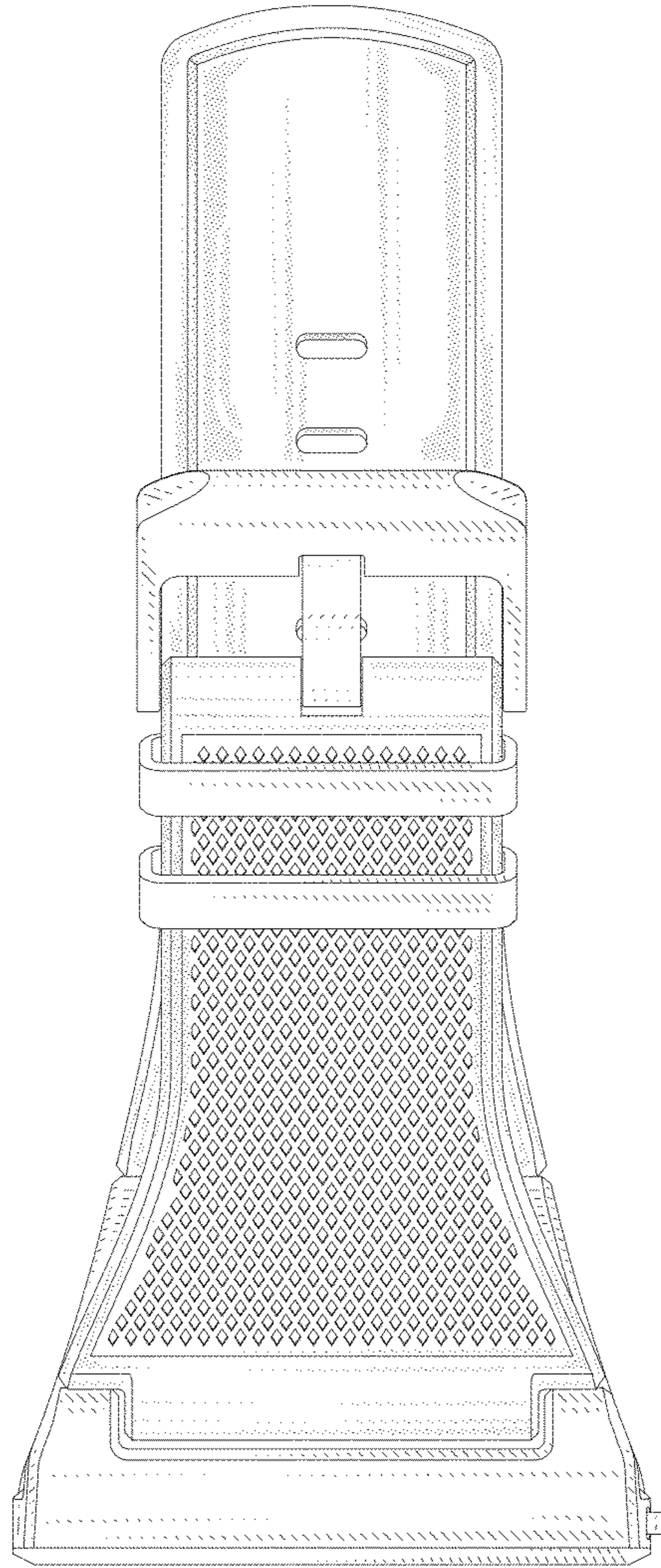

FIG. 6

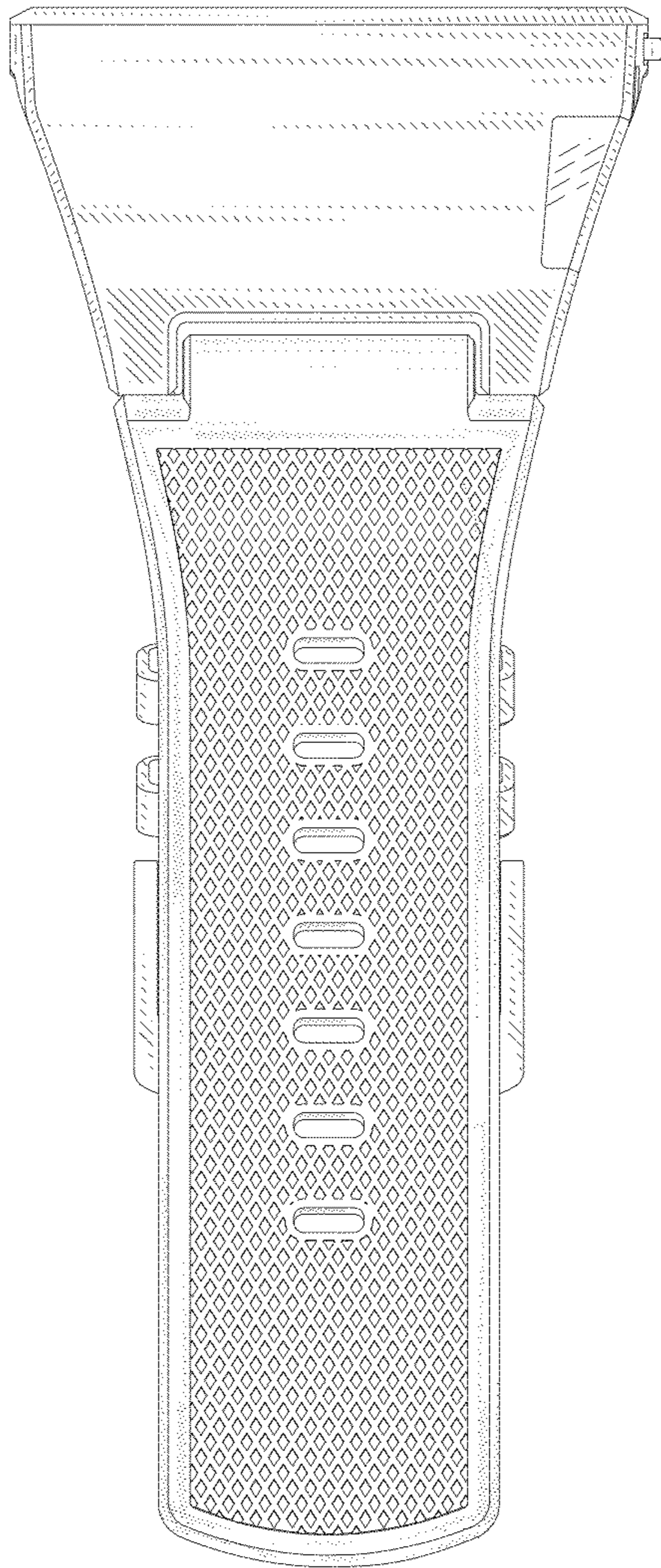

FIG. 7