

US00D750621S

(12) **United States Design Patent**
Loor Canizares et al.

(10) **Patent No.:** **US D750,621 S**
(45) **Date of Patent:** **** Mar. 1, 2016**

- (54) **TABLET COMPUTING DEVICE**
- (71) Applicant: **Amazon Technologies, Inc.**, Reno, NV (US)
- (72) Inventors: **Wilfrido Loor Canizares**, San Francisco, CA (US); **Christopher Green**, San Francisco, CA (US)
- (73) Assignee: **Amazon Technologies, Inc.**, Reno, NV (US)
- (**) Term: **14 Years**
- (21) Appl. No.: **29/501,385**
- (22) Filed: **Sep. 3, 2014**
- (51) **LOC (10) Cl.** **14-03**
- (52) **U.S. Cl.**
USPC **D14/341**; D14/203.7; D14/496
- (58) **Field of Classification Search**
USPC D14/496, 203.3, 203, 7, 341-347, D14/138 R, 138 AA, 138 C, 138 G, 218, 248; 273/148 B; 463/1, 29-35, 46, 47; 345/156, 901, 905; 379/433.04, 379/433.01, 916; 361/679.55, 679.56; 455/556.1, 556.2, 566, 575.1, 90.3
CPC . H04M 1/00; H04M 11/066; H04M 2201/38; G06F 15/00; A63F 13/00; A63F 13/09
See application file for complete search history.

D633,092	S	*	2/2011	Andre	D14/341
D644,218	S	*	8/2011	Akana	D14/250
8,248,791	B2	*	8/2012	Wang	F16M 11/10 248/188.8
D669,071	S	*	10/2012	Akana	D14/341
D671,937	S	*	12/2012	Akana	D14/341
D673,148	S	*	12/2012	Akana	D14/341
D710,352	S	*	8/2014	Lee	D14/341
D716,798	S	*	11/2014	Kurimoto	D14/341

OTHER PUBLICATIONS

Korean Office Action mailed Aug. 21, 2015 for Korean patent application No. 30/2015-10089, a counterpart foreign application of U.S. Appl. No. 29/501,385, 2 pages.
Indian Office Action mailed May 26, 2015 for Indian patent application No. 270027, a counterpart foreign application of U.S. Appl. No. 29/501,385, 27 pages.

* cited by examiner

Primary Examiner — Prabhakar Deshmukh
(74) *Attorney, Agent, or Firm* — Lee & Hayes, PLLC

(57) **CLAIM**
The ornamental design for a tablet computing device, as shown and described.

DESCRIPTION

FIG. 1 is a front perspective view of a tablet computing device showing our new design;
FIG. 2 is a rear perspective view thereof;
FIG. 3 is a front elevational view thereof;
FIG. 4 is a rear elevational view thereof;
FIG. 5 is a left side elevational view thereof;
FIG. 6 is a right side elevational view thereof;
FIG. 7 is a top plan view thereof; and,
FIG. 8 is a bottom plan view thereof.
The broken lines indicate unclaimed portions and form no part of the claimed design.

1 Claim, 6 Drawing Sheets

- (56) **References Cited**
U.S. PATENT DOCUMENTS
2,424,630 A * 7/1947 Perez B43L 5/02
33/443
7,299,580 B2 * 11/2007 Wang F16M 11/10
248/461
D599,342 S * 9/2009 Andre D14/203.7
D602,014 S * 10/2009 Andre D14/341

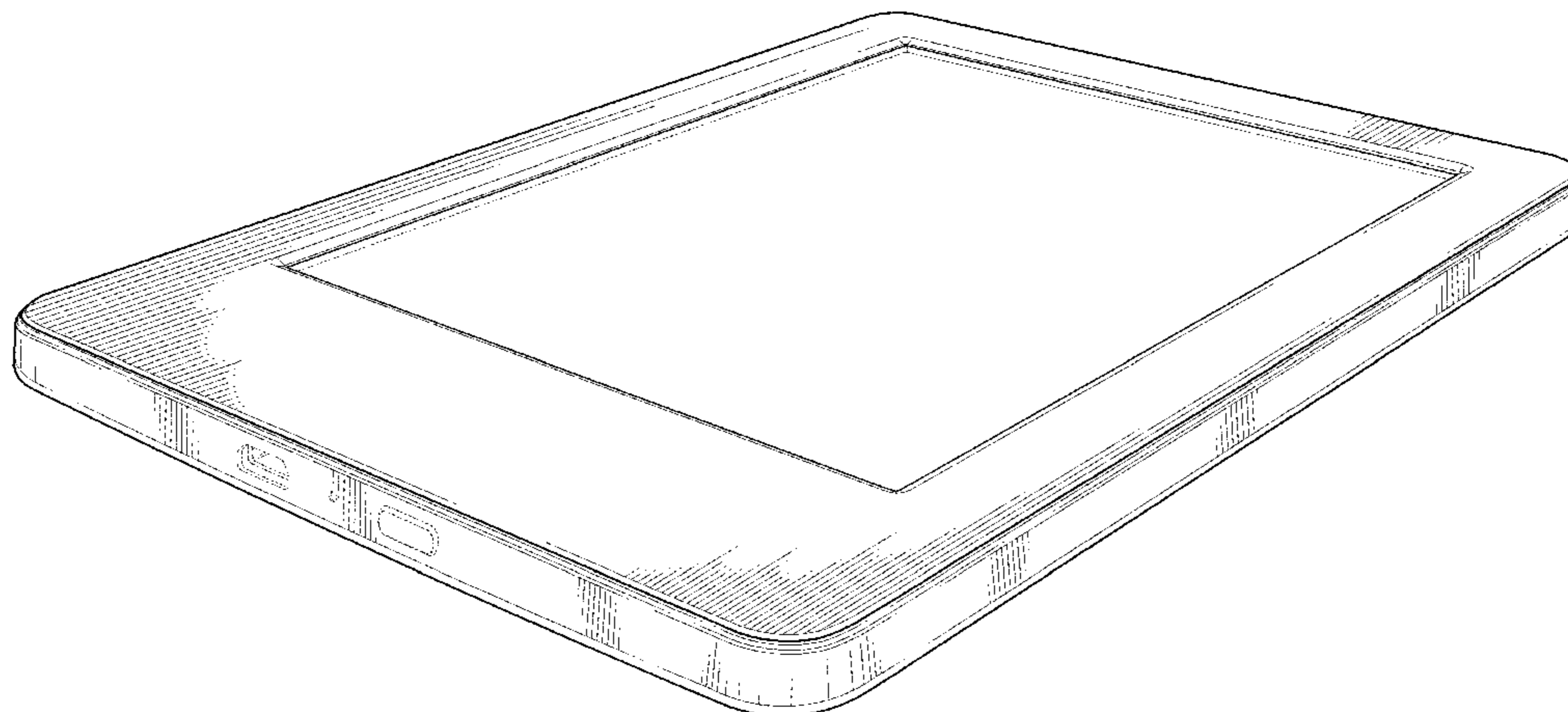

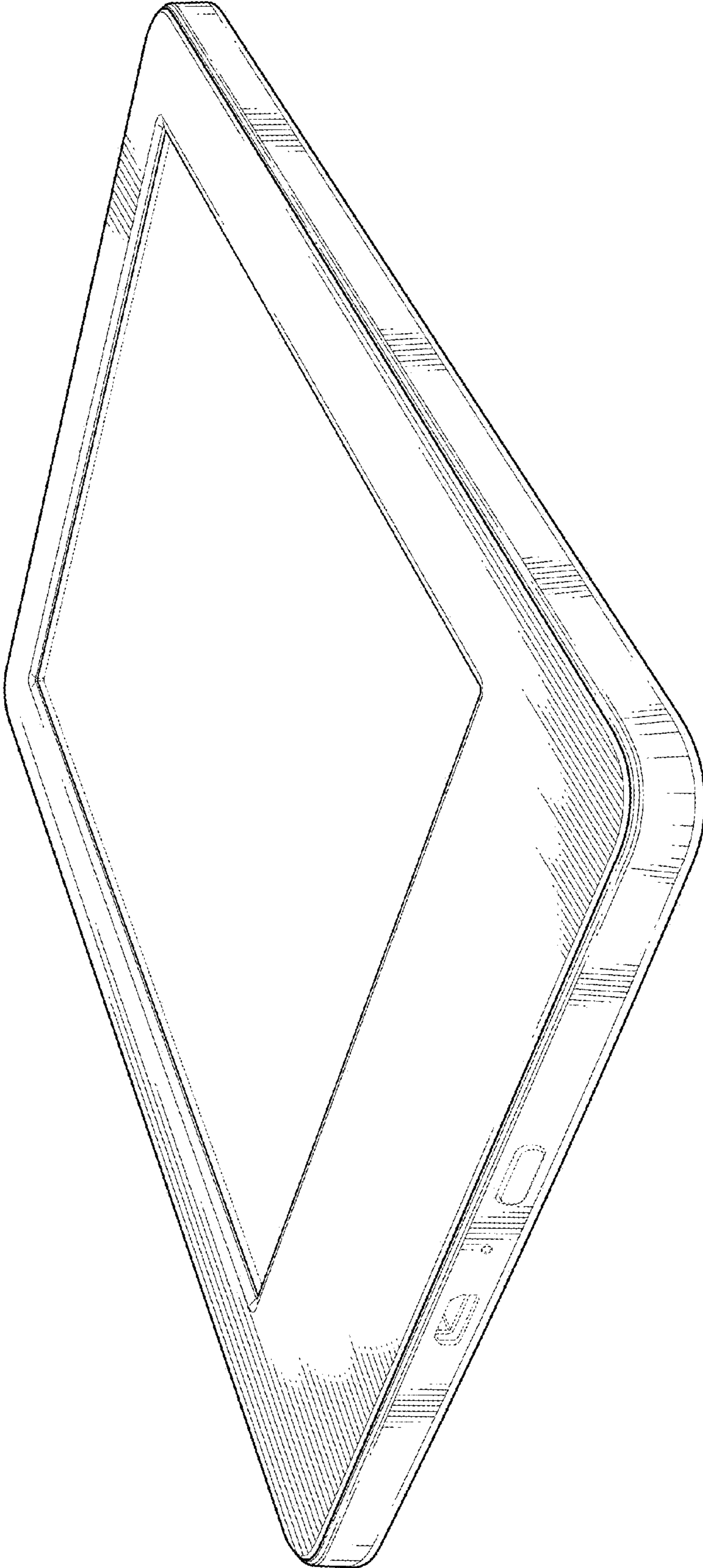

FIG. 1

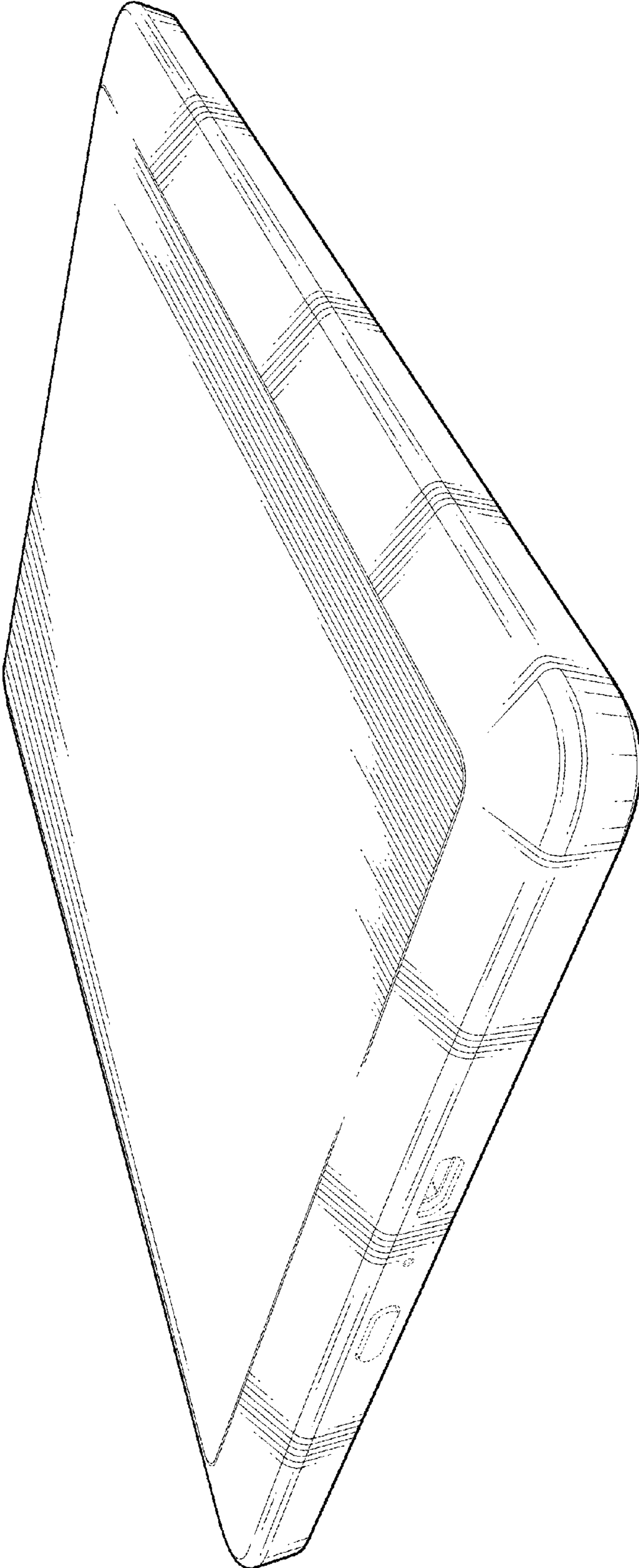

FIG. 2

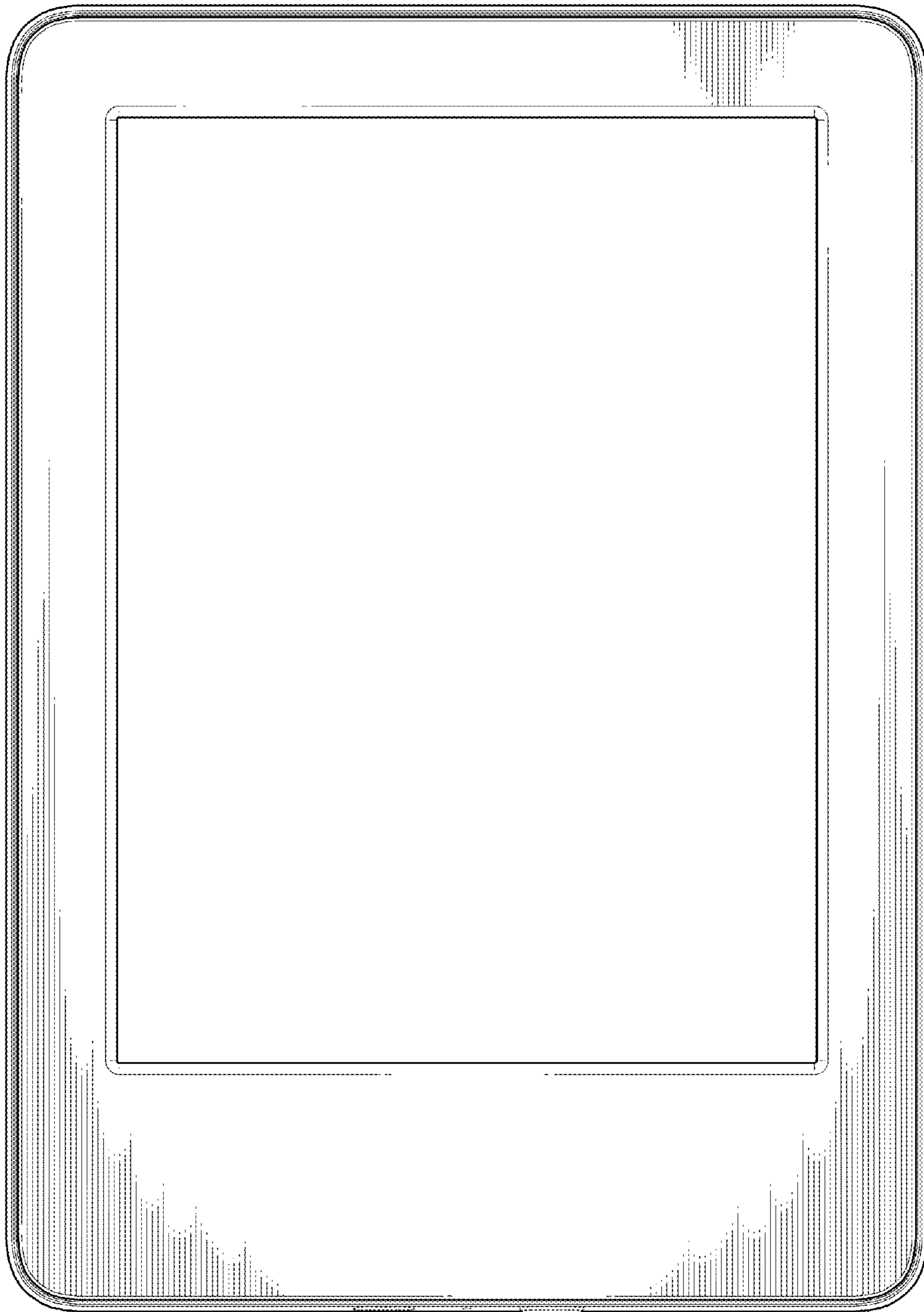

FIG. 3

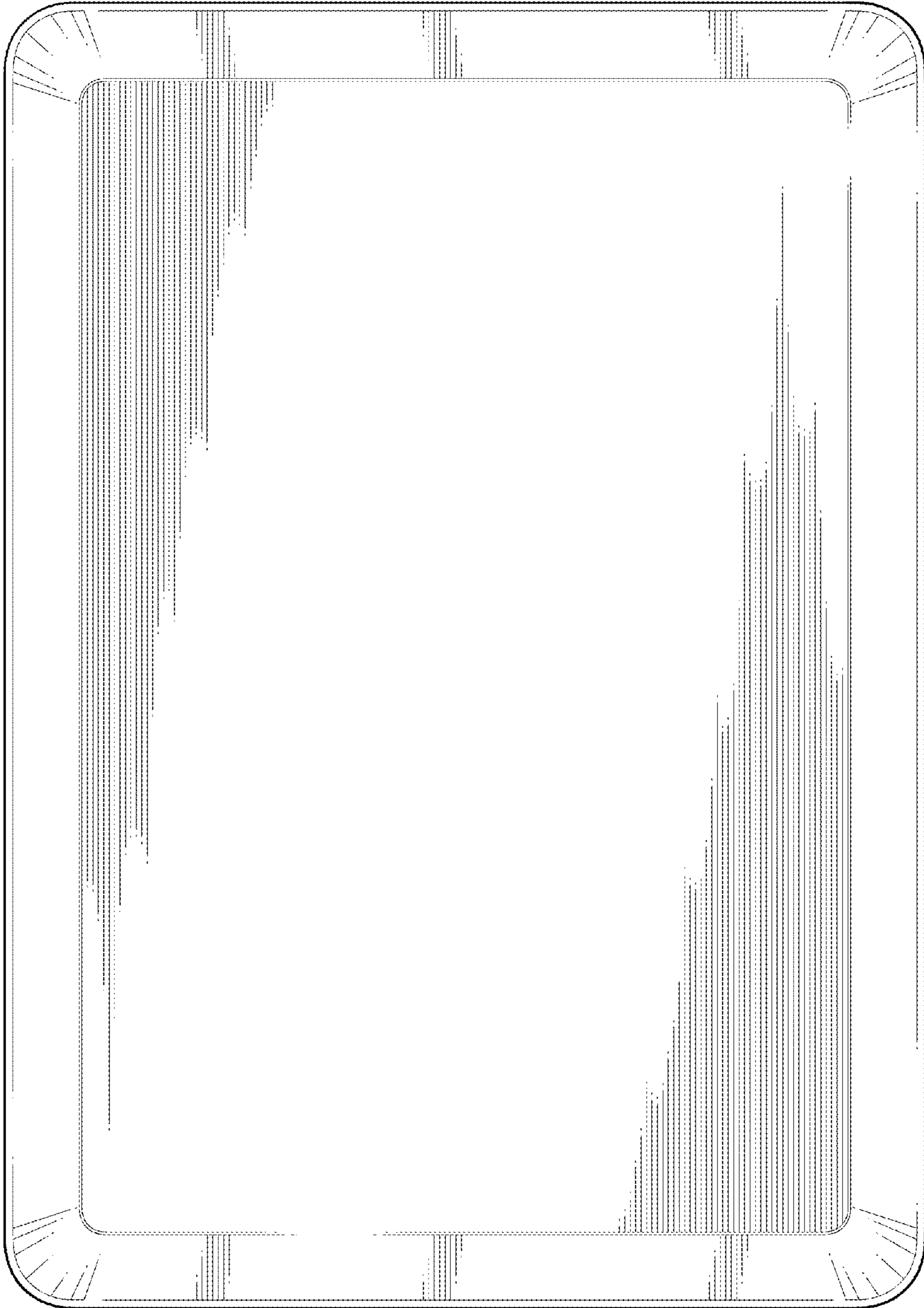

FIG. 4

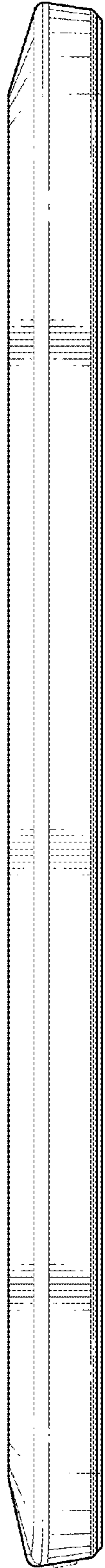

FIG. 5

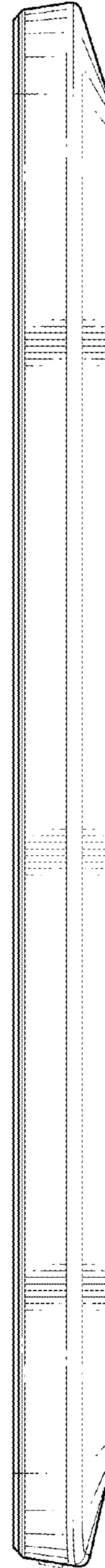

FIG. 6

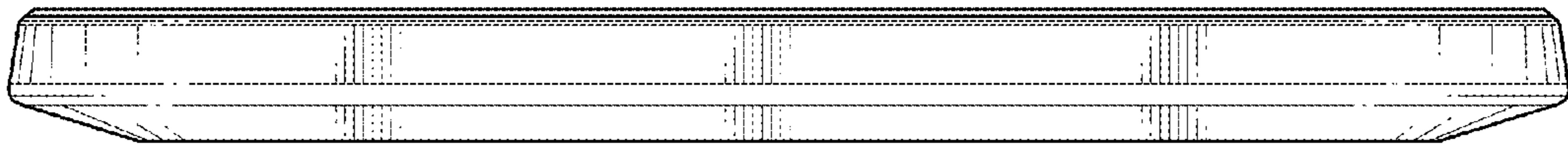

FIG. 7

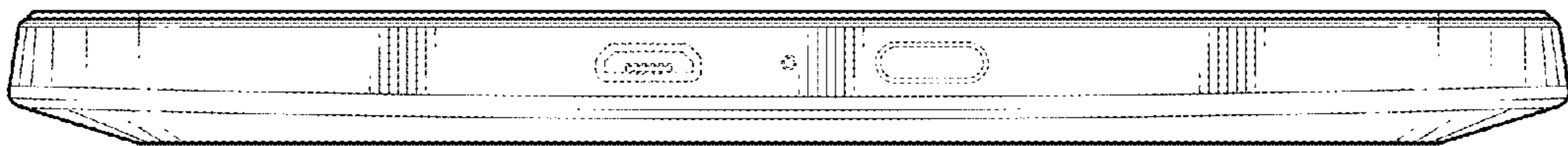

FIG. 8