



US00D750615S

(12) **United States Design Patent**
Matsuoka

(10) **Patent No.:** **US D750,615 S**
(45) **Date of Patent:** **** Mar. 1, 2016**

- (54) **NOTEBOOK COMPUTER HOUSING**
- (71) Applicant: **Google Inc.**, Mountain View, CA (US)
- (72) Inventor: **Yoshimichi Matsuoka**, Cupertino, CA (US)
- (73) Assignee: **Google Inc.**, Mountain View, CA (US)
- (**) Term: **14 Years**
- (21) Appl. No.: **29/485,664**
- (22) Filed: **Mar. 21, 2014**

6,519,139	B2	2/2003	Kambayashi
D491,177	S	6/2004	Andre et al.
D493,785	S	8/2004	Andre et al.
D516,079	S	2/2006	Solomon et al.
D572,246	S	7/2008	Andre et al.
D574,378	S	8/2008	Andre et al.

(Continued)

FOREIGN PATENT DOCUMENTS

JP	D1437328	4/2012
JP	D1395119	8/2015

OTHER PUBLICATIONS

Archived internet article.

(Continued)

Related U.S. Application Data

- (60) Division of application No. 29/468,269, filed on Sep. 27, 2013, now Pat. No. Des. 719,149, which is a continuation-in-part of application No. 29/448,147, filed on Mar. 11, 2013, now Pat. No. Des. 702,225, and a continuation-in-part of application No. 29/447,980, filed on Mar. 8, 2013, now Pat. No. Des. 711,368, and a continuation-in-part of application No. 29/447,973, filed on Mar. 8, 2013, now Pat. No. Des. 702,224.

Primary Examiner — Freda S Nunn

(74) *Attorney, Agent, or Firm* — Lerner, David, Littenberg, Krumholz & Mentlik, LLP

- (51) **LOC (10) Cl.** **14-02**
- (52) **U.S. Cl.**
USPC **D14/315**

(57) **CLAIM**

The ornamental design for a notebook computer housing, as shown and described.

- (58) **Field of Classification Search**
USPC D14/315–327; D18/1, 2, 7, 11; 235/145 A, 145 R; 341/22, 23; 345/104, 345/156, 168, 169, 173; 361/679.08, 361/679.09, 679.11, 679.26, 679.27
CPC G06F 1/16; G06F 1/1616; H01R 35/02; H03M 11/00; G09B 13/04; H03K 17/94
See application file for complete search history.

DESCRIPTION

FIG. 1 is a front perspective view of a notebook computer housing according to my design;
 FIG. 2 is a front view thereof;
 FIG. 3 is a back view thereof;
 FIG. 4 is an enlarged view of the area indicated in FIG. 3 thereof;
 FIG. 5 is a right side view thereof;
 FIG. 6 is a left side view thereof;
 FIG. 7 is a top view thereof; and,
 FIG. 8 is a bottom view thereof.
 Broken lines are environmental only and form no part of the claimed design.

- (56) **References Cited**
U.S. PATENT DOCUMENTS

5,987,704	A	11/1999	Tang
6,067,224	A	5/2000	Nobuchi
D464,344	S	10/2002	Jobs et al.

1 Claim, 8 Drawing Sheets

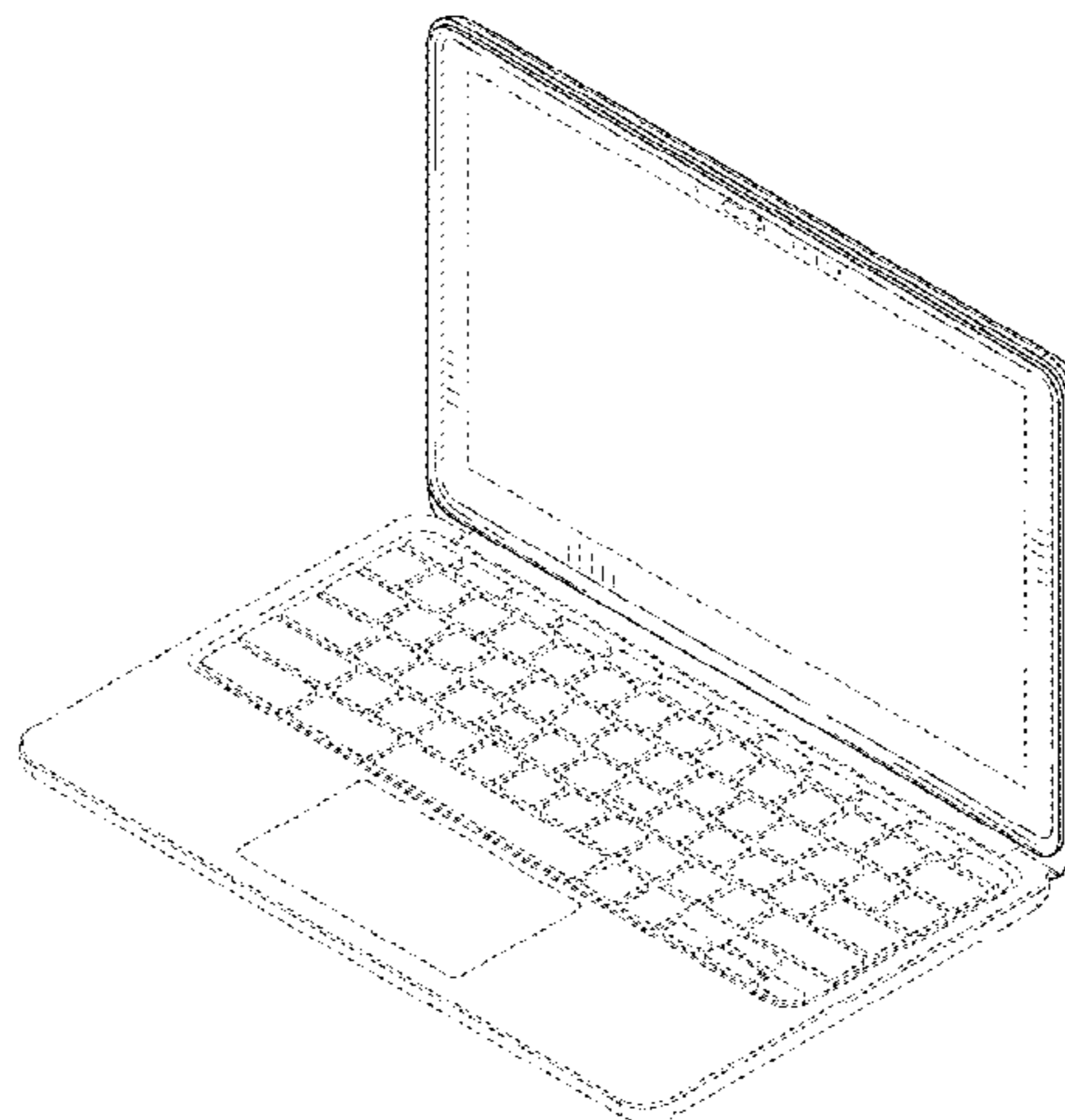

(56)

References Cited

U.S. PATENT DOCUMENTS

D603,393 S 11/2009 Paek
 D605,192 S 12/2009 Lin
 D606,534 S 12/2009 Hong et al.
 D612,843 S 3/2010 Andre et al.
 D612,844 S 3/2010 Andre et al.
 7,679,901 B2 3/2010 Lin
 D614,180 S 4/2010 Gou
 7,715,190 B2 5/2010 Tang
 D616,880 S 6/2010 Andre et al.
 D617,789 S 6/2010 Akana et al.
 D621,409 S 8/2010 Andre et al.
 D621,824 S 8/2010 Andre et al.
 7,778,016 B2 8/2010 Minaguchi et al.
 D624,911 S 10/2010 Lee et al.
 D626,546 S 11/2010 Paek
 7,855,876 B2 12/2010 Zhu et al.
 D631,472 S 1/2011 Kawase et al.
 D633,488 S 3/2011 Kim et al.
 D633,907 S 3/2011 Andre et al.
 7,903,398 B2 3/2011 Carr et al.
 D635,575 S 4/2011 Masui et al.
 D636,389 S 4/2011 Akana et al.
 7,944,684 B2 5/2011 Yu
 D642,172 S 7/2011 Akana et al.
 D642,560 S 8/2011 Akana et al.
 7,990,703 B2 8/2011 Tang
 8,085,533 B2 12/2011 Zhao et al.
 D651,598 S 1/2012 Kim et al.
 D652,417 S 1/2012 Lee et al.
 D664,537 S 7/2012 Hu et al.
 D665,800 S 8/2012 Hsu et al.
 8,289,688 B2 10/2012 Behar et al.
 D671,536 S 11/2012 Fukusawa et al.
 D671,936 S 12/2012 Fong et al.

8,330,725 B2 12/2012 Mahowald et al.
 D673,559 S 1/2013 Yang et al.
 D675,199 S 1/2013 Wen et al.
 D675,200 S 1/2013 Liu et al.
 D675,611 S 2/2013 Wen et al.
 D676,042 S 2/2013 McManigal et al.
 8,373,977 B2 2/2013 Shao et al.
 D677,656 S 3/2013 Ashcraft et al.
 D678,872 S 3/2013 Lee et al.
 D679,704 S 4/2013 McManigal et al.
 D679,705 S 4/2013 McManigal et al.
 D680,117 S 4/2013 Ho
 D681,628 S 5/2013 Lin et al.
 D682,818 S 5/2013 Morisawa
 D682,828 S 5/2013 Kim et al.
 D683,343 S 5/2013 Wen et al.
 D683,344 S 5/2013 Kao et al.
 D683,726 S 6/2013 Morisawa
 D684,965 S 6/2013 Lam et al.
 D684,966 S 6/2013 Lam et al.
 D685,368 S 7/2013 Lam et al.
 D686,203 S 7/2013 Lee et al.
 D686,613 S 7/2013 Bowers et al.
 D688,238 S 8/2013 Hsu et al.
 8,508,936 B2 8/2013 Chen et al.
 8,537,541 B2 9/2013 Zhang
 D719,149 S * 12/2014 Matsuoka D14/318
 2002/0089819 A1 * 7/2002 Misawa et al. 361/683
 2005/0041378 A1 2/2005 Hamada et al.
 2009/0115927 A1 5/2009 Chang
 2013/0010417 A1 1/2013 Huang et al.

OTHER PUBLICATIONS

Japanese Search Report for Application No. 103305318 dated Jun. 24, 2015.

* cited by examiner

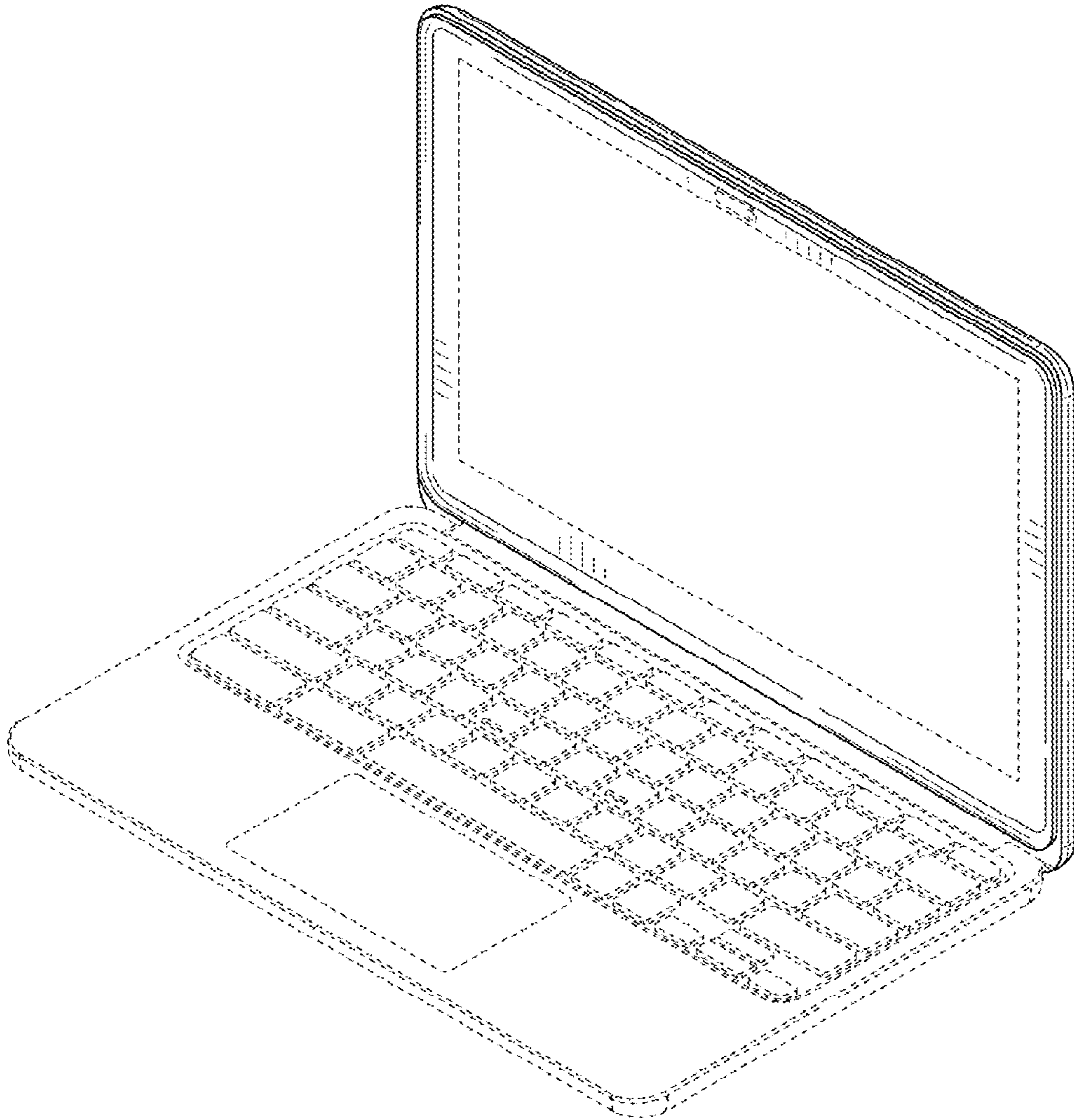

FIG. 1

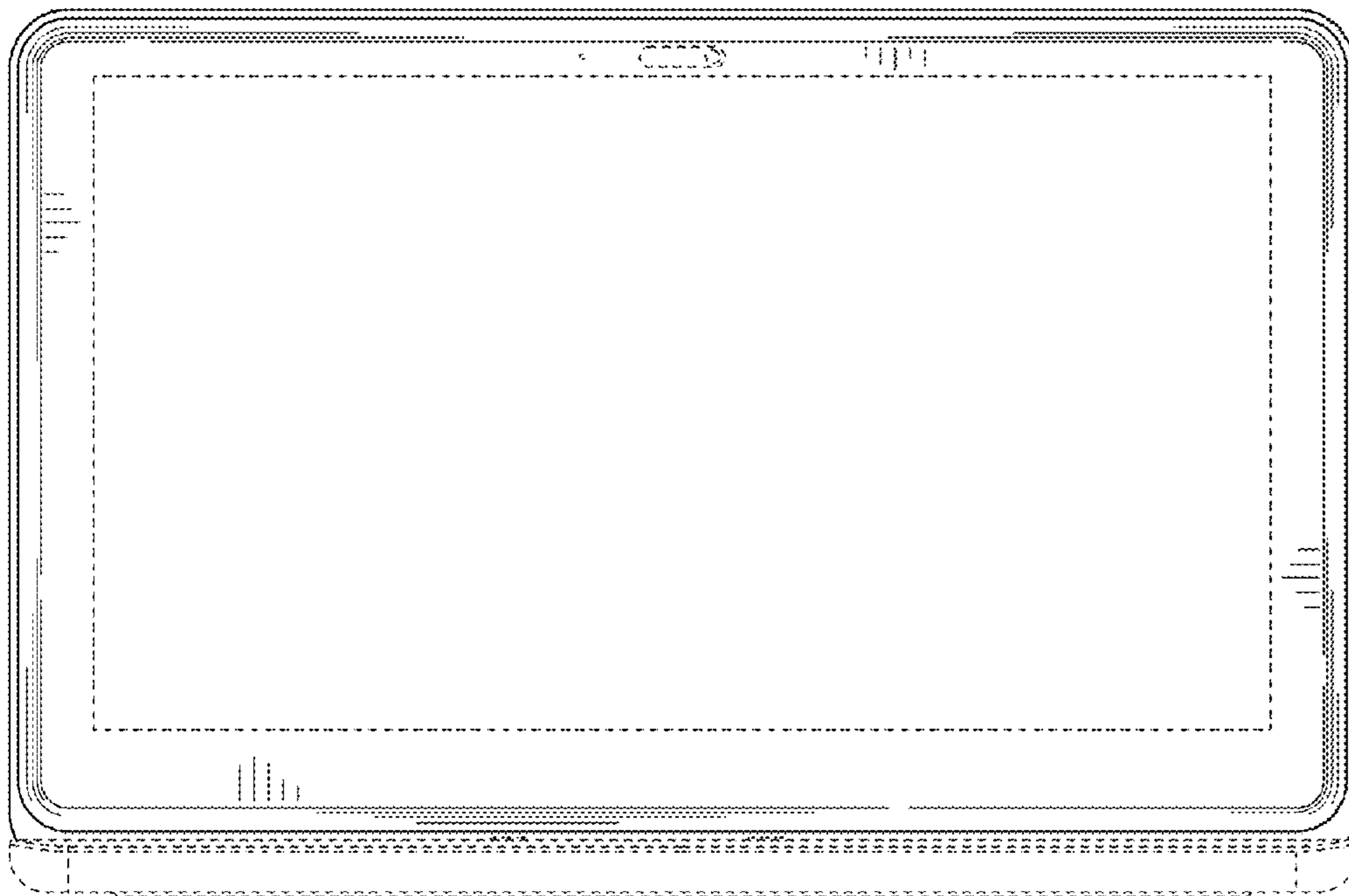

FIG. 2

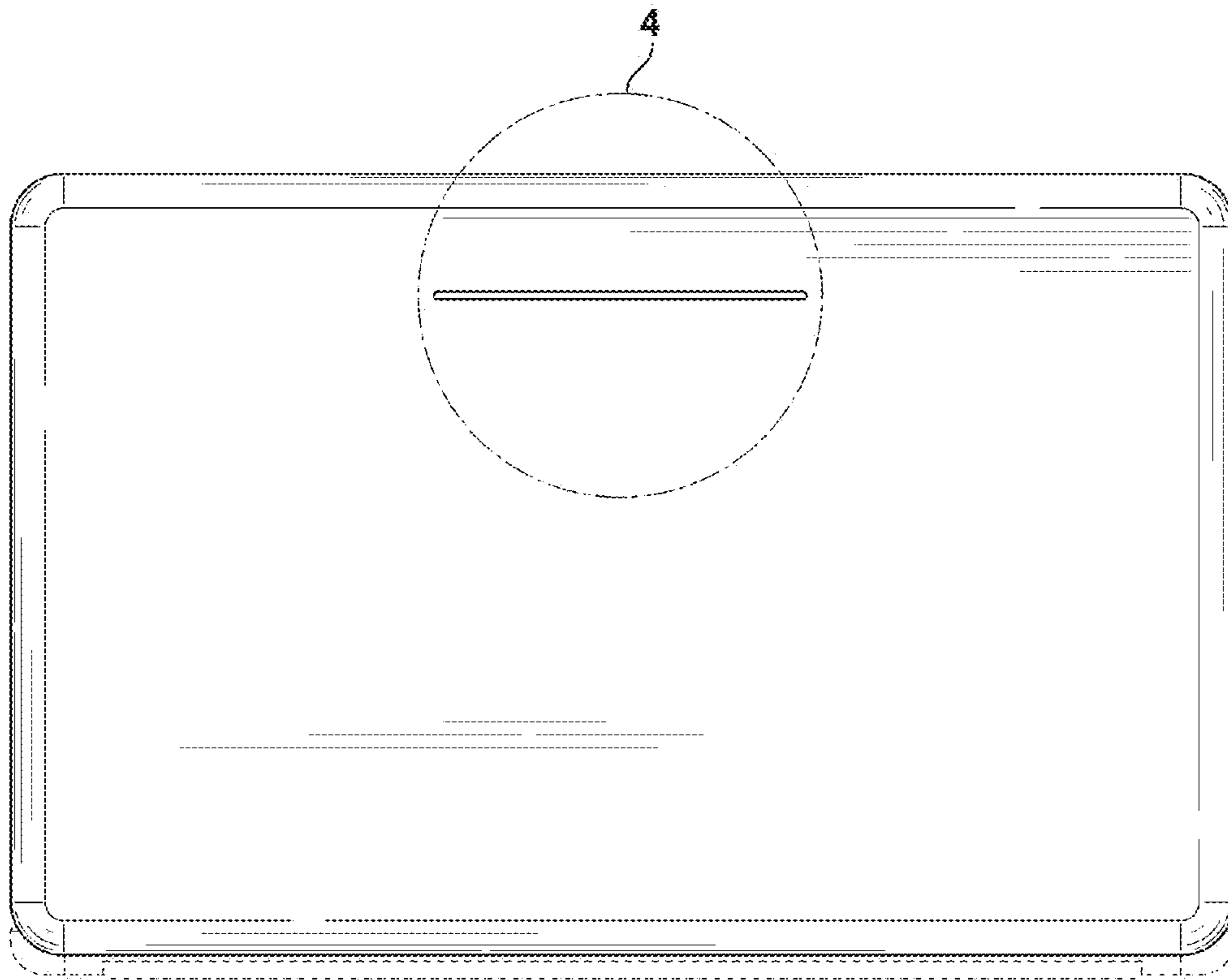

FIG. 3

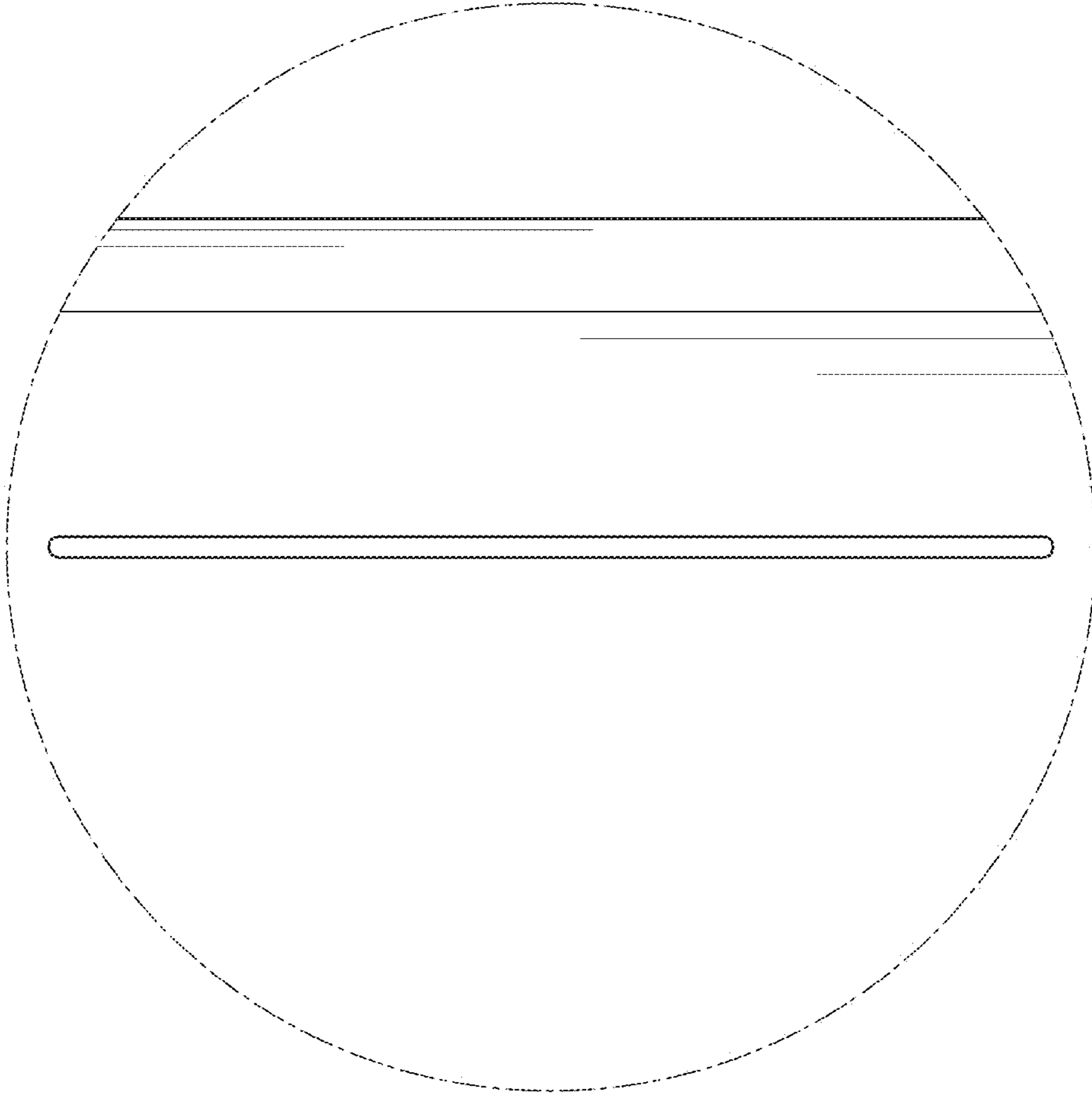

FIG. 4

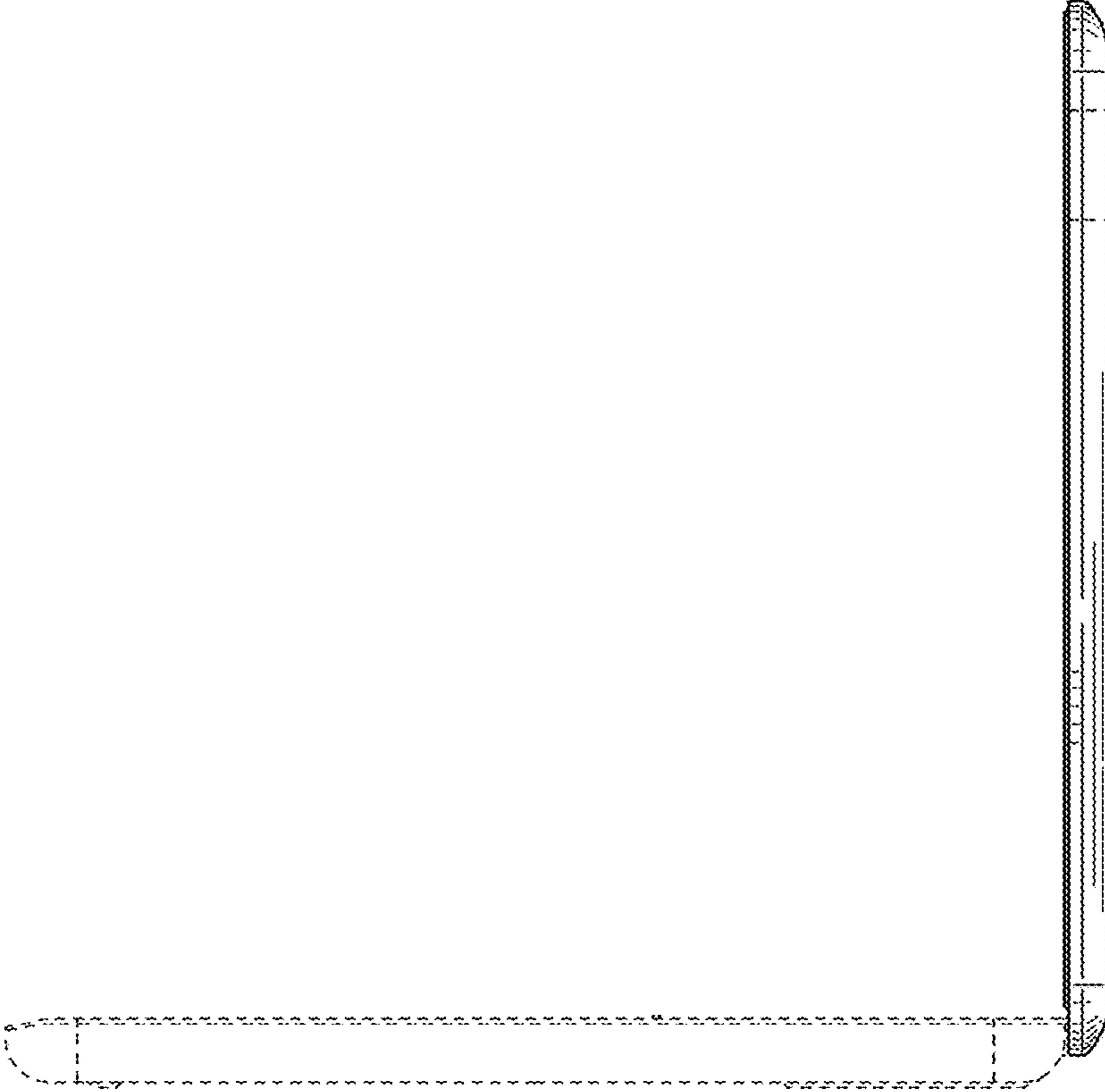

FIG. 5

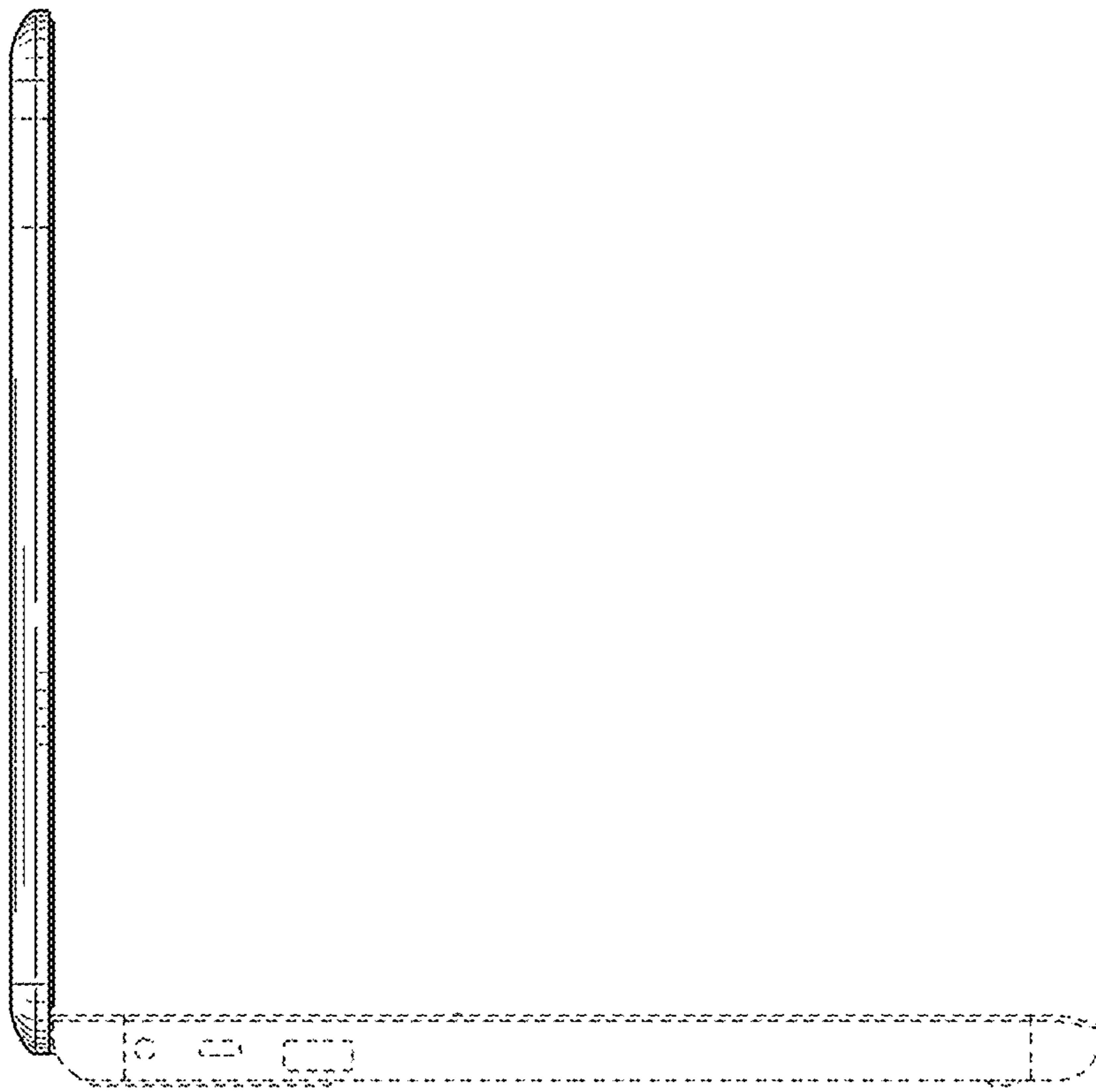

FIG. 6

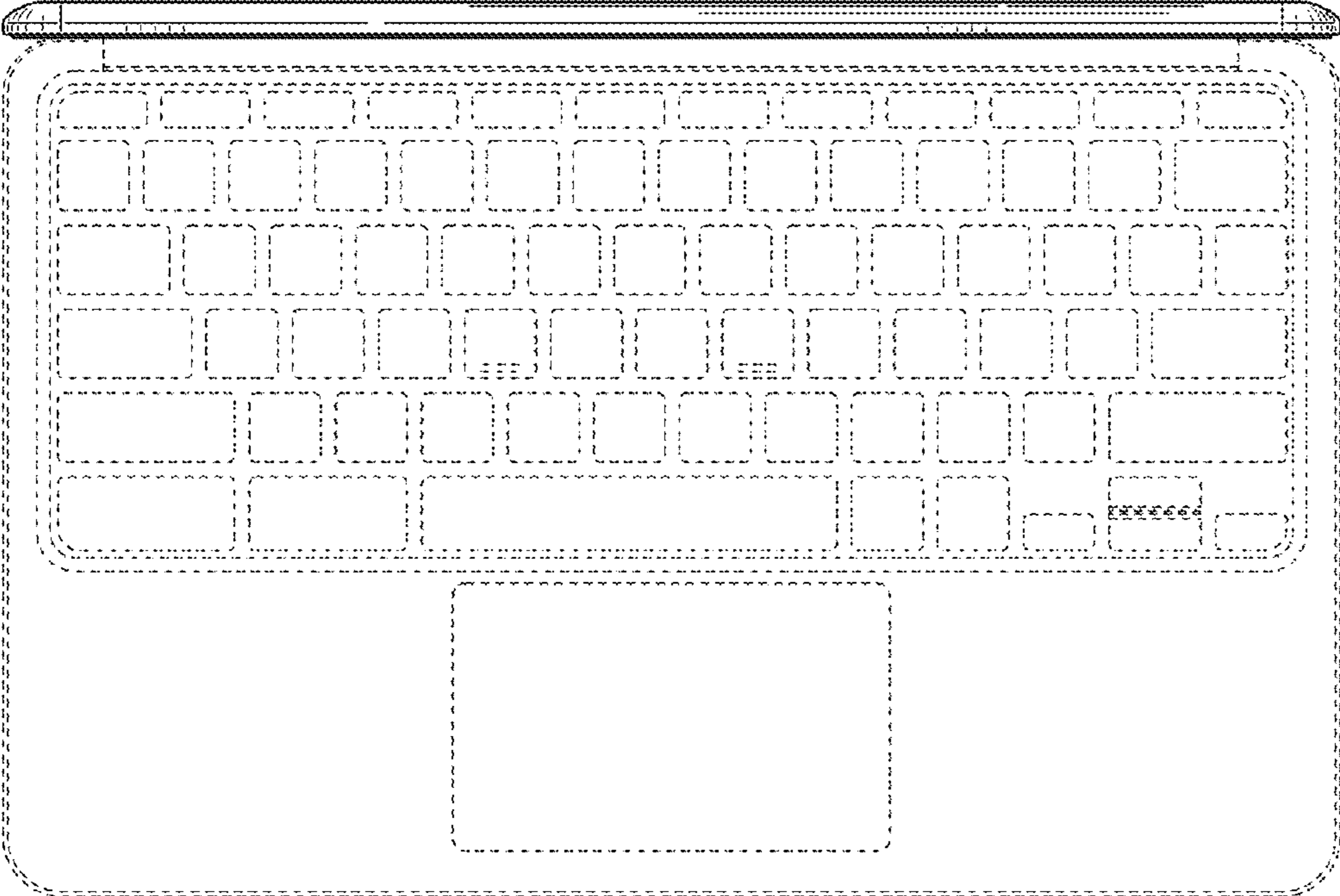

FIG. 7

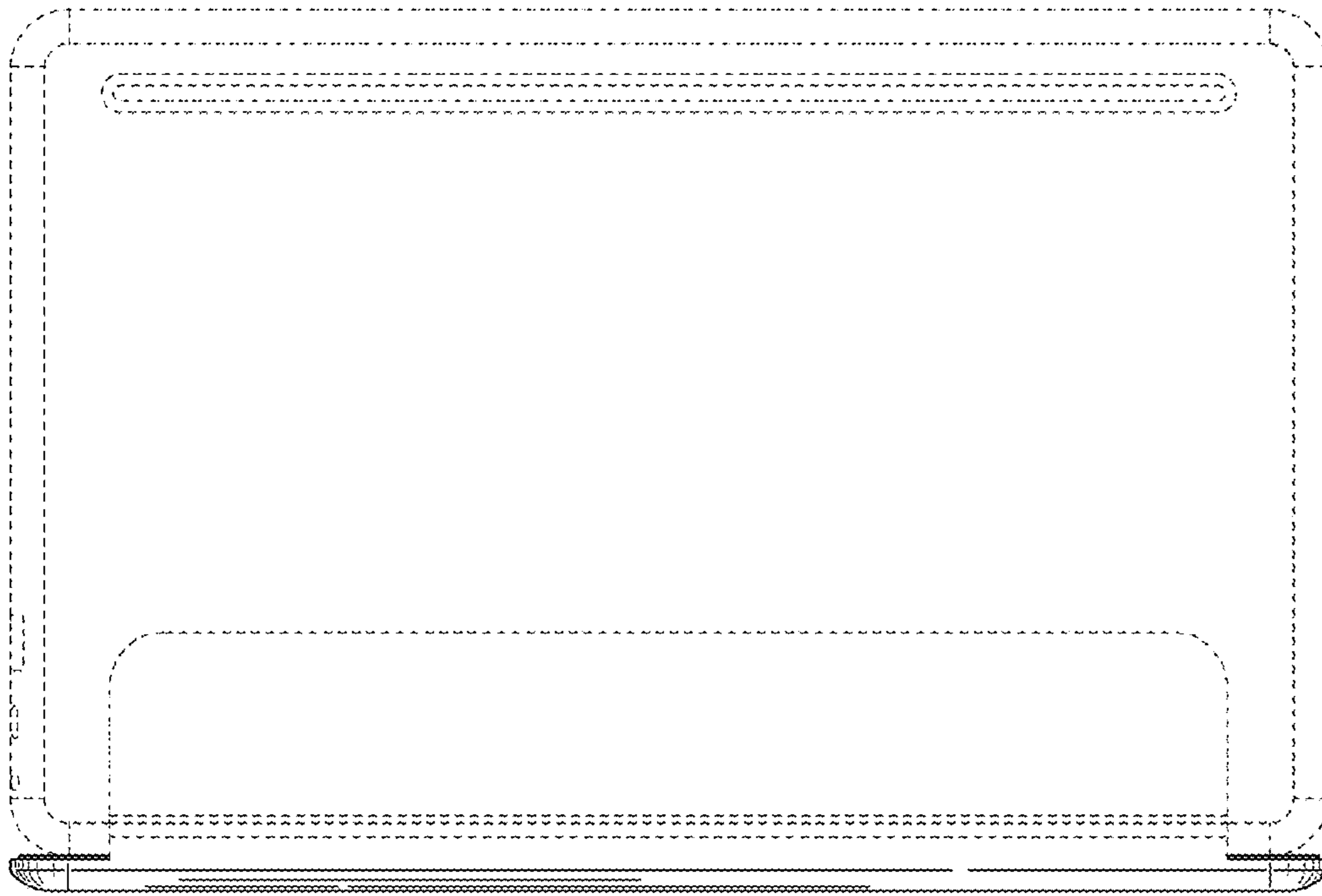

FIG. 8