



US00D750566S

(12) **United States Design Patent**
Katagiyama et al.

(10) **Patent No.:** **US D750,566 S**
(45) **Date of Patent:** **** Mar. 1, 2016**

(54) **OPTICAL CONNECTOR**

(71) Applicant: **Japan Aviation Electronics Industry, Limited**, Tokyo (JP)
(72) Inventors: **Naoki Katagiyama**, Tokyo (JP); **Yuichi Koreeda**, Tokyo (JP)
(73) Assignee: **Japan Aviation Electronics Industry, Limited**, Tokyo (JP)

(**) Term: **15 Years**

(21) Appl. No.: **29/538,753**

(22) Filed: **Sep. 8, 2015**

Related U.S. Application Data

(62) Division of application No. 29/506,918, filed on Oct. 22, 2014, now Pat. No. Des. 740,756.

(30) **Foreign Application Priority Data**

Jun. 23, 2014 (JP) 2014-013565

(51) **LOC (10) Cl.** **13-03**

(52) **U.S. Cl.**
USPC **D13/147**

(58) **Field of Classification Search**
USPC D13/133, 146, 147, 154, 184, 199
See application file for complete search history.

(56) **References Cited**

U.S. PATENT DOCUMENTS

D611,422	S	3/2010	Kato	
D619,536	S	7/2010	Kato	
D640,639	S	6/2011	Gravolin et al.	
D740,756	S *	10/2015	Katagiyama	D13/147
D740,758	S *	10/2015	Katagiyama	D13/147
2006/0245695	A1	11/2006	Fujiwara et al.	
2009/0116793	A1	5/2009	Nishimura et al.	
2009/0257718	A1	10/2009	Nishimura et al.	
2011/0229086	A1	9/2011	Bradley et al.	
2011/0229092	A1	9/2011	Fujiwara et al.	

FOREIGN PATENT DOCUMENTS

JP	1284920	S	10/2006
JP	1408040	S	2/2011

* cited by examiner

Primary Examiner — Daniel Bui

(74) *Attorney, Agent, or Firm* — Cermak Nakajima & McGowan LLP; Tomoko Nakajima

(57) **CLAIM**

The ornamental design for an optical connector, as shown.

DESCRIPTION

FIG. 1 is a front elevational view of an optical connector showing our new design;
FIG. 2 is a top plan view thereof;
FIG. 3 is a right side elevational view thereof;
FIG. 4 is a left side elevational view thereof;
FIG. 5 is a rear elevational view thereof;
FIG. 6 is a bottom plan view thereof;
FIG. 7 is a front perspective view thereof; and,
FIG. 8 is a rear perspective view thereof.

1 Claim, 8 Drawing Sheets

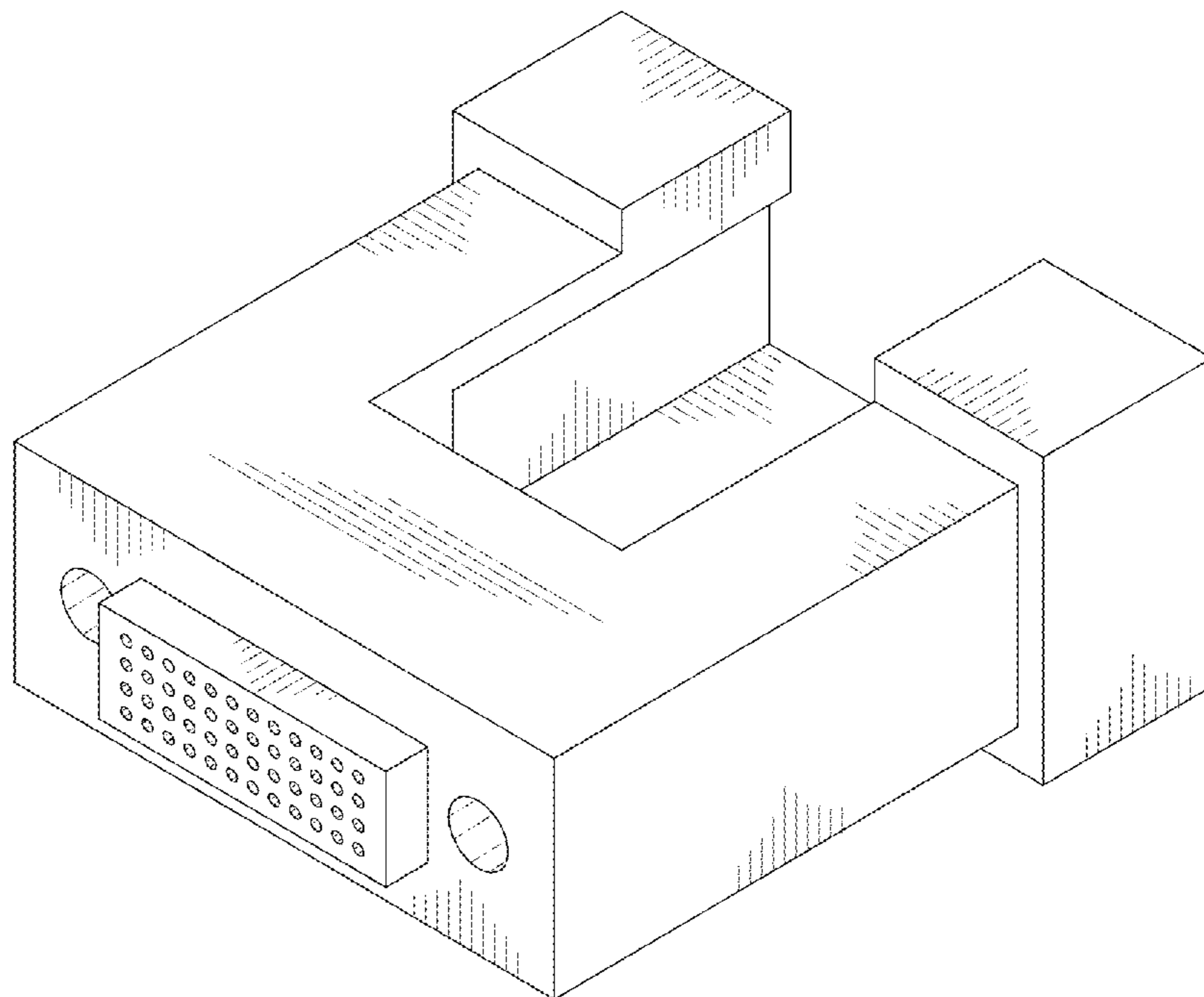

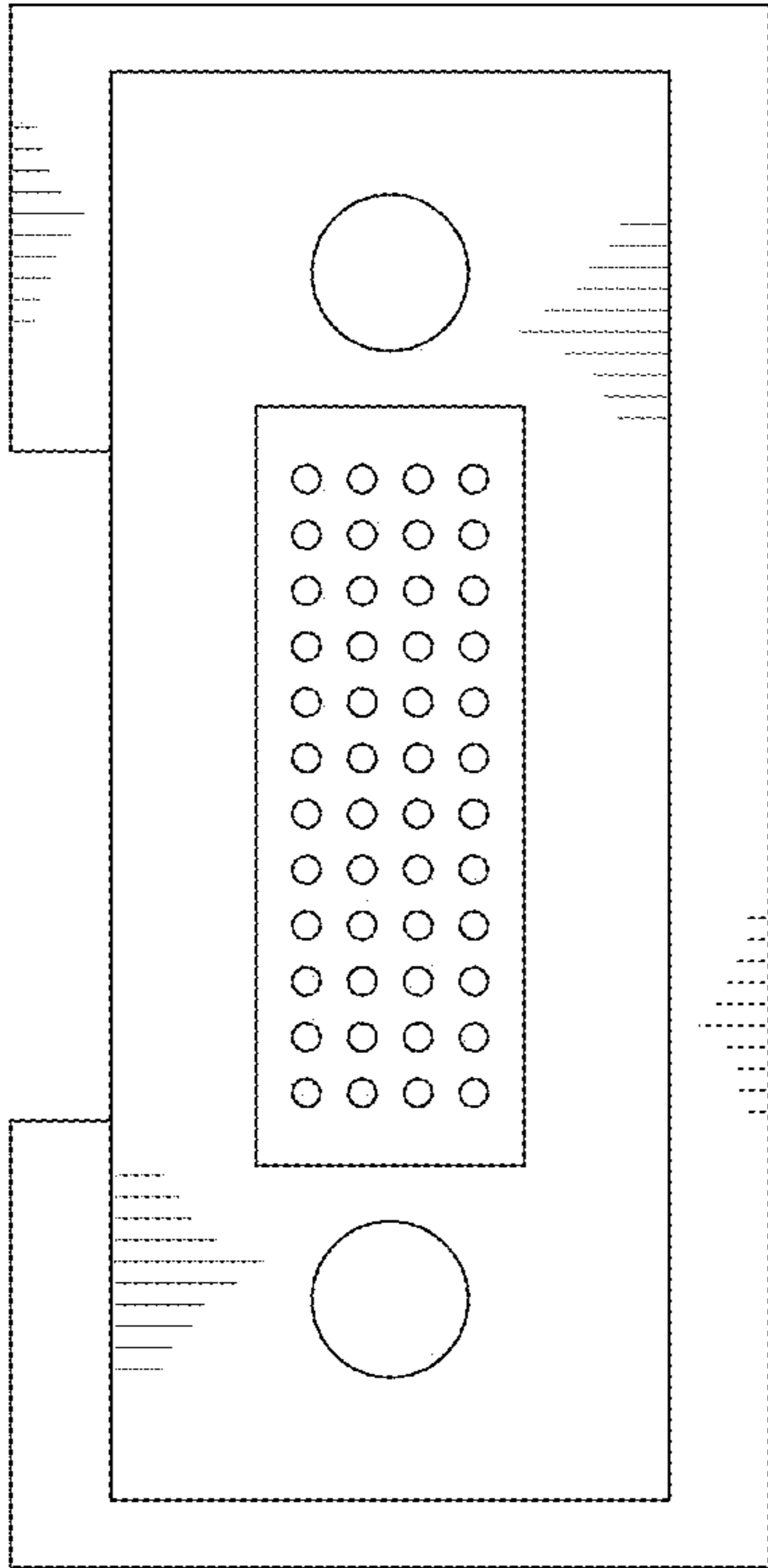

FIG. 1

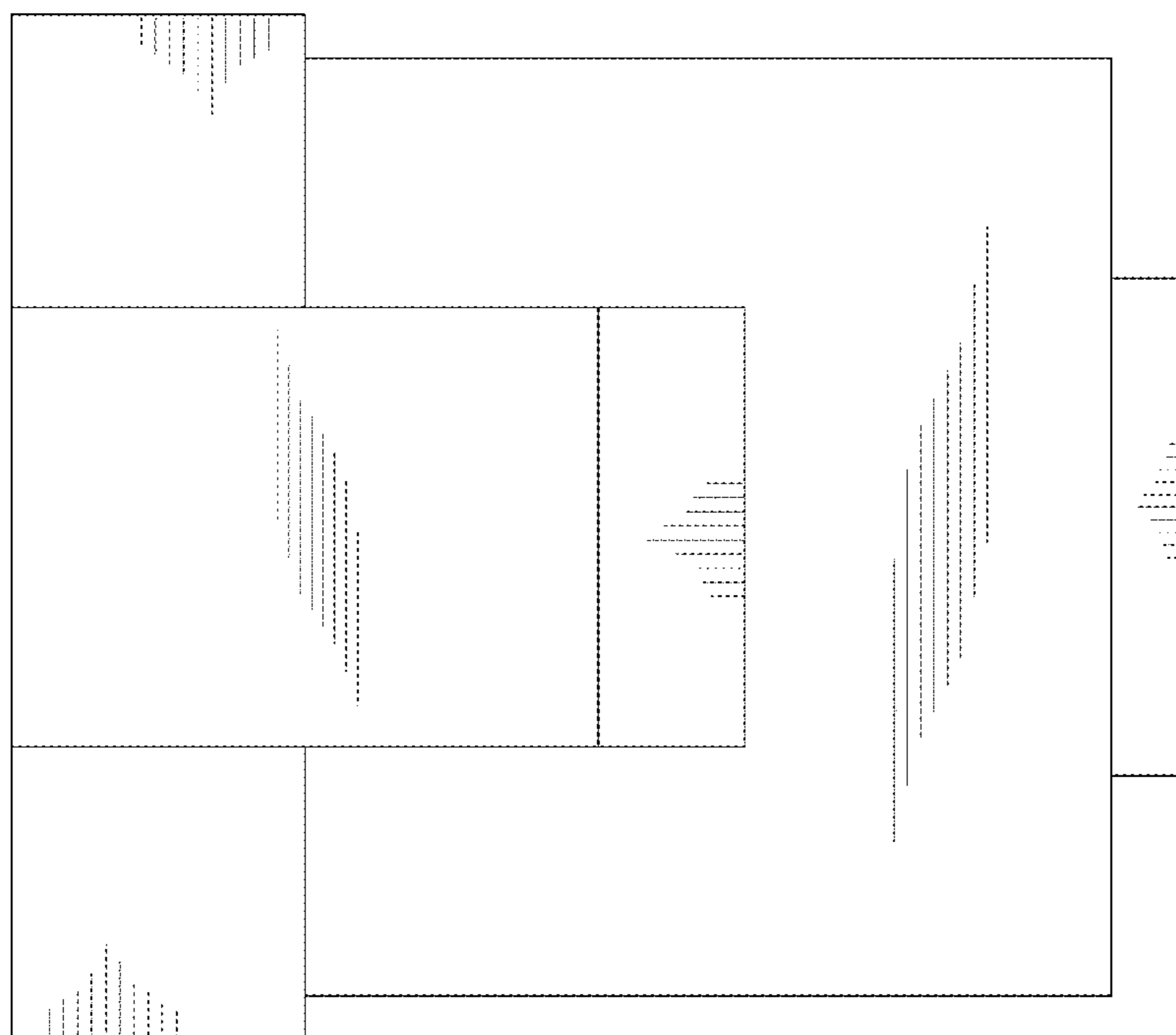

FIG.2

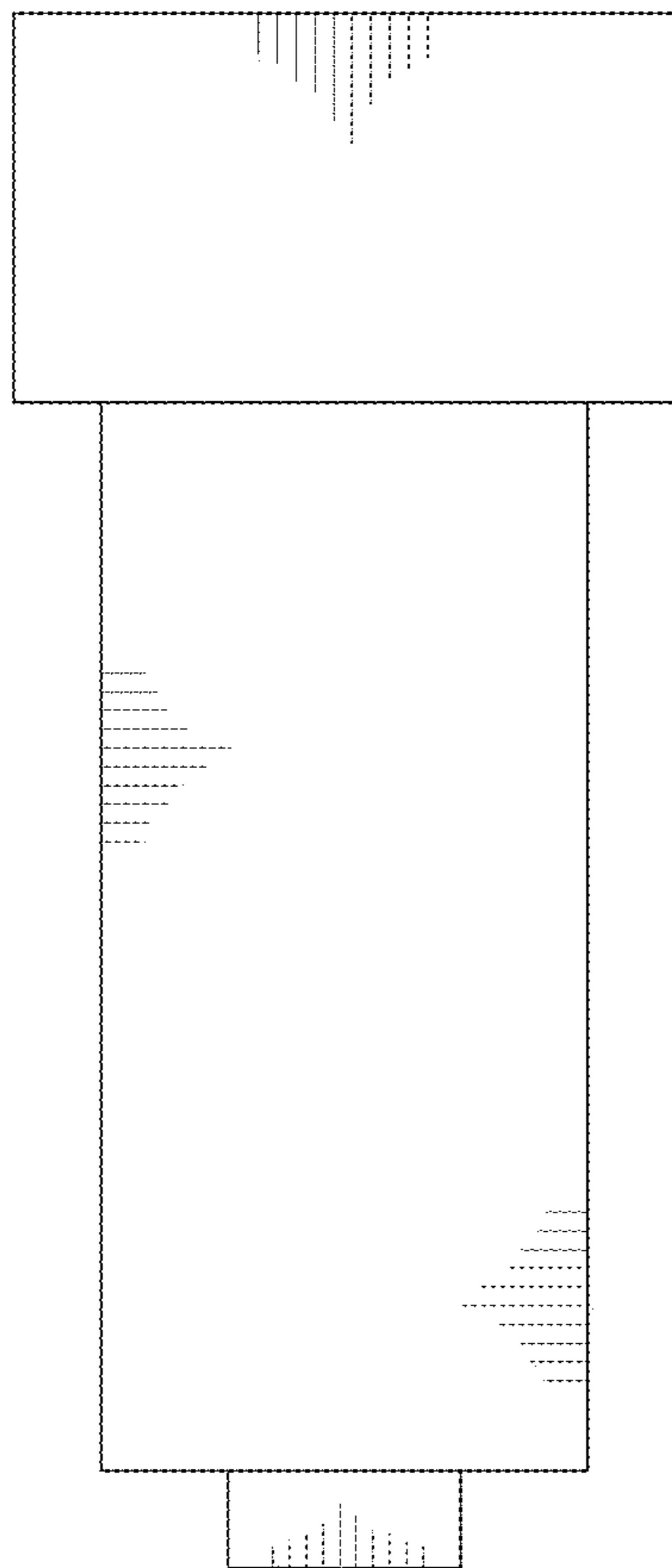

FIG. 3

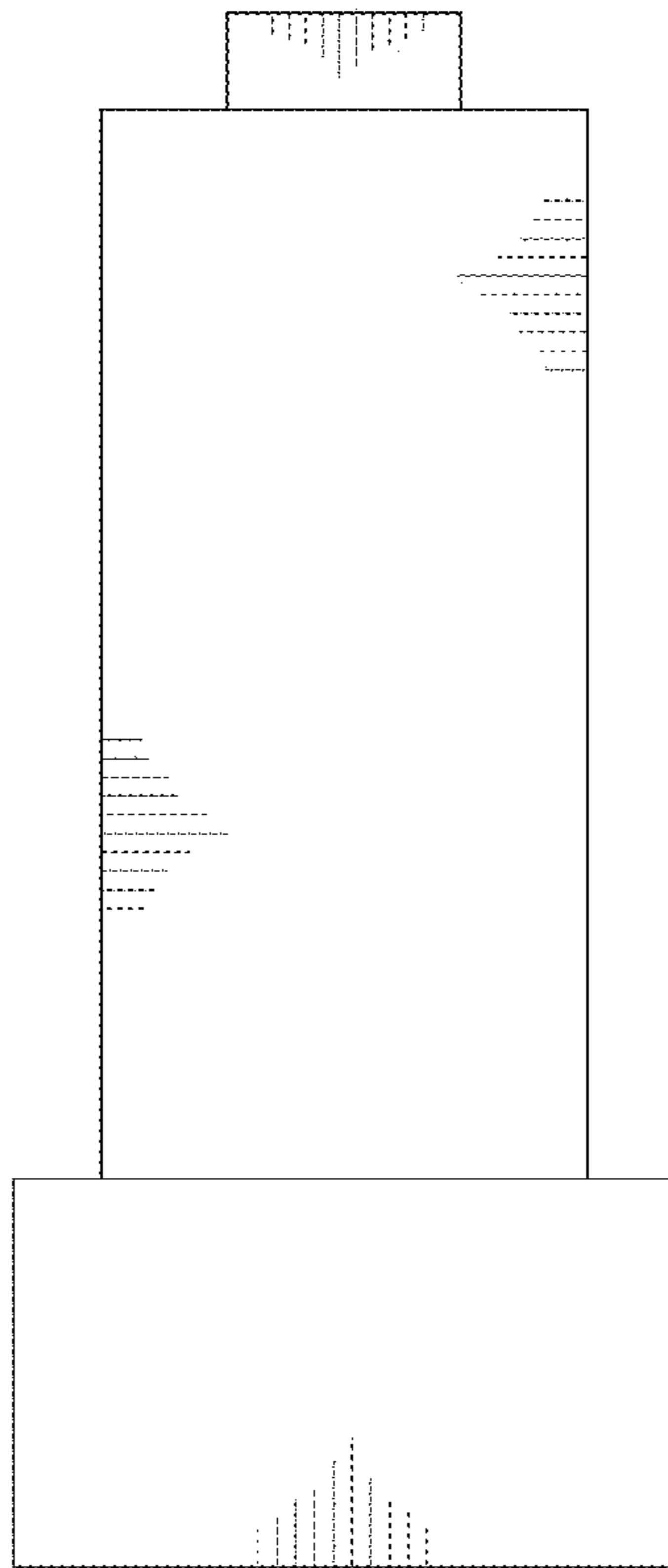

FIG. 4

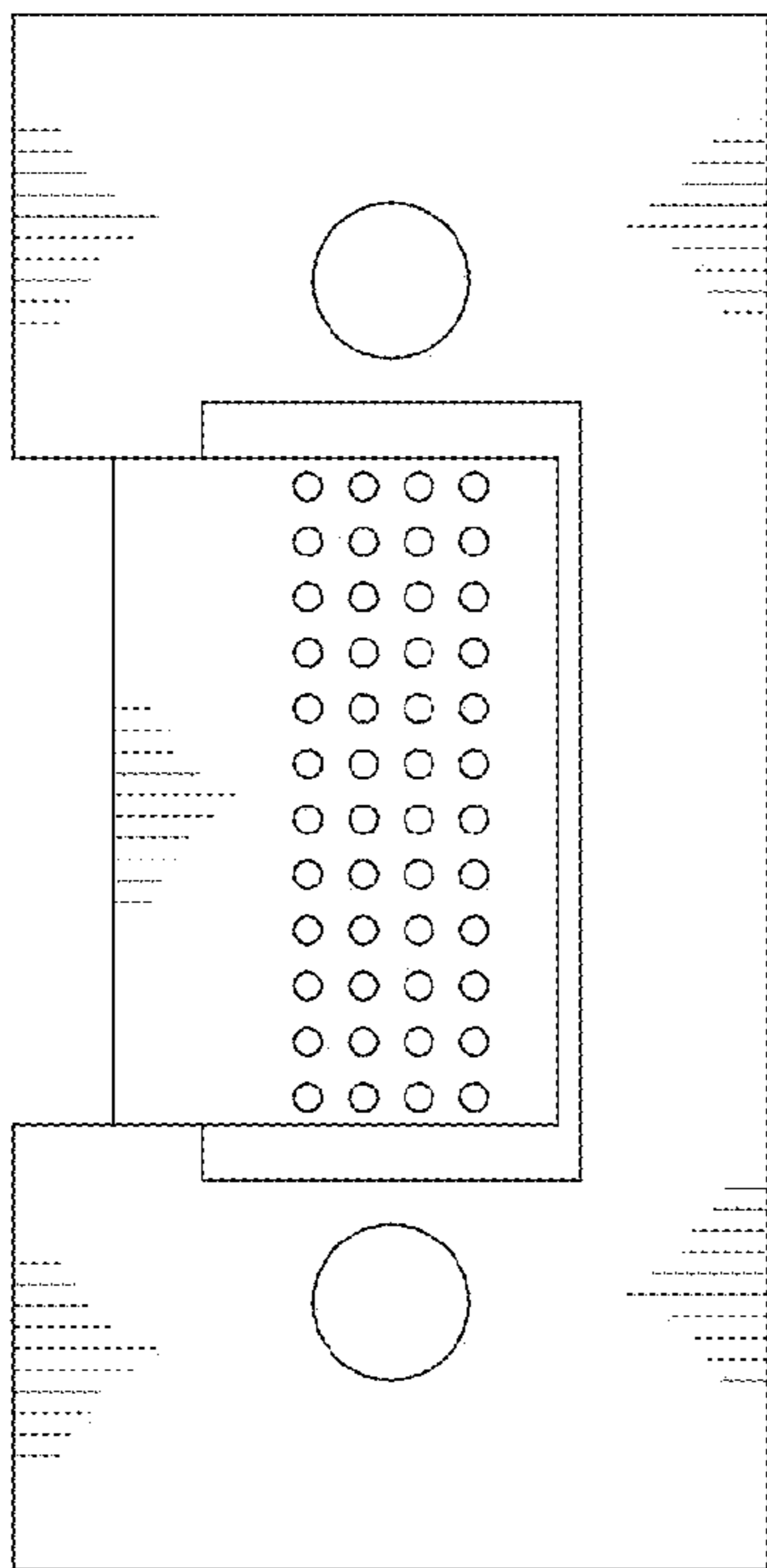

FIG. 5

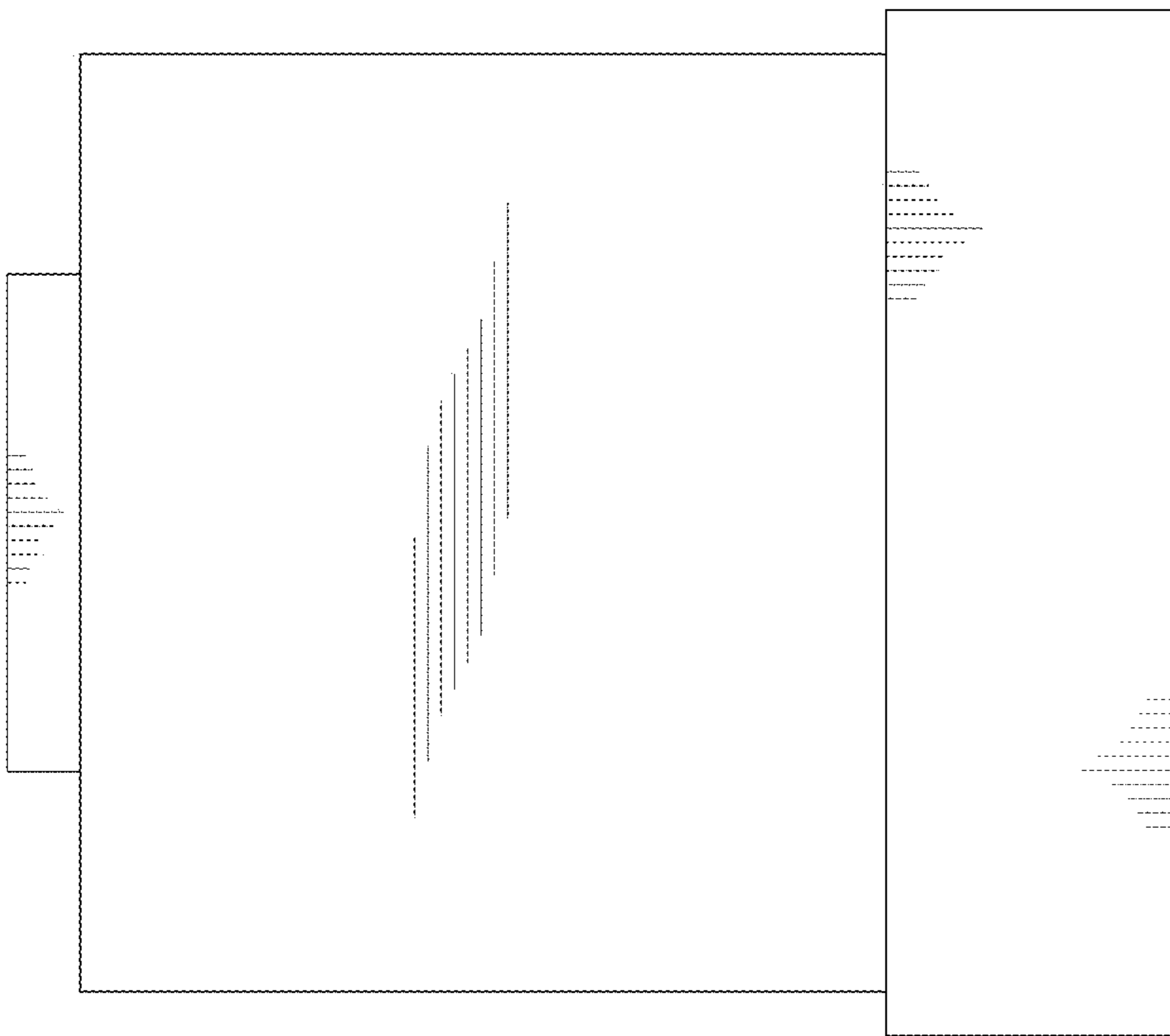

FIG. 6

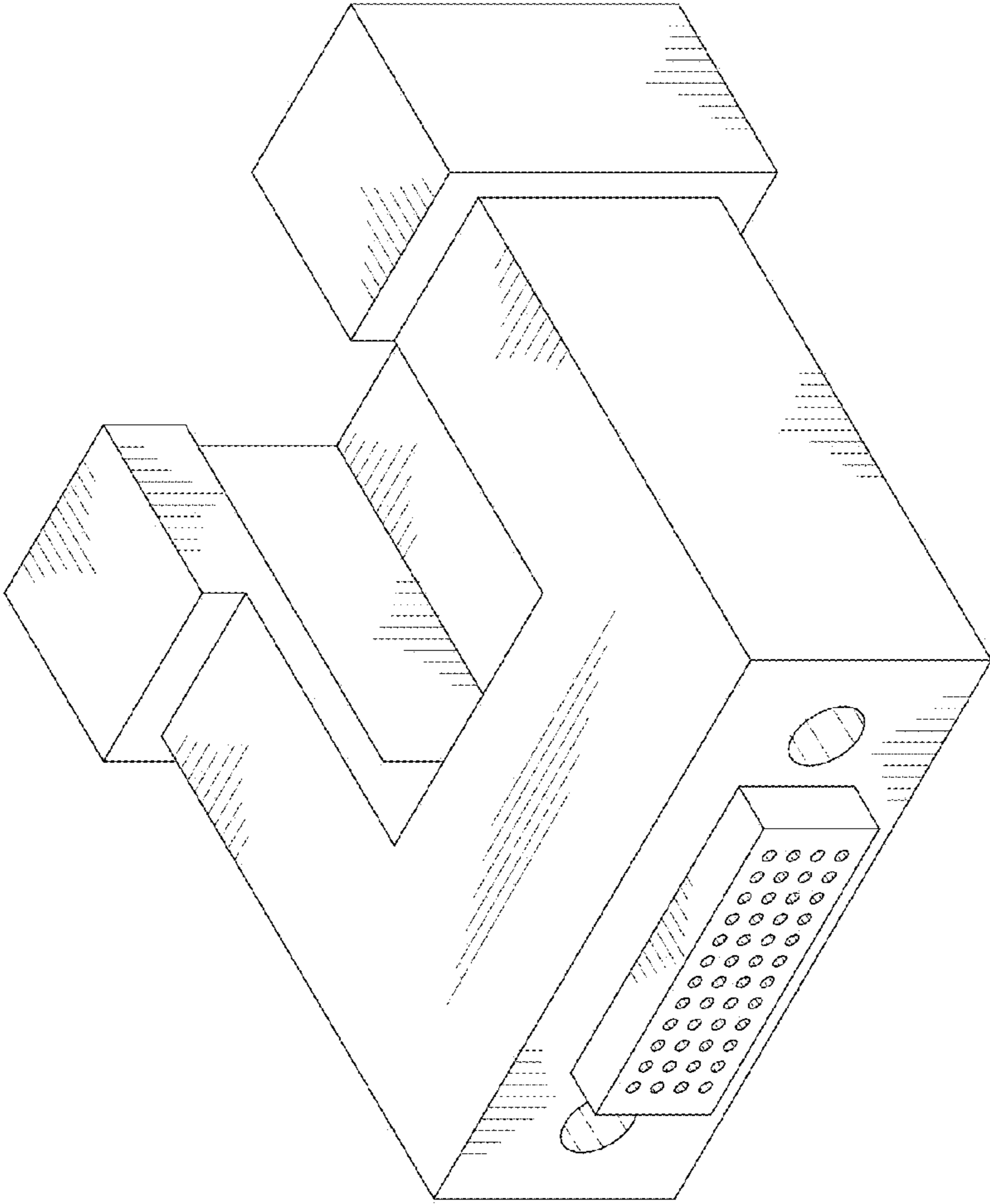

FIG.7

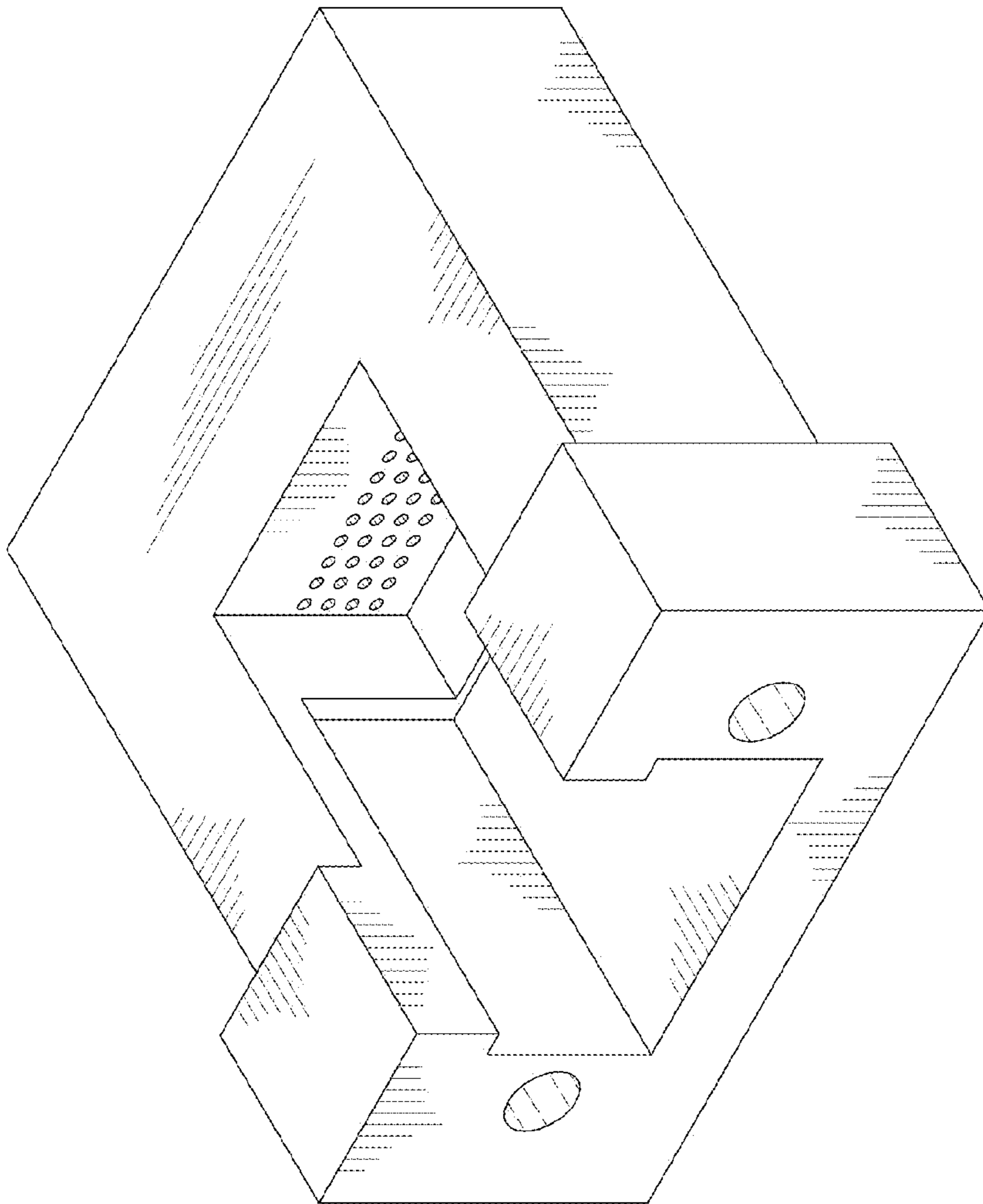

FIG.8