



US00D750485S

(12) **United States Design Patent**  
**Lavoie**

(10) **Patent No.:** **US D750,485 S**  
(45) **Date of Patent:** **\*\* \*Mar. 1, 2016**

(54) **CONTAINER**

(71) Applicant: **MEGA Brands Inc.**, Montreal (CA)

(72) Inventor: **Andréanne Lavoie**, Lorraine (CA)

(73) Assignee: **MEGA Brands Inc.**, Montreal, Quebec (CA)

(\*) Notice: This patent is subject to a terminal disclaimer.

(\*\*) Term: **14 Years**

(21) Appl. No.: **29/493,098**

(22) Filed: **Jun. 5, 2014**

**Related U.S. Application Data**

(63) Continuation of application No. 29/476,263, filed on Dec. 12, 2013, now Pat. No. Des. 707,554.

(51) **LOC (10) Cl.** ..... **09-07**

(52) **U.S. Cl.**  
USPC ..... **D9/435**

(58) **Field of Classification Search**

USPC ..... D9/434, 600, 636, 640, 414, 432, 499;  
D21/484, 500; 446/75, 76, 77, 118;  
D3/270, 271; 273/156, 160; 206/457,  
206/511

CPC . B65D 21/0222; B65D 21/032; B65D 21/036  
See application file for complete search history.

(56) **References Cited**

**U.S. PATENT DOCUMENTS**

D244,632 S 6/1977 Christiansen  
D252,908 S 9/1979 Bayly

(Continued)

**OTHER PUBLICATIONS**

Web page printout, MEGA Brands MEGA Play My Knight's Castle, Aug. 21, 2013, 3 pages, retrieved from <http://web.archive.org/web/20130821180059/http://www.megabloks.com/en-us/shop/construction-toys/mega-play/my-knights-castle>.

(Continued)

*Primary Examiner* — Robert M Spear

(74) *Attorney, Agent, or Firm* — Plumsea Law Group, LLC

(57) **CLAIM**

The ornamental design for a container, as shown and described.

**DESCRIPTION**

FIG. 1 is a top front perspective view of a container showing the new design;

FIG. 2 is a front side elevational view of the container of FIG. 1;

FIG. 3 is a rear side elevational view of the container of FIG. 1;

FIG. 4 is a right side elevational view of the container of FIG. 1;

FIG. 5 is a left side elevational view of the container of FIG. 1;

FIG. 6 is a top plan view of the container of FIG. 1;

FIG. 7 is a bottom plan view of the container of FIG. 1;

FIG. 8 is a top front perspective view of a second embodiment;

FIG. 9 is a front side elevational view of the container of FIG. 8;

FIG. 10 is a rear side elevational view of the container of FIG. 8;

FIG. 11 is a right side elevational view of the container of FIG. 8;

FIG. 12 is a left side elevational view of the container of FIG. 8;

FIG. 13 is a top plan view of the container of FIG. 8;

FIG. 14 is a bottom plan view of the container of FIG. 8;

FIG. 15 is a top front perspective view of a third embodiment;

FIG. 16 is a front side elevational view of the container of FIG. 15;

FIG. 17 is a rear side elevational view of the container of FIG. 15;

FIG. 18 is a right side elevational view of the container of FIG. 15;

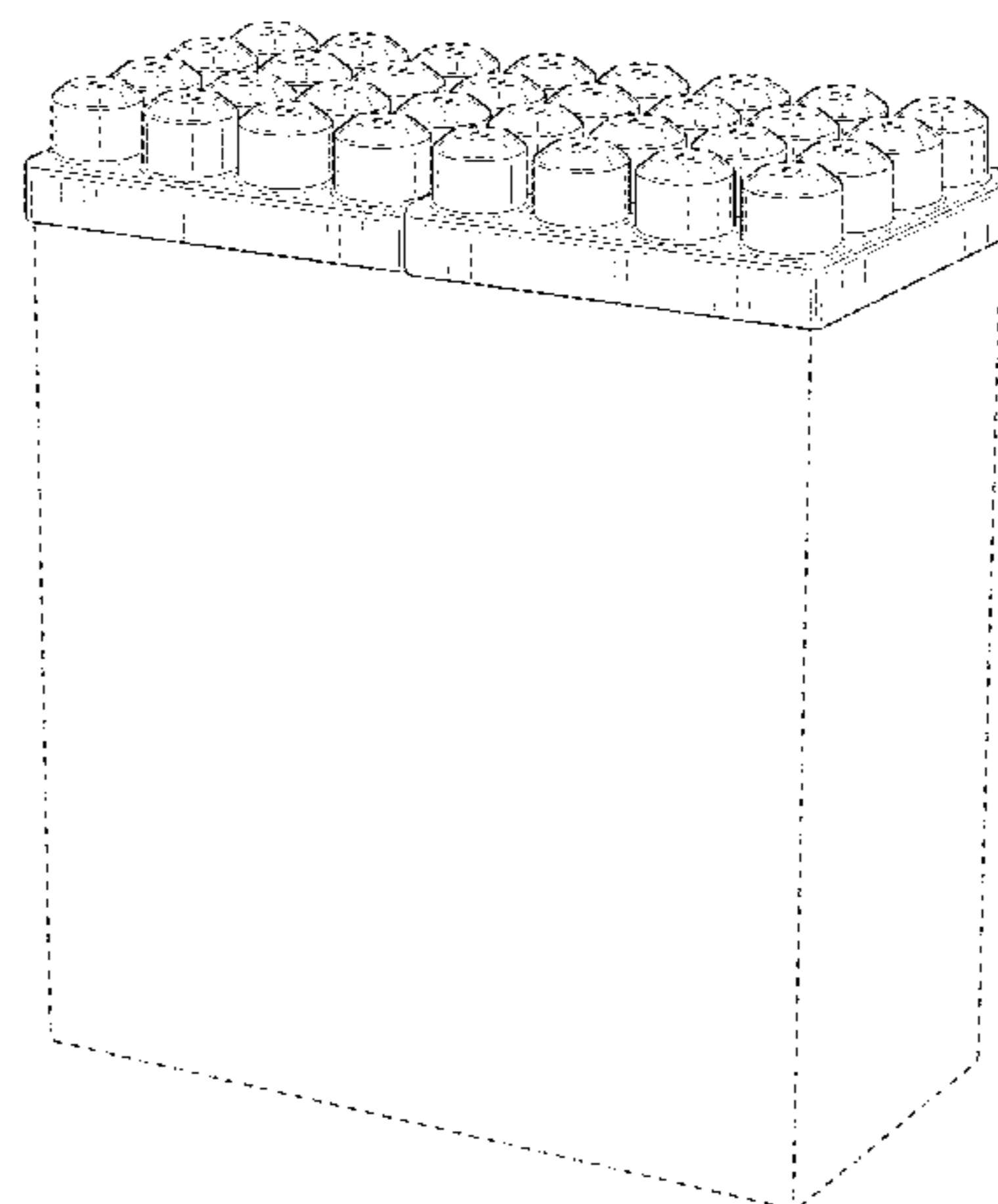
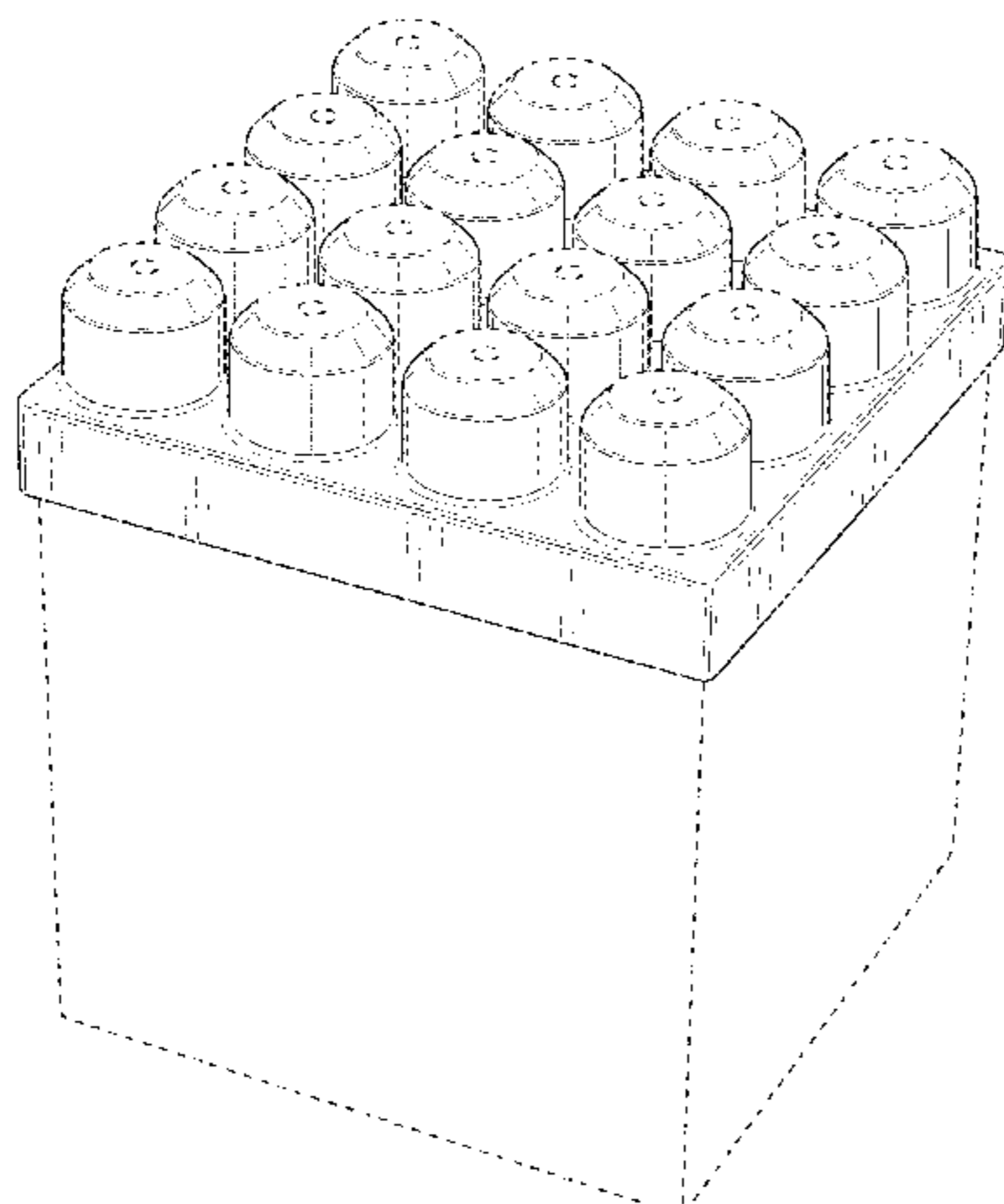
FIG. 19 is a left side elevational view of the container of FIG. 15;

FIG. 20 is a top plan view of the container of FIG. 15; and,

FIG. 21 is a bottom plan view of the container of FIG. 15.

The broken lines in the drawings immediately adjacent shaded surfaces represent boundaries of the claims; all other broken lines represent unclaimed environmental subject matter. The broken lines form no part of the claim.

**1 Claim, 21 Drawing Sheets**



(56)

References Cited

U.S. PATENT DOCUMENTS

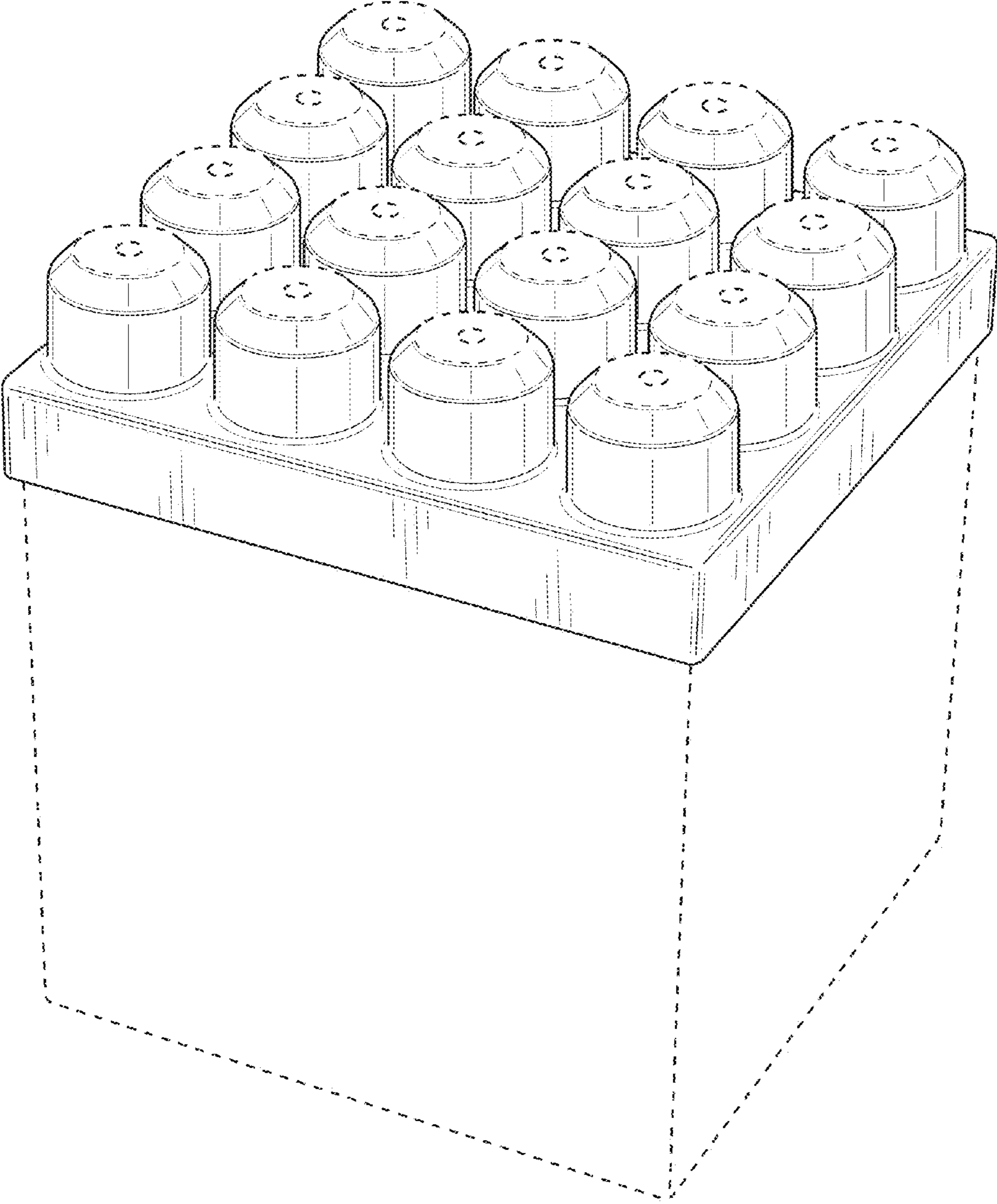
D252,909 S 9/1979 Bayly  
 D252,910 S 9/1979 Bayly  
 D252,977 S 9/1979 Bayly  
 D252,978 S 9/1979 Bayly  
 D252,979 S 9/1979 Bayly  
 D252,980 S 9/1979 Bayly  
 D252,981 S 9/1979 Fenton  
 D286,417 S 10/1986 Takahashi  
 D294,373 S 2/1988 Bertrand  
 D295,093 S 4/1988 Tapdrup  
 D295,094 S 4/1988 Tapdrup  
 D296,023 S 5/1988 Tapdrup  
 4,809,980 A 3/1989 Bertrand  
 4,822,314 A 4/1989 O'Brian et al.  
 D301,260 S 5/1989 McLaughlin et al.  
 D308,705 S 6/1990 Olsen  
 D309,332 S 7/1990 Olsen  
 D321,648 S 11/1991 Ricci  
 D324,964 S 3/1992 Ryaa  
 D325,477 S 4/1992 Poulsen et al.  
 D327,185 S 6/1992 Ryaa  
 D328,201 S 7/1992 Ryaa  
 5,188,221 A 2/1993 Bertrand  
 D342,555 S 12/1993 Berggreen  
 D343,355 S 1/1994 Bertrand  
 D350,787 S 9/1994 Hojlund et al.  
 D351,005 S 9/1994 Hojlund et al.  
 D355,763 S 2/1995 Sun  
 D357,410 S 4/1995 Rask et al.  
 D359,523 S 6/1995 Yeung  
 D360,908 S 8/1995 Ruskai  
 D363,515 S 10/1995 Mathiesen  
 D364,656 S 11/1995 Ruskai  
 D365,756 S 1/1996 Rask et al.  
 D370,035 S 5/1996 Olsen  
 D373,151 S 8/1996 Mathiesen  
 D378,838 S 4/1997 Olsen et al.  
 5,674,103 A 10/1997 Bean  
 5,676,251 A 10/1997 Credle, Jr.  
 D389,408 S 1/1998 Rask et al.  
 5,709,304 A 1/1998 Credle, Jr.  
 D394,680 S 5/1998 Andersen  
 5,779,515 A 7/1998 Chung  
 5,876,776 A 3/1999 Credle, Jr.  
 D408,142 S 4/1999 Song  
 5,890,595 A 4/1999 Credle, Jr.  
 D426,933 S 6/2000 Redfern  
 D442,779 S 5/2001 Koefeld et al.  
 6,443,796 B1 9/2002 Shackelford  
 D487,544 S 3/2004 Jessen et al.  
 7,252,196 B1 8/2007 Koefeld et al.  
 7,416,166 B1 8/2008 Shaw  
 7,448,380 B2 11/2008 Bright

7,537,119 B2 5/2009 Becklin  
 7,740,138 B2 6/2010 Becklin  
 8,002,241 B1 8/2011 Shaw  
 D652,952 S 1/2012 Angel  
 D694,703 S 12/2013 Faro  
 D695,626 S 12/2013 Webster et al.  
 D707,554 S \* 6/2014 Lavoie ..... D9/435

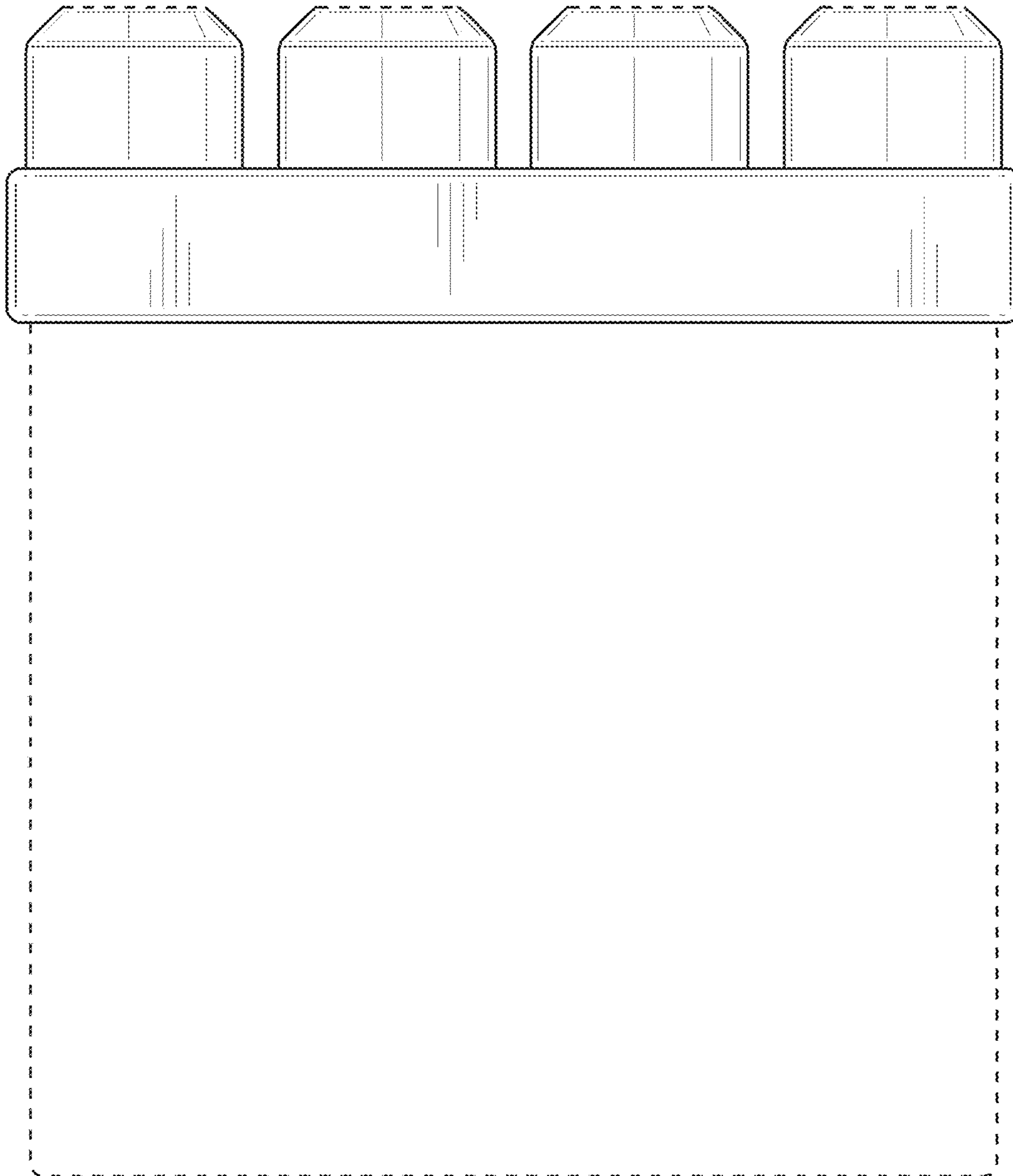
OTHER PUBLICATIONS

Web page printout from Brick Link (<http://www.bricklink.com/>), Fun with Bricks, Part 4628-1, 2012, 2 pages.  
 Web page printout from Brick Link (<http://www.bricklink.com/>), LEGO Duplo XXL Box, Part 5511-1, 2010, 2 pages.  
 Web page printout from Brick Link (<http://www.bricklink.com/>), LEGO XXL Box, Part 5512-1, 2010, 2 pages.  
 Web page printout from Brick Link (<http://www.bricklink.com/>), LEGO Building Fun, Part 5549-1, 2010, 2 pages.  
 MEGA Play Giant Adventure Castle Instruction Manual, 2003, 7 pages.  
 MEGA Play My Own Home Instruction Manual, 2003, 11 pages.  
 Excerpt of 1997 Mega Bloks Catalog, 3 pages.  
 Excerpt of 1998 Mega Bloks Catalog, 2 pages.  
 Excerpt of 2000 Mega Bloks Catalog, 2 pages.  
 Excerpt of 2002 Mega Bloks Catalog, 2 pages.  
 Excerpt of 2003 Mega Bloks Catalog, 3 pages.  
 Excerpt of 2004 Mega Bloks Catalog, 3 pages.  
 Excerpt of 2006 Mega Bloks Catalog, 2 pages.  
 Excerpt of 2007 Mega Bloks Catalog, 2 pages.  
 Excerpt of 2011 Mega Bloks Catalog, 3 pages.  
 Excerpt of 2012 Mega Bloks Catalog, 4 pages.  
 Excerpt of 2013 Mega Bloks Catalog, 3 pages.  
 Web page printout from LEGO (<http://www.brickset.com/detail/?set=5931-1>), 5931-1 My First LEGO DUPLO Set, 4 pages, Jan. 24, 2014.  
 Web page printout from LEGO (<http://guide.lugnet.com/set/5931>), 5931 My First LEGO DUPLO Set, 1 page, Jan. 24, 2014.  
 Office Action mailed Apr. 4, 2014 in U.S. Appl. No. 29/481,711.  
 X-Large LEGO Storage Brick, earliest date Dec. 17, 2011, 4 pages. Found online at <http://www.containerStore.com/shop/toyStorage/boxescases?productid=10031697>.  
 "Contain This! The Container Store Opens in Las Vegas", Toni Spilsbury.com; p. 8 of 19; dated May 22, 2012. Found online at <http://tonispilsbury.com/contain/>.  
 Mega Bloks First Builder Recue Center ad, Target.com, earliest date Dec. 22, 2012, 3 pages. Found online at <http://www.target.com/p/mega-bloks-first-builders-recue-center/-/A-14079461?ref=tgt-adv> . . . .  
 LEGO DUPLO—My First Garden. Mighty Ape Co. website, see p. 4 of 8; release date 1/131/12013. Found online at <http://www.mightyape.co.nz/product/LEGO-DUPLO-My-First-Garden-10517121010259>.

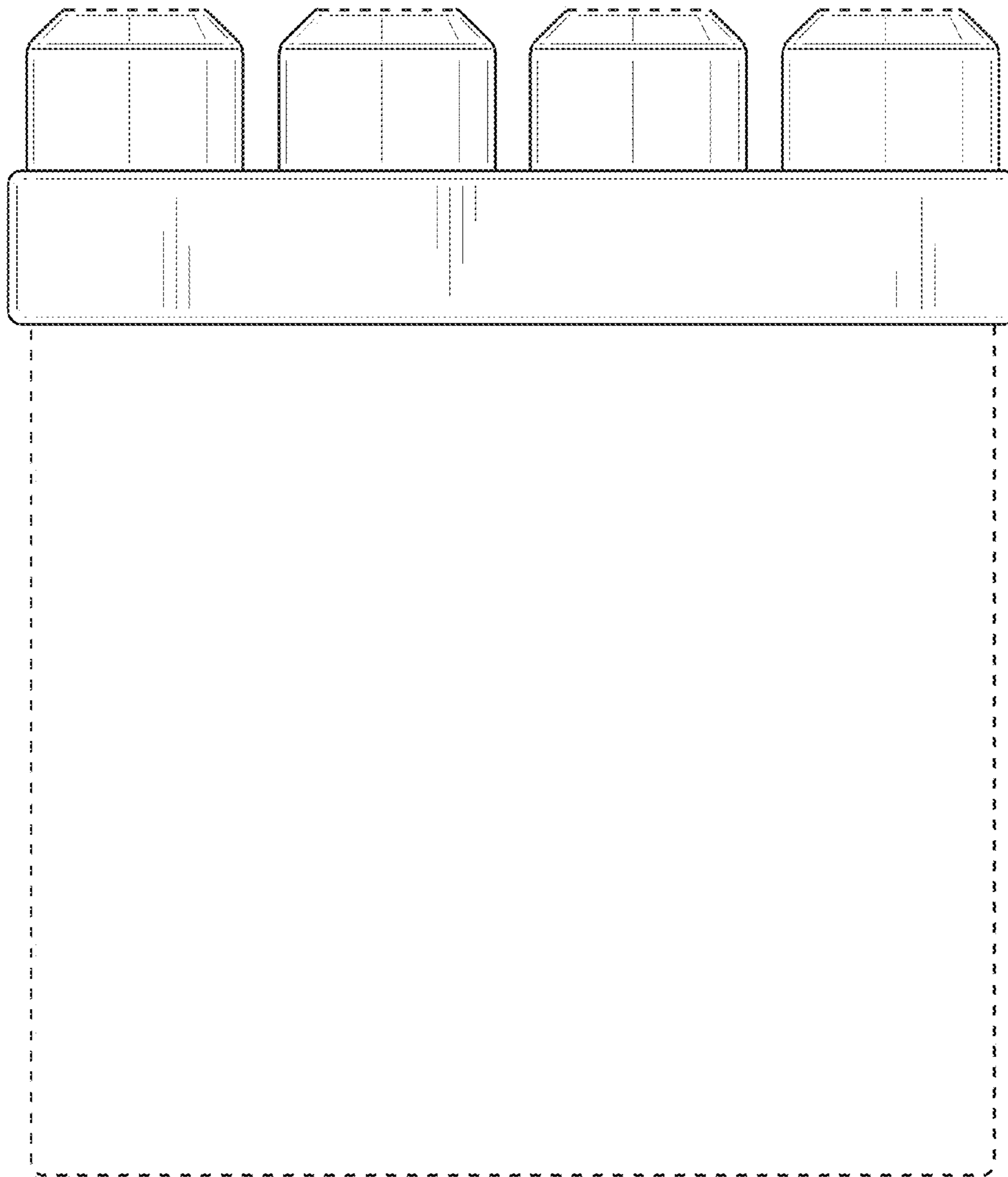
\* cited by examiner



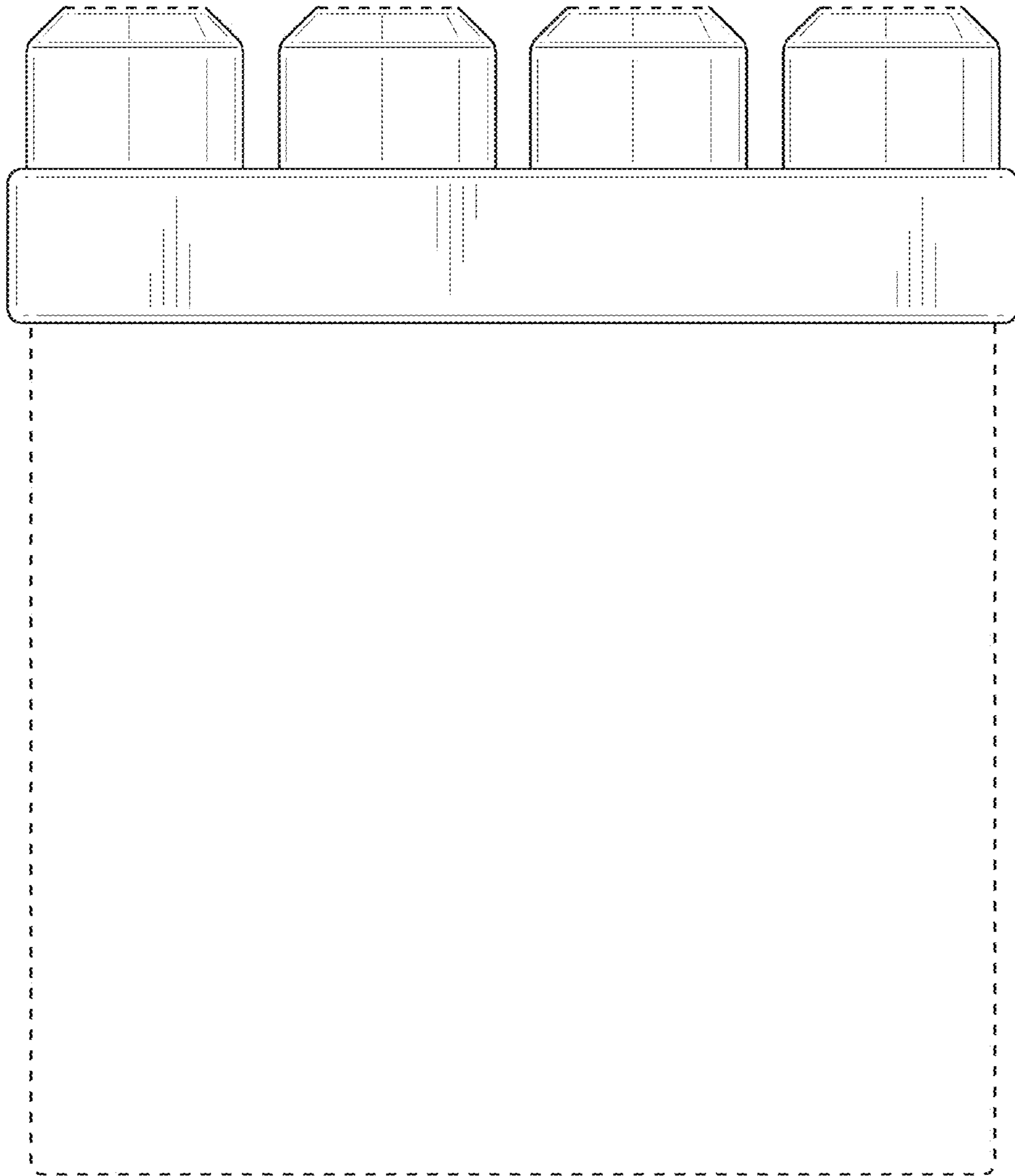
**FIG. 1**



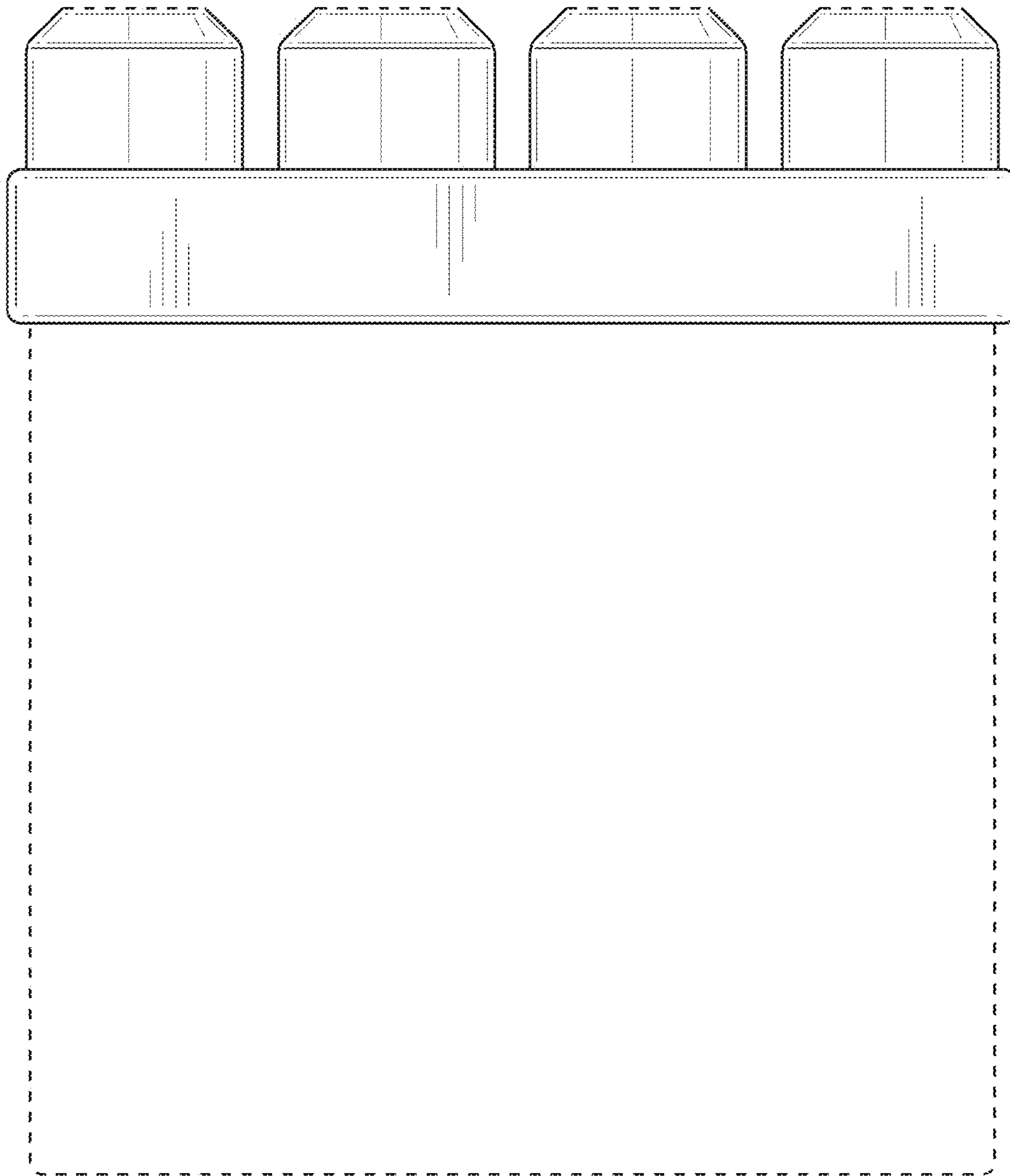
**FIG. 2**



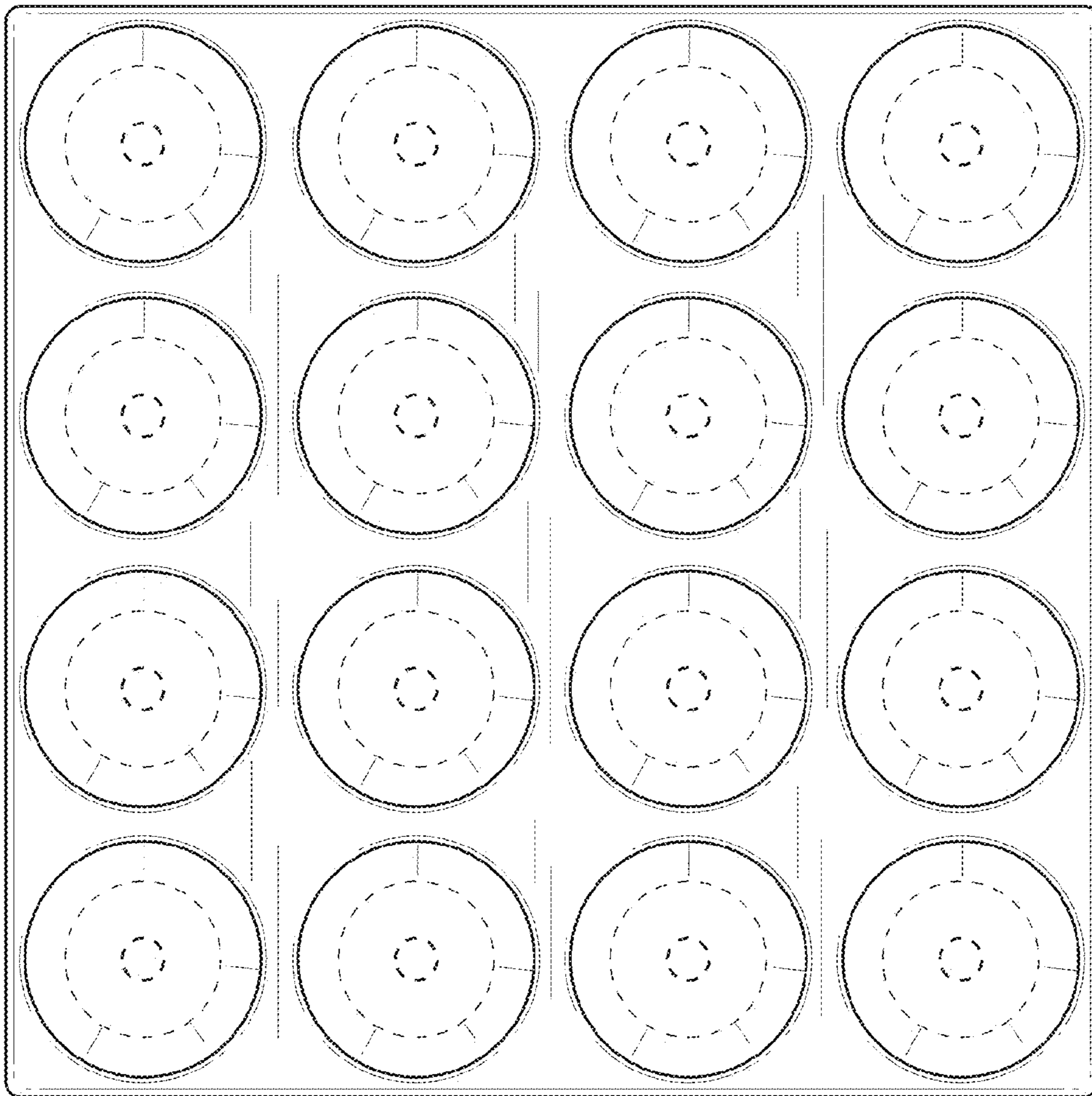
**FIG. 3**



**FIG. 4**



**FIG. 5**

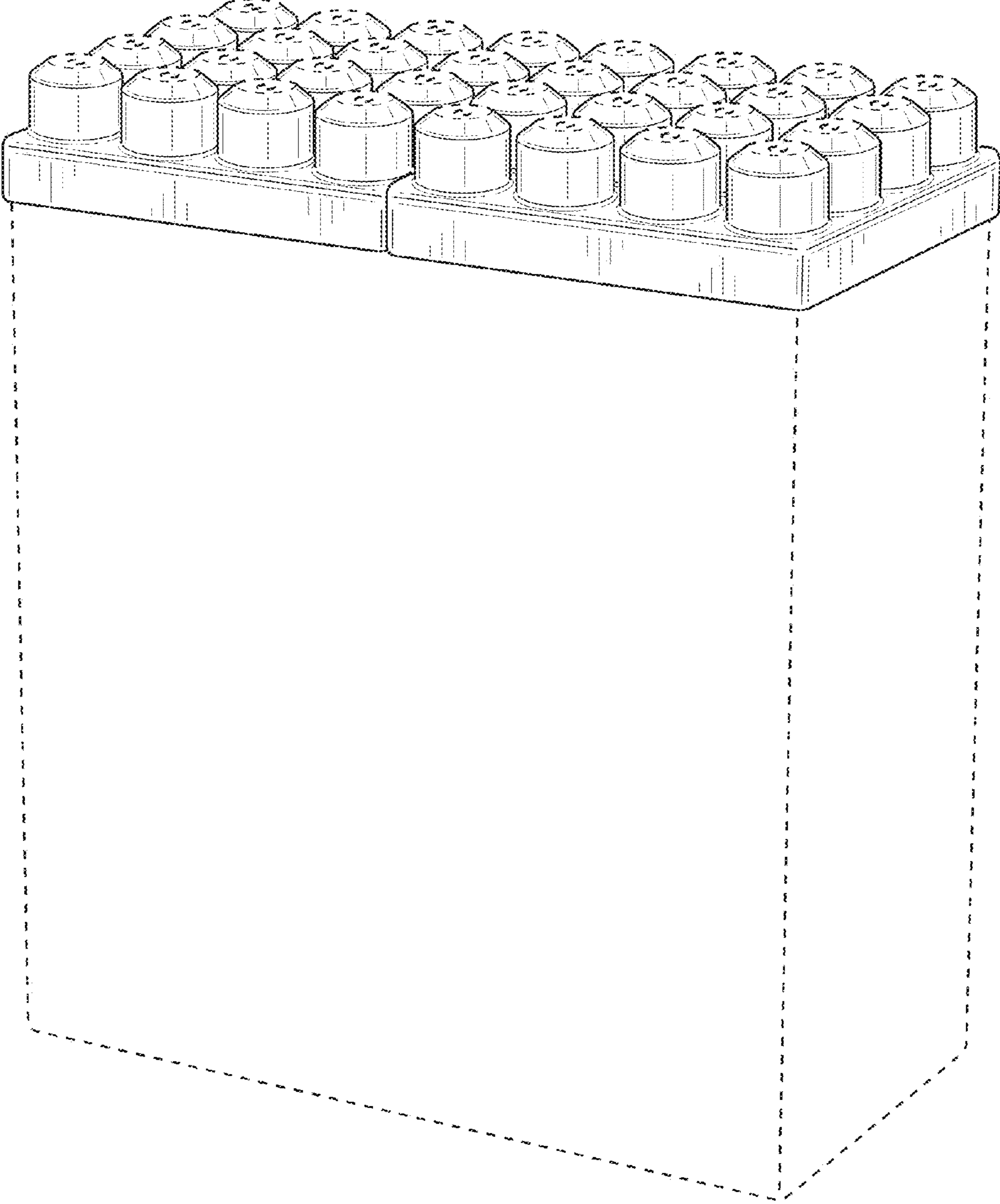


**FIG. 6**

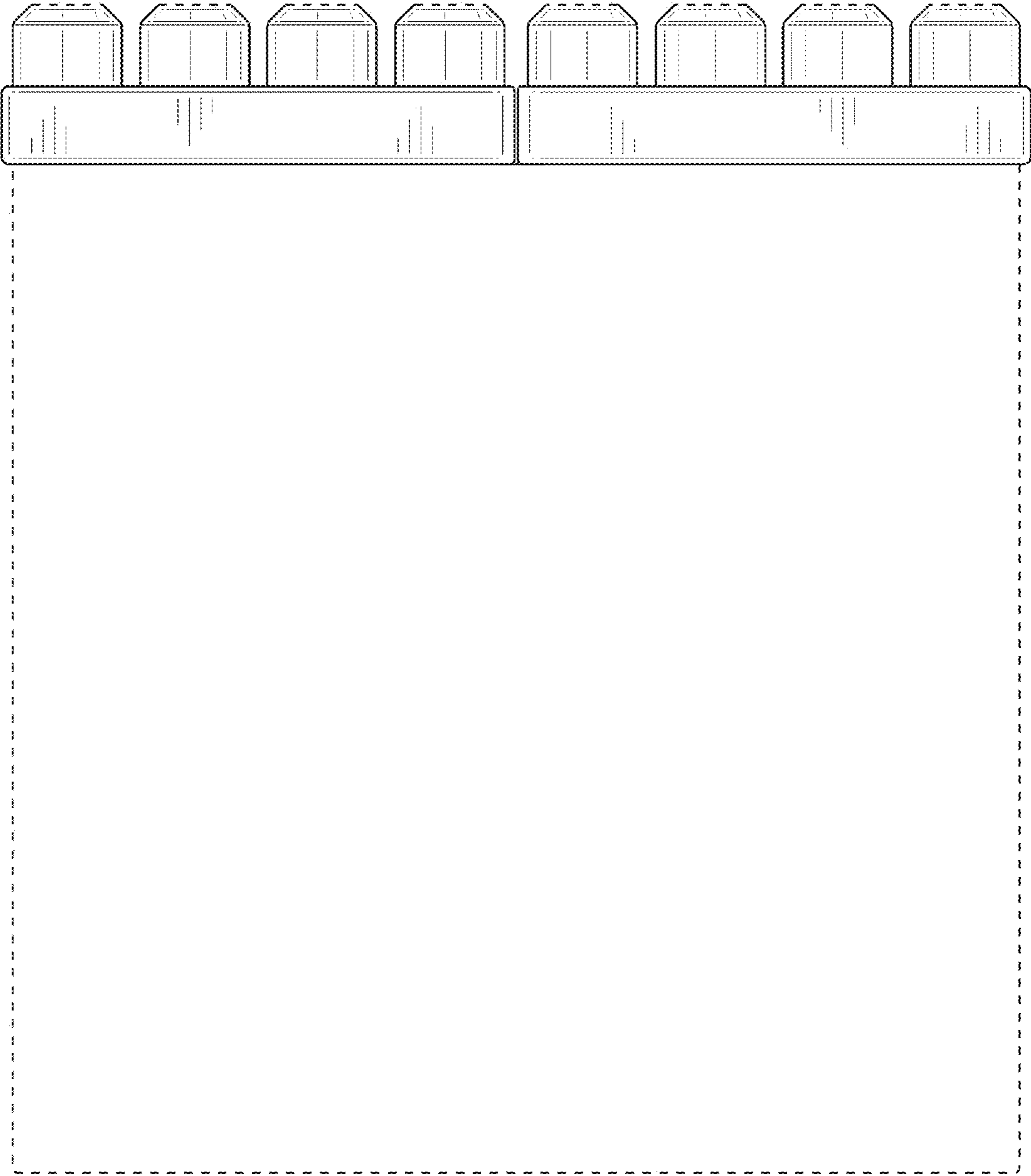




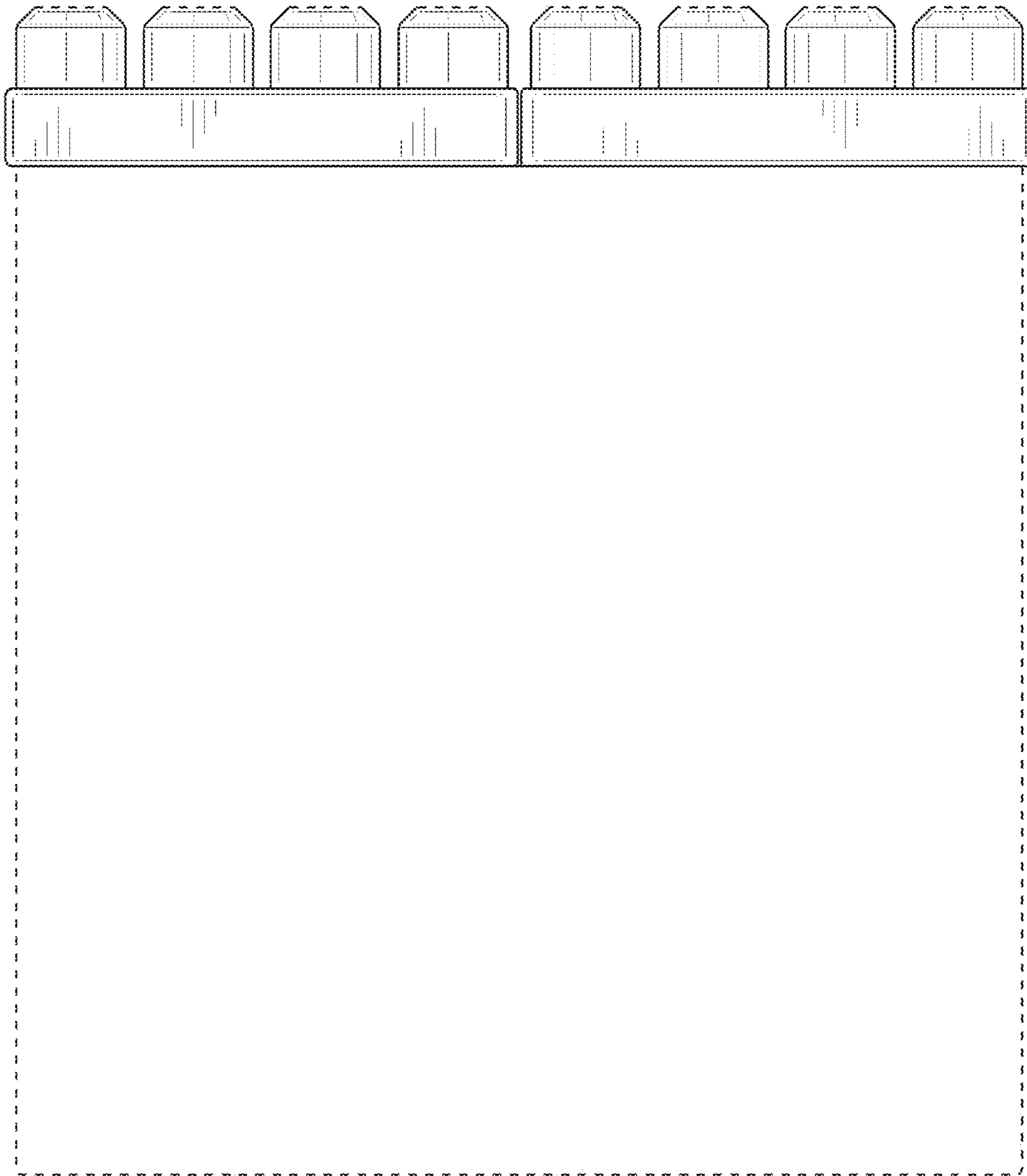
**FIG. 7**



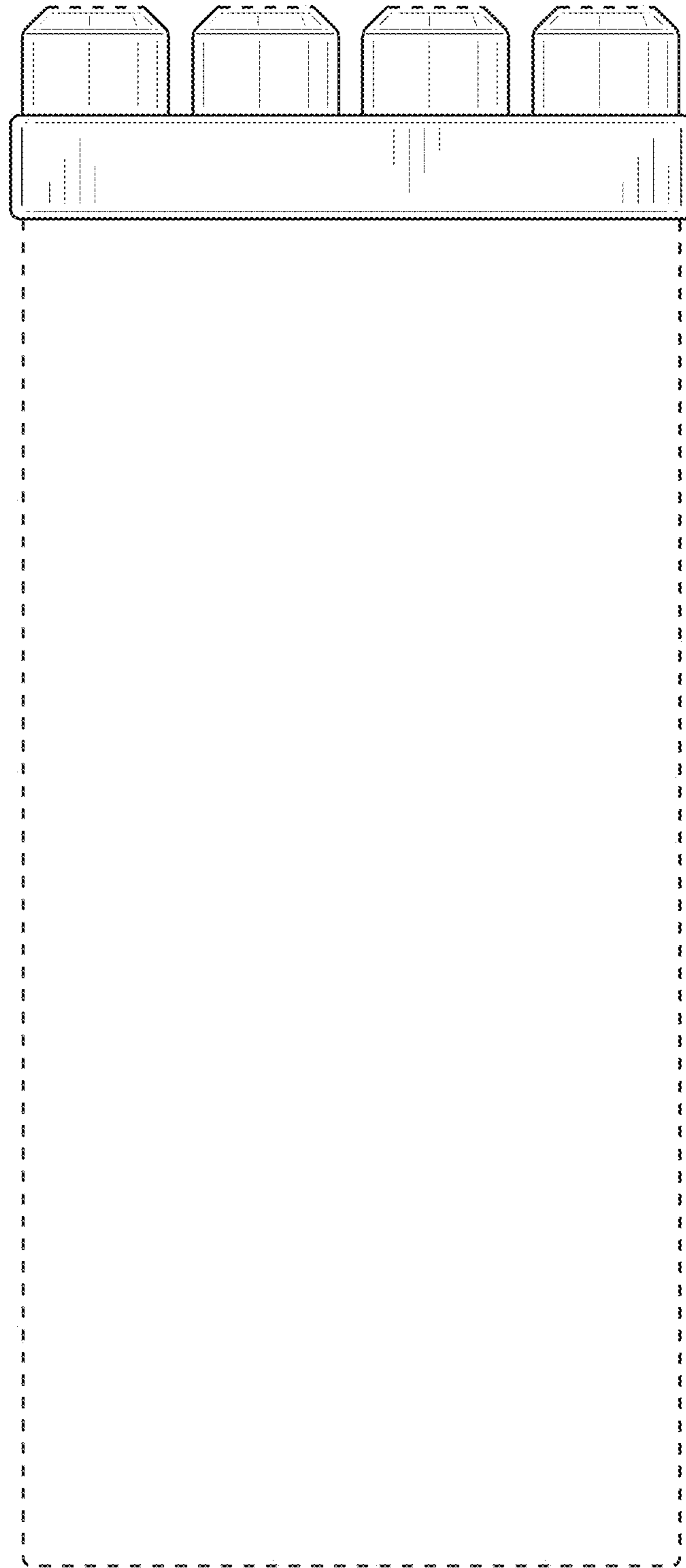
**FIG. 8**



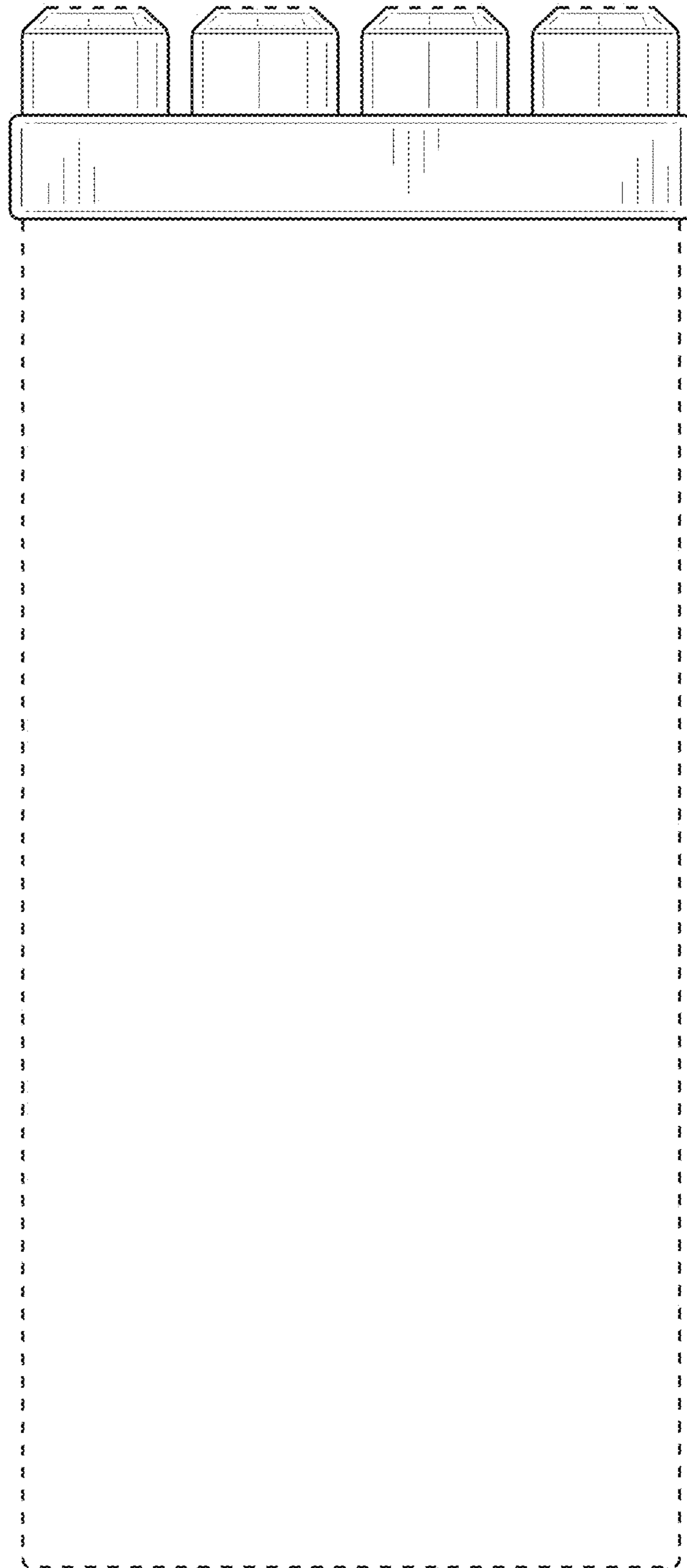
**FIG. 9**



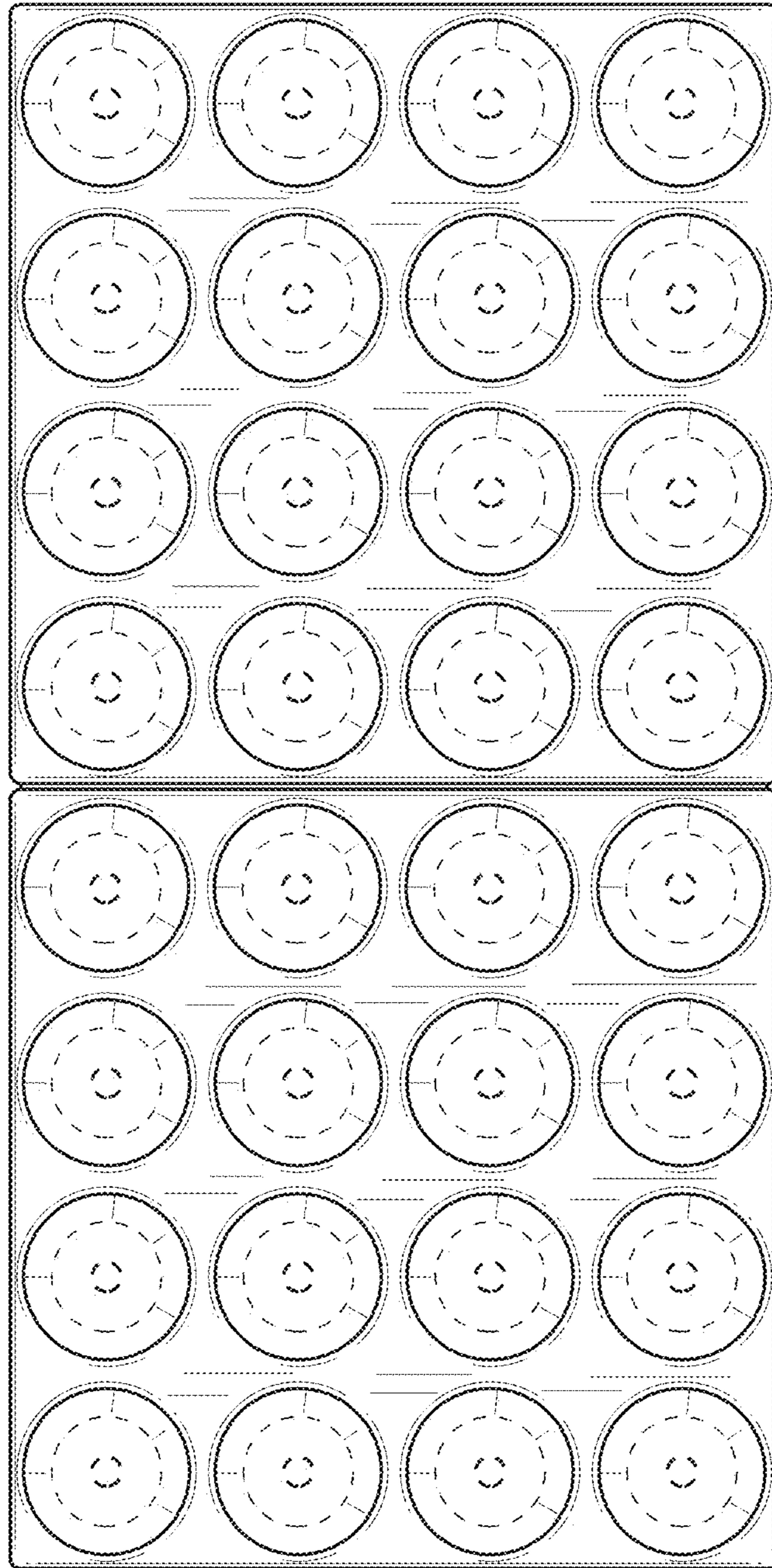
**FIG. 10**



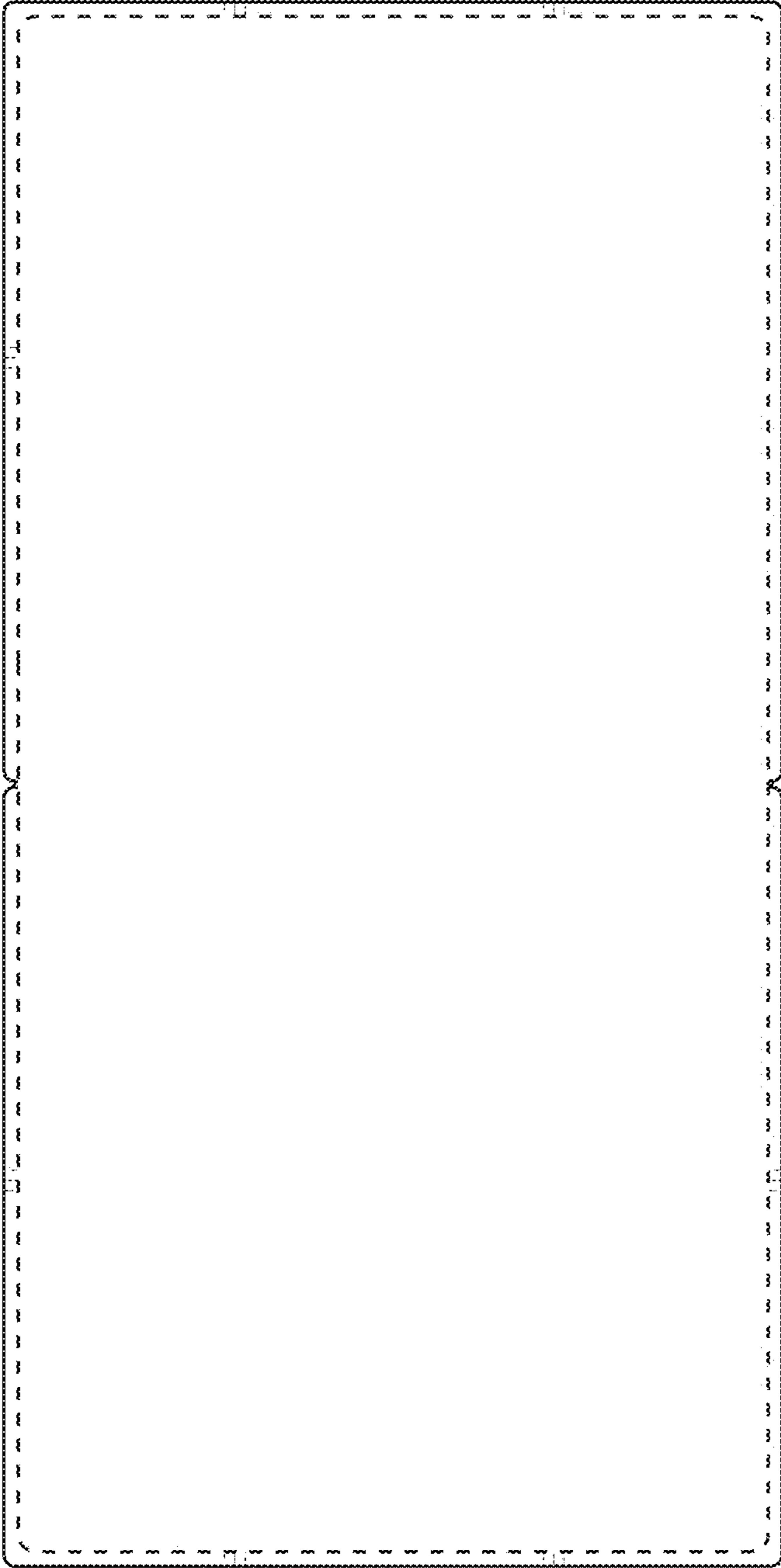
**FIG. 11**



**FIG. 12**

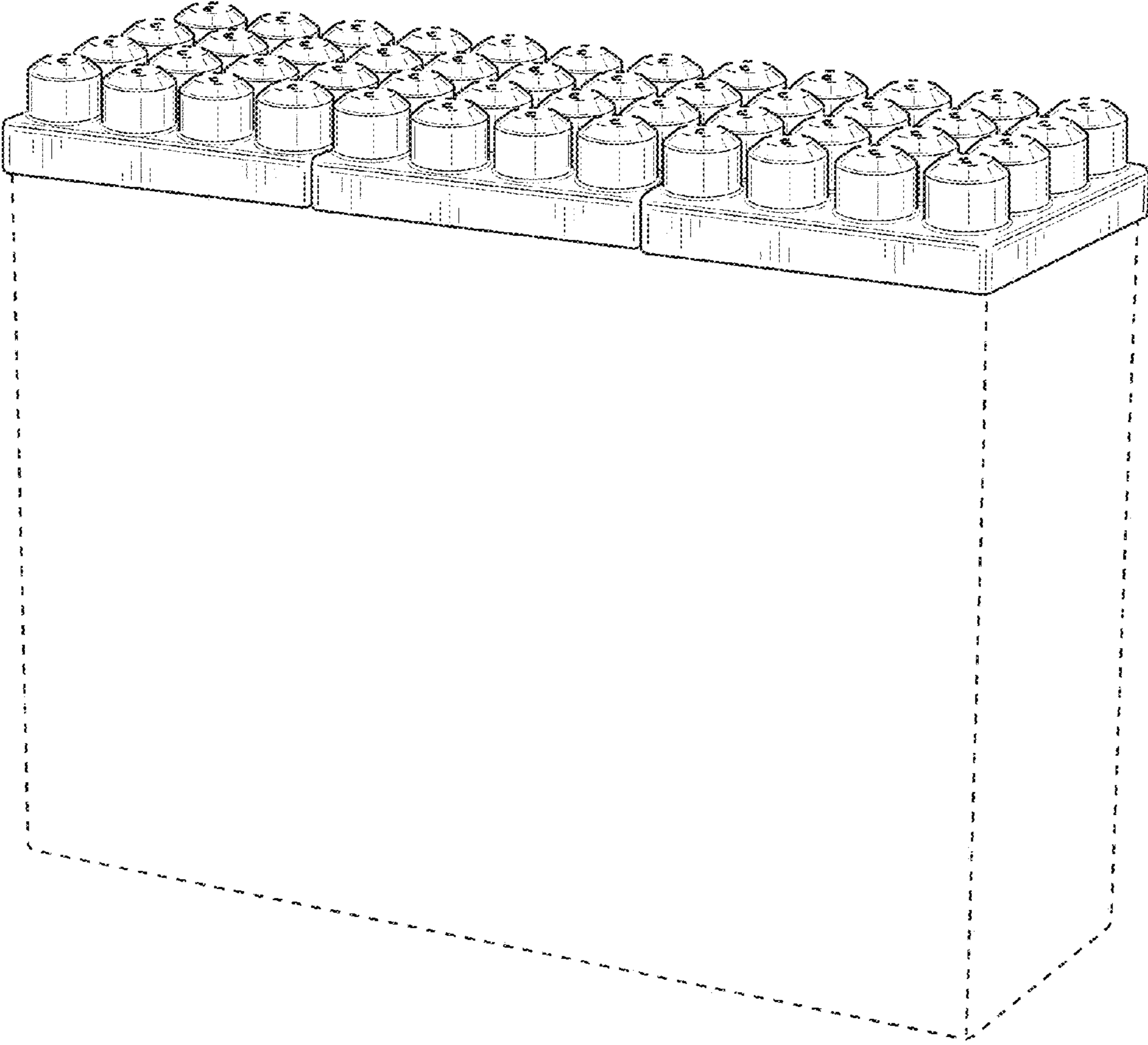


**FIG. 13**



**FIG. 14**





**FIG. 15**

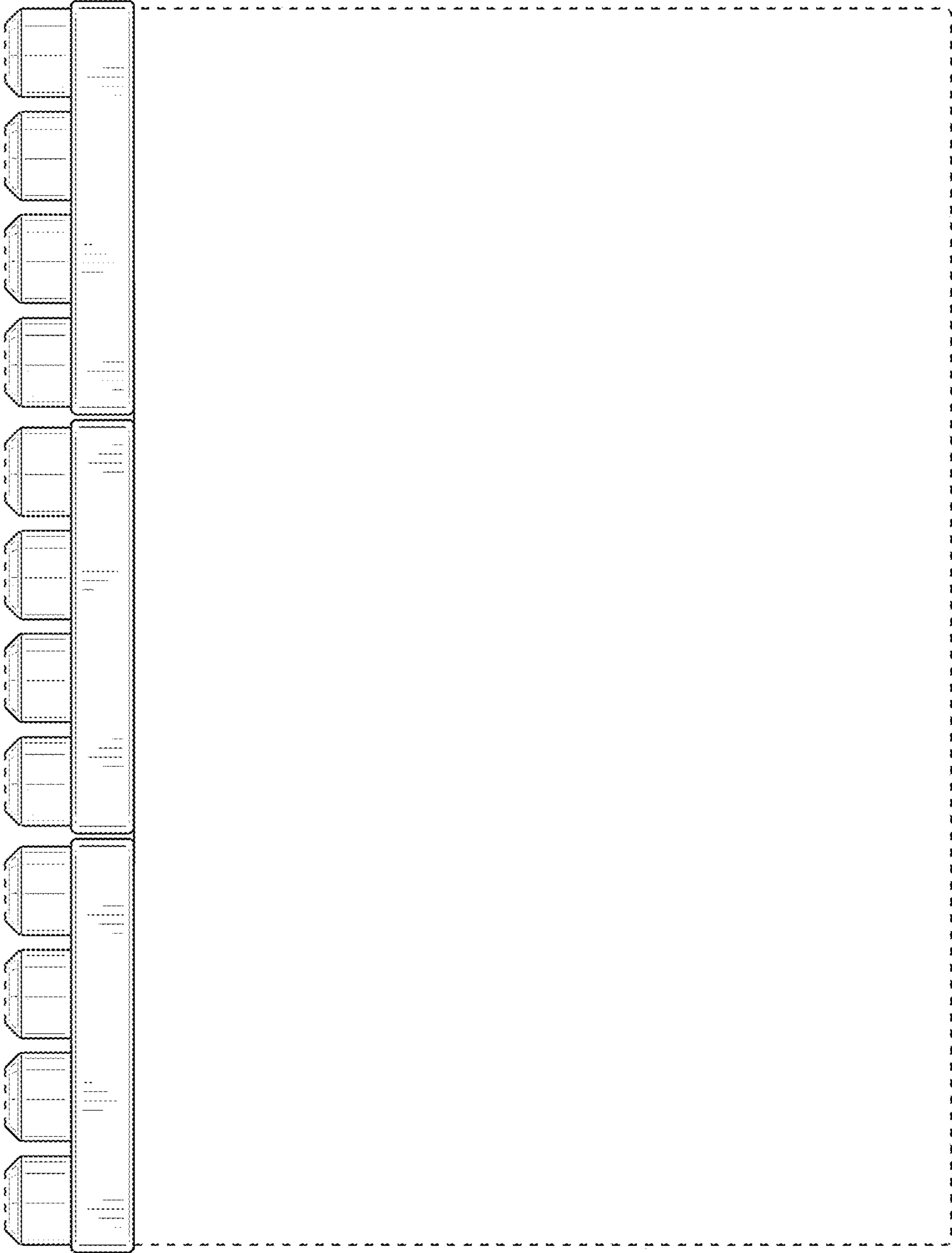
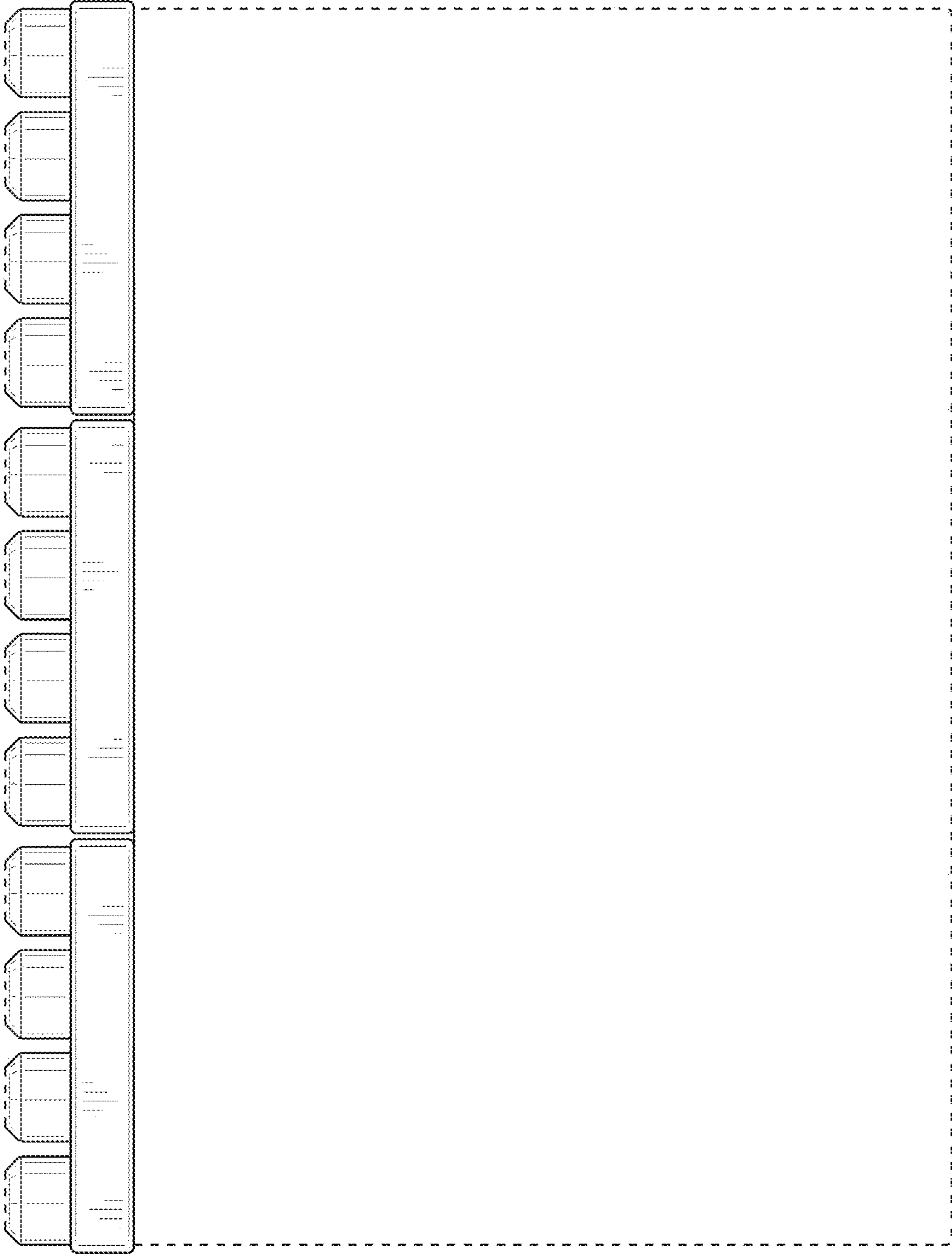
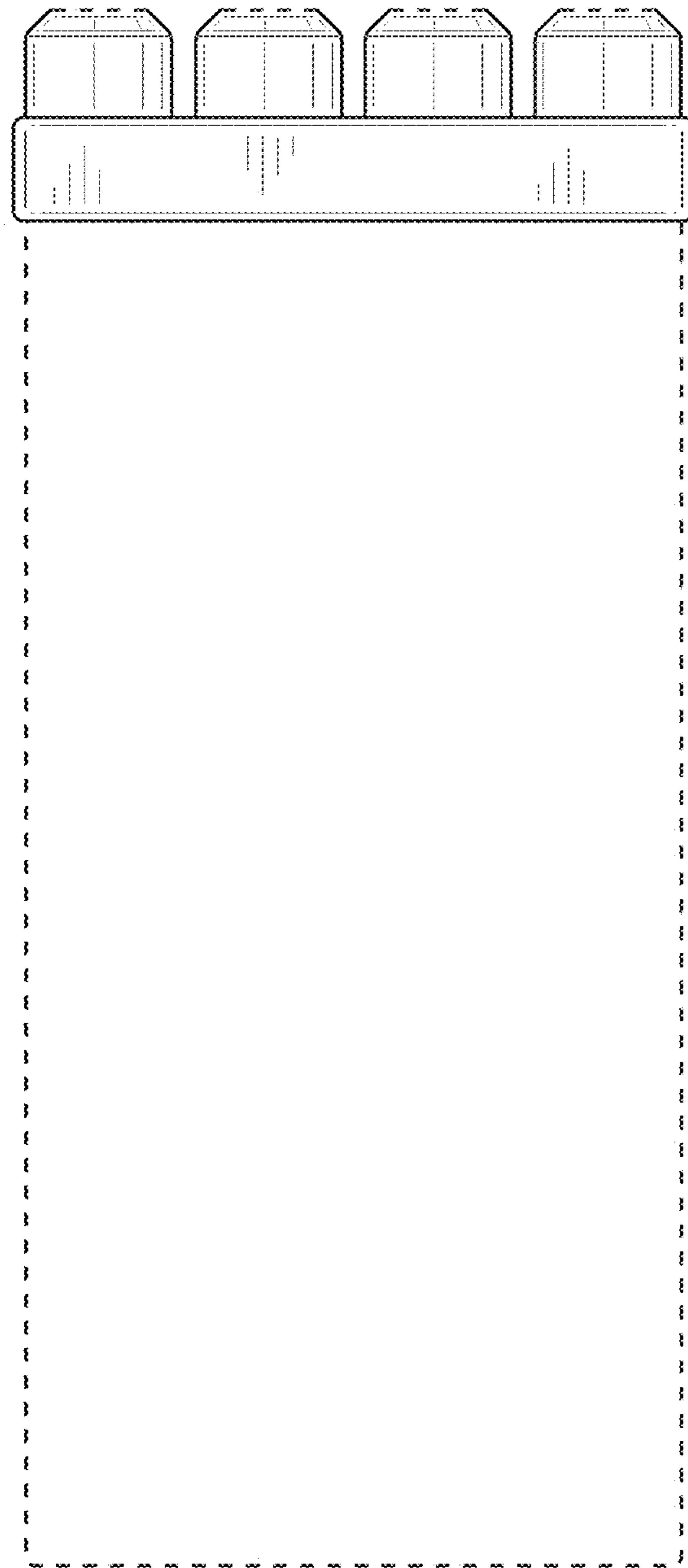


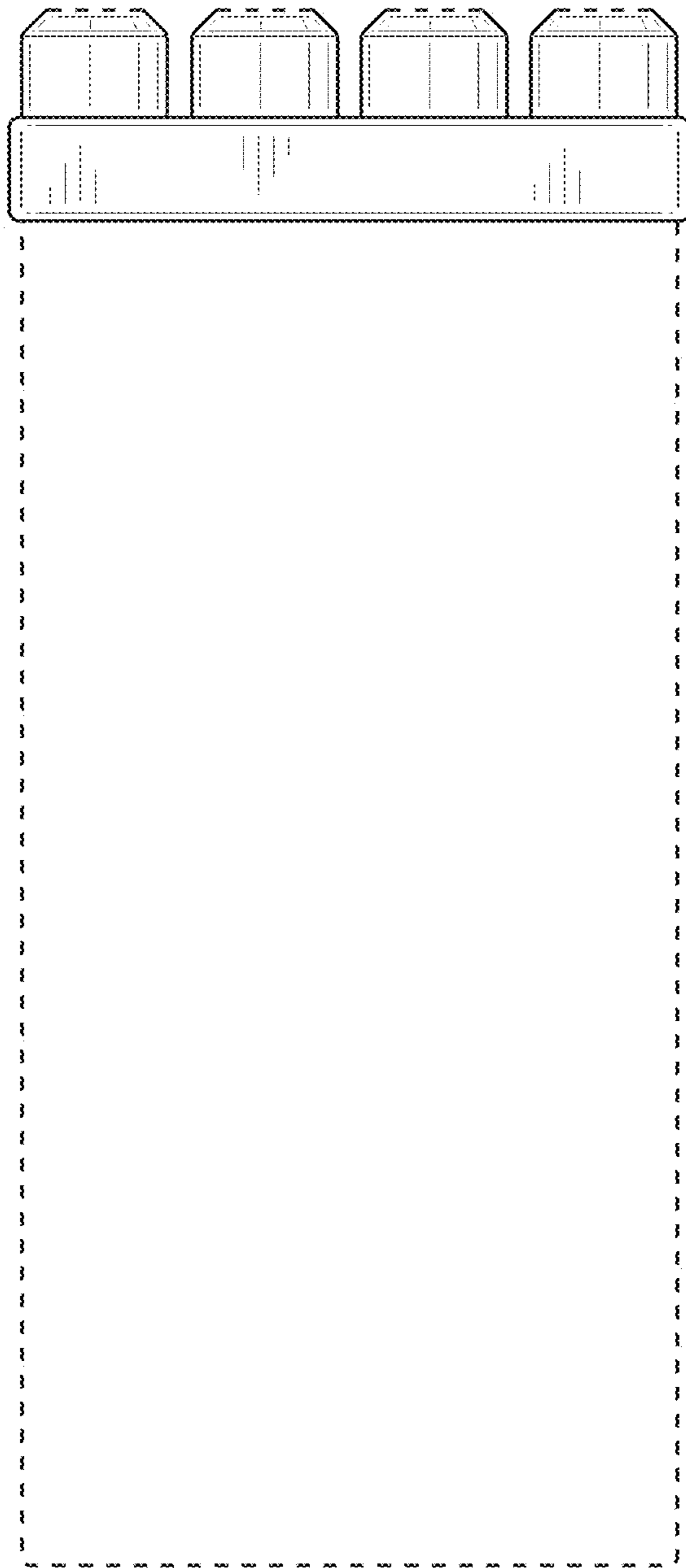
FIG. 16



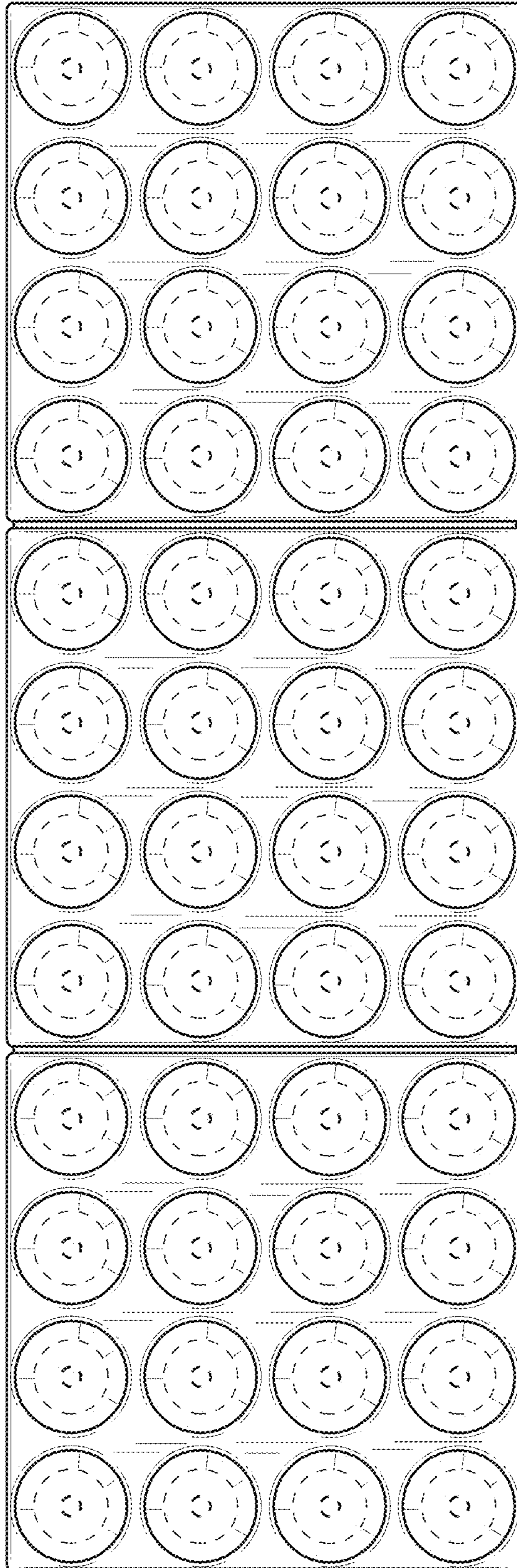
**FIG. 17**



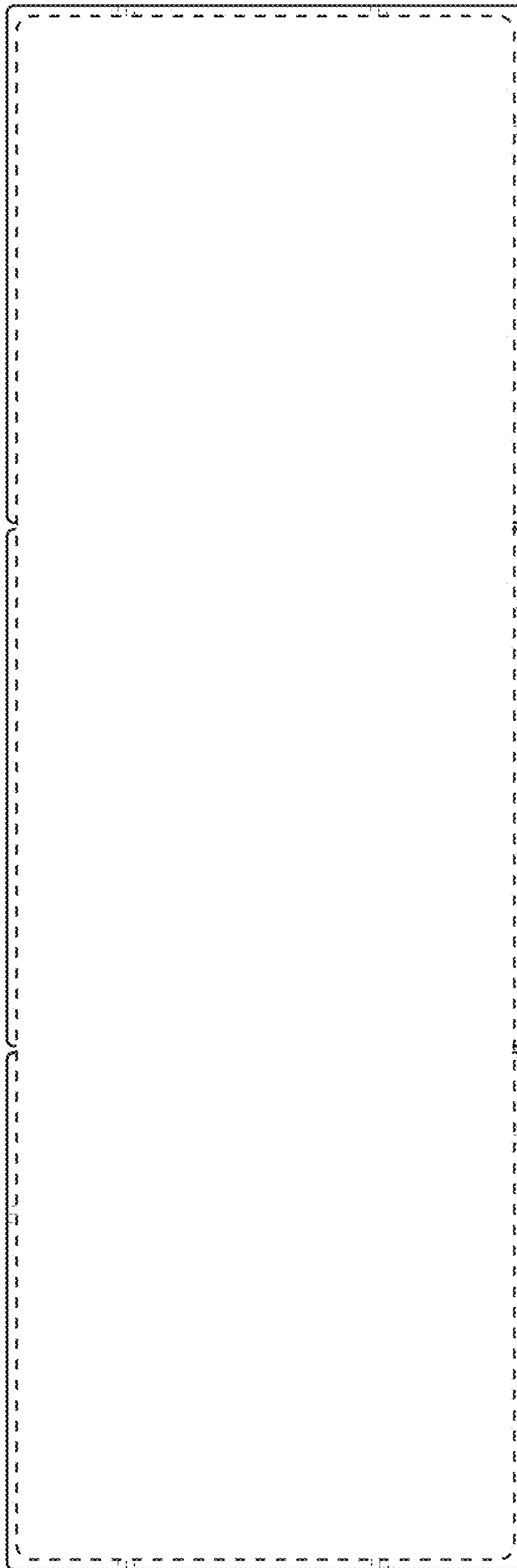
**FIG. 18**



**FIG. 19**



**FIG. 20**



**FIG. 21**