



US00D750484S

(12) **United States Design Patent**  
**Boston et al.**

(10) **Patent No.:** **US D750,484 S**  
(45) **Date of Patent:** **\*\* Mar. 1, 2016**

(54) **CONTAINER WITH SURFACE  
ORNAMENTATION**

- (71) Applicant: **The Procter & Gamble Company,**  
Cincinnati, OH (US)
- (72) Inventors: **Kristen Tanya Boston,** Cincinnati, OH  
(US); **Jennifer Marie Merchant,**  
Cincinnati, OH (US); **Jennifer Rebecca  
Pohlman,** Cincinnati, OH (US); **Jason  
Michael Hargis,** Bellevue, KY (US);  
**Kari Jean Young,** Cincinnati, OH (US);  
**Katherine Noelle Perez,** Cincinnati, OH  
(US); **Jean Martin Campbell,**  
Cincinnati, OH (US); **Charles Morgan  
McKee, Jr.,** Cincinnati, OH (US)
- (73) Assignee: **The Procter & Gamble Company,**  
Cincinnati, OH (US)

(\*\*) Term: **14 Years**

(21) Appl. No.: **29/490,355**

(22) Filed: **May 9, 2014**

(51) **LOC (10) Cl.** ..... **09-07**

(52) **U.S. Cl.**  
USPC ..... **D9/434**

(58) **Field of Classification Search**  
USPC ..... D5/20, 63; D9/414, 415, 419, 432, 434,  
D9/457, 500, 502-505, 516, 549, 552, 558,  
D9/561, 571; D11/95, 99; D14/485, 488,  
D14/489; D19/1, 27, 28; 206/557, 775, 776;  
215/379, 381, 382; 220/660, 669, 675;  
229/87.08, 123.1, 123.3, 221  
CPC ..... B65D 5/4204; B65D 15/08; B65D 1/34;  
B65D 65/22; B65D 2577/205; B65D 5/706;  
B65D 5/705

See application file for complete search history.

(56) **References Cited**

U.S. PATENT DOCUMENTS

D76,288 S *	9/1928	Coppock .....	D5/63
D79,888 S *	11/1929	MacMillan .....	D9/432
D259,472 S *	6/1981	Grodin .....	D9/432
D587,111 S *	2/2009	Seol et al. ....	D9/432
D590,250 S *	4/2009	Seol .....	D9/432
D590,253 S *	4/2009	Seol et al. ....	D9/432
D598,759 S *	8/2009	Hilliard et al. ....	D9/516
D599,201 S *	9/2009	Seol et al. ....	D9/432
D603,701 S *	11/2009	Seol et al. ....	D9/432
D608,636 S *	1/2010	Seol .....	D9/432
D655,156 S *	3/2012	Schrimpf et al. ....	D9/432
D656,016 S *	3/2012	Hablutz et al. ....	D9/434
D656,398 S *	3/2012	Gonzalez et al. ....	D9/434
D661,193 S *	6/2012	Merchant et al. ....	D9/516
D691,470 S	10/2013	Campbell et al.	
D691,476 S	10/2013	Campbell et al.	
D691,887 S	10/2013	Campbell et al.	
D692,299 S	10/2013	Campbell et al.	
D699,147 S *	2/2014	Fissell .....	D11/95
D703,532 S *	4/2014	Merchant et al. ....	D9/434
D704,059 S *	5/2014	Glass et al. ....	D9/457
D714,141 S *	9/2014	Robinson .....	D9/434
D723,915 S *	3/2015	Abel et al. ....	D9/434

\* cited by examiner

*Primary Examiner* — Robert M Spear

*Assistant Examiner* — Darcey E Heflin

(74) *Attorney, Agent, or Firm* — Alexandra S. Anoff

(57) **CLAIM**

The ornamental design for a container with surface ornamentation, as shown and described.

**DESCRIPTION**

The present application file contains at least one drawing executed in color. Copies of this patent or patent application publication with color drawing(s) will be provided by the Office upon request and payment of the necessary fee.

FIG. 1 is a perspective view of a container with surface ornamentation embodying our new design;

FIG. 2 is a front view thereof;

FIG. 3 is a right side view thereof;

FIG. 4 is a rear view thereof;

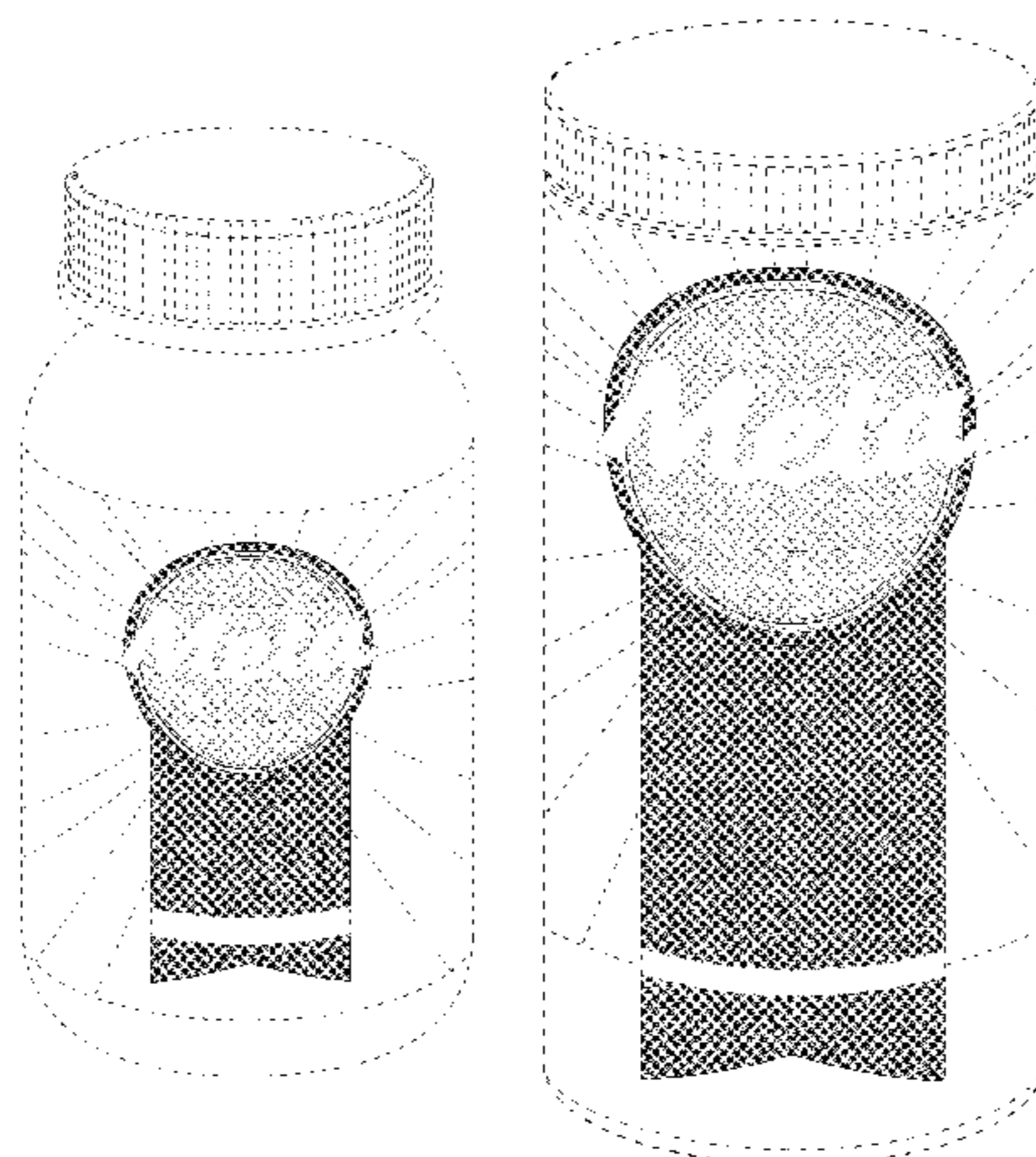

FIG. 5 is a left side view thereof;  
FIG. 6 is a top view thereof;  
FIG. 7 is a bottom view thereof;  
FIG. 8 is a perspective view of a second embodiment of a container with surface ornamentation embodying our new design;  
FIG. 9 is a front view thereof;  
FIG. 10 is a right side view thereof;  
FIG. 11 is rear view thereof;  
FIG. 12 is a left side view thereof;  
FIG. 13 is a top view thereof;  
FIG. 14 is a bottom view thereof;  
FIG. 15 is a perspective view of a third embodiment of a container with surface ornamentation embodying our new design;  
FIG. 16 is a front view thereof;  
FIG. 17 is a right side view thereof;  
FIG. 18 is rear view thereof;  
FIG. 19 is a left side view thereof;  
FIG. 20 is a top view thereof;  
FIG. 21 is a bottom view thereof;  
FIG. 22 is a perspective view of a fourth embodiment of a container with surface ornamentation embodying our new design;  
FIG. 23 is a front view thereof;  
FIG. 24 is a left side view thereof;

FIG. 25 is rear view thereof;  
FIG. 26 is a right side view thereof;  
FIG. 27 is a top view thereof;  
FIG. 28 is a bottom view thereof;  
FIG. 29 is a perspective view of a fifth embodiment of a container with surface ornamentation embodying our new design;  
FIG. 30 is a front view thereof;  
FIG. 31 is a left side view thereof;  
FIG. 32 is rear view thereof;  
FIG. 33 is a right side view thereof;  
FIG. 34 is a top view thereof;  
FIG. 35 is a bottom view thereof;  
FIG. 36 is a perspective view of a sixth embodiment of a container with surface ornamentation embodying our new design;  
FIG. 37 is a front view thereof;  
FIG. 38 is a left side view thereof;  
FIG. 39 is rear view thereof;  
FIG. 40 is a right side view thereof;  
FIG. 41 is a top view thereof; and,  
FIG. 42 is a bottom view thereof.

In the drawings, the broken lines depict environmental subject matter only that forms no part of the claim.

**1 Claim, 20 Drawing Sheets  
(8 of 20 Drawing Sheet(s) Filed in Color)**

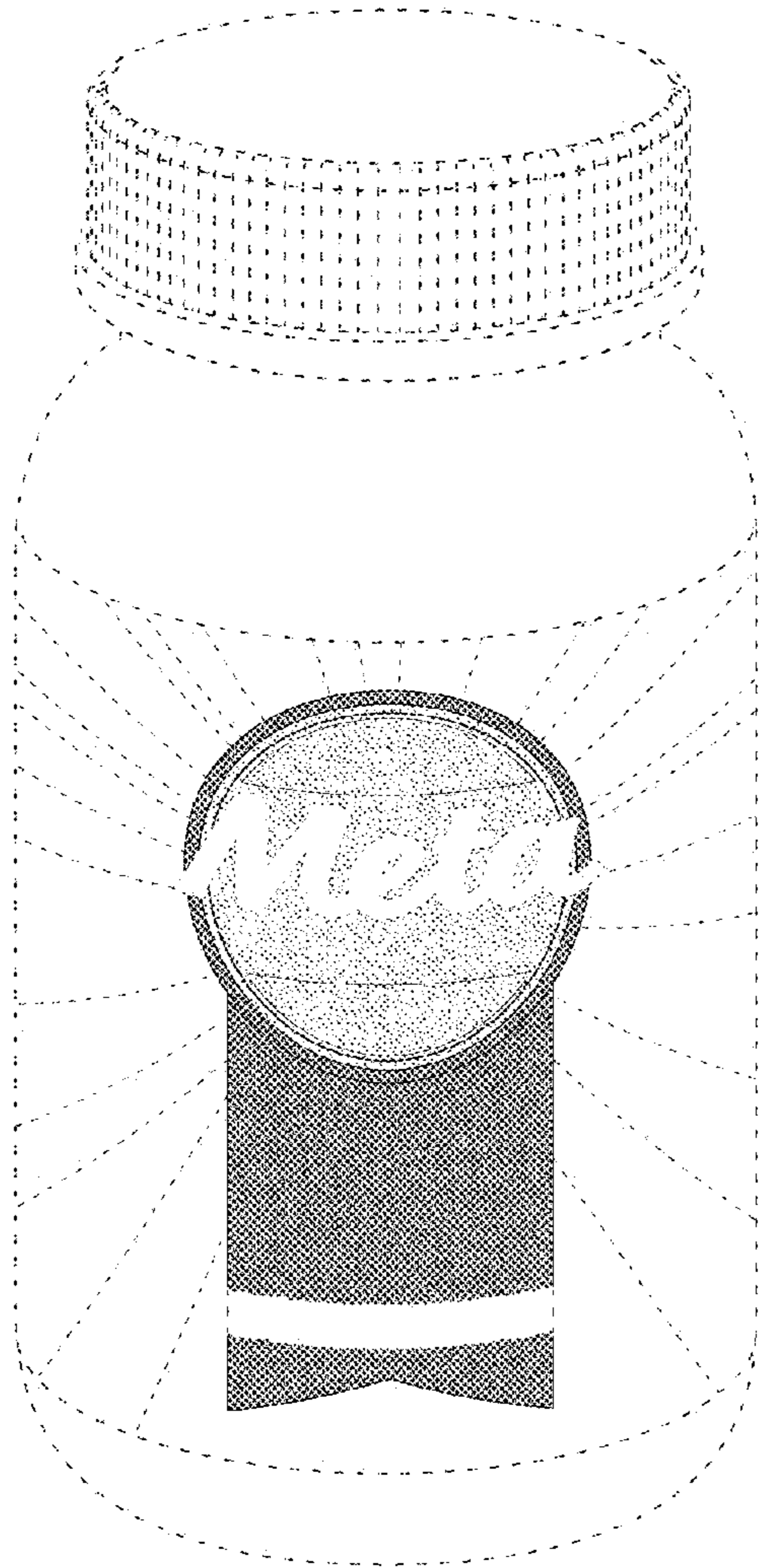

Fig. 1

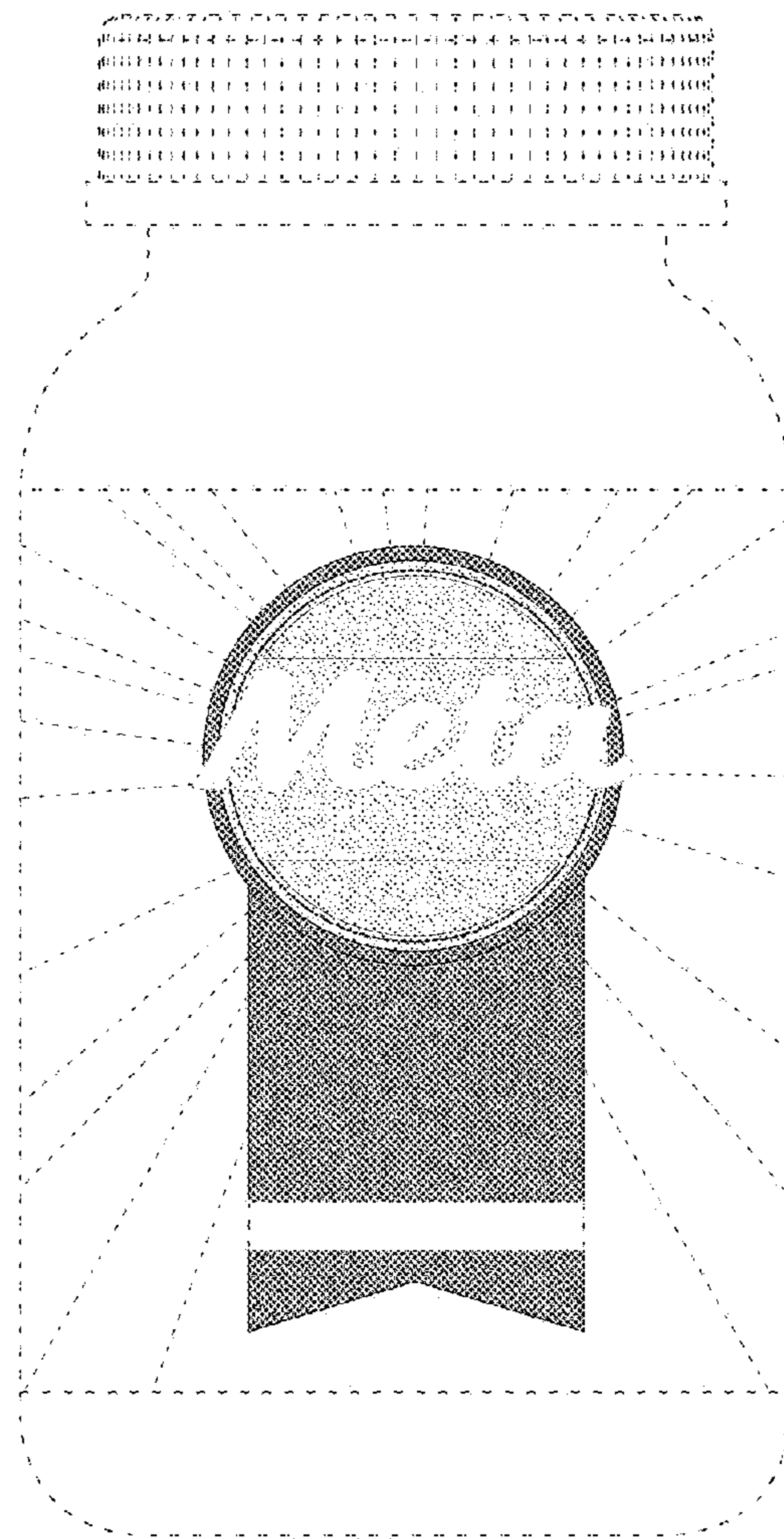

Fig. 2

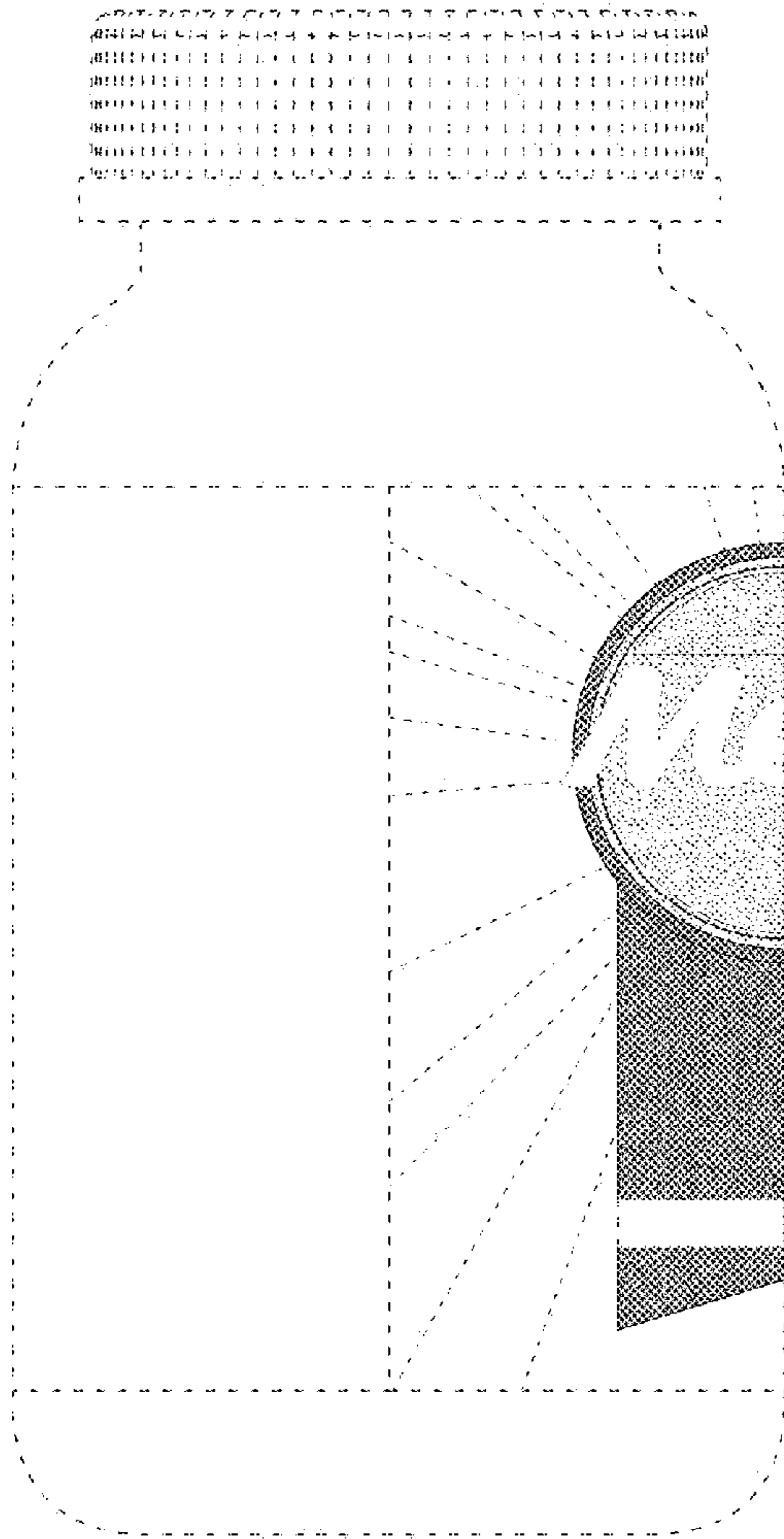

Fig. 3

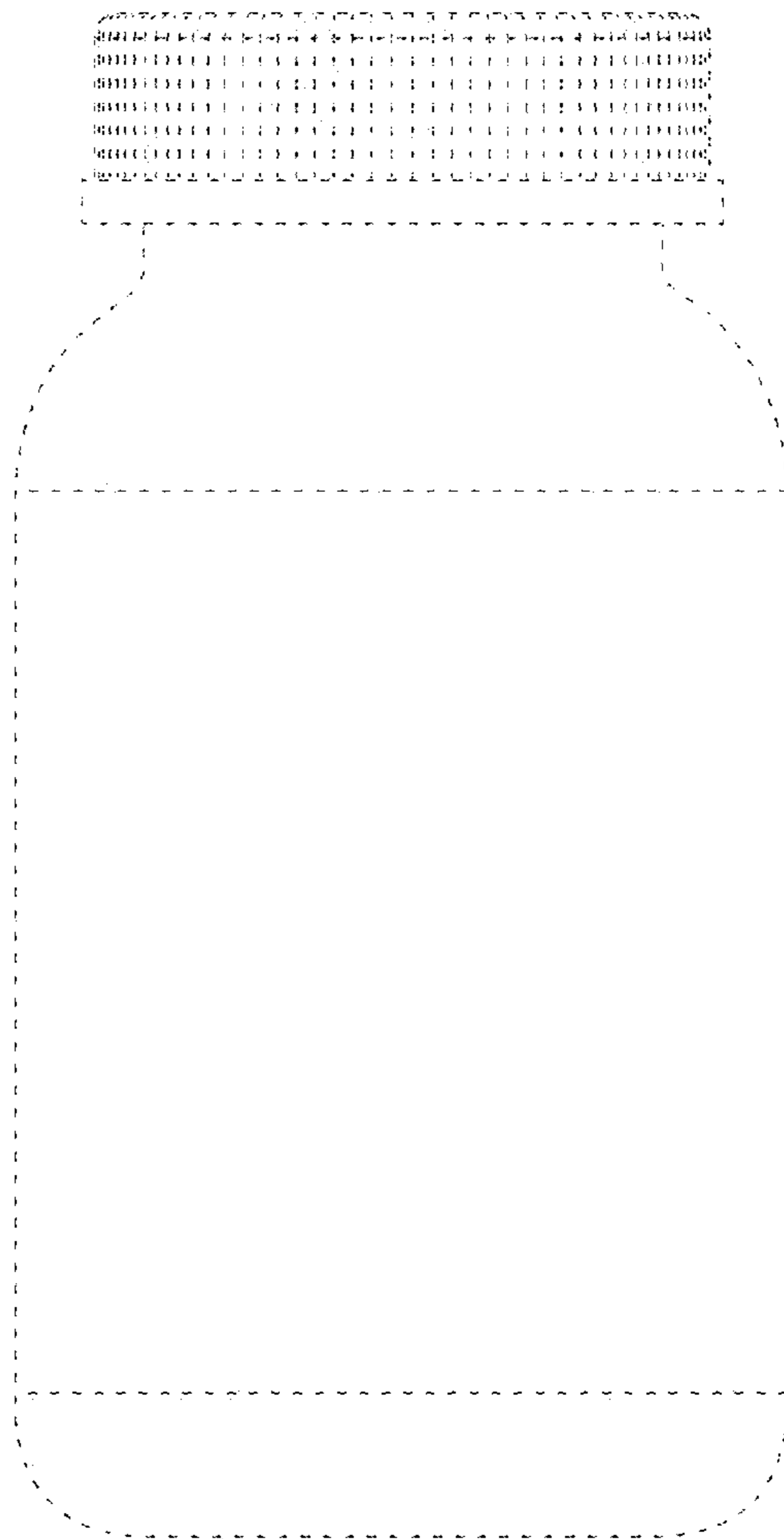

Fig. 4

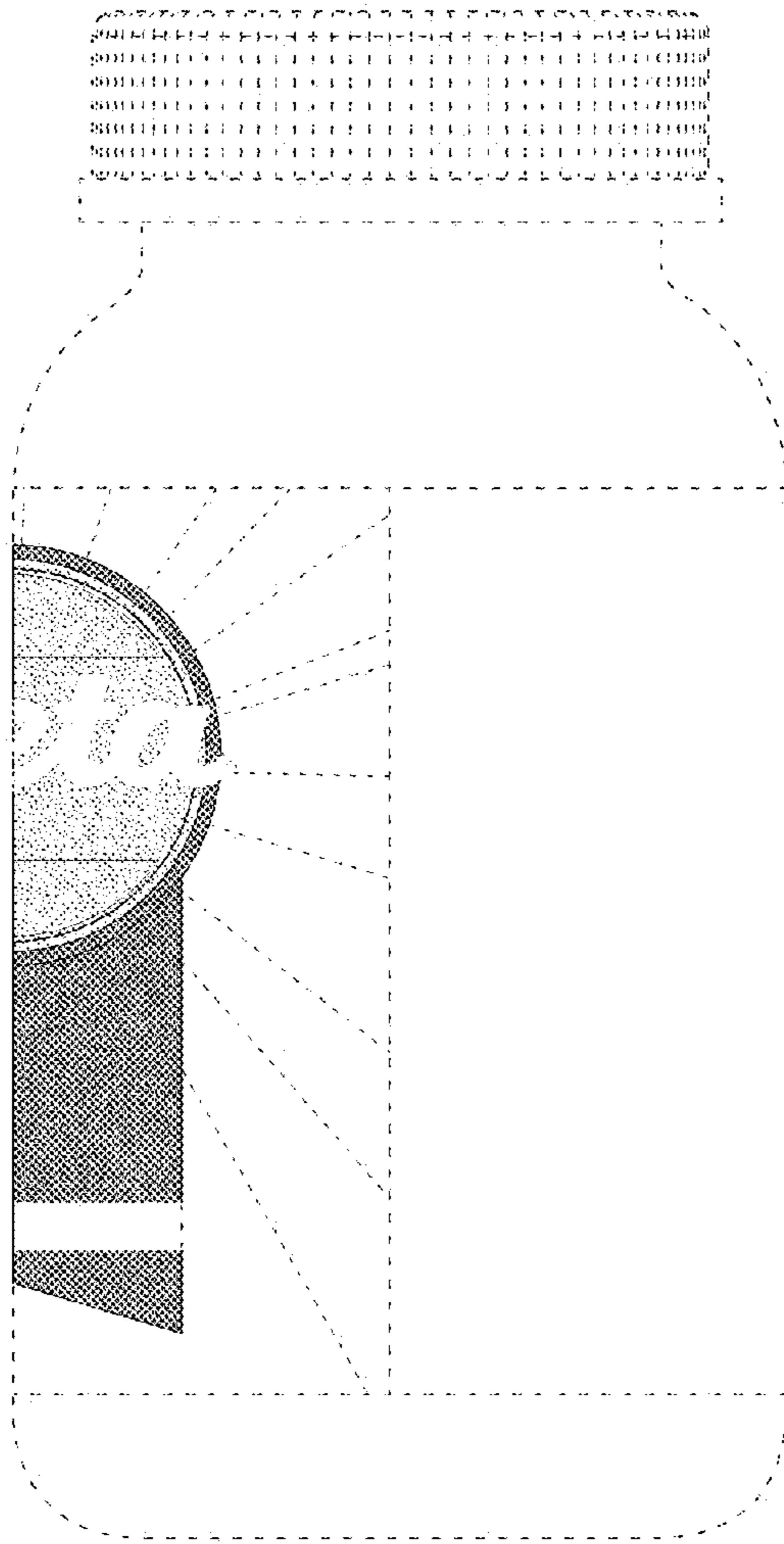

Fig. 5

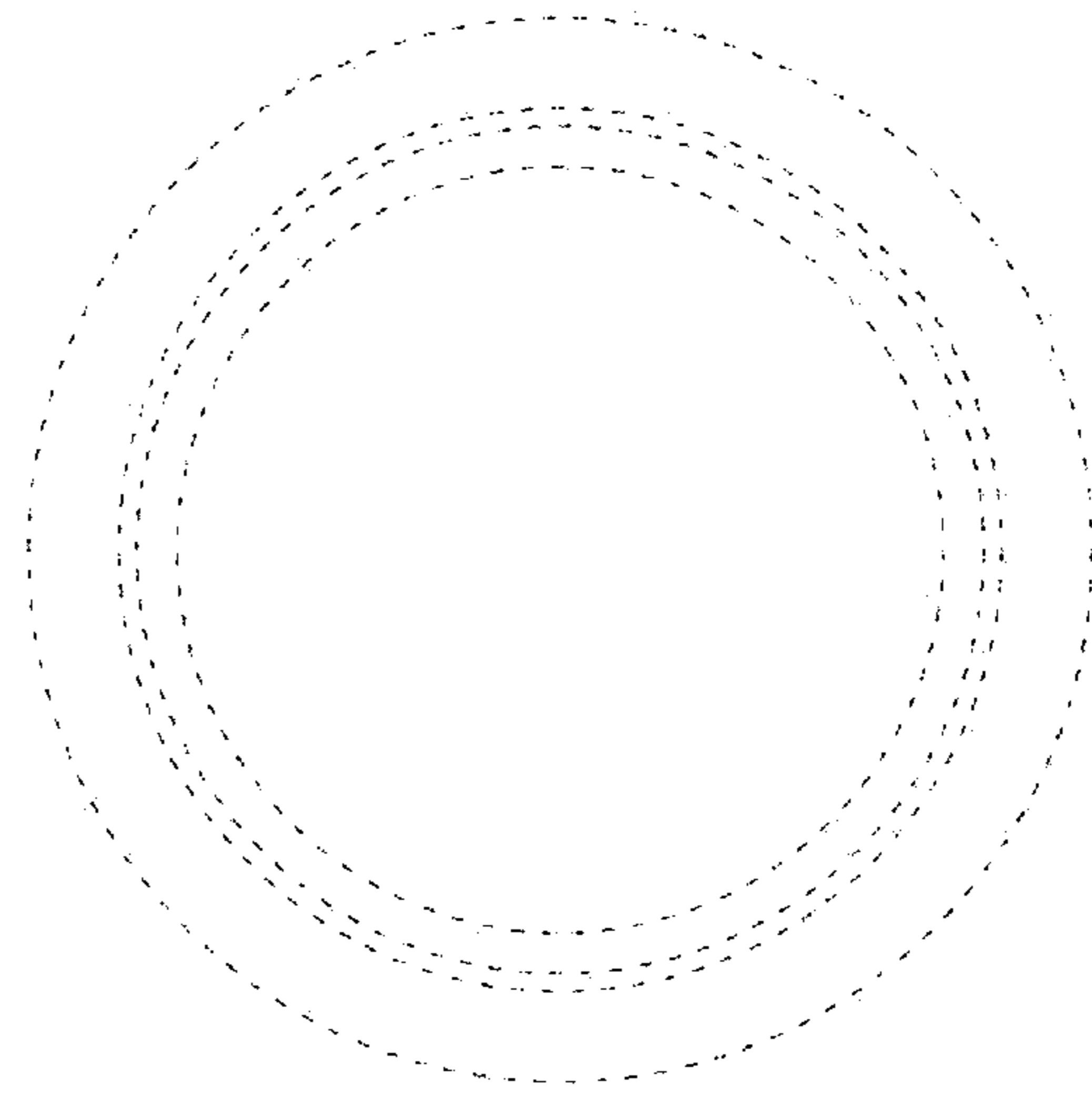

Fig. 6

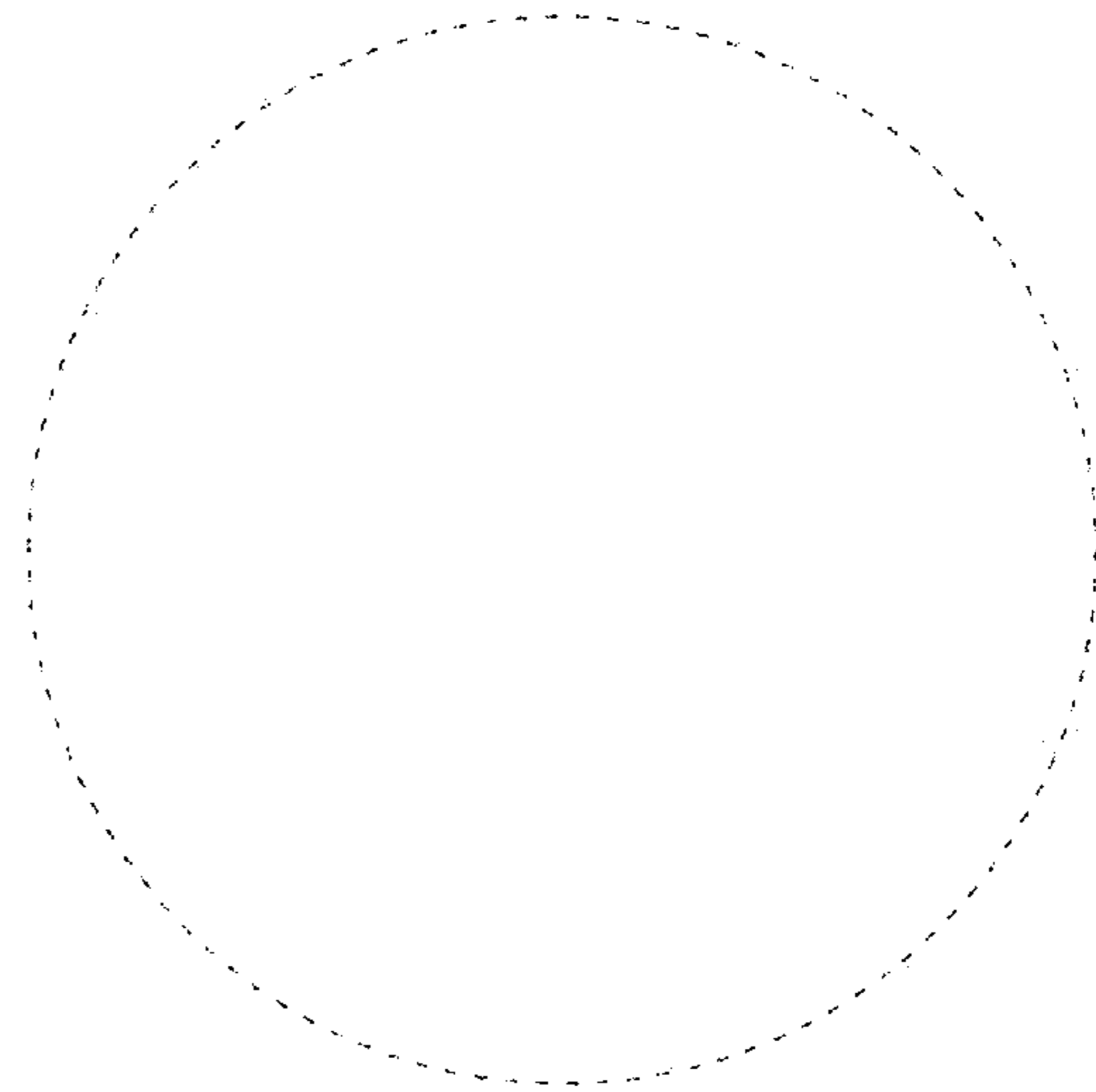

Fig. 7

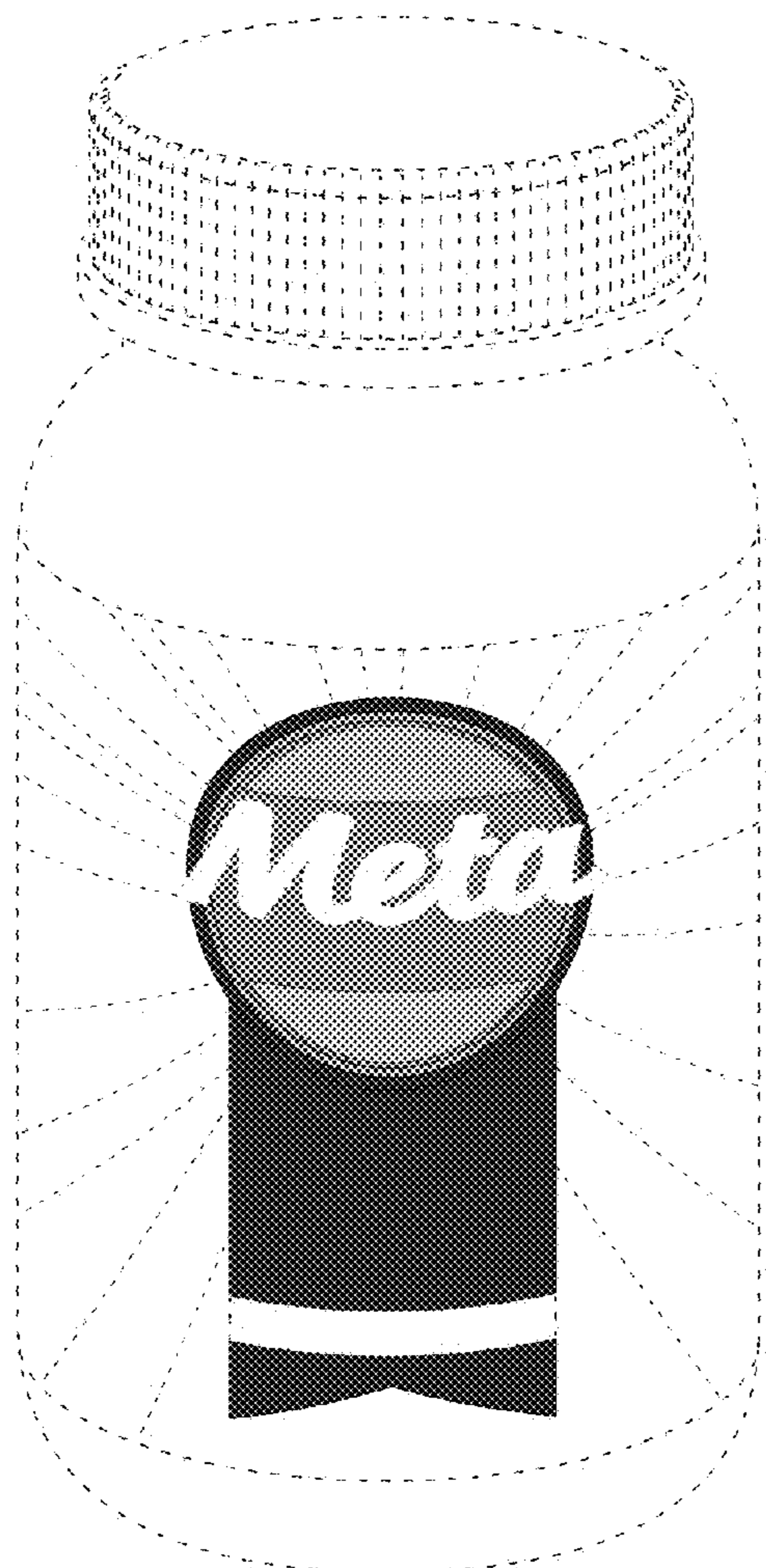

Fig. 8

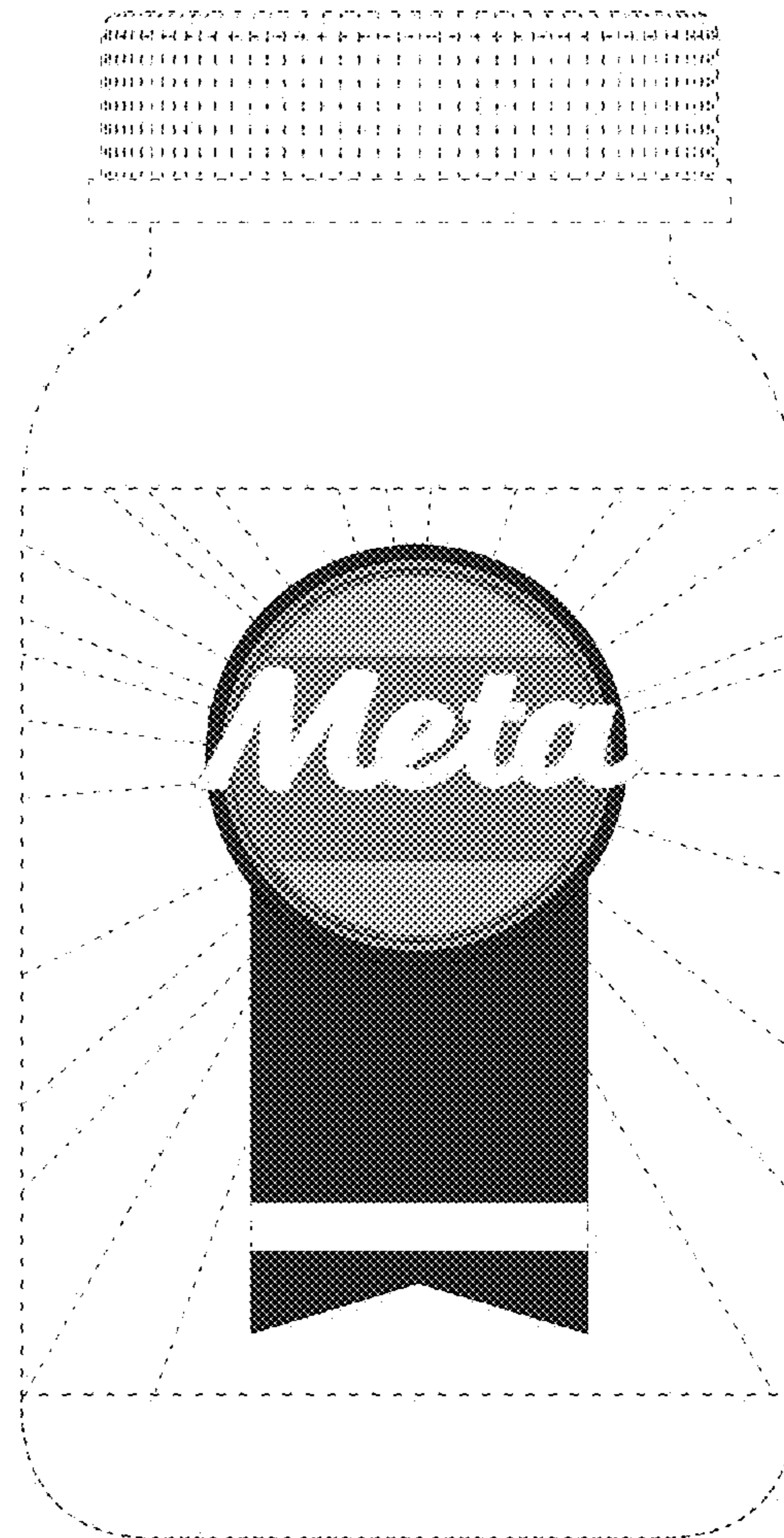

Fig. 9

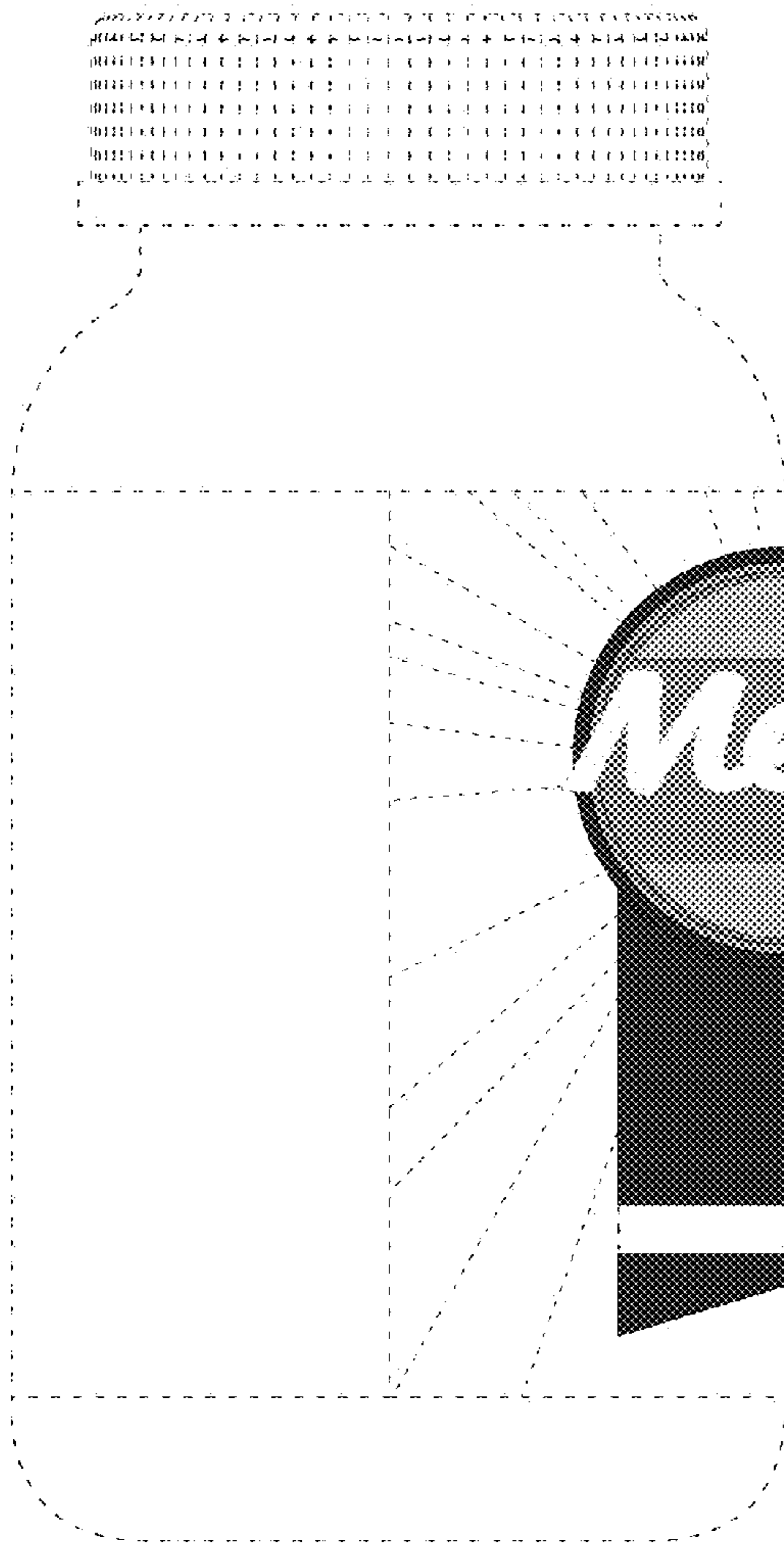

Fig. 10

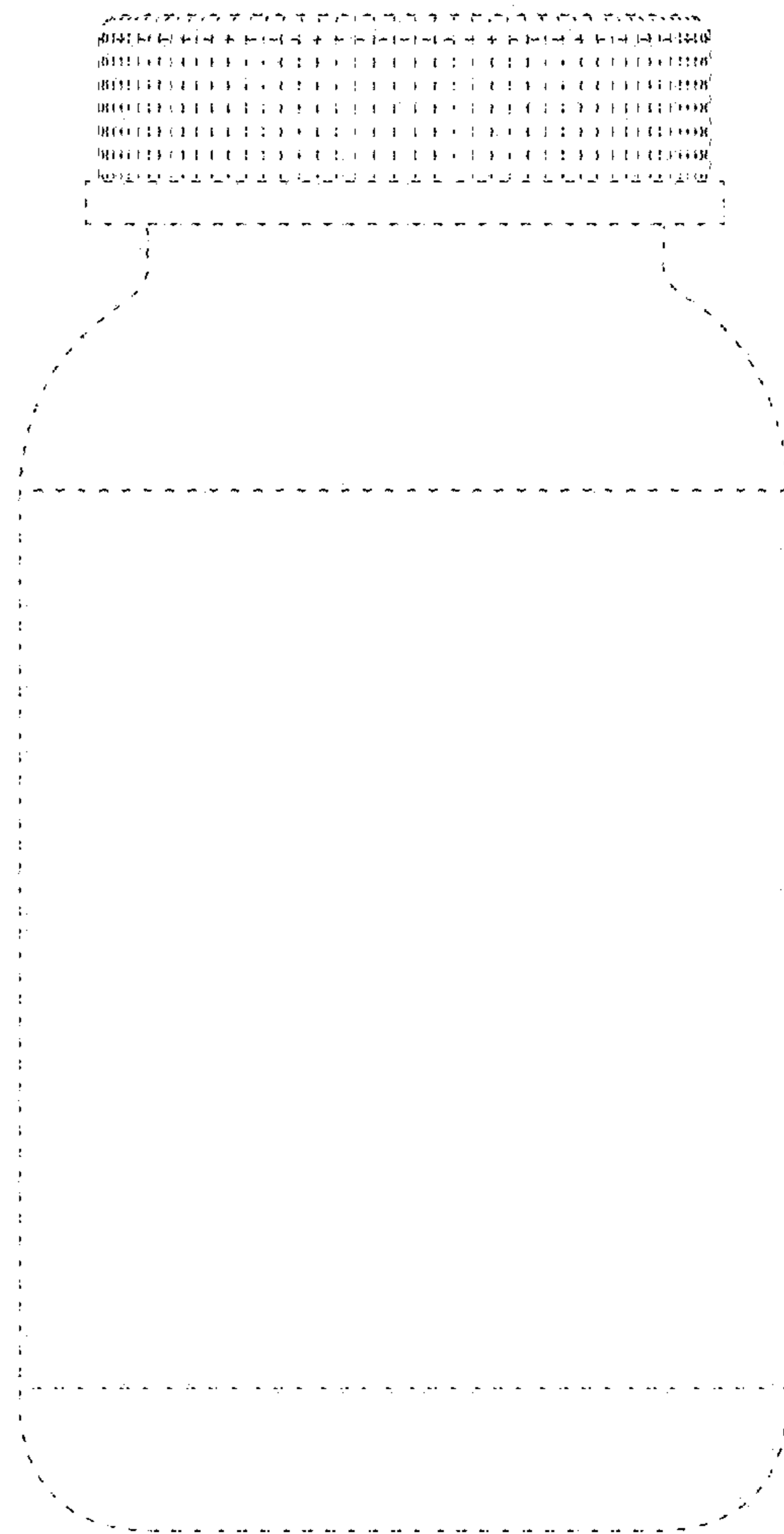

Fig. 11

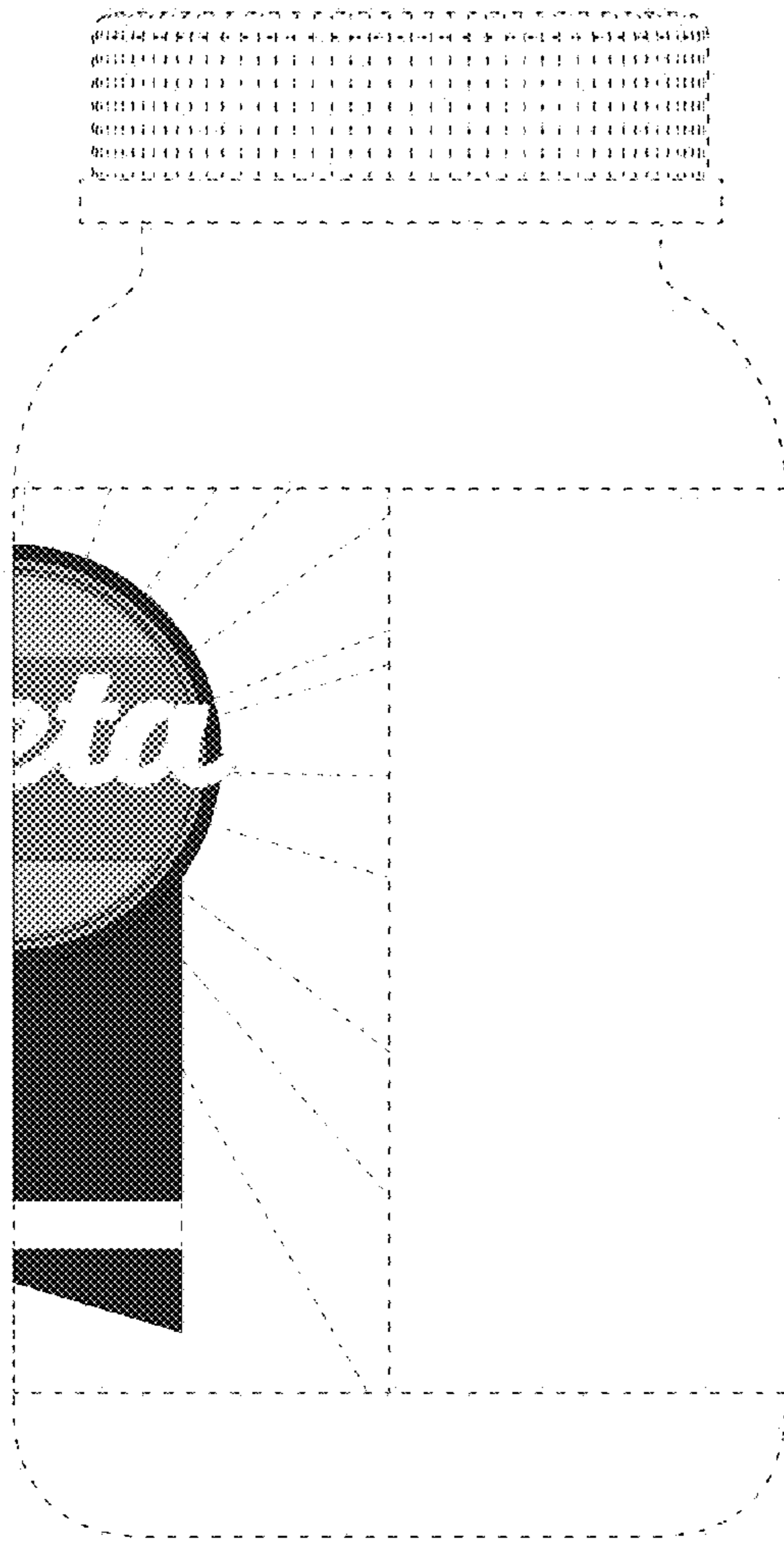

Fig. 12

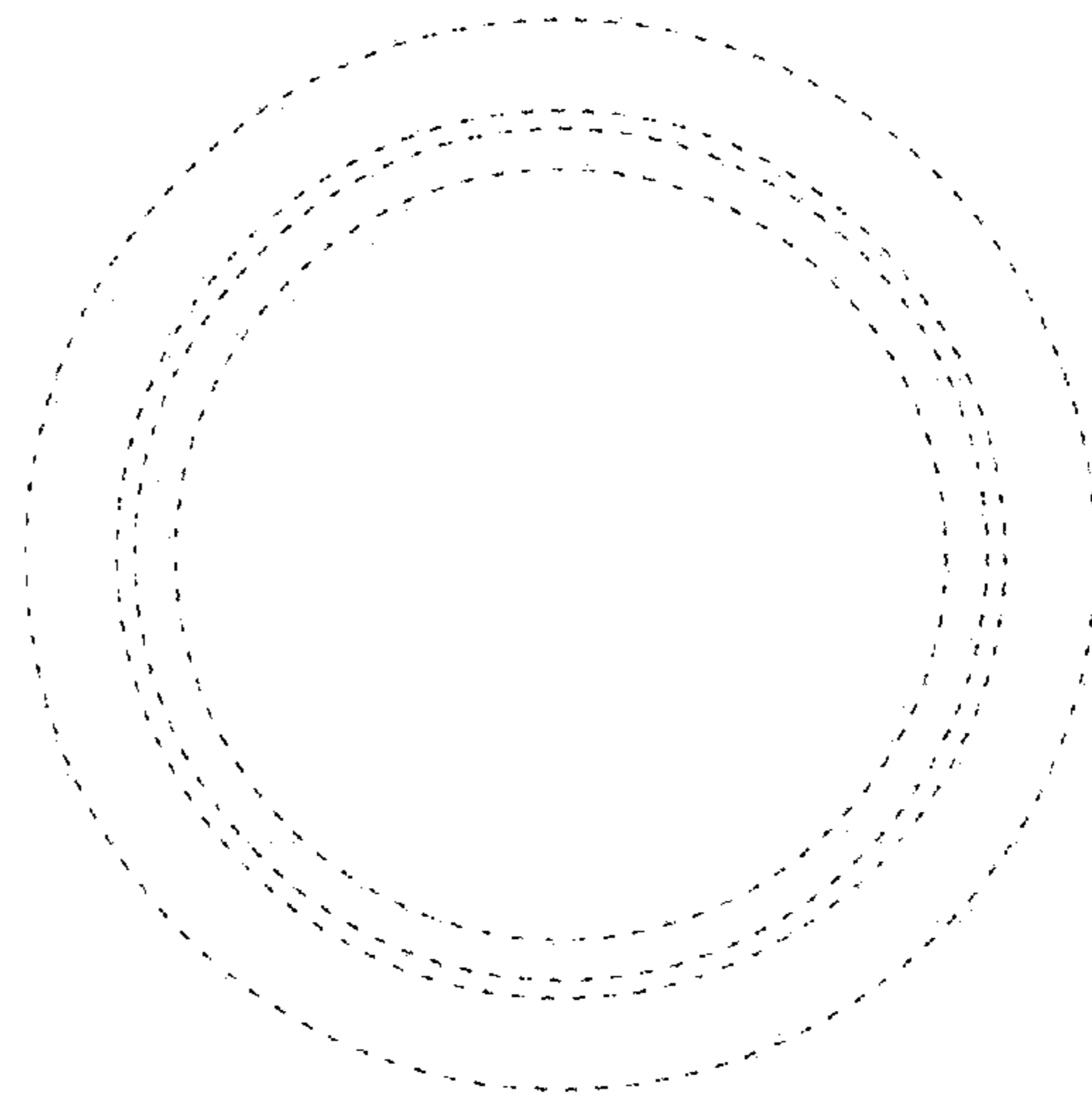

Fig. 13

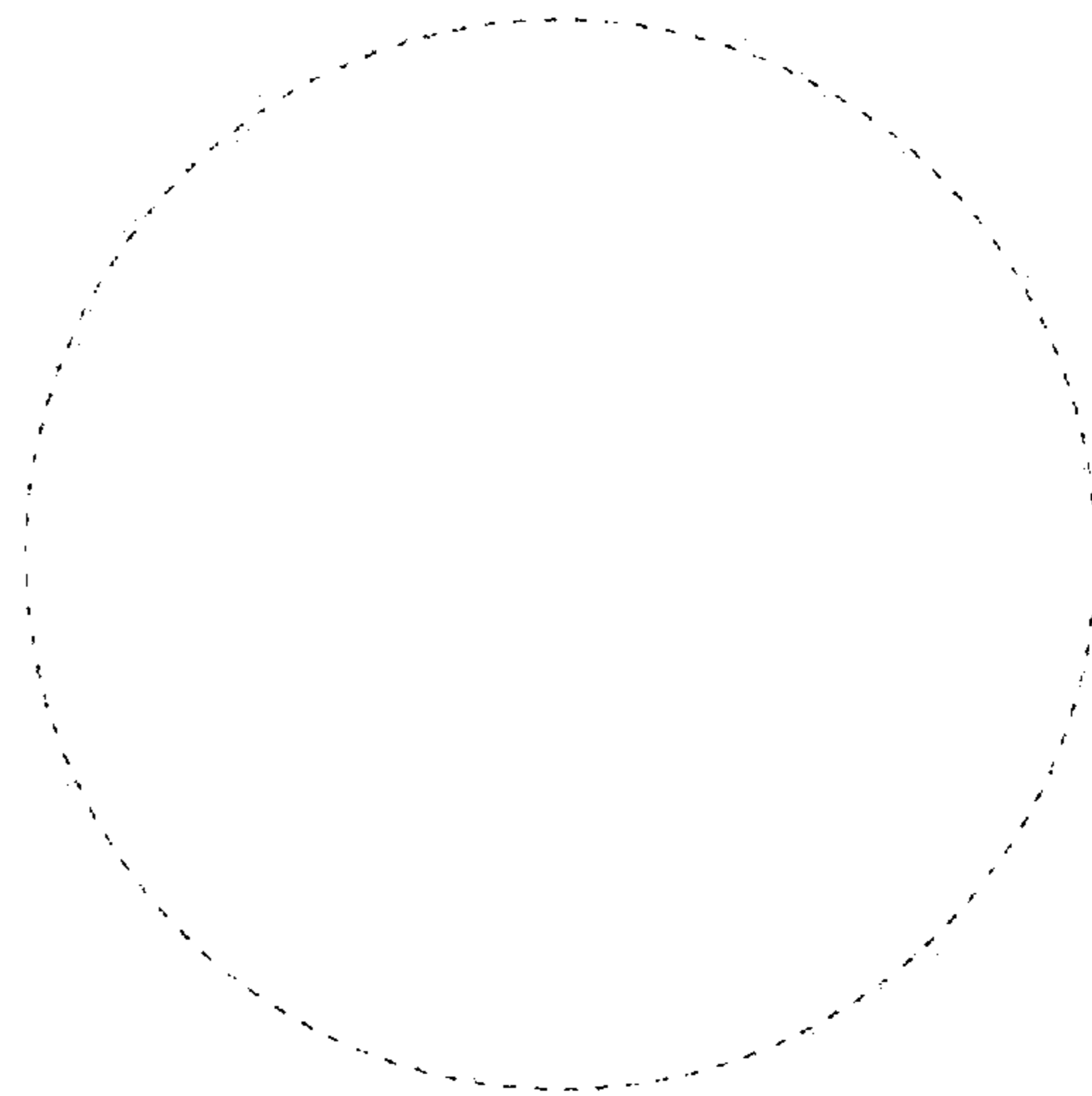

Fig. 14



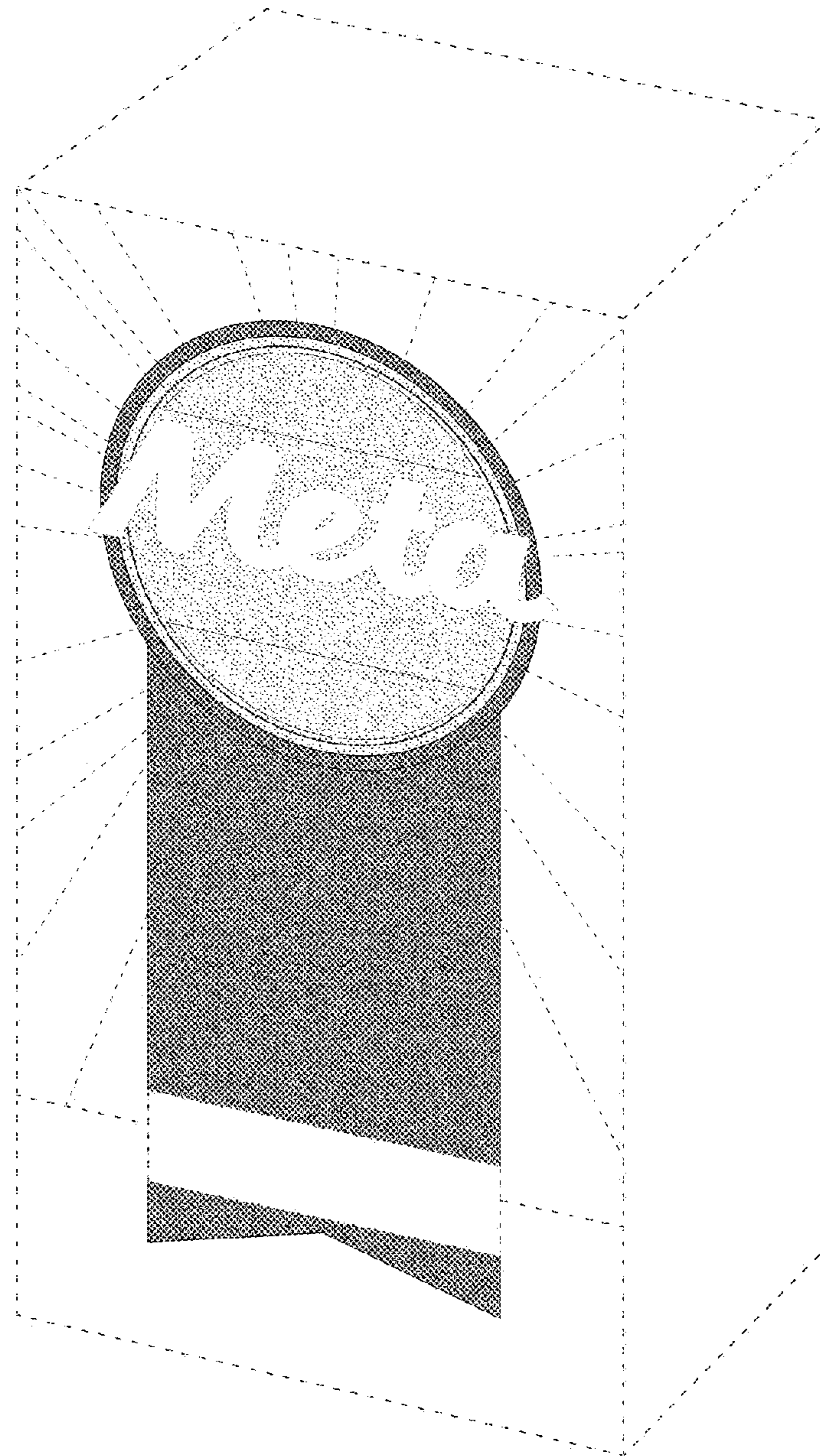

Fig. 15

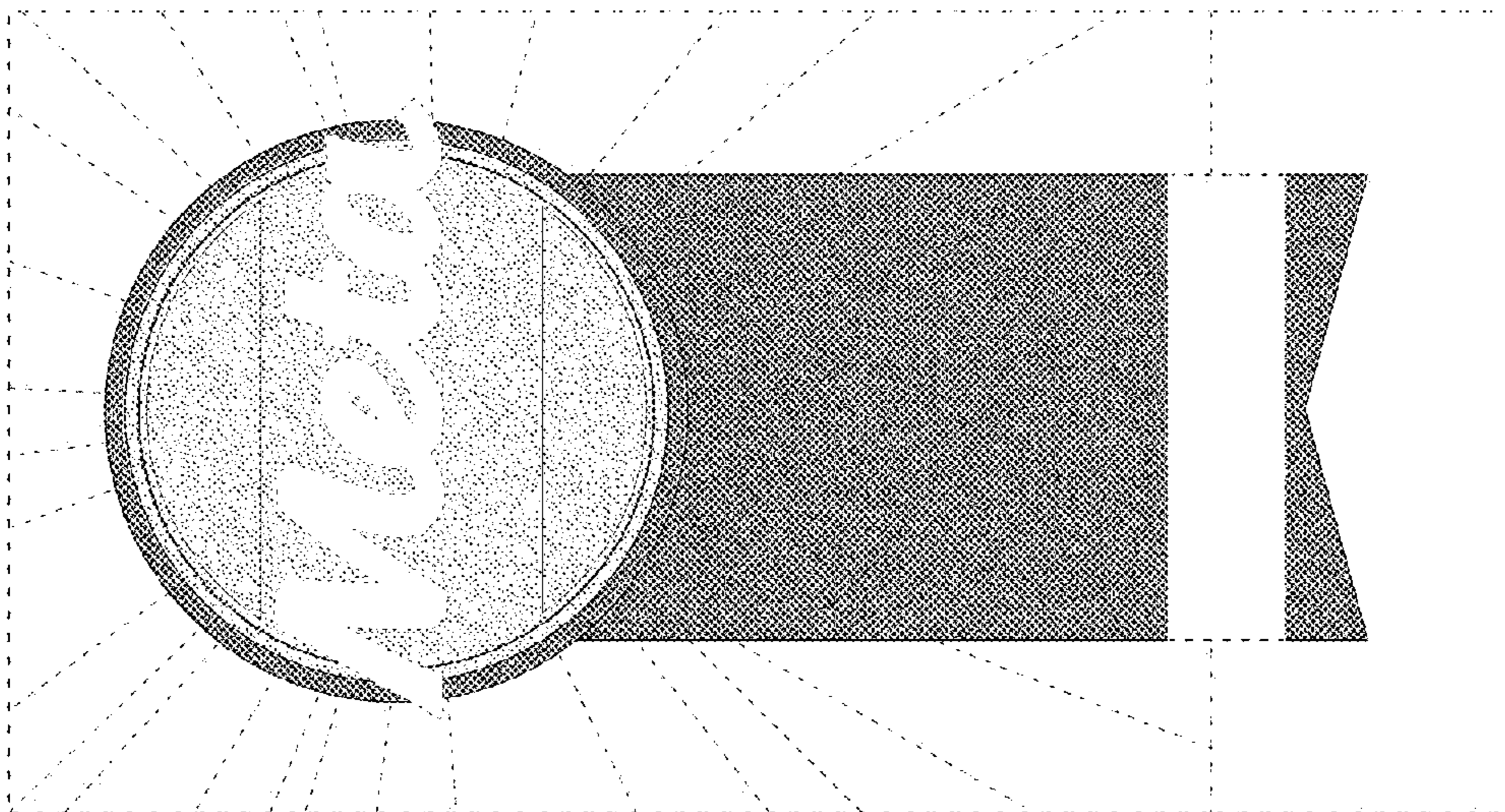

Fig. 16

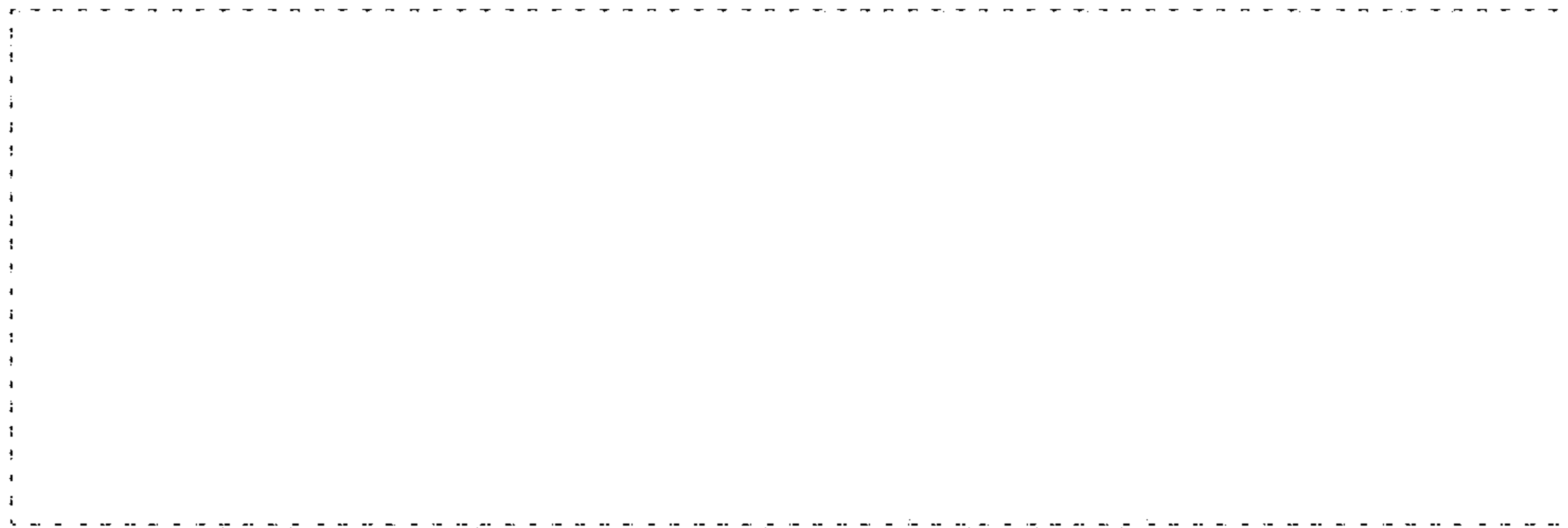

Fig. 17

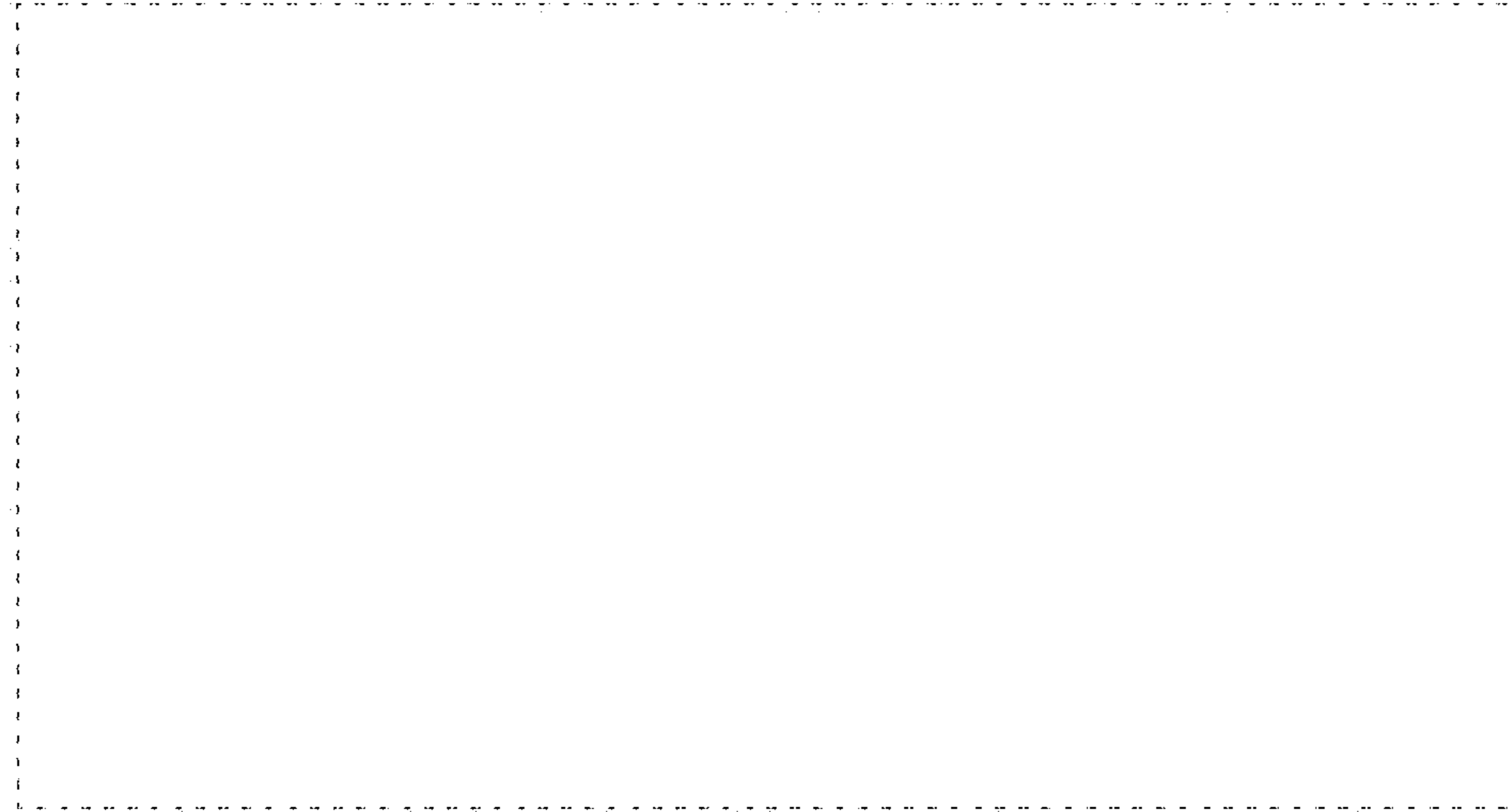

Fig. 18



Fig. 19

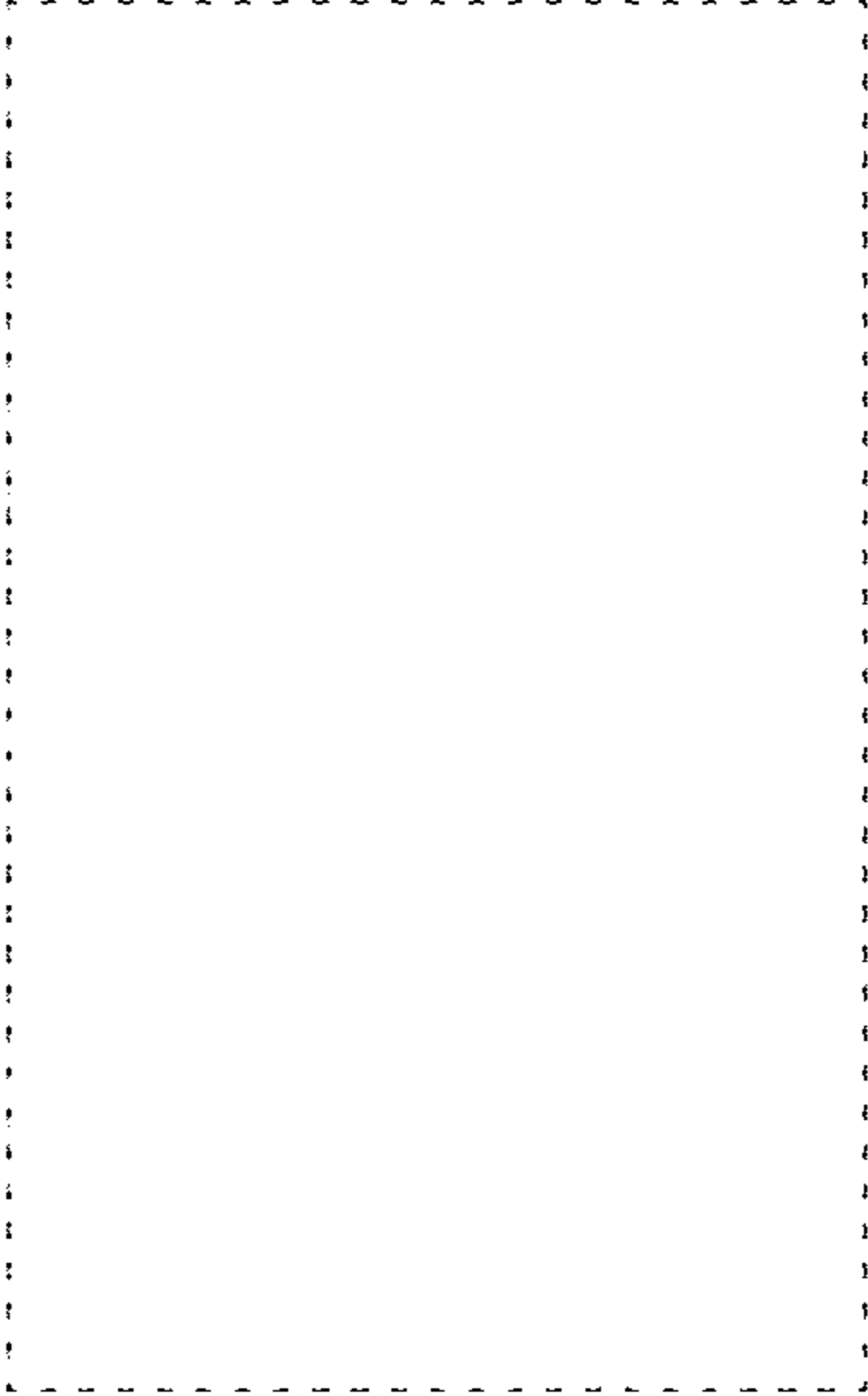

Fig. 20

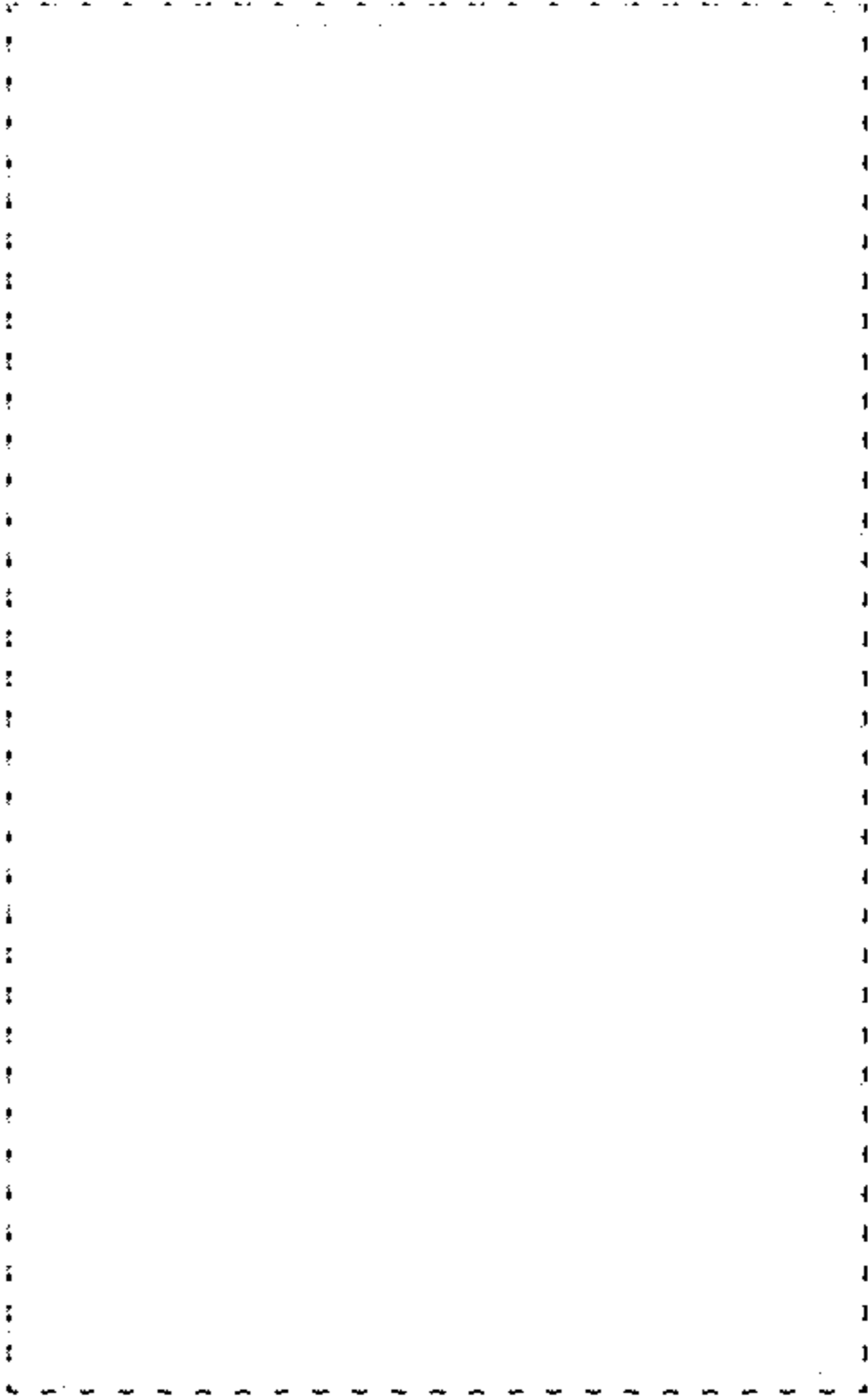

Fig. 21

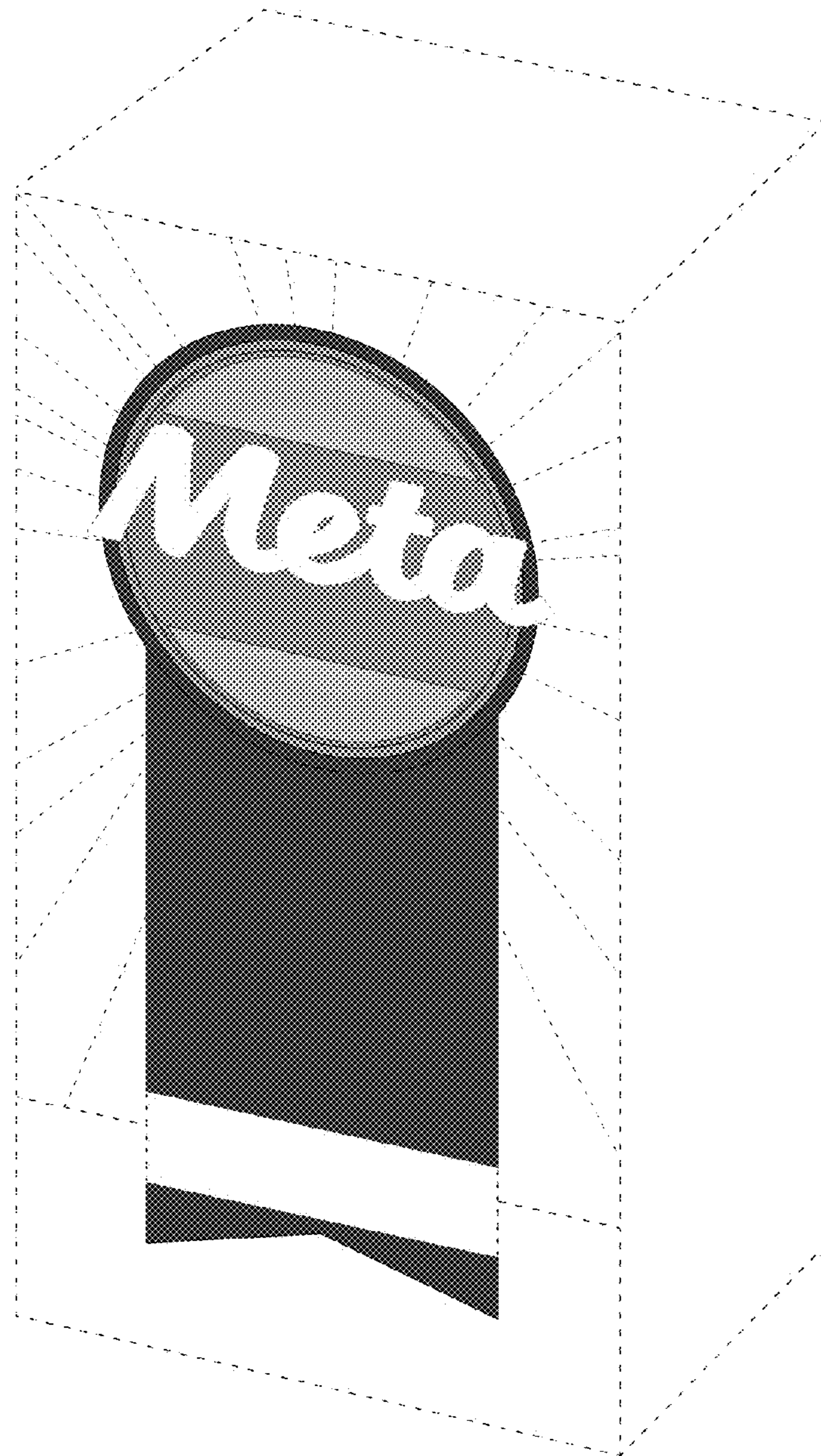

Fig. 22

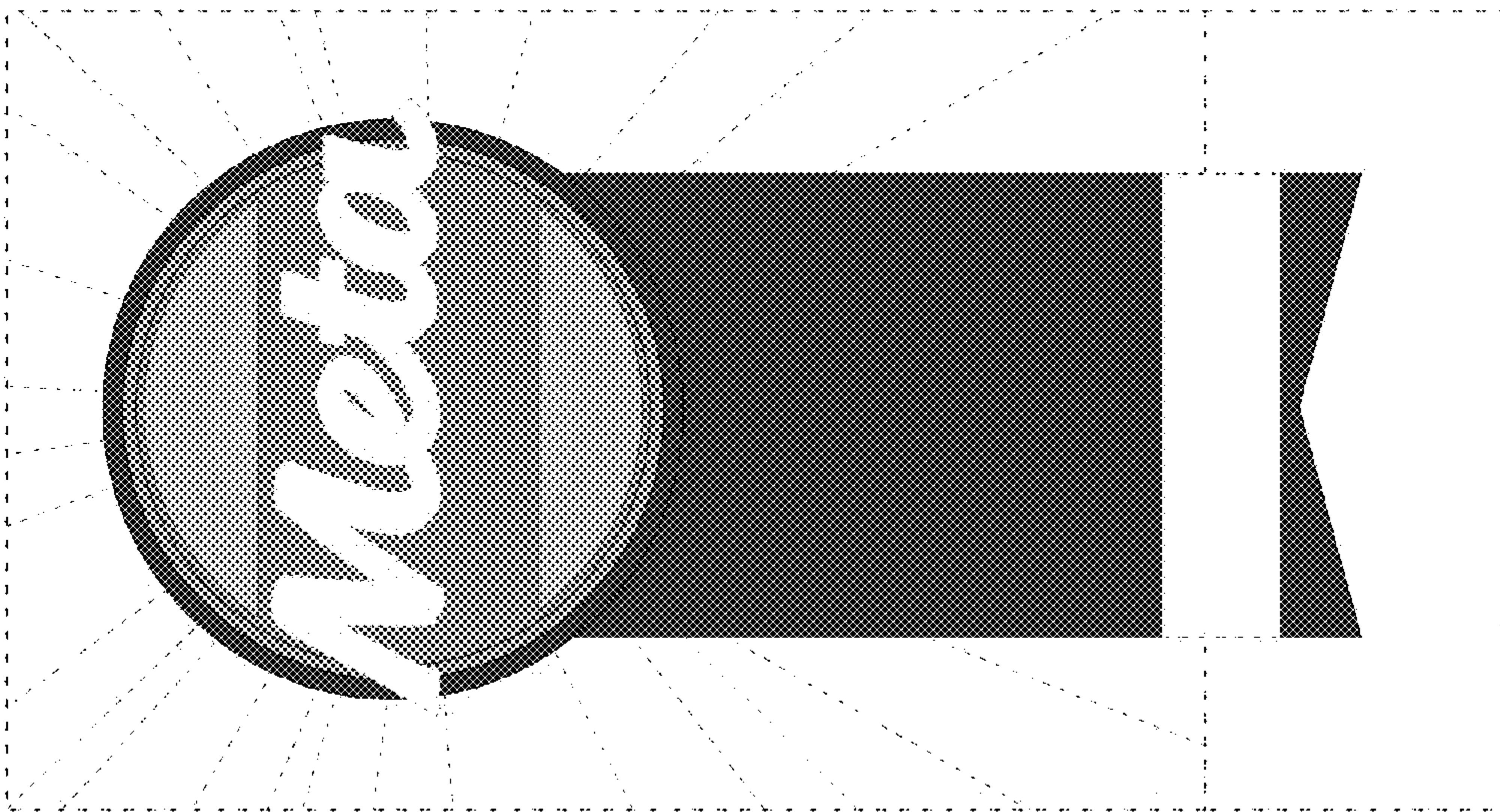

Fig. 23



Fig. 24

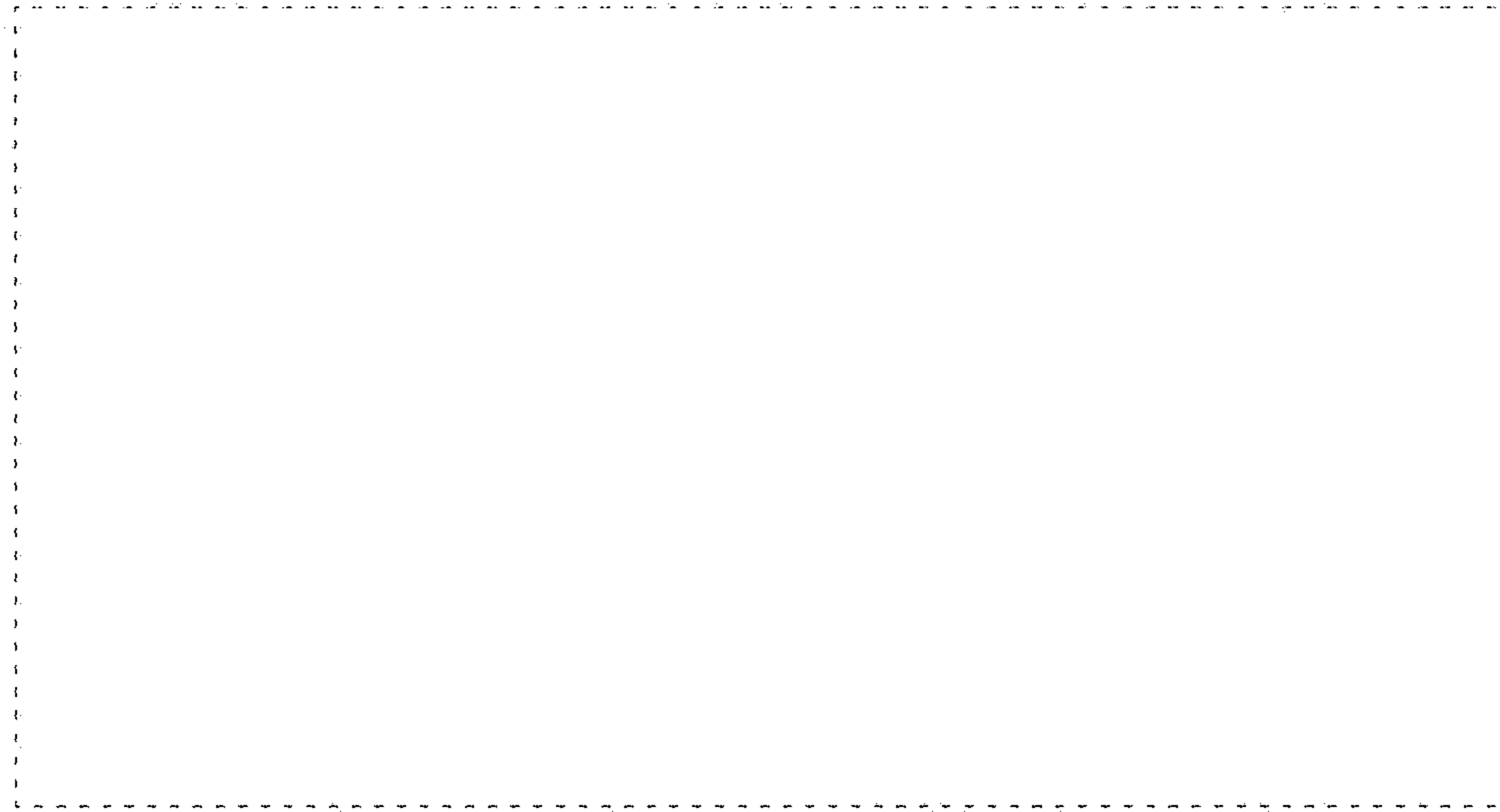

Fig. 25



Fig. 26

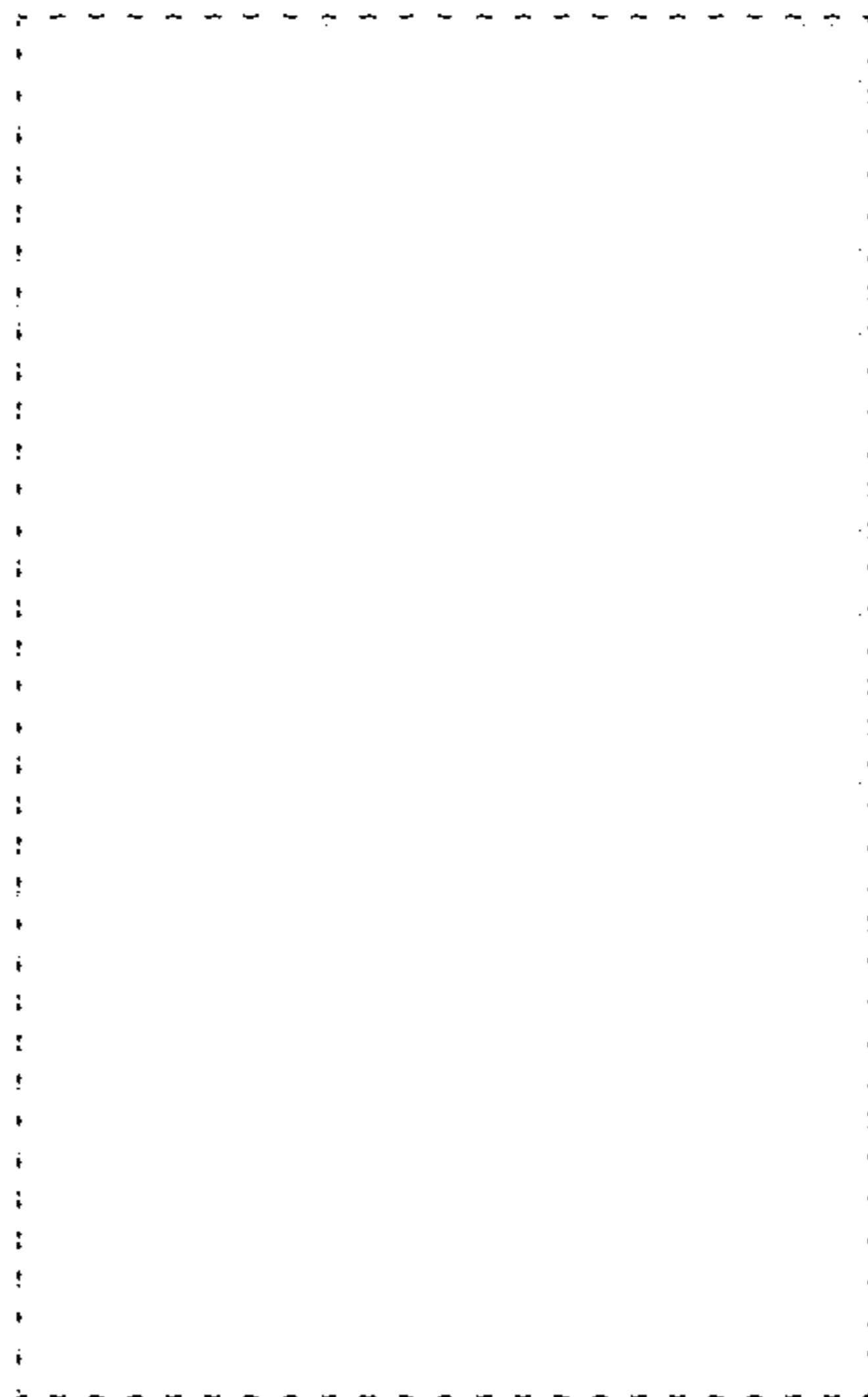

Fig. 27

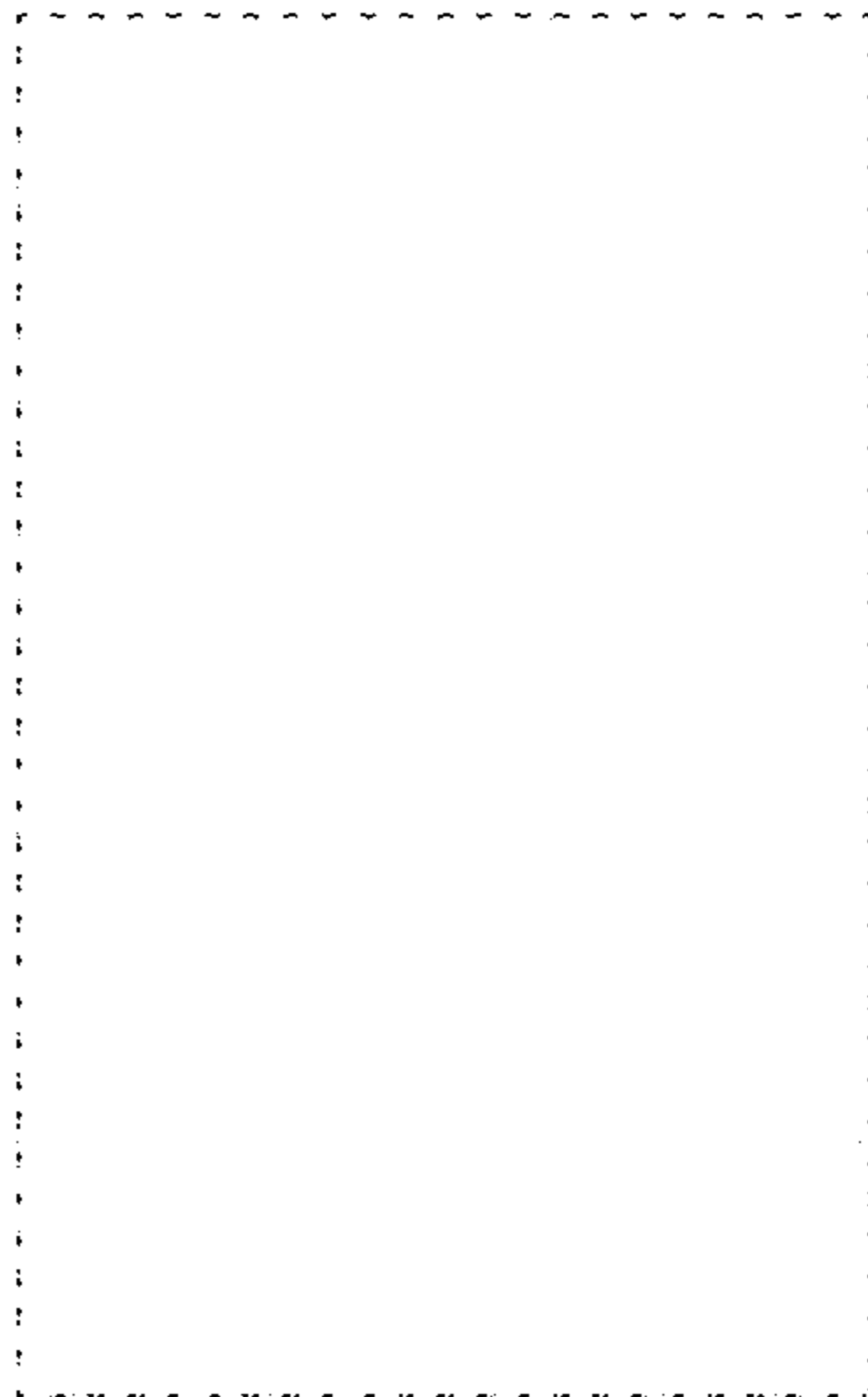

Fig. 28

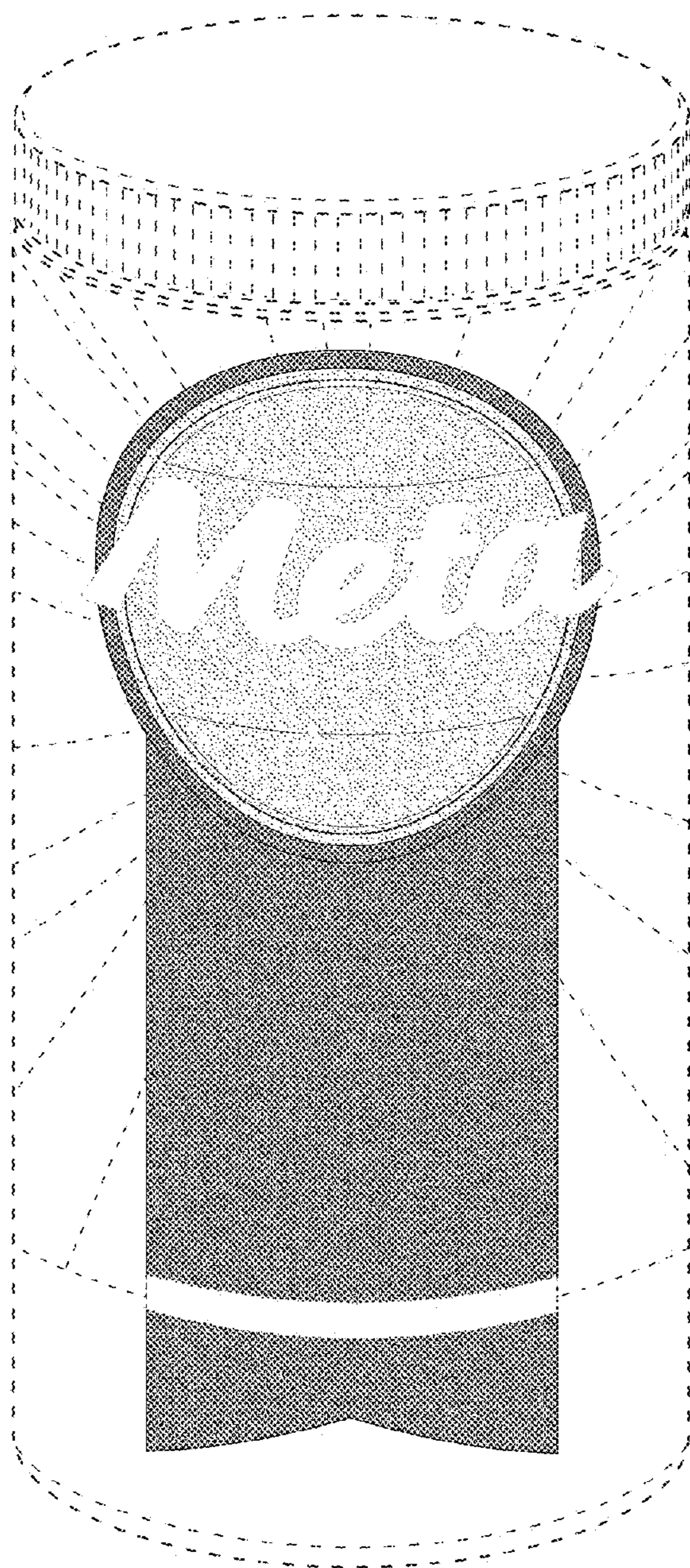

Fig. 29

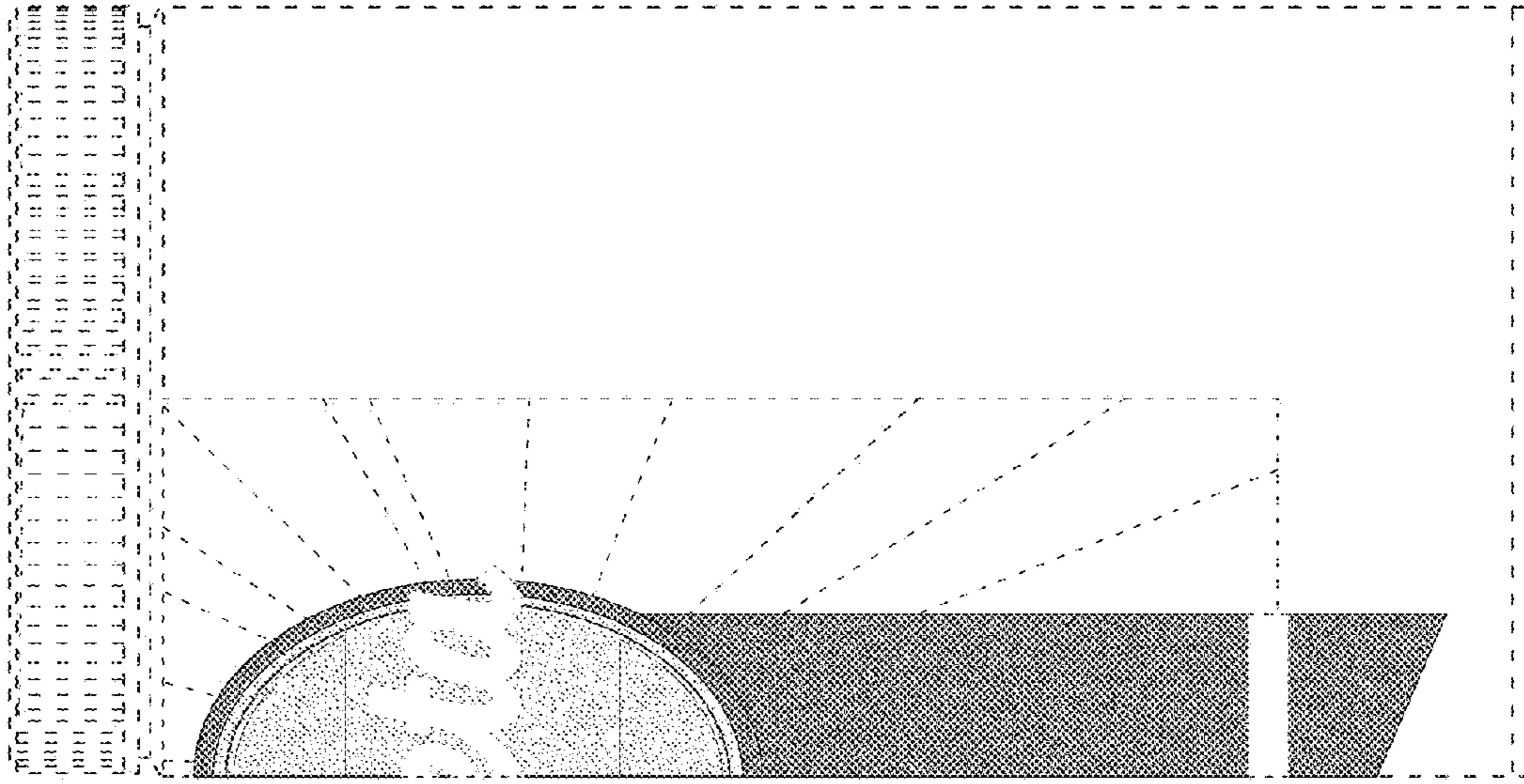

Fig. 30

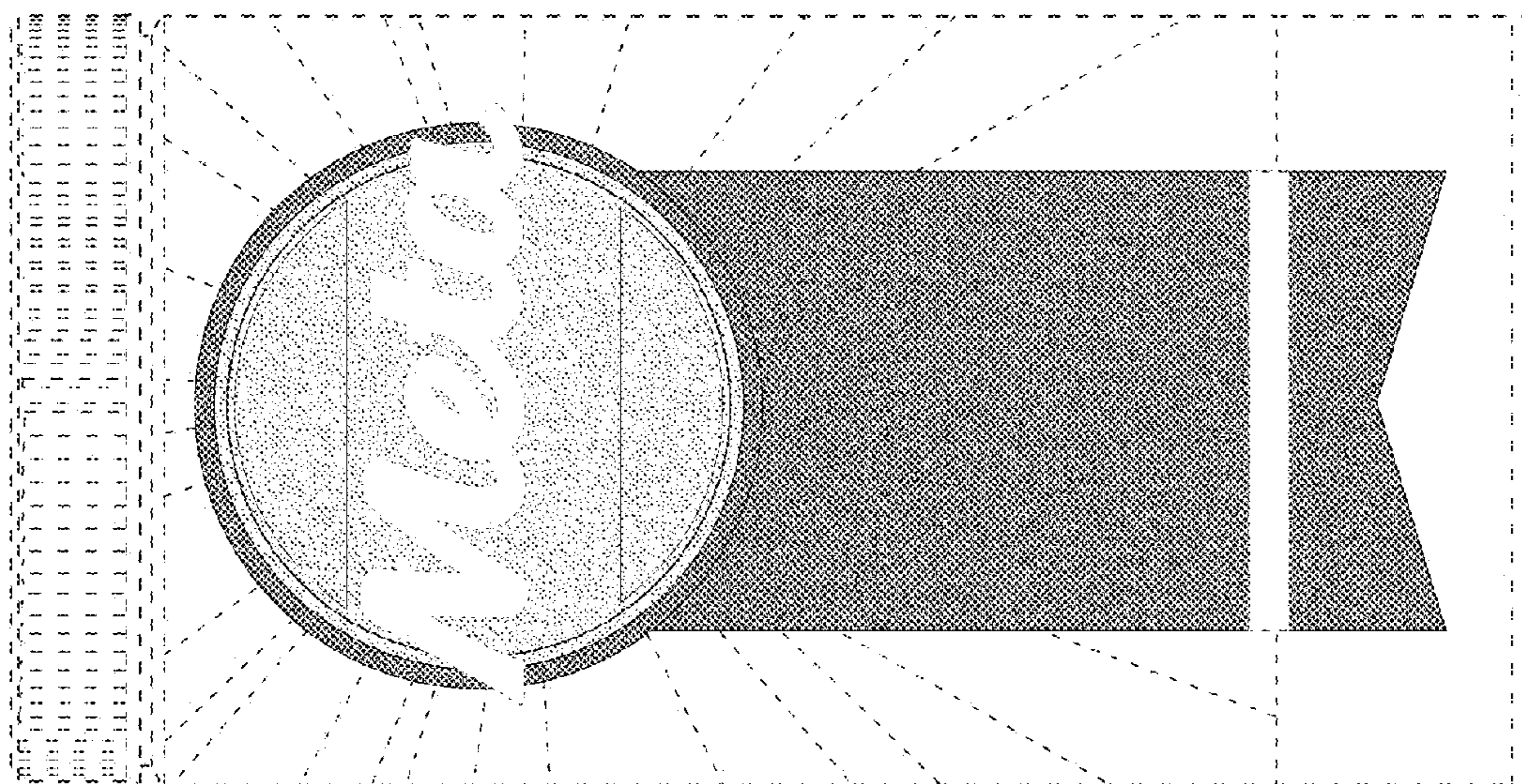

Fig. 31



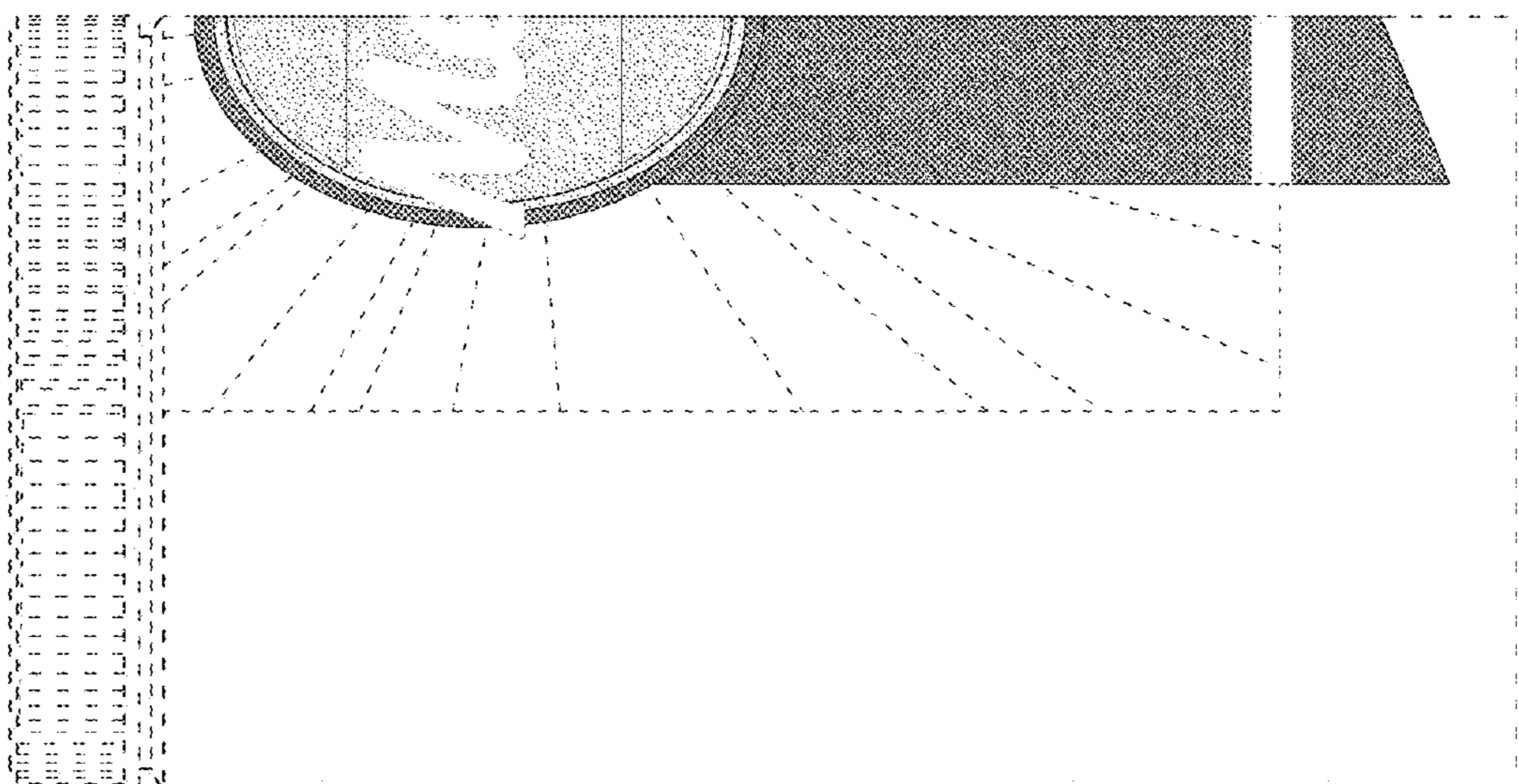

Fig. 32



Fig. 33

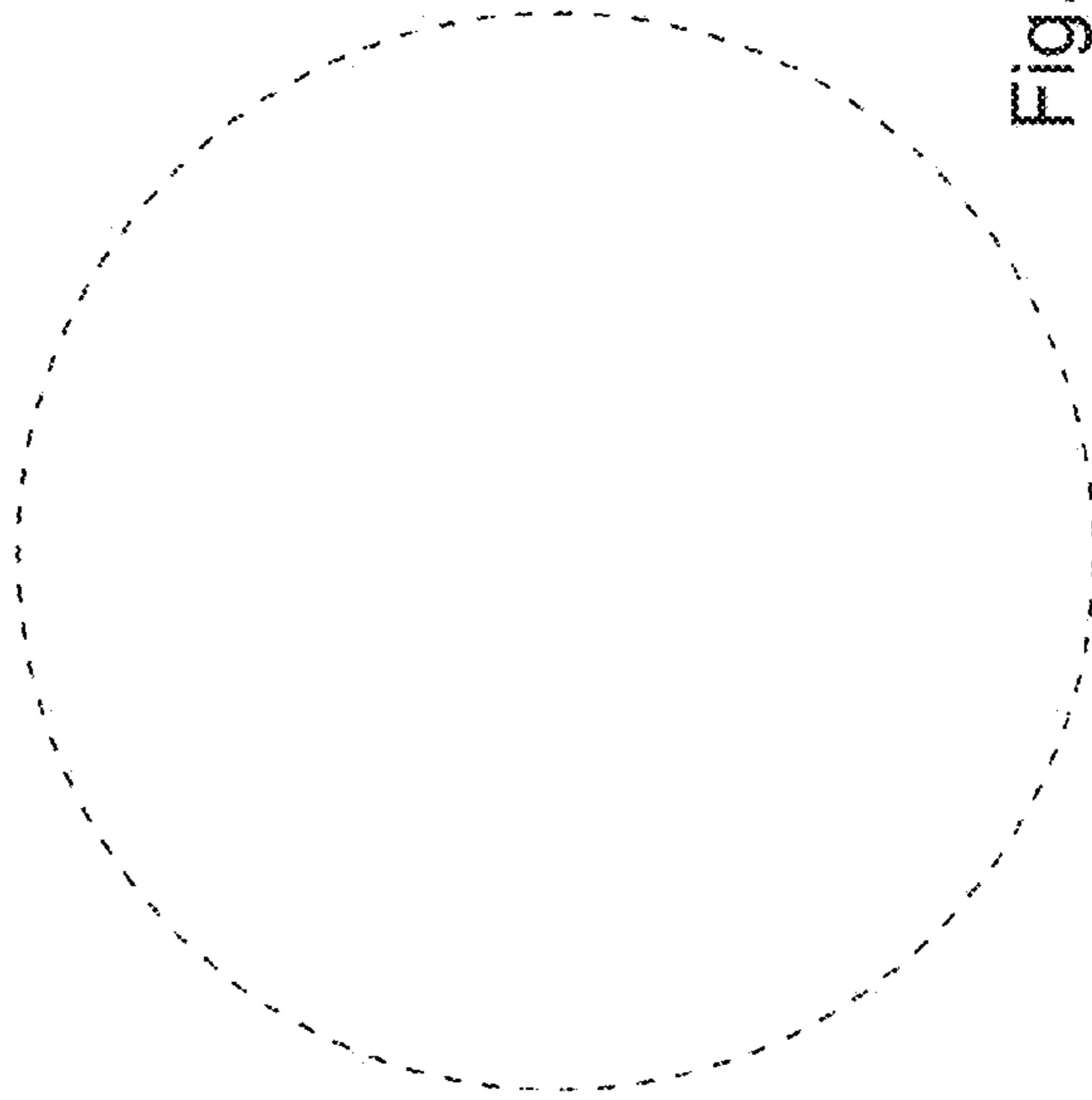

Fig. 35

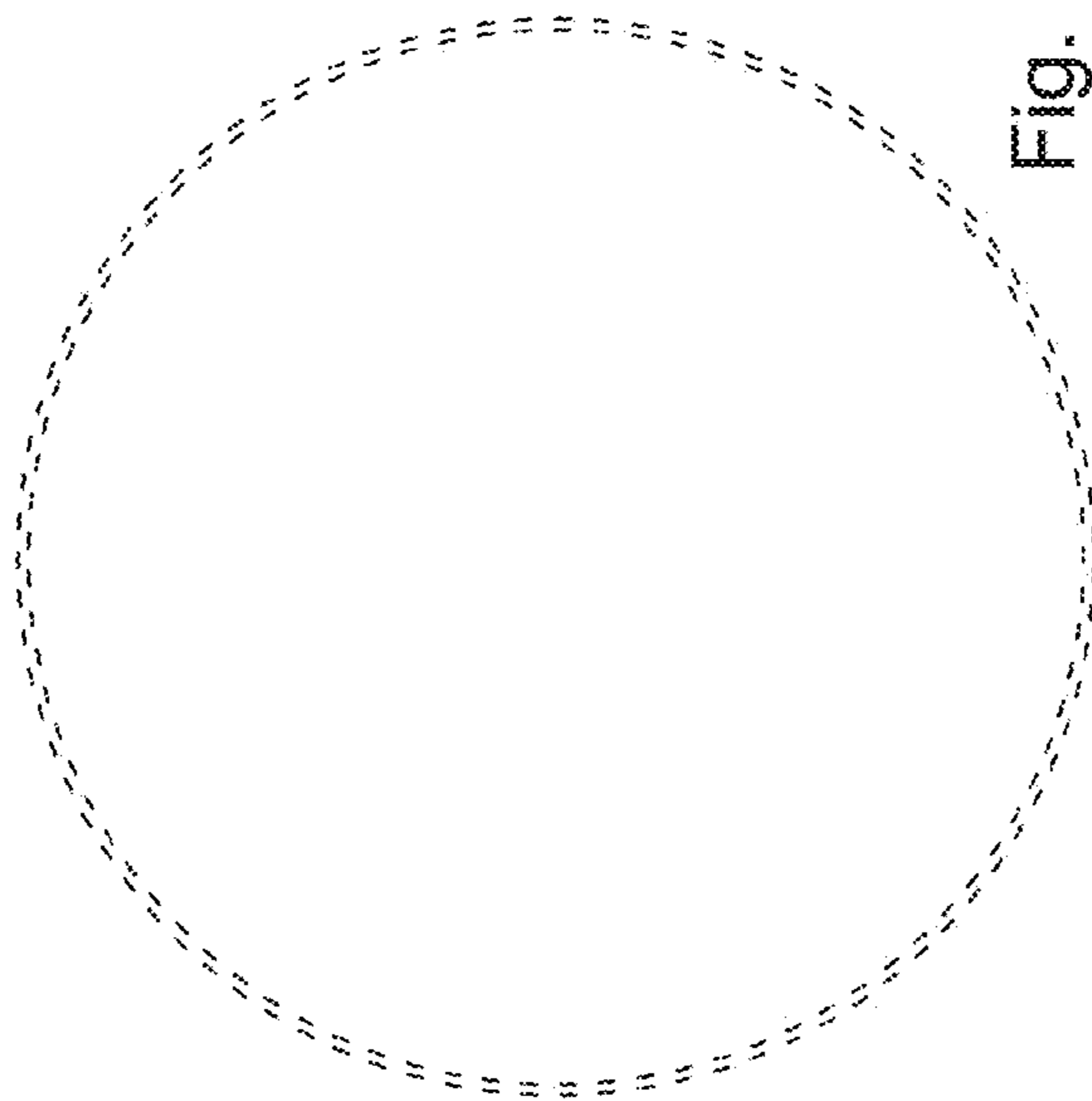

Fig. 34

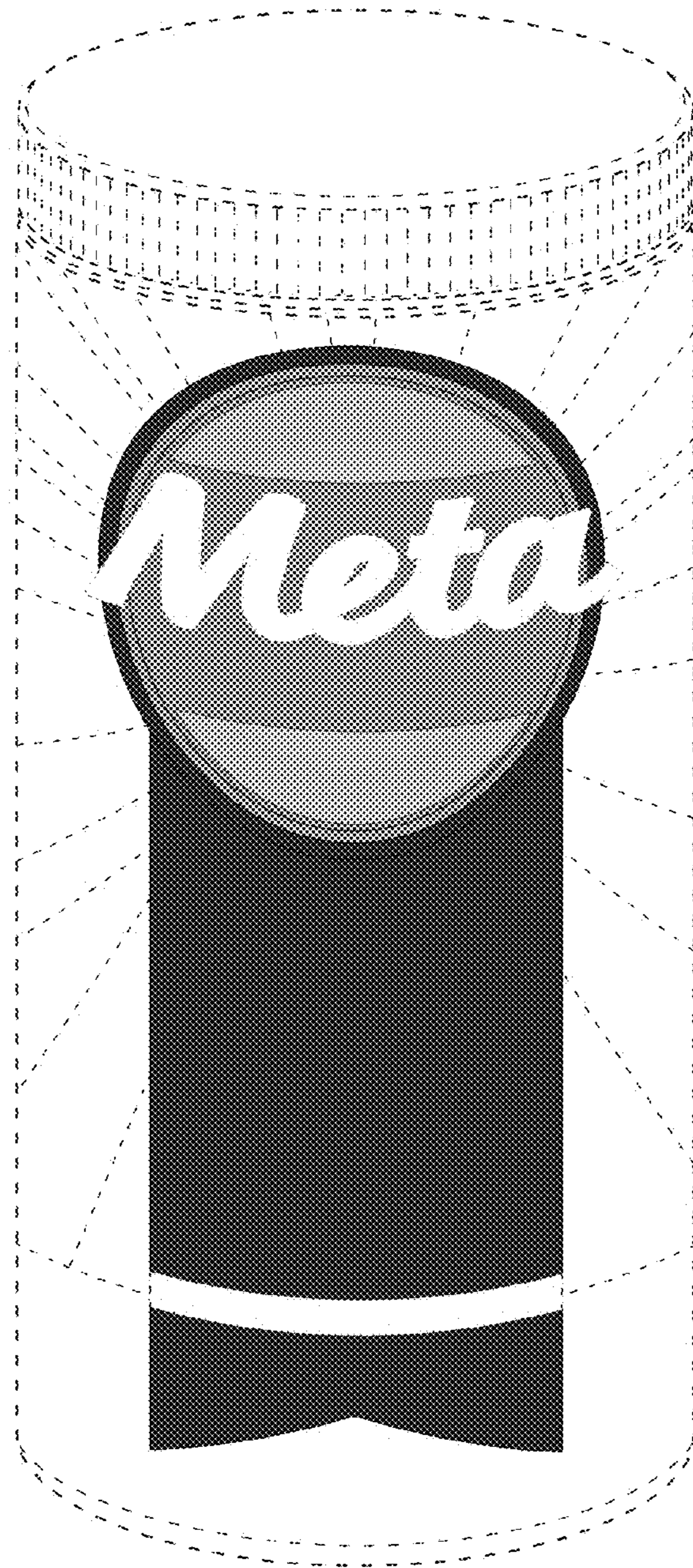

Fig. 36

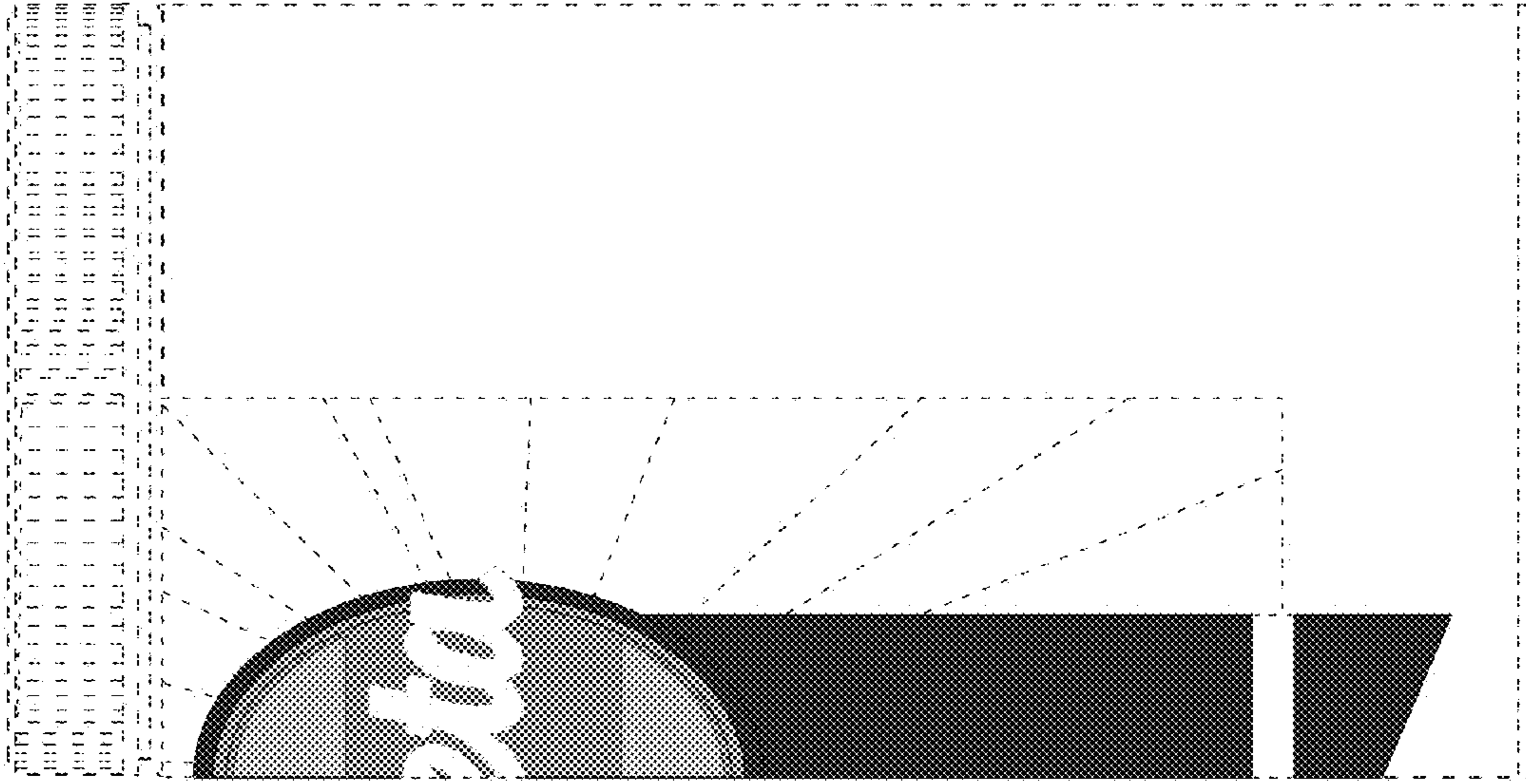

Fig. 38

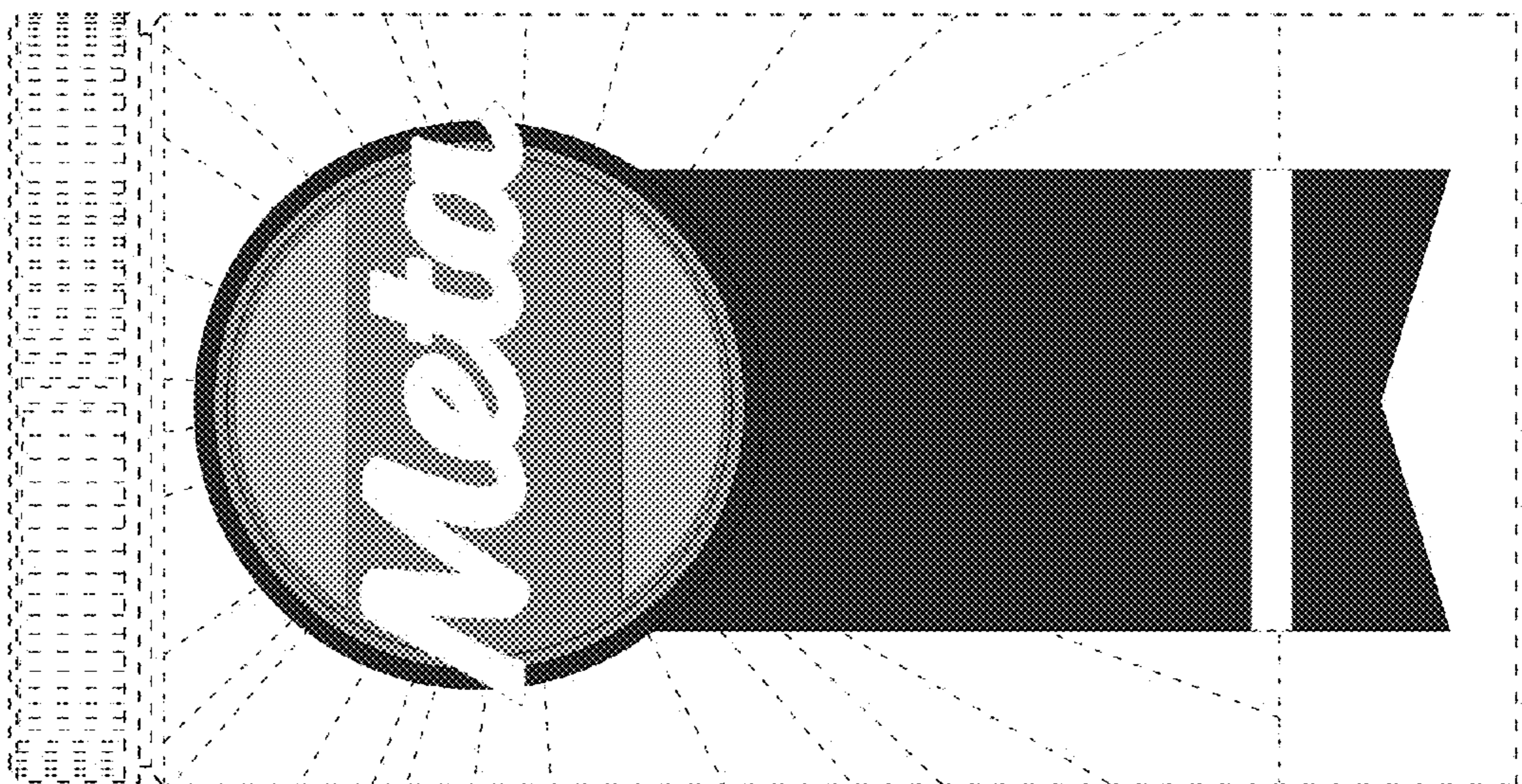

Fig. 37

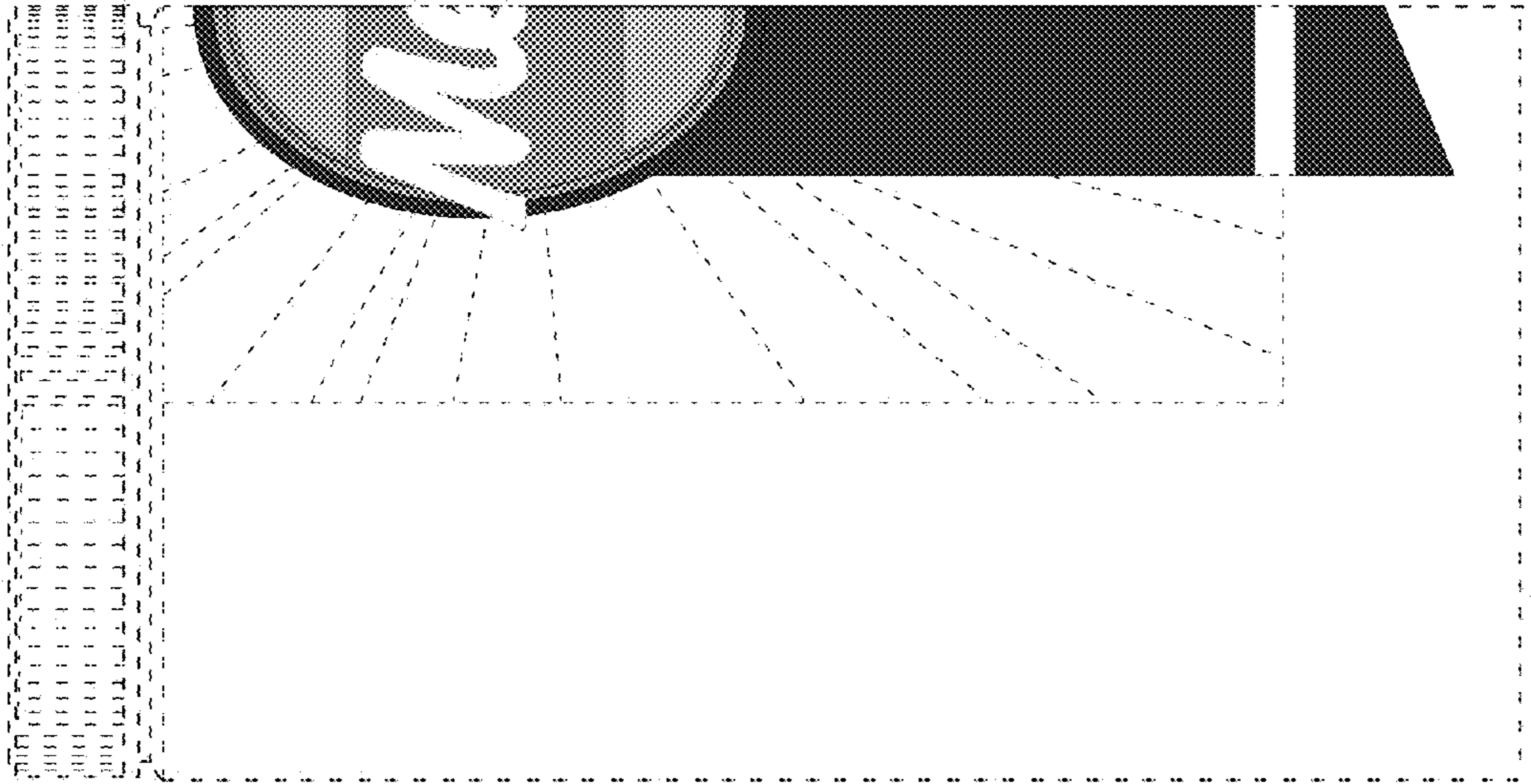

Fig. 39

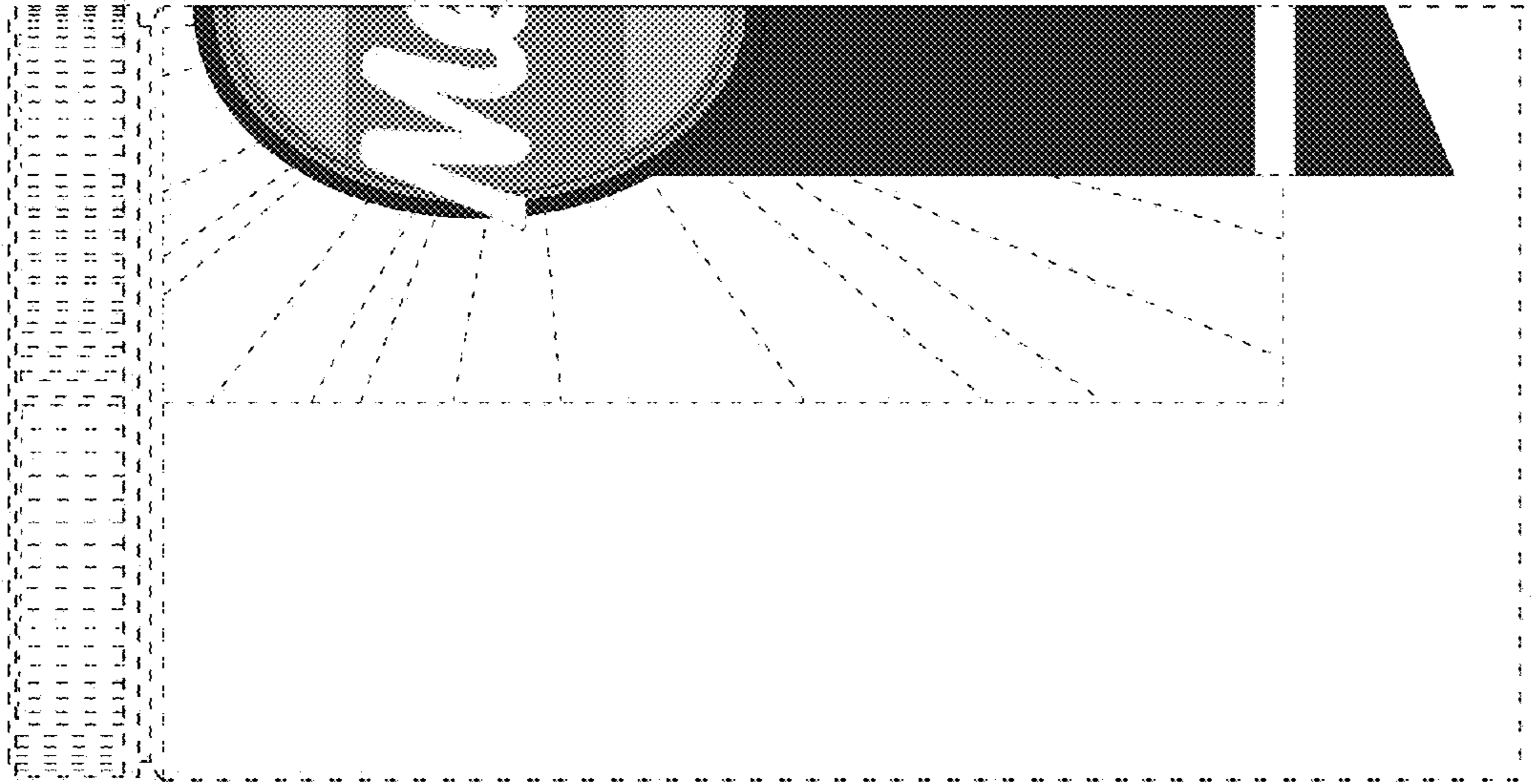

Fig. 40

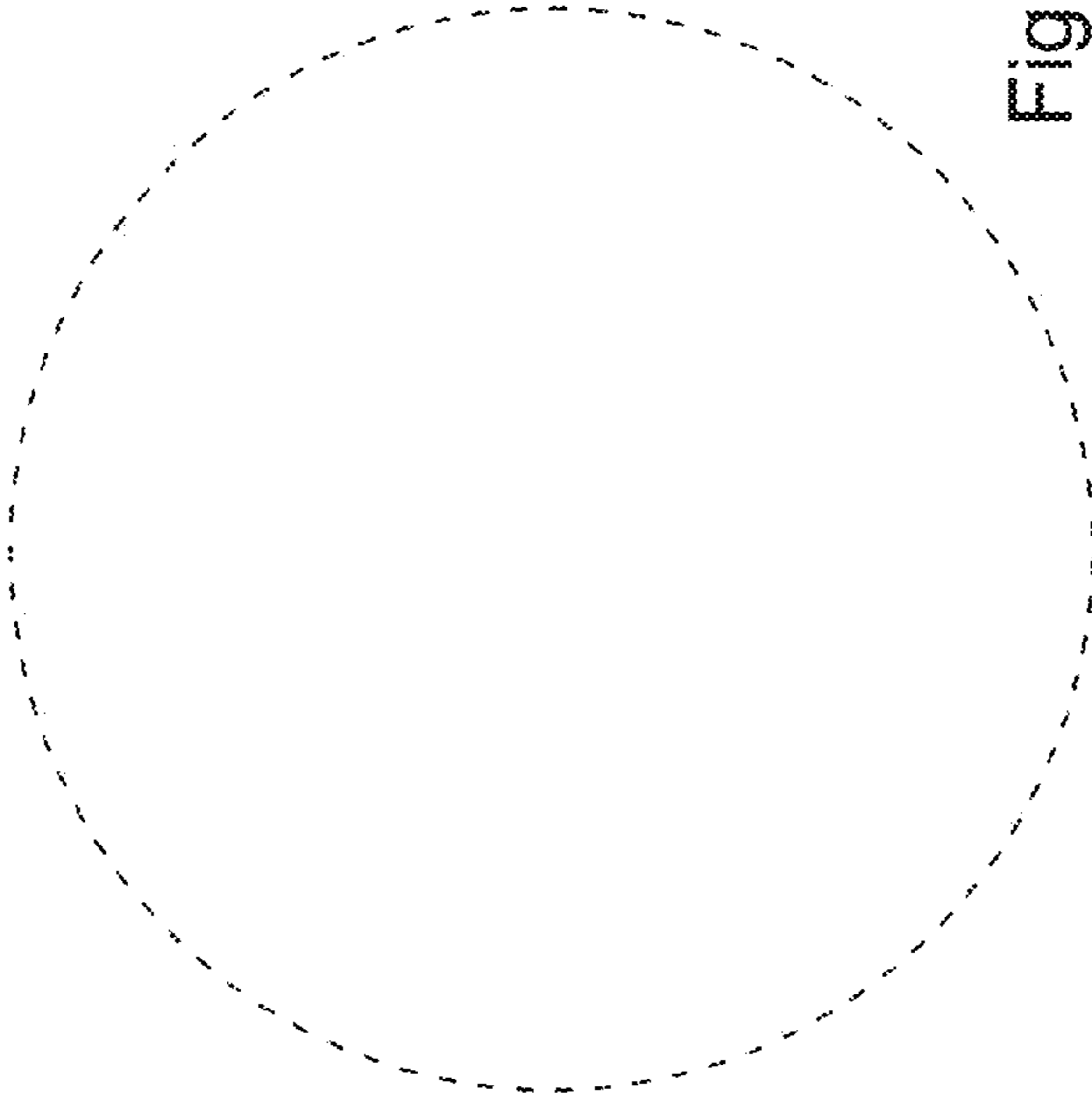

Fig. 42

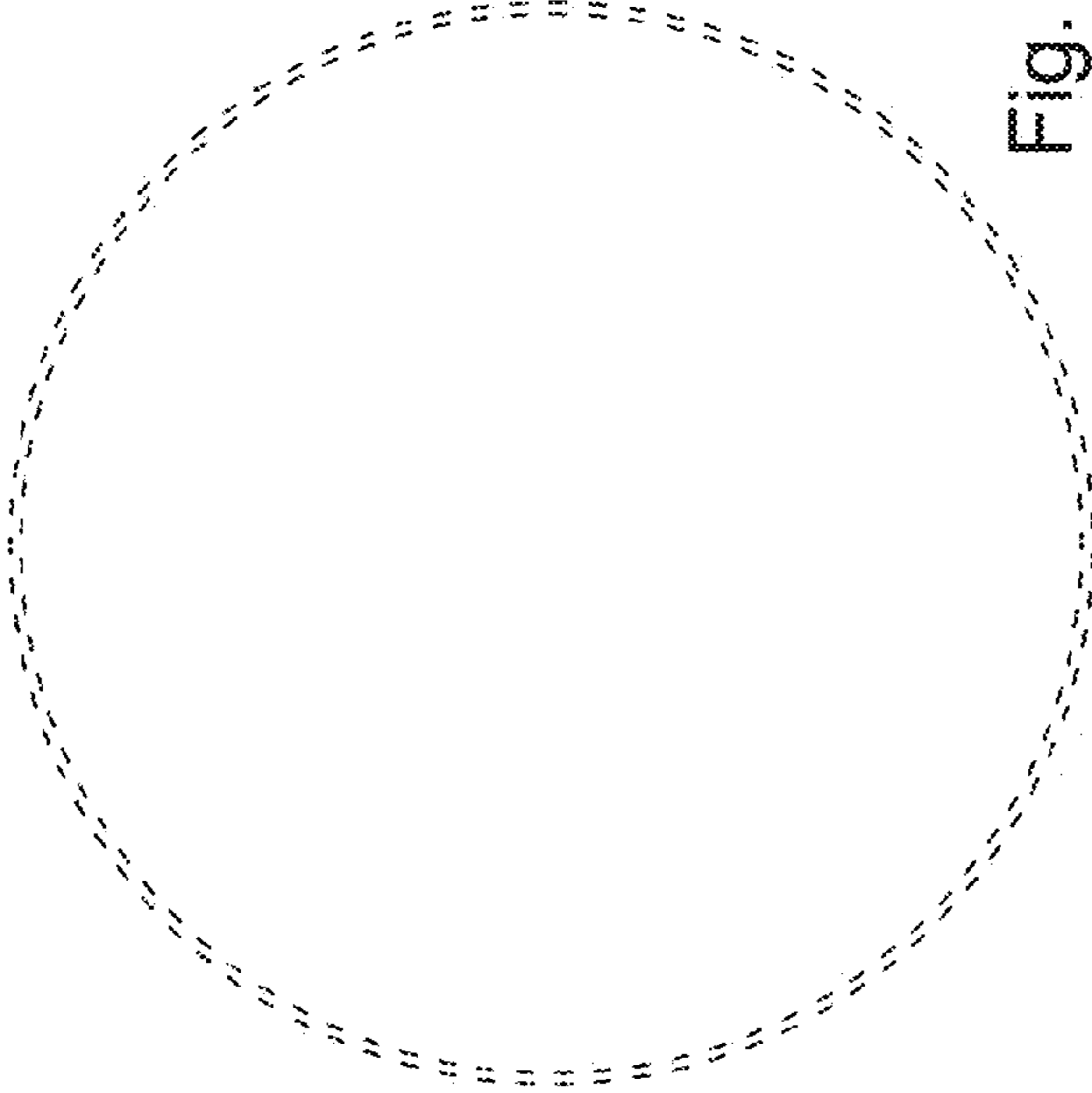

Fig. 41