



US00D750463S

(12) **United States Design Patent**  
**Sonne**

(10) **Patent No.:** **US D750,463 S**  
(45) **Date of Patent:** **\*\* Mar. 1, 2016**

(54) **HANDLE FOR APPLICATOR**

(71) Applicant: **Lawrence Julius Sonne**, Okemos, MI  
(US)

(72) Inventor: **Lawrence Julius Sonne**, Okemos, MI  
(US)

(\*\*) Term: **14 Years**

(21) Appl. No.: **29/474,771**

(22) Filed: **Feb. 4, 2015**

(51) **LOC (10) Cl.** ..... **08-05**

(52) **U.S. Cl.**  
USPC ..... **D8/107; D8/14**

(58) **Field of Classification Search**  
USPC ..... D8/14, 45, 107; D32/46, 48  
CPC ..... A47L 13/08; B26B 5/00; B44D 3/162;  
B44D 3/164

See application file for complete search history.

(56) **References Cited**

**U.S. PATENT DOCUMENTS**

1,458,171	A	6/1923	Donaldson	
1,704,376	A	3/1929	Teasdale	
2,043,775	A	6/1936	Rosen	
2,133,087	A *	10/1938	Ericsson	B44D 3/162 15/236.01
2,257,314	A *	9/1941	Shinn, Jr.	A47L 13/08 15/236.01
2,359,408	A *	10/1944	Disse	B23D 79/00 15/236.01
4,350,445	A	9/1982	Olsson	
4,481,689	A *	11/1984	Westmoreland	B44D 3/164 15/236.01
D300,600	S *	4/1989	High	D8/107
4,821,418	A *	4/1989	Windhager	A47L 13/08 30/329
D307,855	S	5/1990	Light, Jr.	
5,010,647	A *	4/1991	Gray	B44D 3/164 15/236.01
5,048,184	A *	9/1991	Saxton	B26B 5/006 30/169
5,208,984	A *	5/1993	Negus	A47L 13/08 15/236.01
D338,822	S *	8/1993	Mallalieu	D8/107

D363,861	S	11/1995	Slater	
D379,293	S *	5/1997	Schultz	D8/98
D391,821	S *	3/1998	Schultz	D8/98
6,000,137	A *	12/1999	Gamba	B26B 1/08 15/236.01
D418,723	S	1/2000	Bowman	
D436,810	S	1/2001	Slater	
D508,838	S *	8/2005	Meizlish	D8/98
6,966,100	B2	11/2005	Sonne	
D549,463	S	8/2007	Potempa	
7,506,399	B2	3/2009	Fortune	
D614,470	S *	4/2010	Parshad	D8/102
D682,498	S	5/2013	Sonne	

\* cited by examiner

*Primary Examiner* — Phillip S Hyder

(57) **CLAIM**

The ornamental design for a handle for applicator, as shown and described.

**DESCRIPTION**

FIG. 1 is a perspective view showing my new design;  
 FIG. 2 is a top plan view thereof;  
 FIG. 3 is a right side view thereof;  
 FIG. 4 is a bottom plan view thereof;  
 FIG. 5 is a side view thereof;  
 FIG. 6 is a front view thereof;  
 FIG. 7 is a rear view thereof;  
 FIG. 8 is a top plan thereof, in the environment of a bucket;  
 FIG. 9 is a second perspective view thereof, wherein the broken line showing of the applicator is in an alternate position;  
 FIG. 10 is a top plan view thereof;  
 FIG. 11 is a right side view with the left side view being a mirror image thereof;  
 FIG. 12 is a bottom plan view thereof;  
 FIG. 13 is a front view thereof;  
 FIG. 14 is a rear view thereof; and,  
 FIG. 15 is a top plan view thereof, in the environment of a bucket.

The broken line showing of the applicator in FIGS. 1 through 15 and the bucket in FIGS. 8 and 15 are provided for purposes of environment and form no part of the claimed design.

**1 Claim, 8 Drawing Sheets**

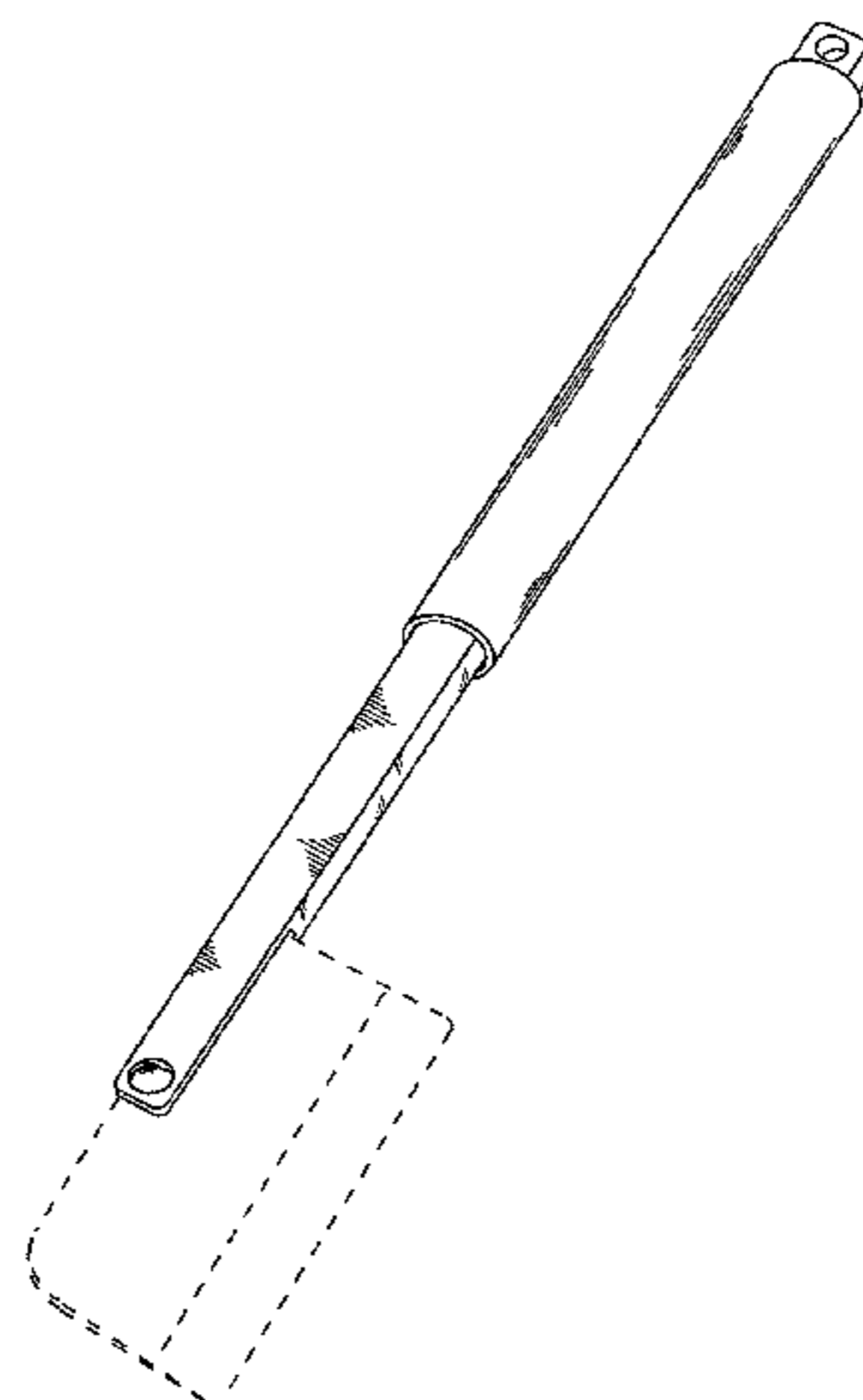

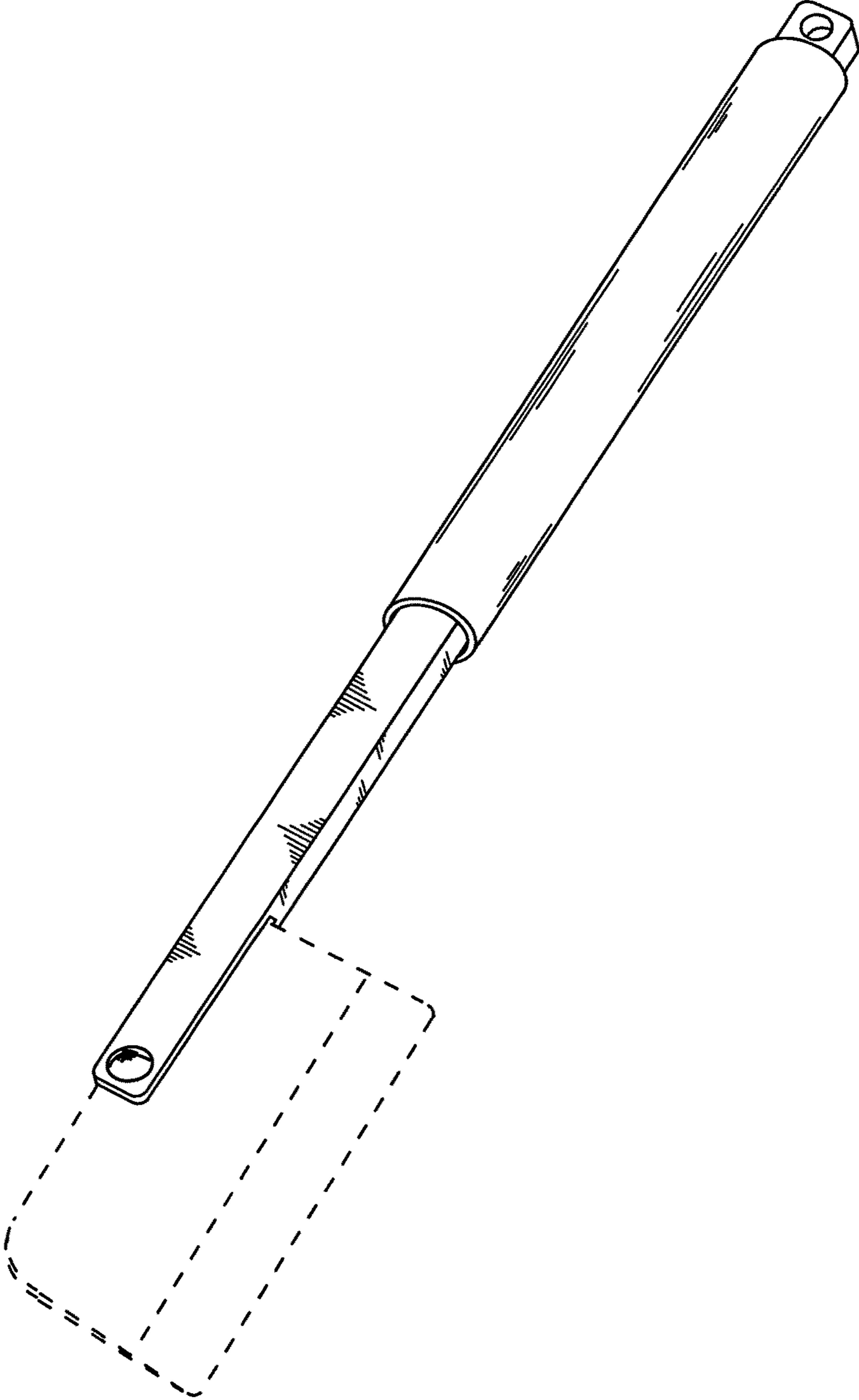

FIG. 1

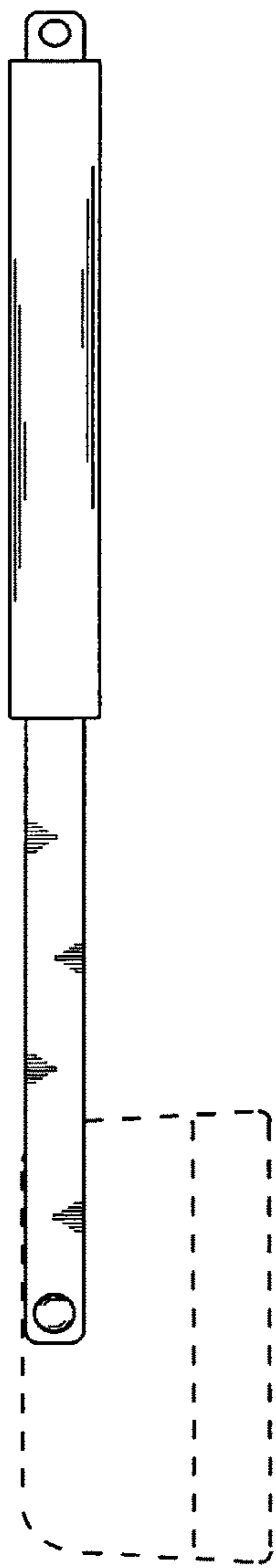

FIG. 2



FIG. 3

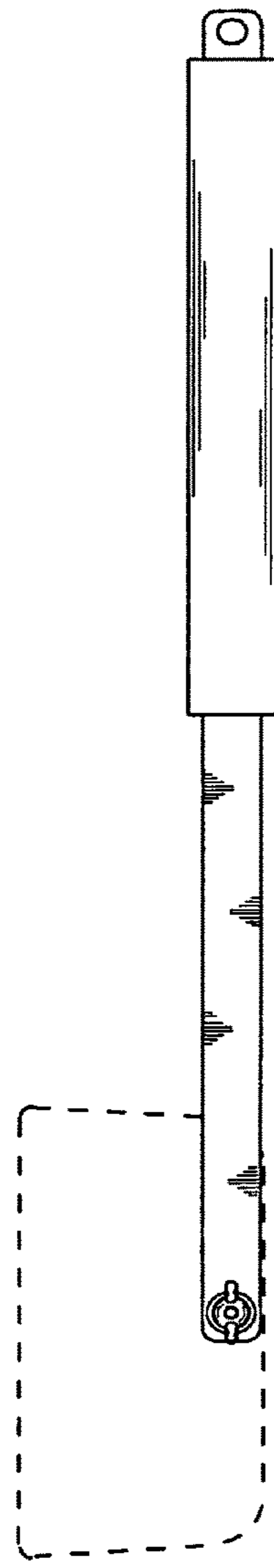

FIG. 4



FIG. 5

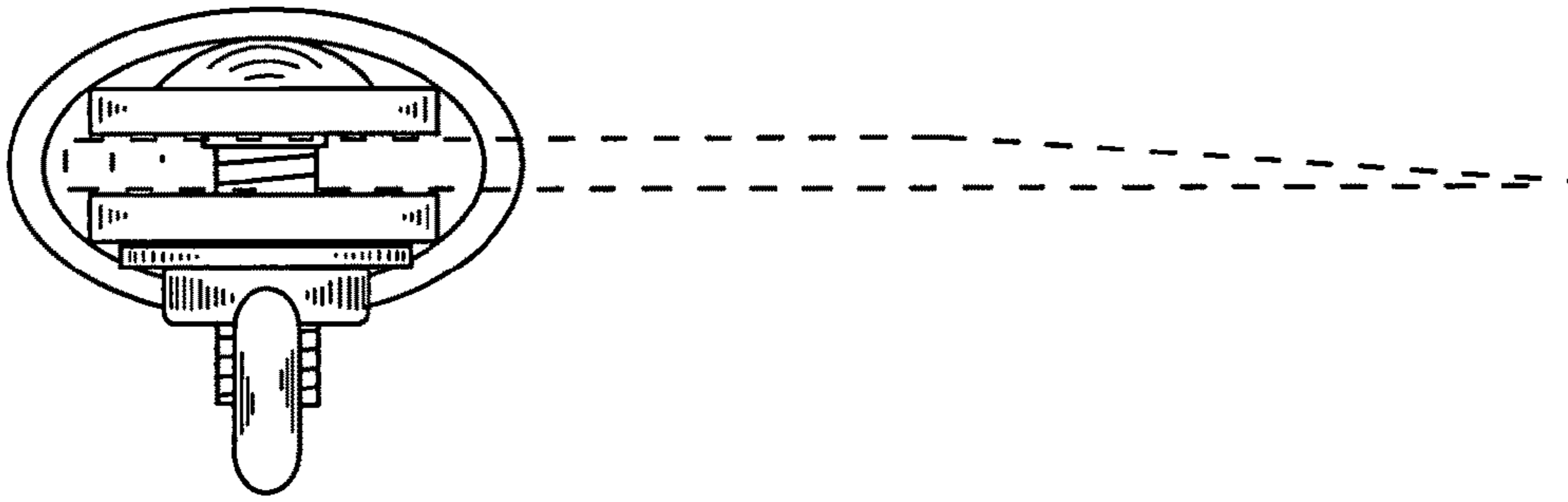

FIG. 6

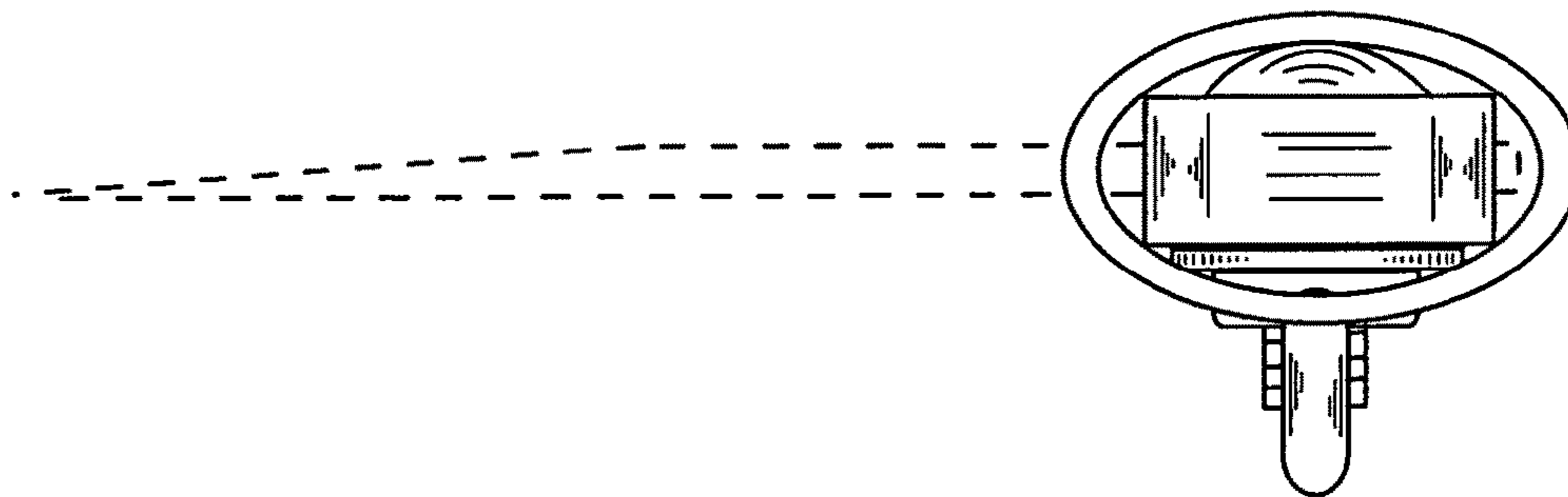

FIG. 7

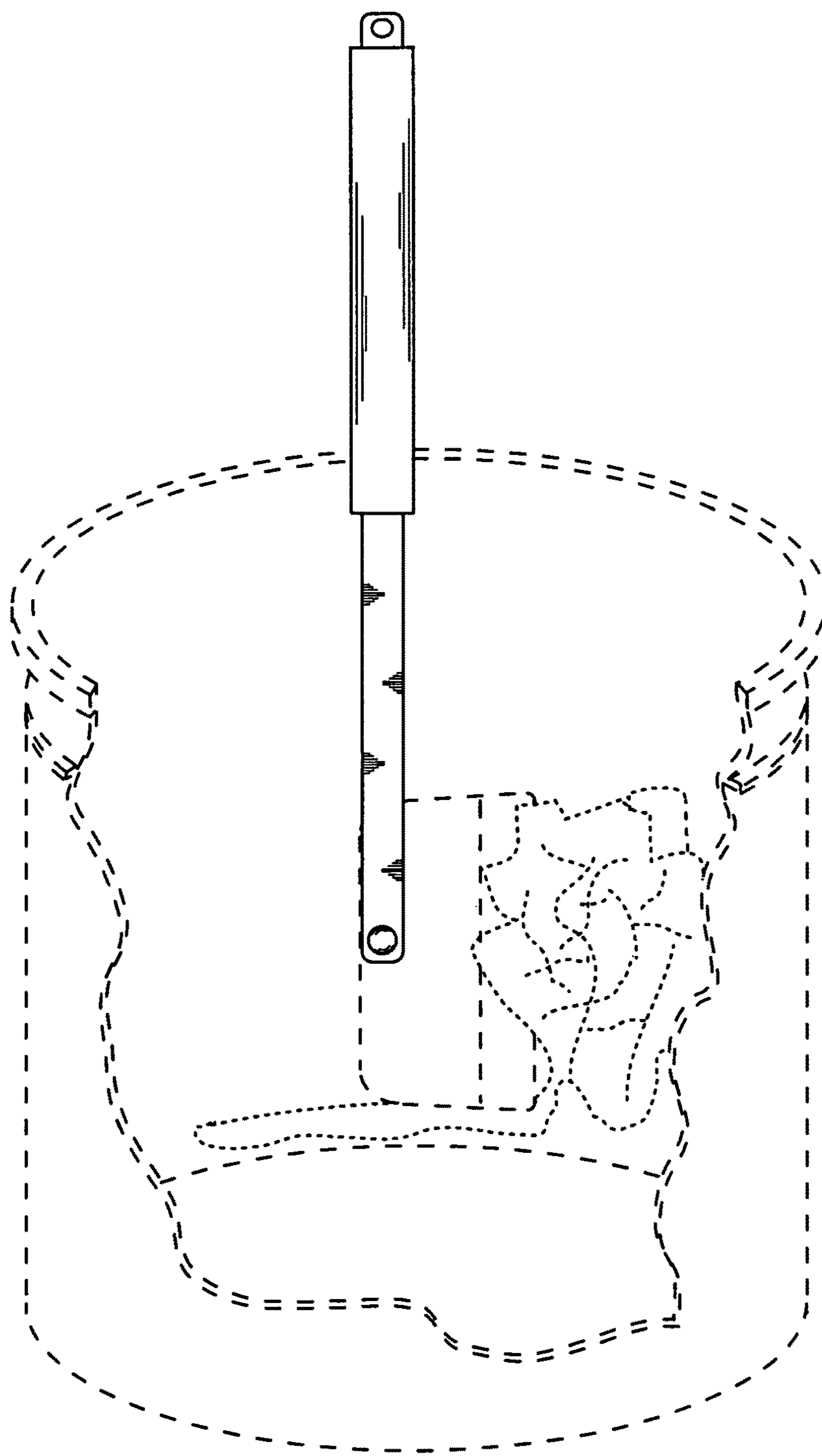

FIG. 8

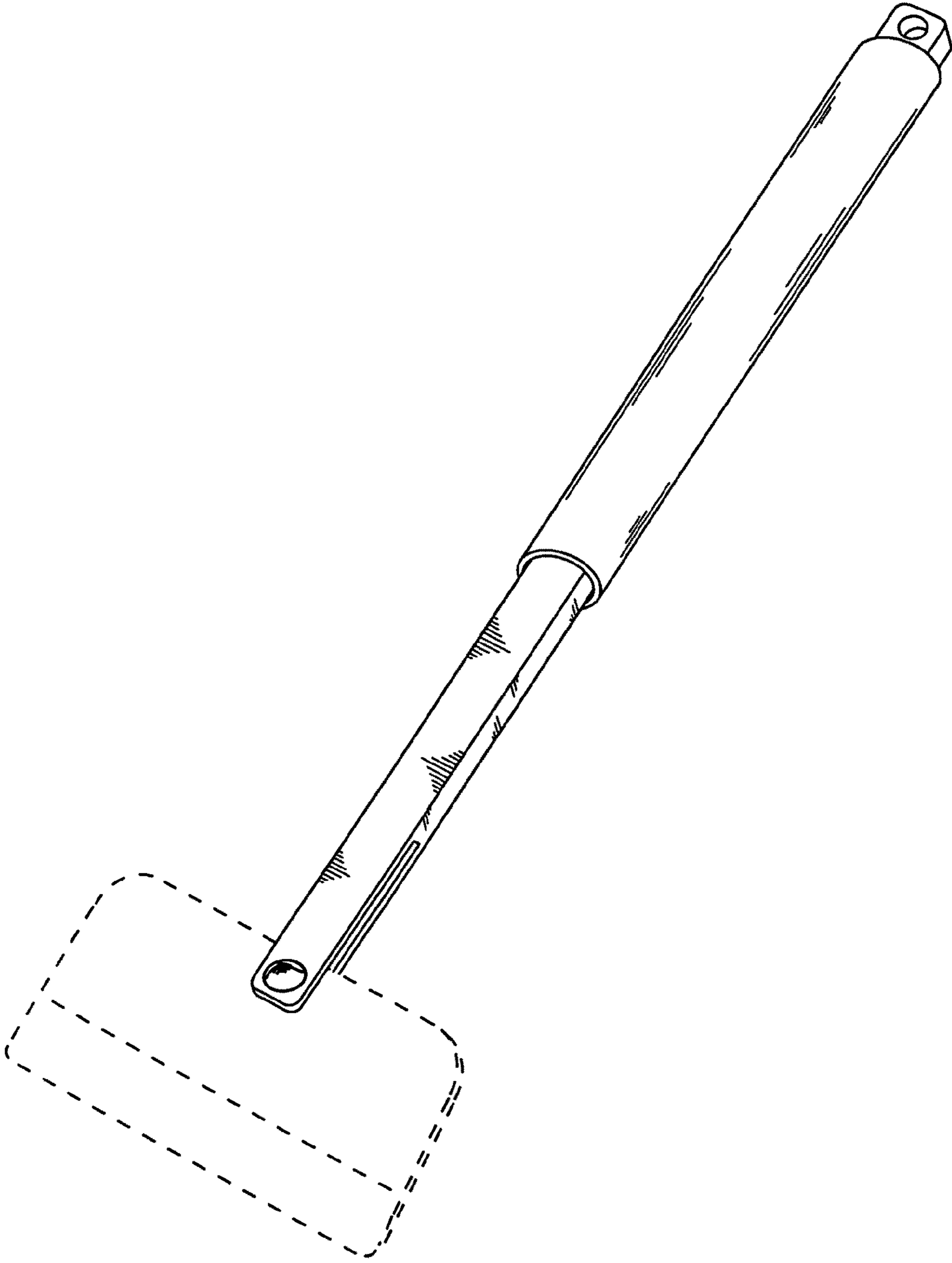

FIG. 9

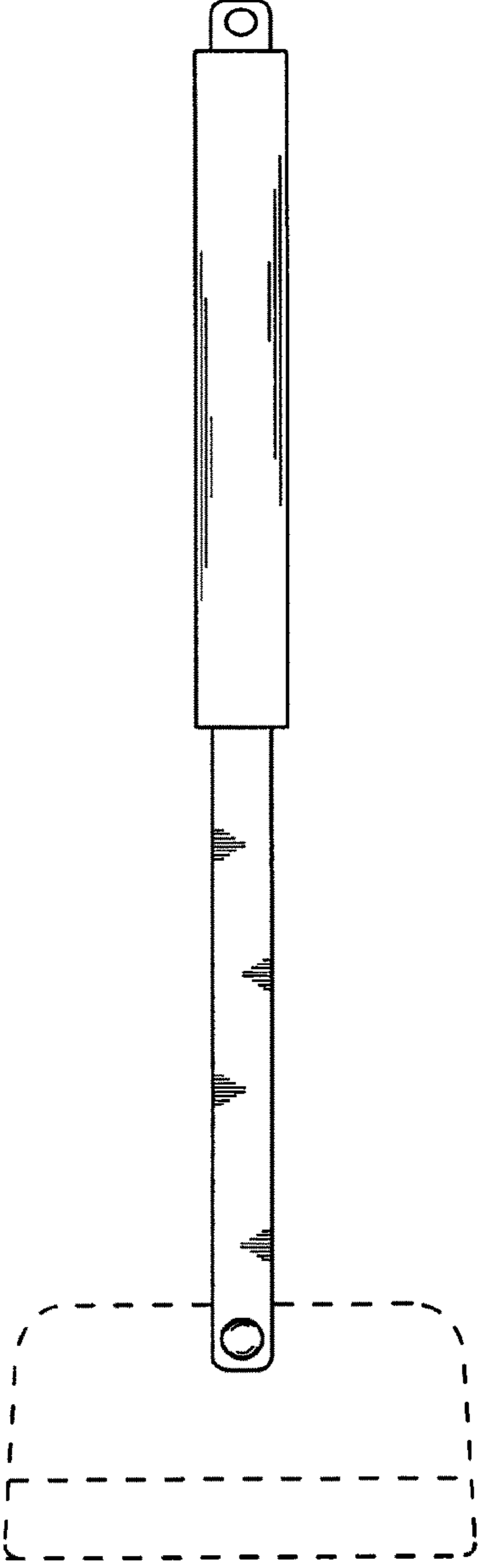

FIG. 10



FIG. 11

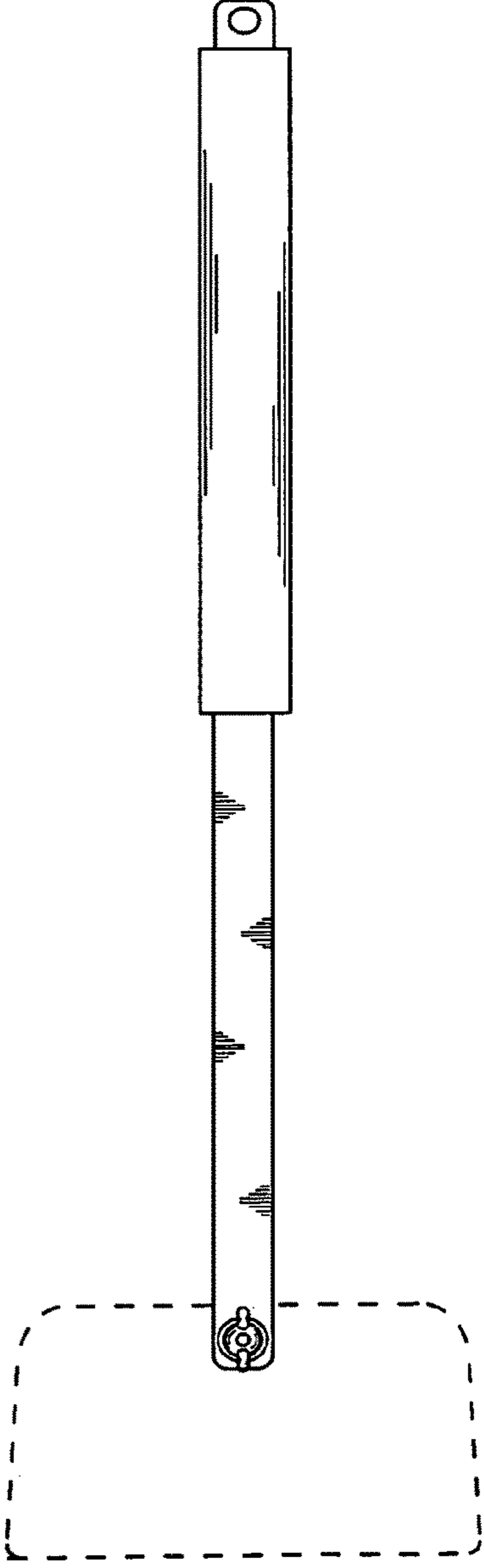

FIG. 12

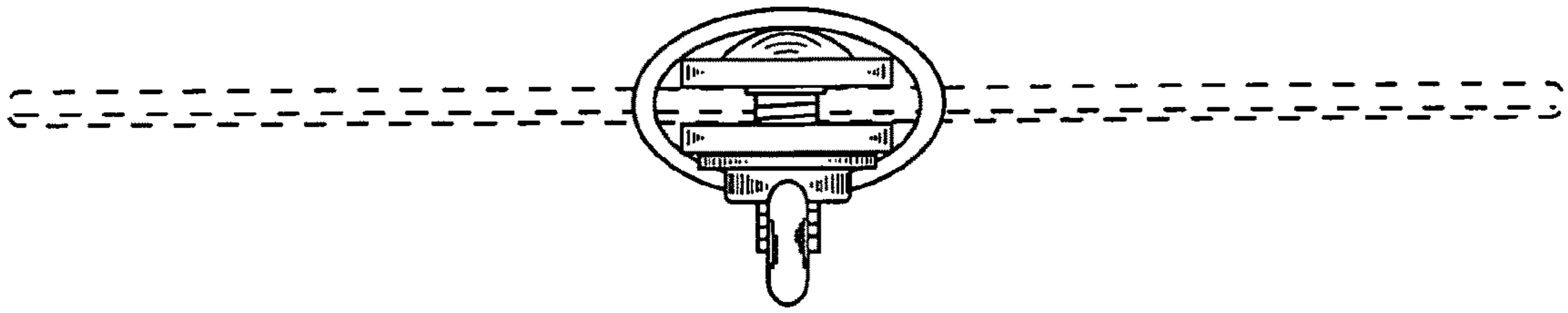

FIG. 13

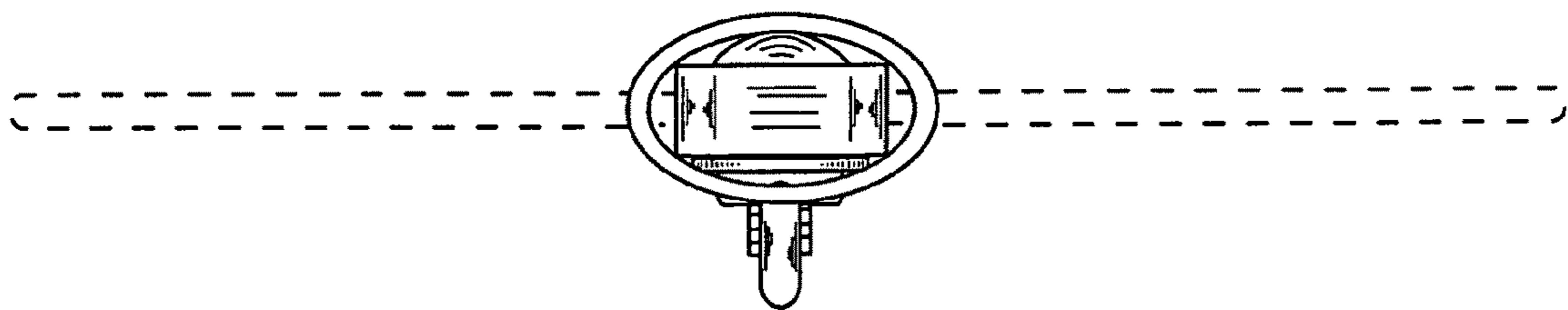

FIG. 14



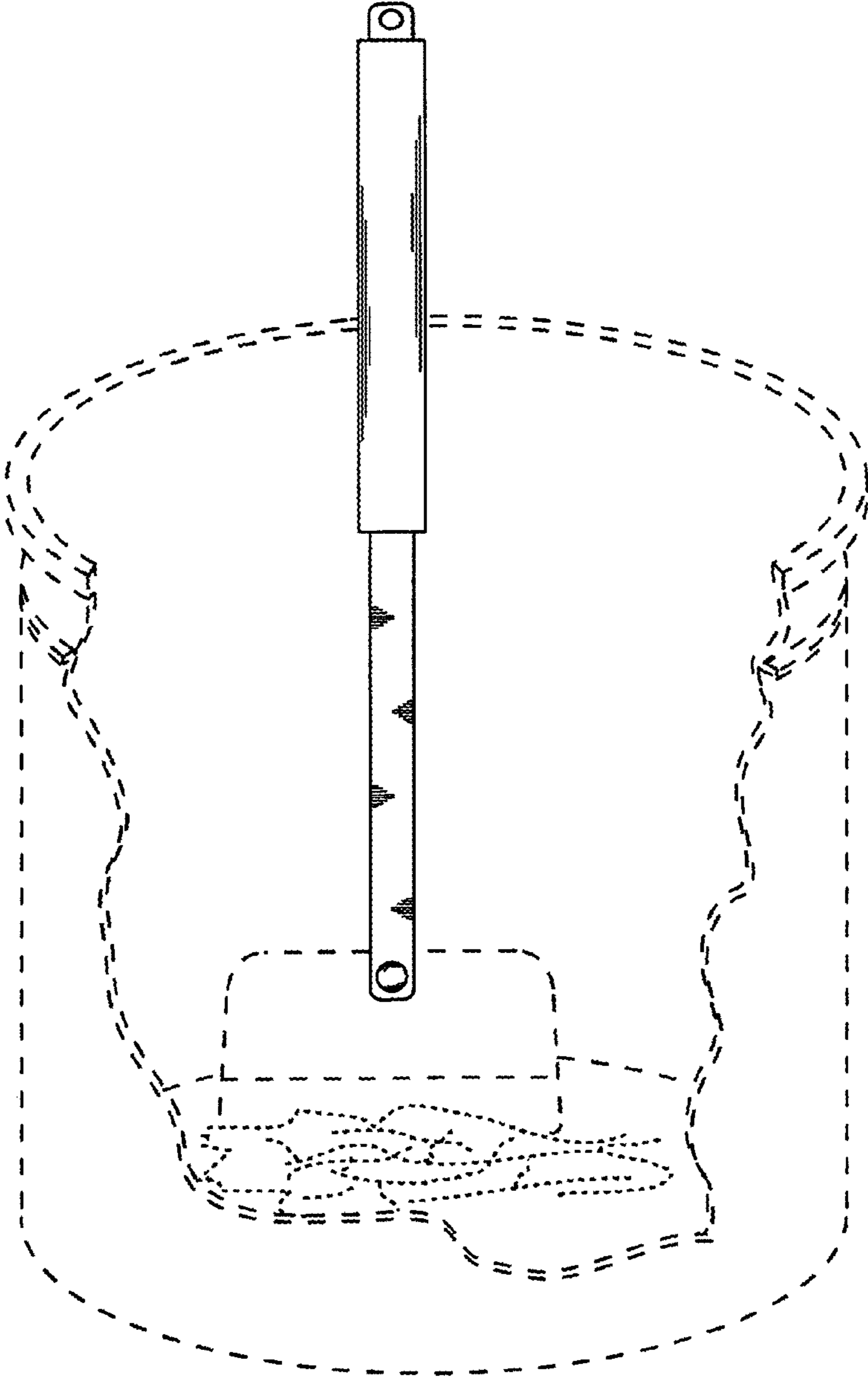

FIG. 15