



US00D750429S

(12) **United States Design Patent**
Lindsay et al.

(10) **Patent No.:** **US D750,429 S**
(45) **Date of Patent:** **** Mar. 1, 2016**

(54) **STRAINER FOR A BEVERAGE CONTAINER**

(71) Applicant: **SISTEMA PLASTICS LIMITED**,
Auckland (NZ)

(72) Inventors: **Brendan Jon Lindsay**, Auckland (NZ);
Saleh Ghyiath, Auckland (NZ)

(73) Assignee: **Sistema Plastics Limited**, Auckland
(NZ)

(**) Term: **14 Years**

(21) Appl. No.: **29/497,741**

(22) Filed: **Jul. 28, 2014**

(30) **Foreign Application Priority Data**

Jan. 29, 2014 (NZ) 418466

(51) **LOC (10) Cl.** **31-00**

(52) **U.S. Cl.**
USPC **D7/399; D7/400; D7/667**

(58) **Field of Classification Search**

USPC D7/400, 396.2, 523, 387, 391, 392,
D7/392.1, 393, 396.1, 396.3, 397, 398,
D7/399, 401, 401.1, 213, 700, 667, 601,
D7/602, 603, 671, 672, 675, 589;
D10/46.2; D9/434, 435, 436, 439, 440,
D9/444, 447; 220/709, 23.89, 229, 212.5;
D3/203.1, 203.2, 302; D23/209, 268,
D23/25; 215/397; 426/433
CPC ... B29C 33/50; B29C 33/0038; A47J 31/005;
A47J 31/06; A47J 31/00; A47J 31/10; A47J
31/02; A47J 31/14; A47J 31/0621; A47J
31/0615; A47G 19/2222; A47G 19/2272;
A47G 19/16; A47G 19/14; B65D 21/0233;
A23F 3/16; A23F 3/00; A23F 5/00

See application file for complete search history.

(56) **References Cited**

U.S. PATENT DOCUMENTS

D46,776 S * 12/1914 Merz D7/667
1,247,906 A * 11/1917 Tully B65D 85/808
426/84
1,636,727 A * 7/1927 Willner A47G 19/14
99/319

(Continued)

FOREIGN PATENT DOCUMENTS

CN 2796611 Y 7/2006
GB 103961 2/1917

(Continued)

Primary Examiner — Marianne Pandozzi

Assistant Examiner — Jae Liang

(74) *Attorney, Agent, or Firm* — Morrison & Foerster LLP

(57) **CLAIM**

The ornamental design for a strainer for a beverage container,
as shown and described.

DESCRIPTION

FIG. 1 is a top perspective view of a strainer for a beverage container in a close position showing our new design;
FIG. 2 is a bottom perspective view thereof;
FIG. 3 is a front view thereof;
FIG. 4 is a rear view thereof;
FIG. 5 is a right side view thereof;
FIG. 6 is a left side view thereof;
FIG. 7 is a top view thereof;
FIG. 8 is a bottom view thereof;
FIG. 9 is a top perspective view of the strainer for a beverage container in an open position;
FIG. 10 is a bottom perspective view thereof;
FIG. 11 is a front view thereof;
FIG. 12 is a rear view thereof;
FIG. 13 is a right side view thereof;
FIG. 14 is a left side view thereof;
FIG. 15 is a top view thereof; and,
FIG. 16 is a bottom view thereof.

1 Claim, 16 Drawing Sheets

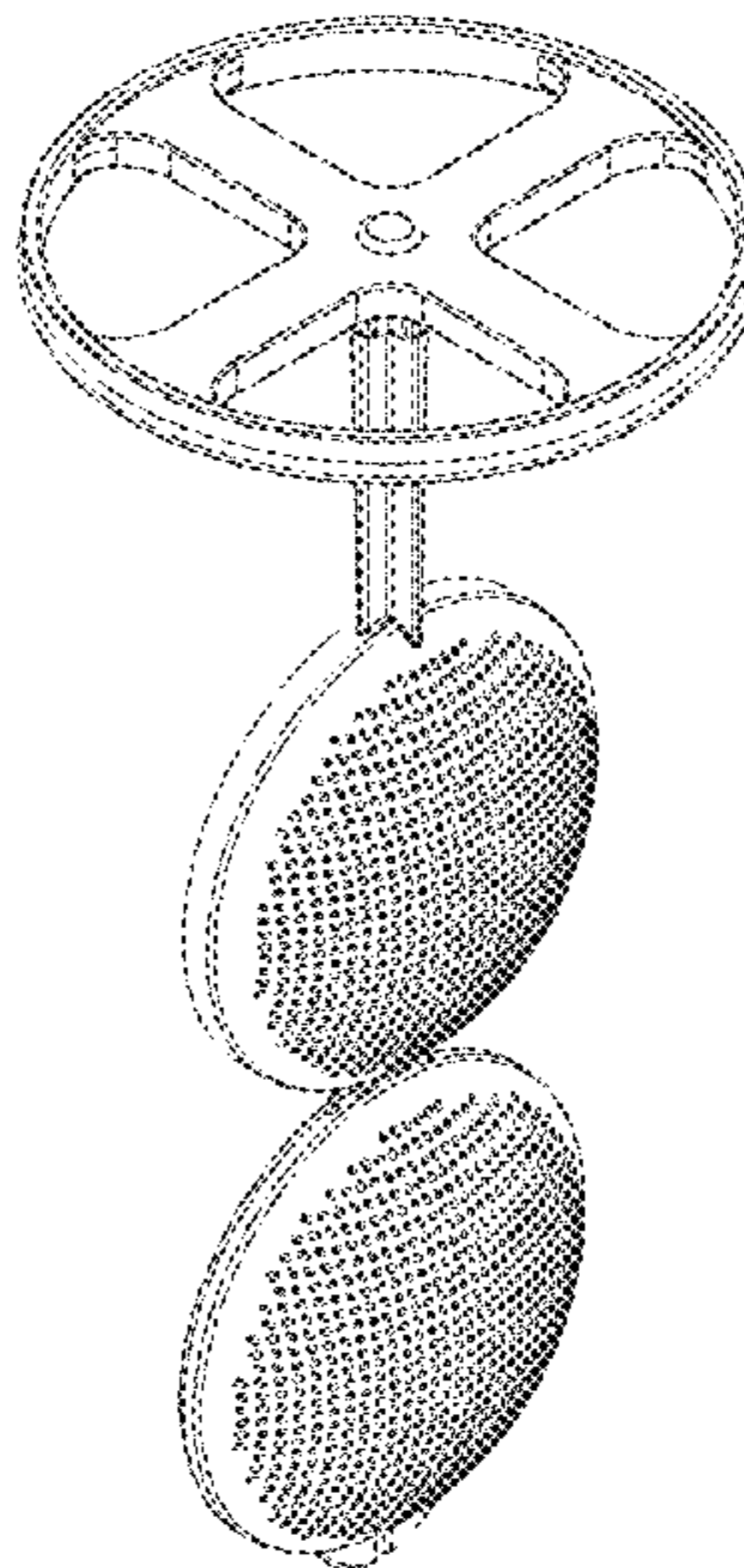
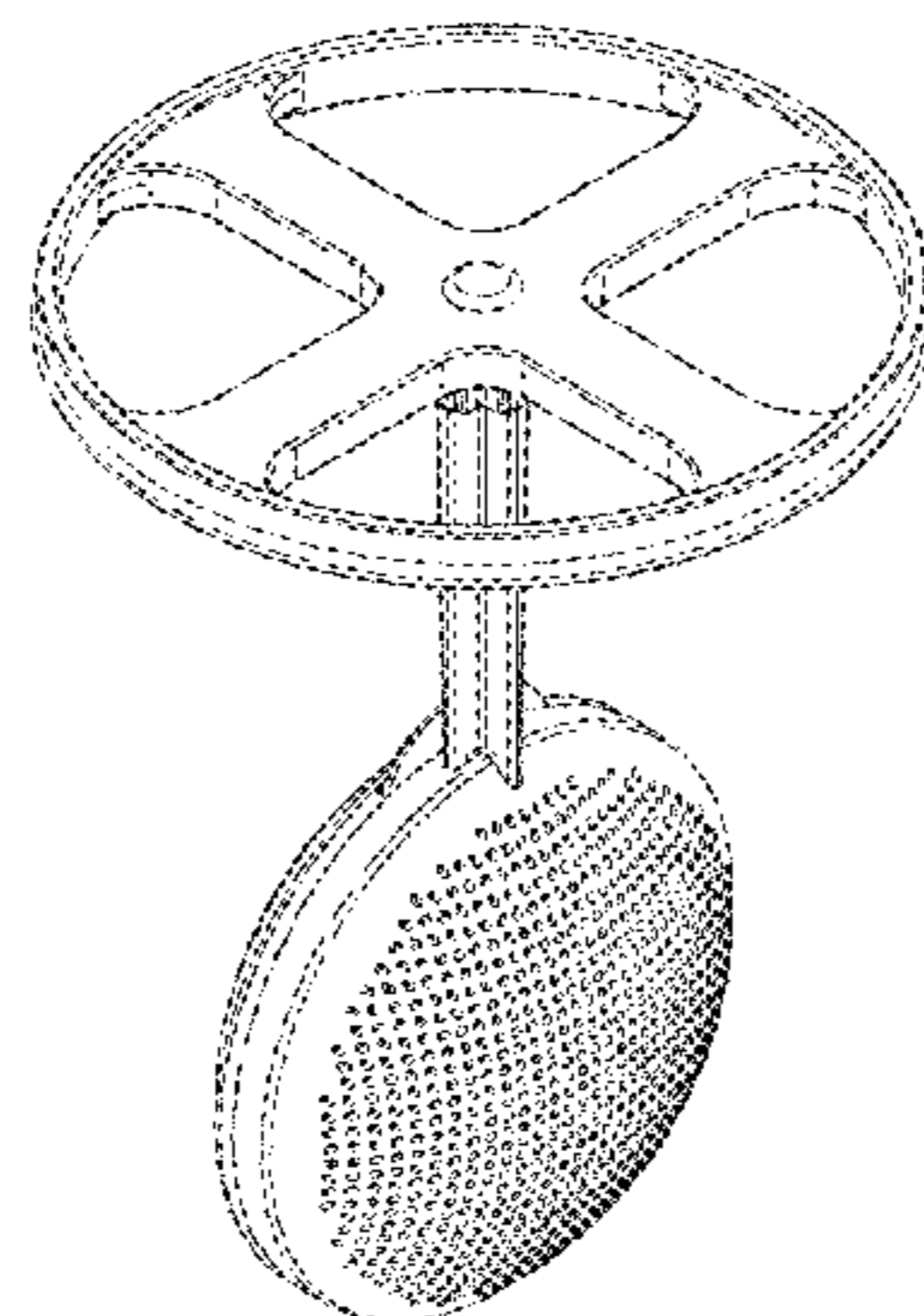

(56)

References Cited

U.S. PATENT DOCUMENTS

1,722,946 A * 7/1929 Raffa A47J 36/22
210/471
2,020,859 A 11/1935 Spalding
2,055,096 A 9/1936 Dehn et al.
2,788,733 A 4/1957 Jacques
3,940,012 A * 2/1976 Addington A47G 19/2211
215/390
5,461,968 A * 10/1995 Portman A47J 31/20
99/287
5,570,623 A * 11/1996 Lin A47J 41/0077
99/285
6,168,816 B1 1/2001 Hammond
D439,470 S * 3/2001 Durbin D7/400
6,202,542 B1 3/2001 Melton
RE37,137 E * 4/2001 Ghidini A47J 43/1081
366/256
D449,960 S * 11/2001 Durbin D7/399
D475,821 S * 6/2003 DesForges D32/25
D485,122 S * 1/2004 Multari D7/400
D506,633 S * 6/2005 Dick-Read D7/300.2
D511,933 S * 11/2005 Abrams D7/400

D571,610 S * 6/2008 Bodum D7/397
D588,870 S * 3/2009 Rasmussen D7/397
D608,142 S * 1/2010 Davies D7/397
7,946,752 B2 5/2011 Swartz et al.
D714,548 S * 10/2014 Roberts D3/264
8,893,610 B2 * 11/2014 Haverstock A47J 31/20
99/297
2004/0069148 A1 * 4/2004 Fenaroli A47G 19/16
99/275
2006/0118481 A1 6/2006 Trachtenbroit
2007/0042083 A1 * 2/2007 Larkin B65D 85/812
426/77
2007/0251955 A1 * 11/2007 Green B67D 3/0035
222/185.1
2012/0279398 A1 11/2012 Sproul et al.
2015/0020690 A1 * 1/2015 Vernon A47G 19/16
99/323

FOREIGN PATENT DOCUMENTS

GB 334624 9/1930
KR 20-2009-0005514 U 6/2009

* cited by examiner

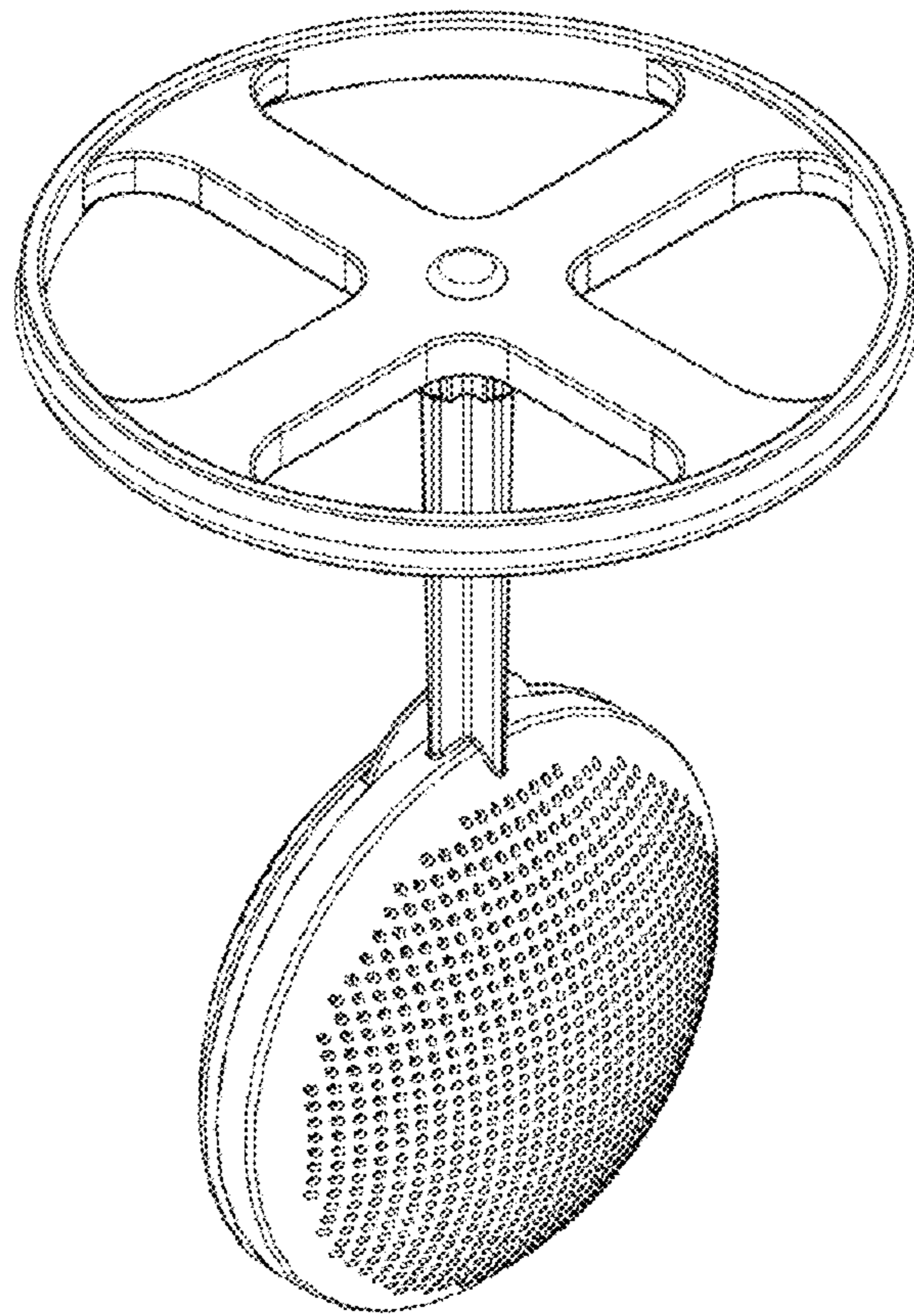

FIG. 1

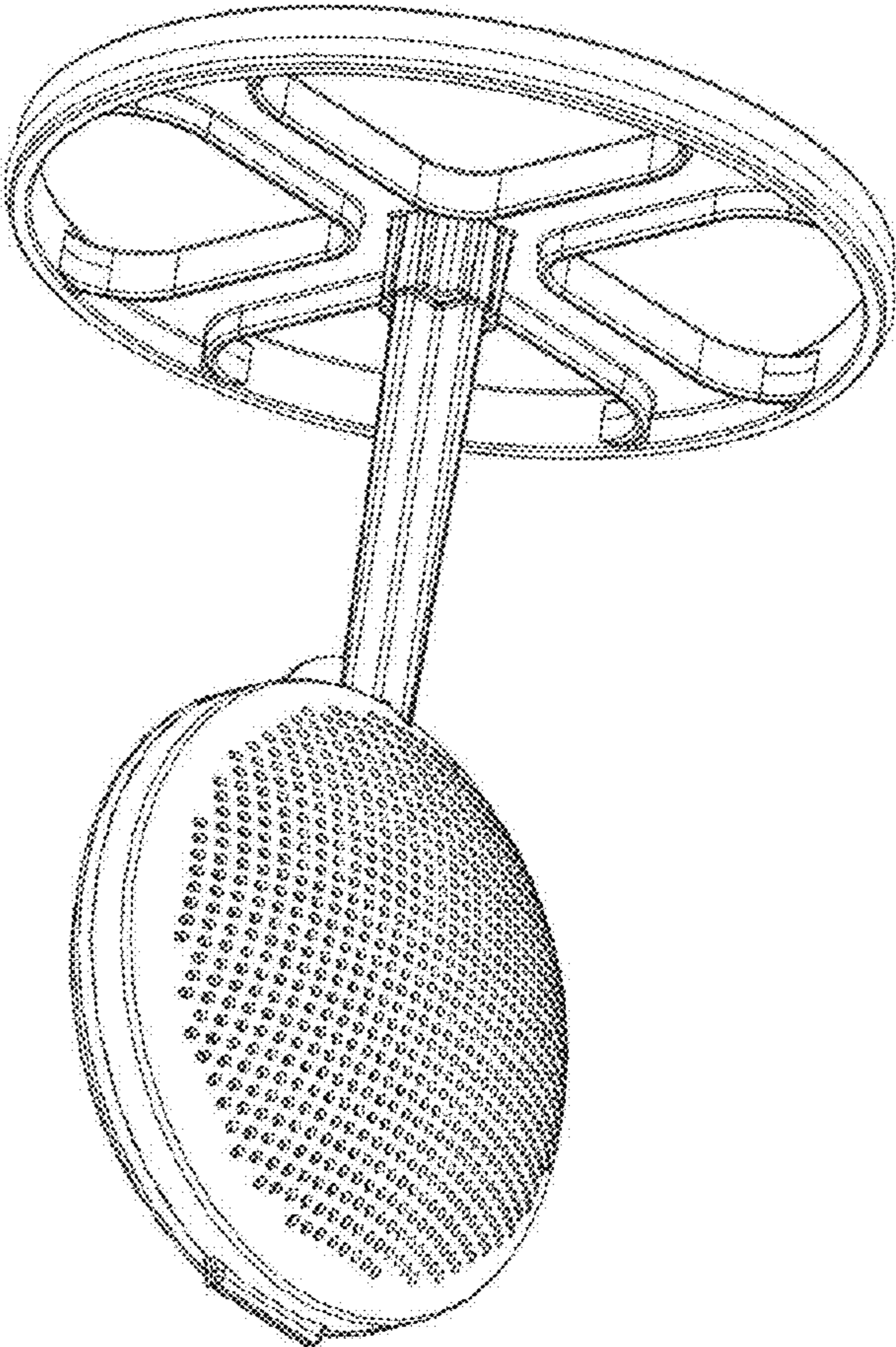

FIG. 2

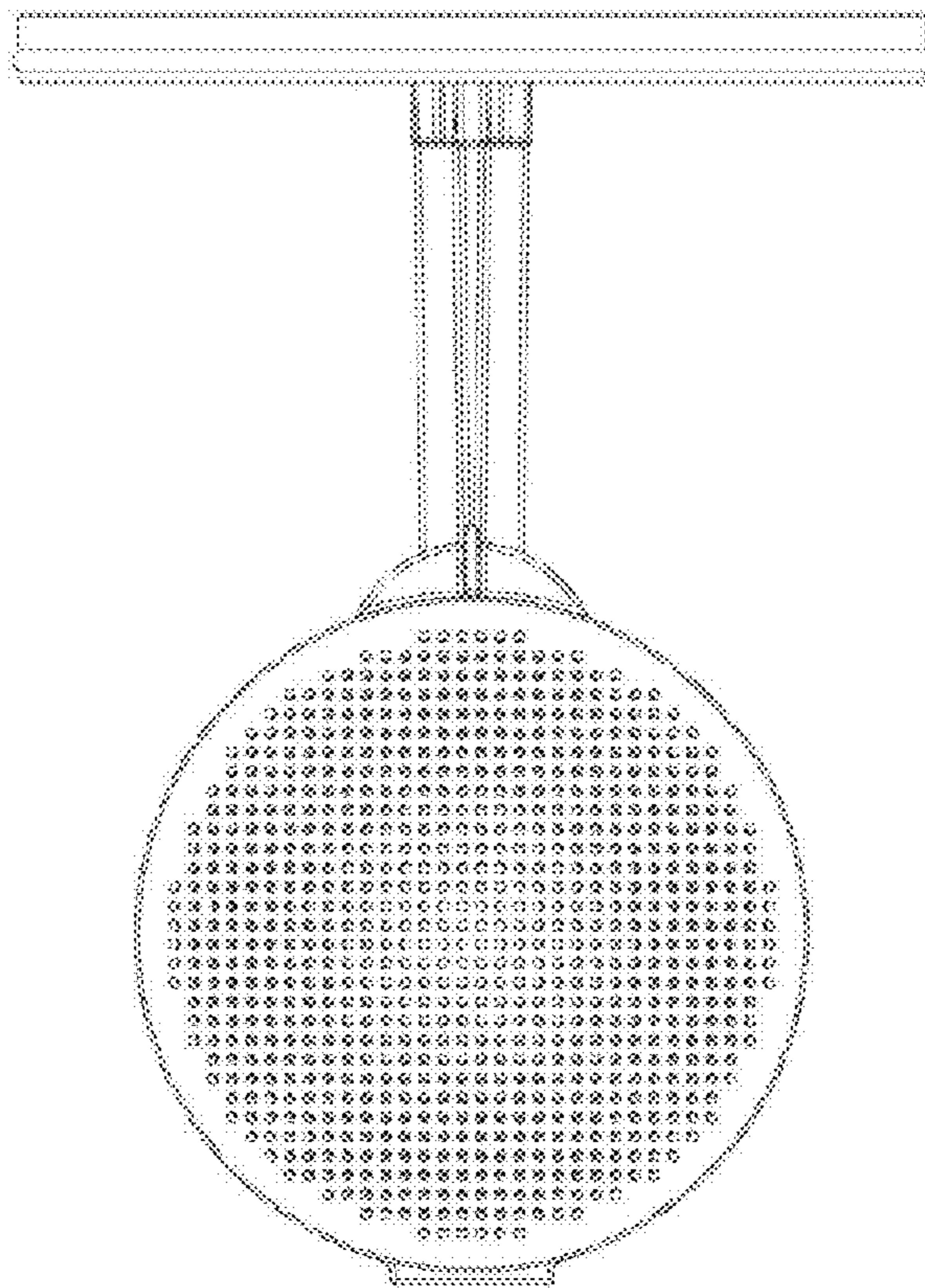

FIG. 3

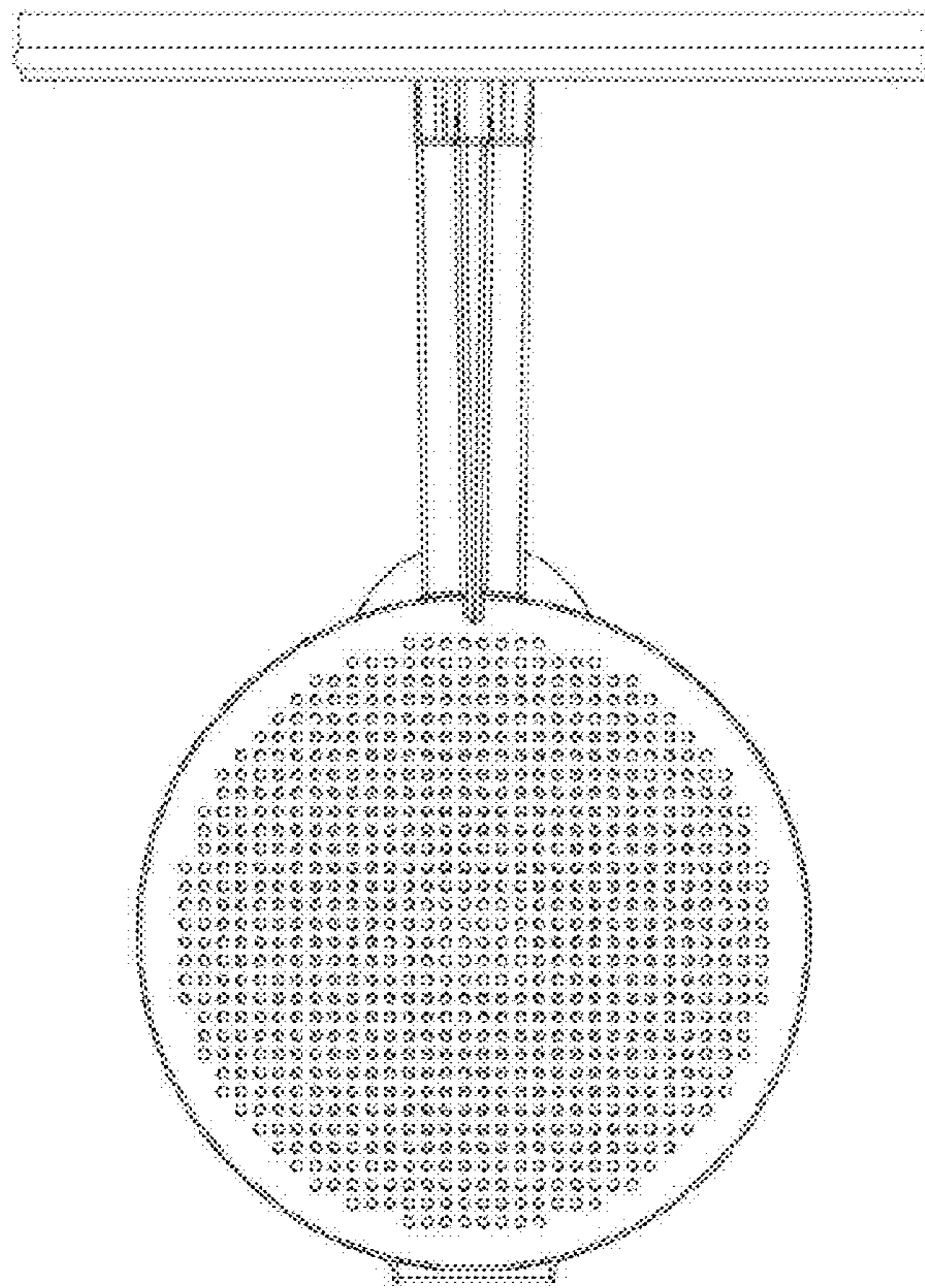

FIG. 4

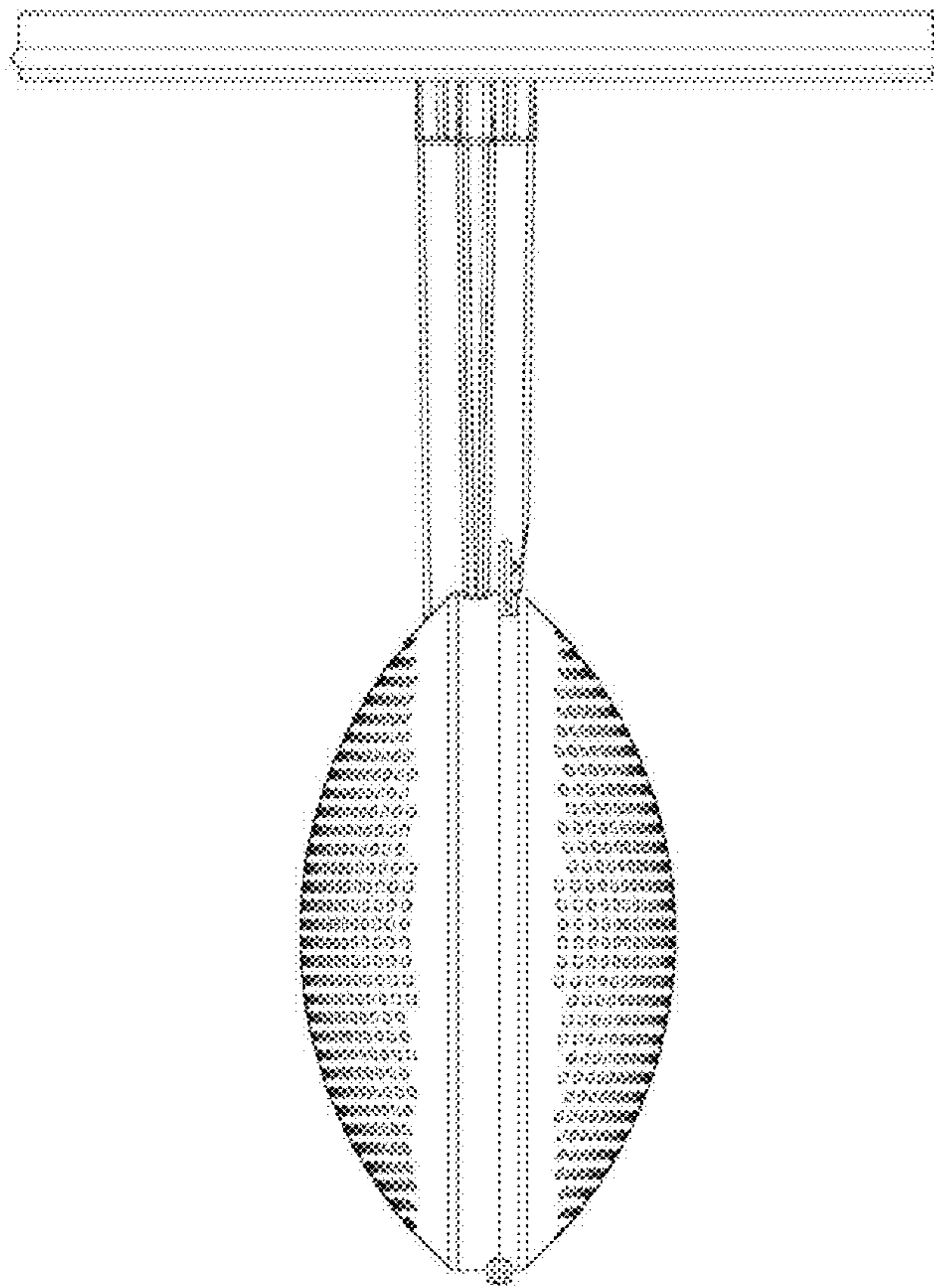

FIG. 5

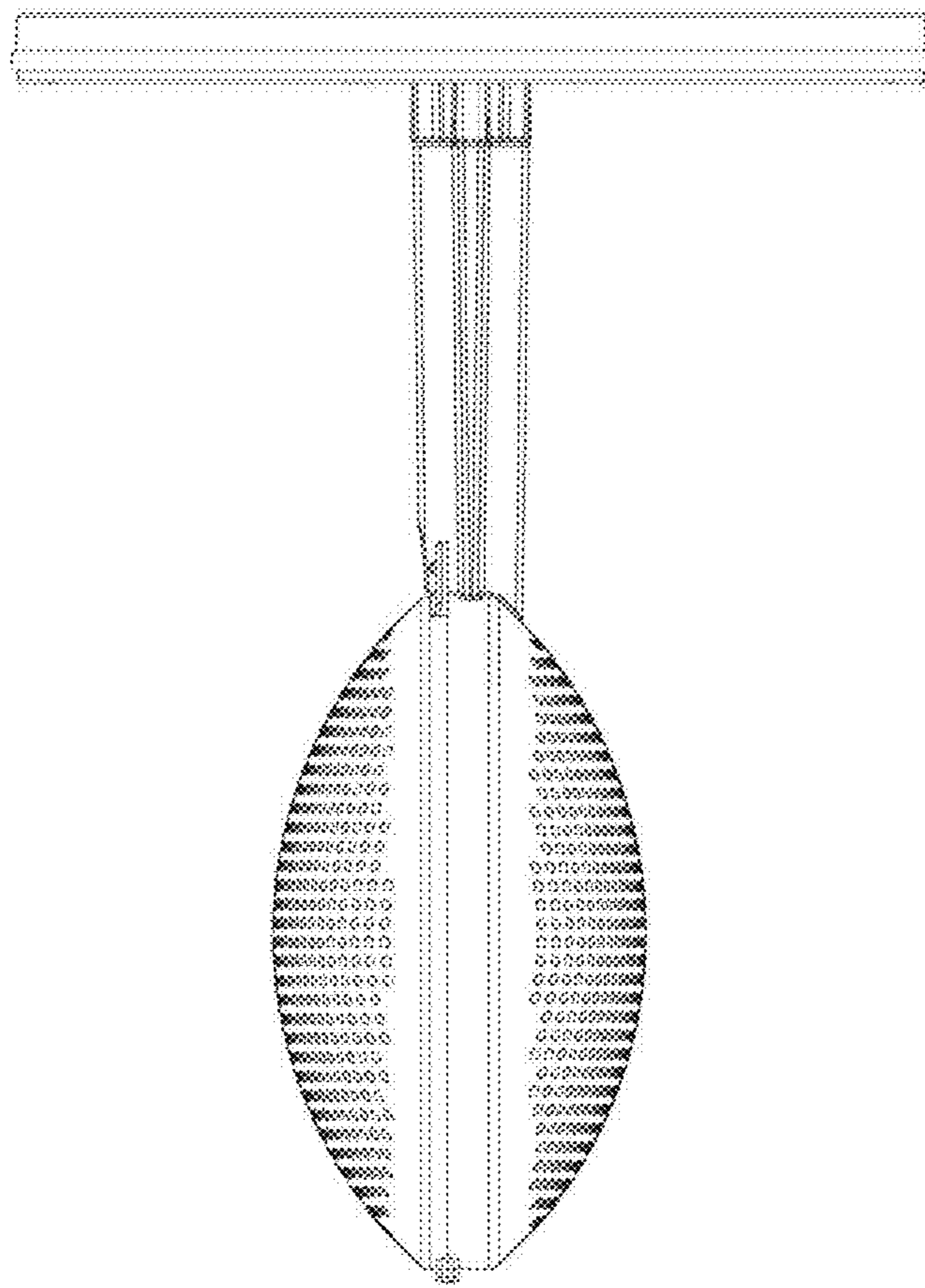

FIG. 6

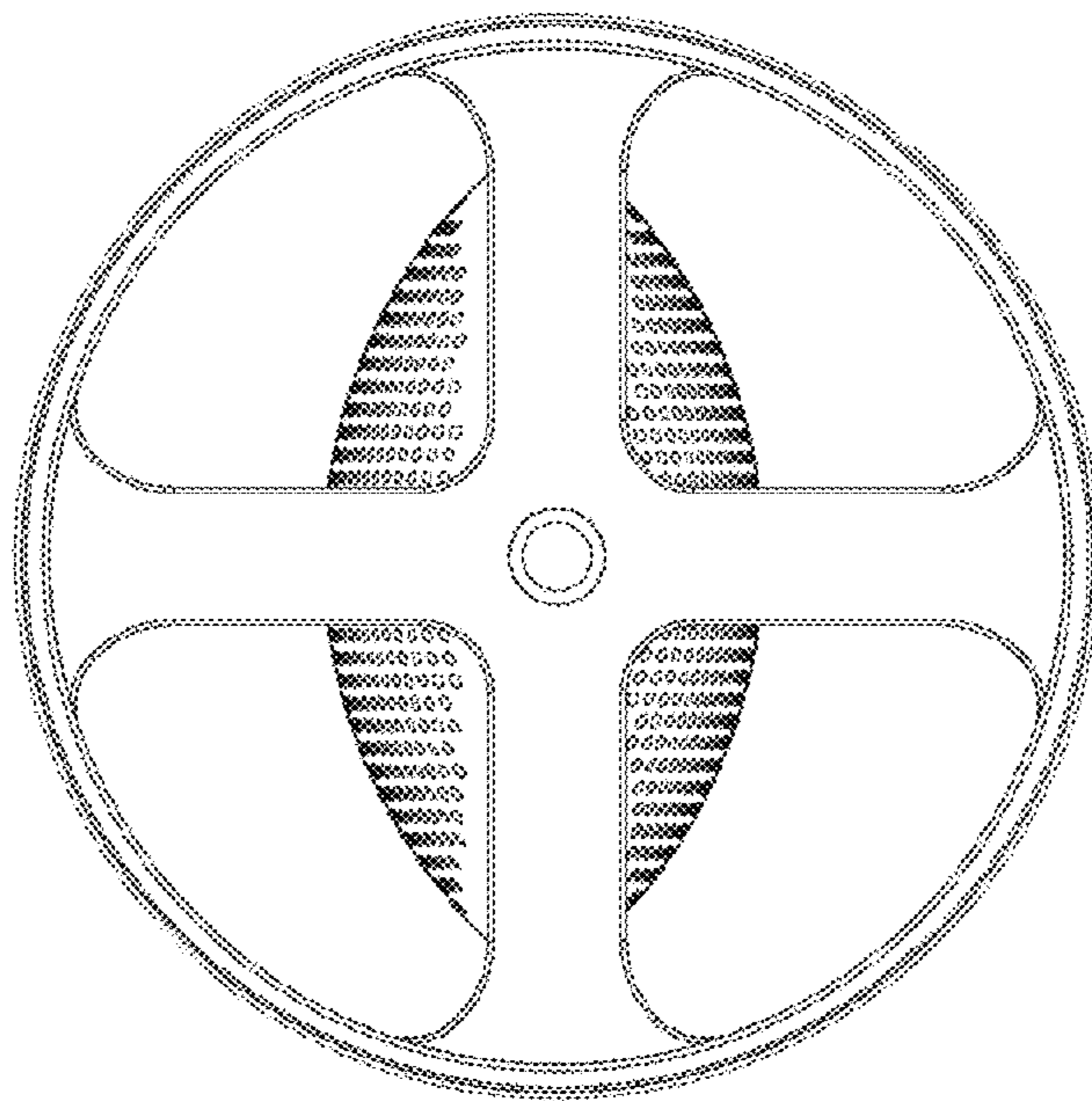

FIG. 7

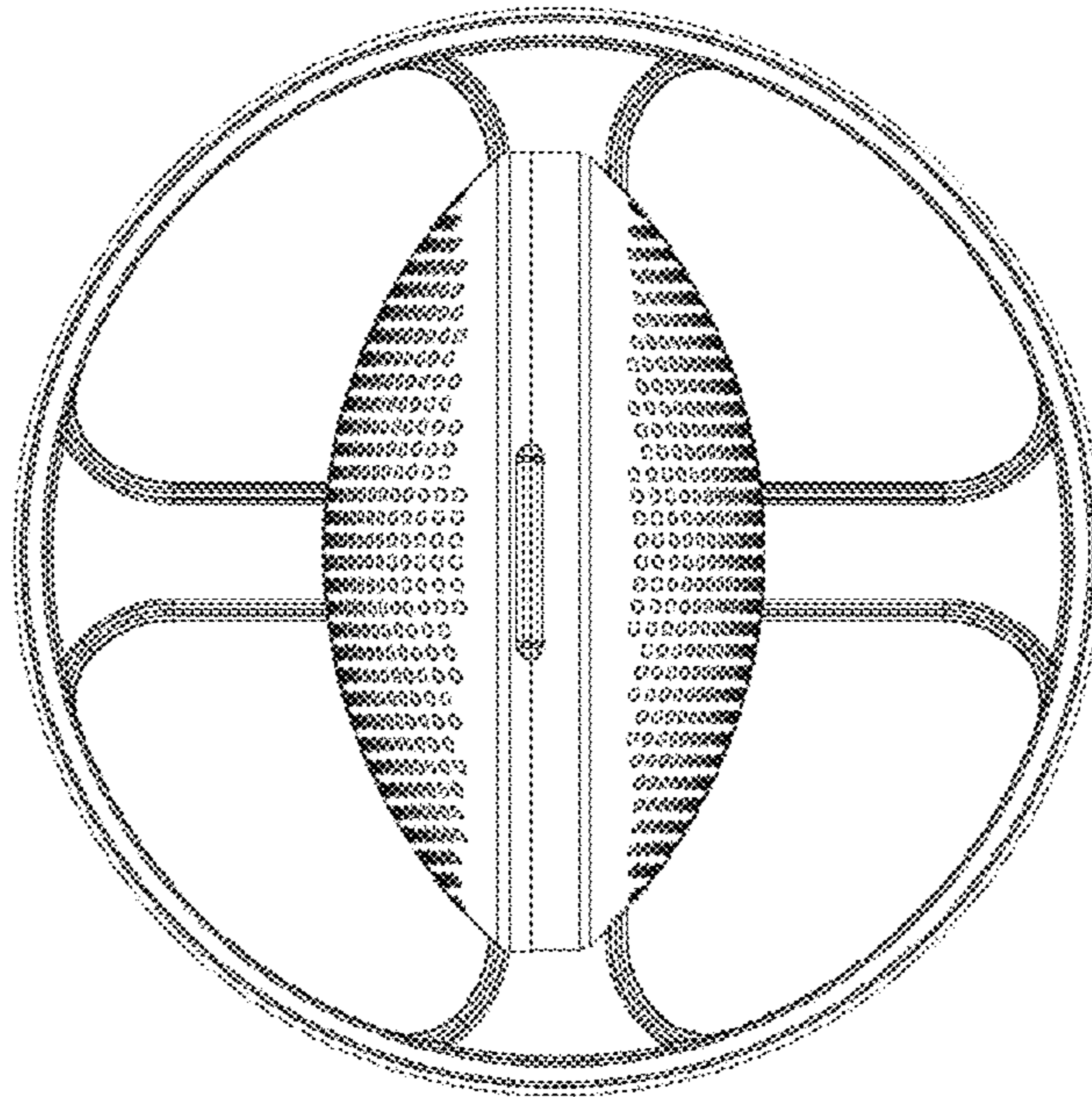

FIG. 8

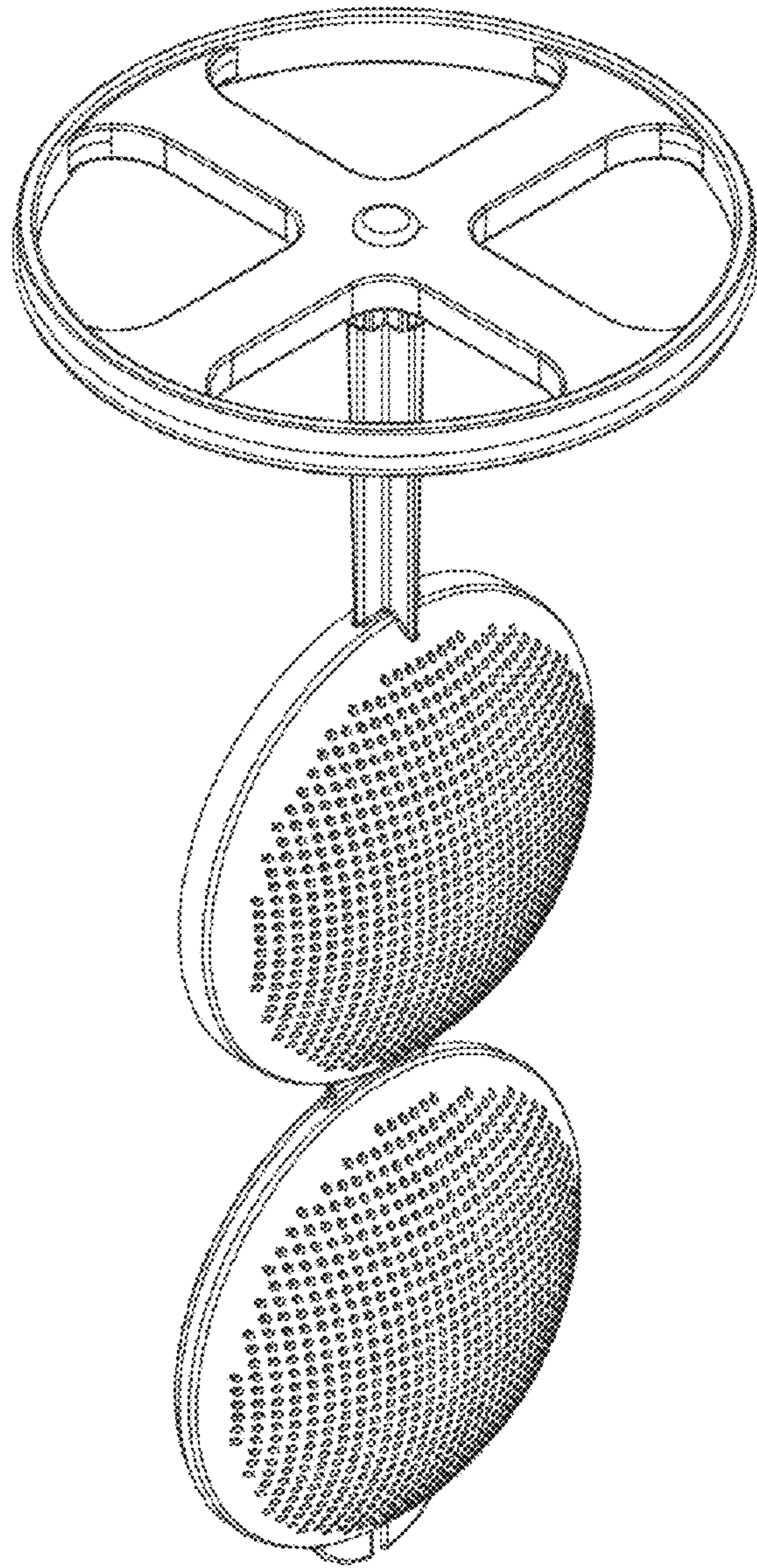

FIG. 9

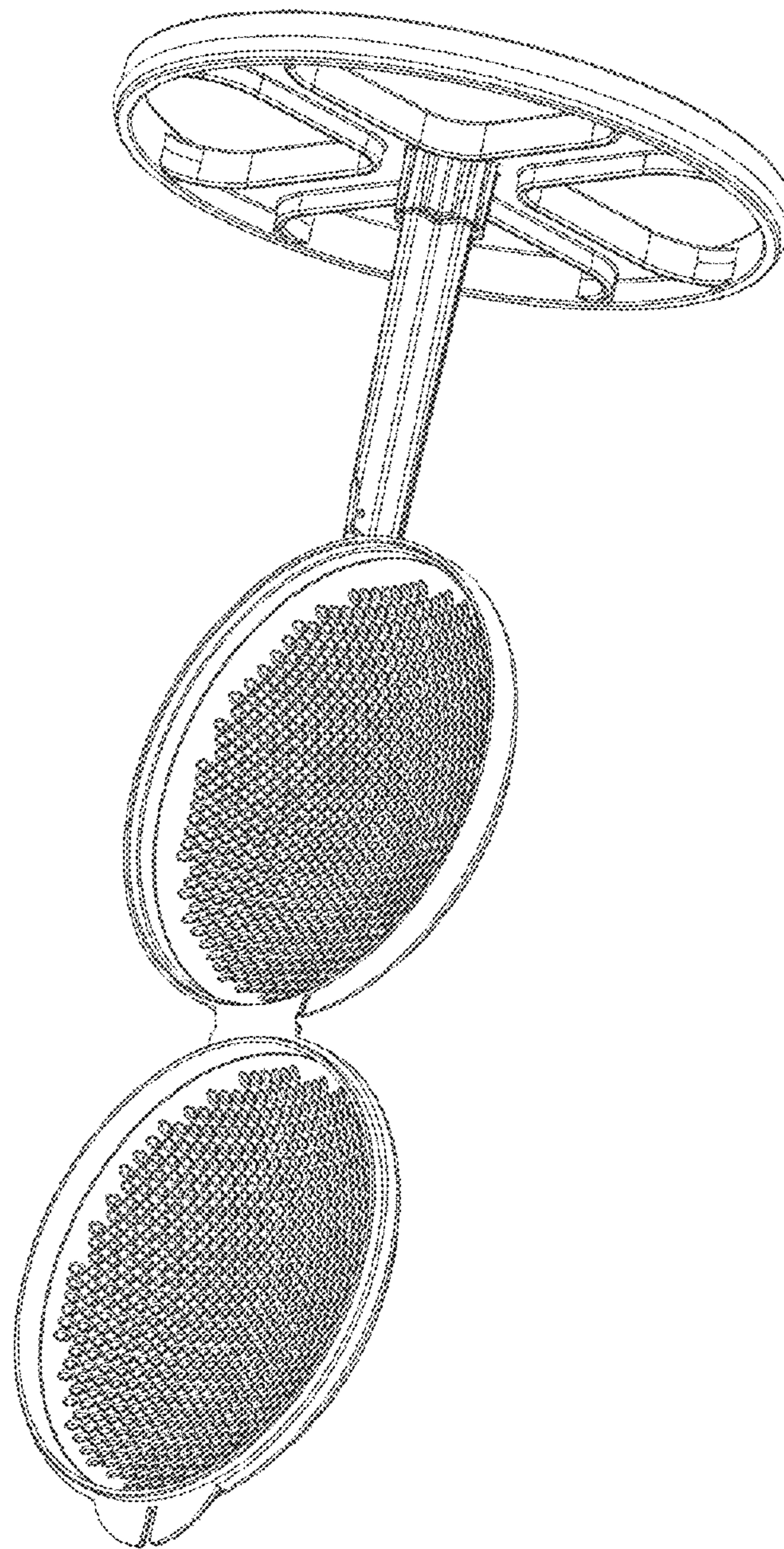

FIG.10

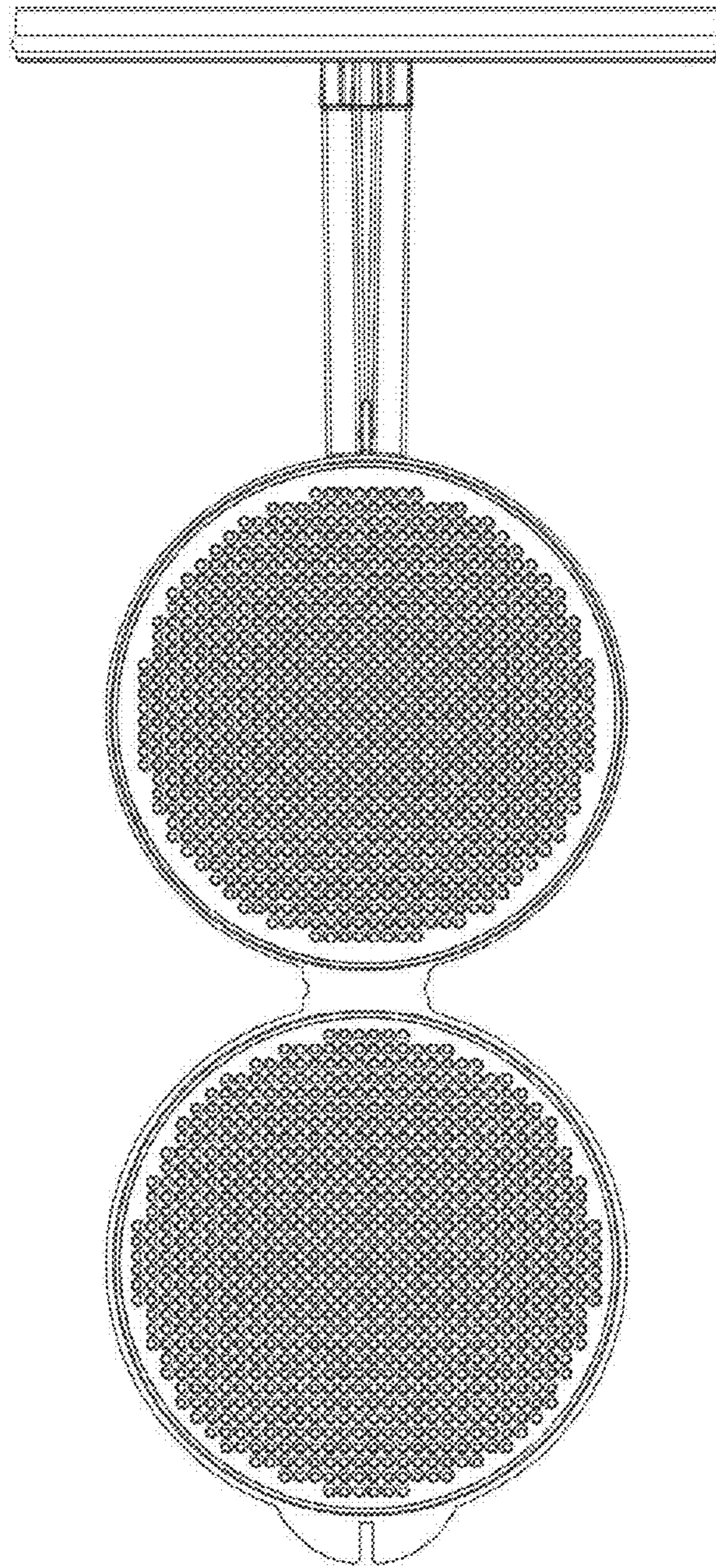

FIG. 11

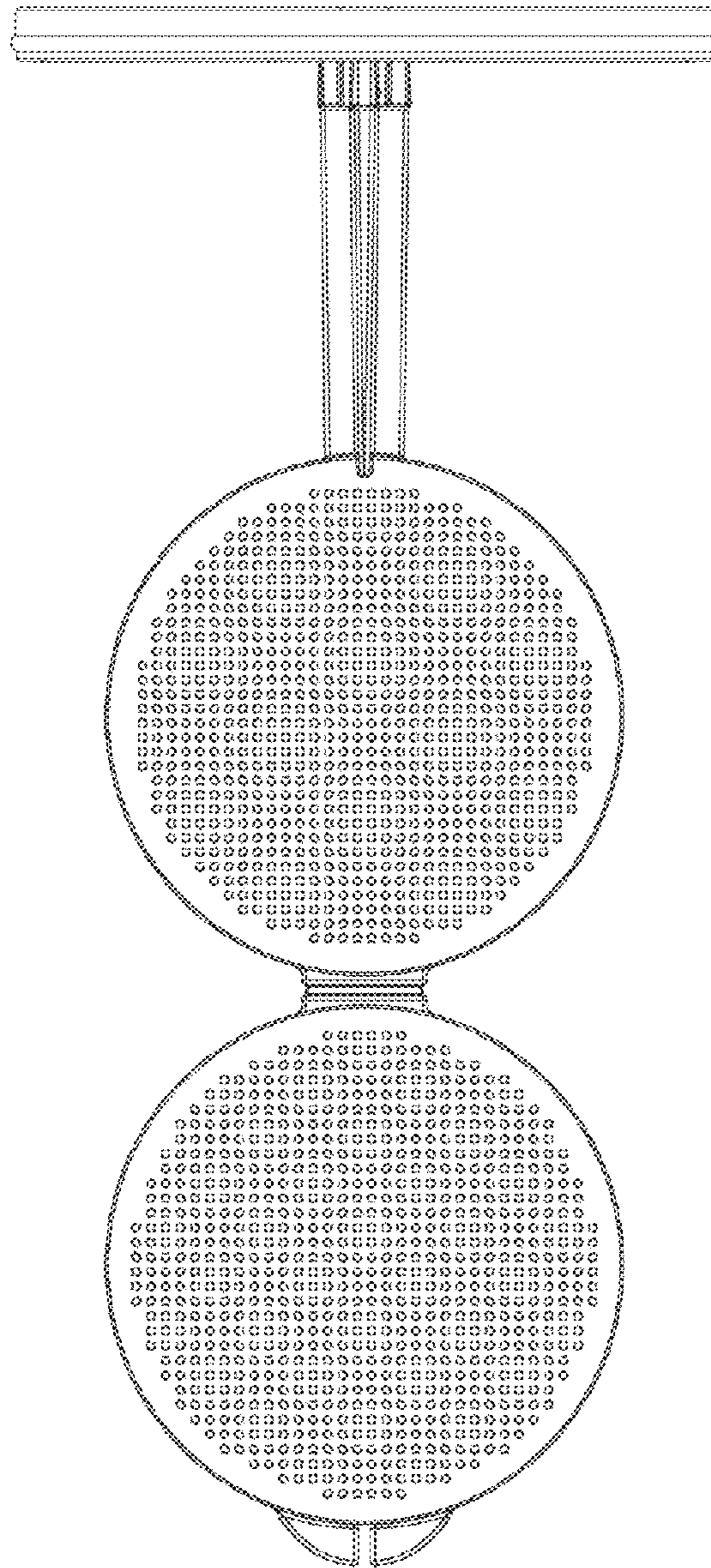

FIG. 12

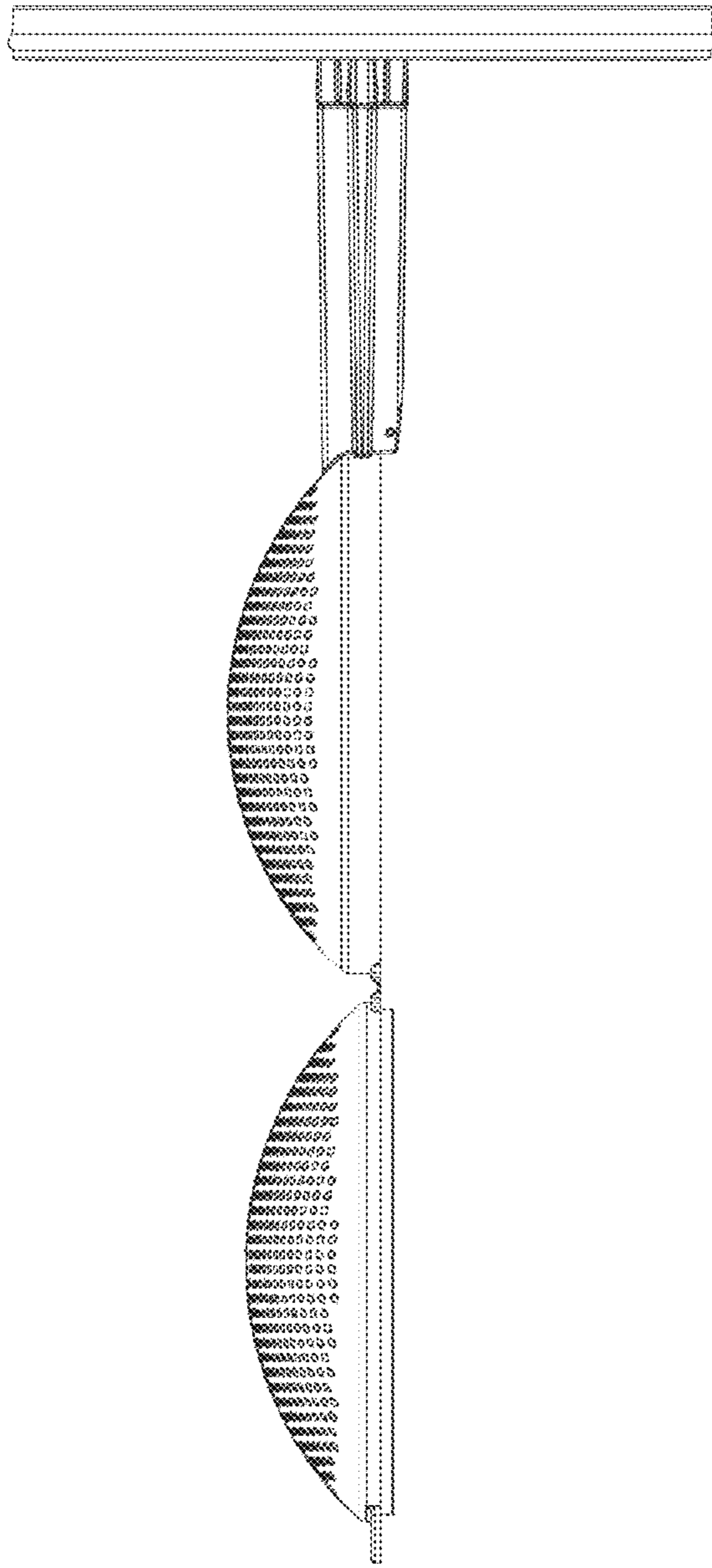

FIG. 13

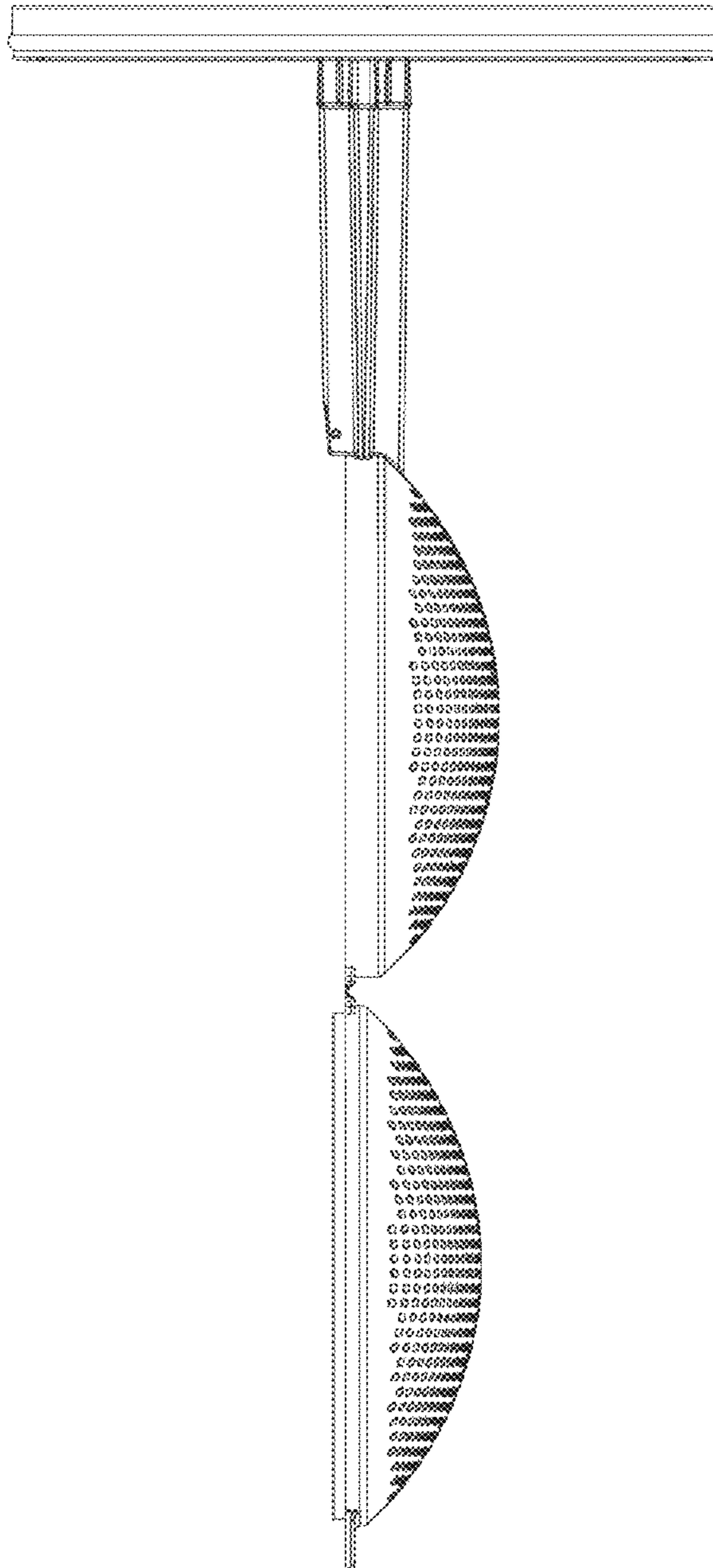

FIG. 14

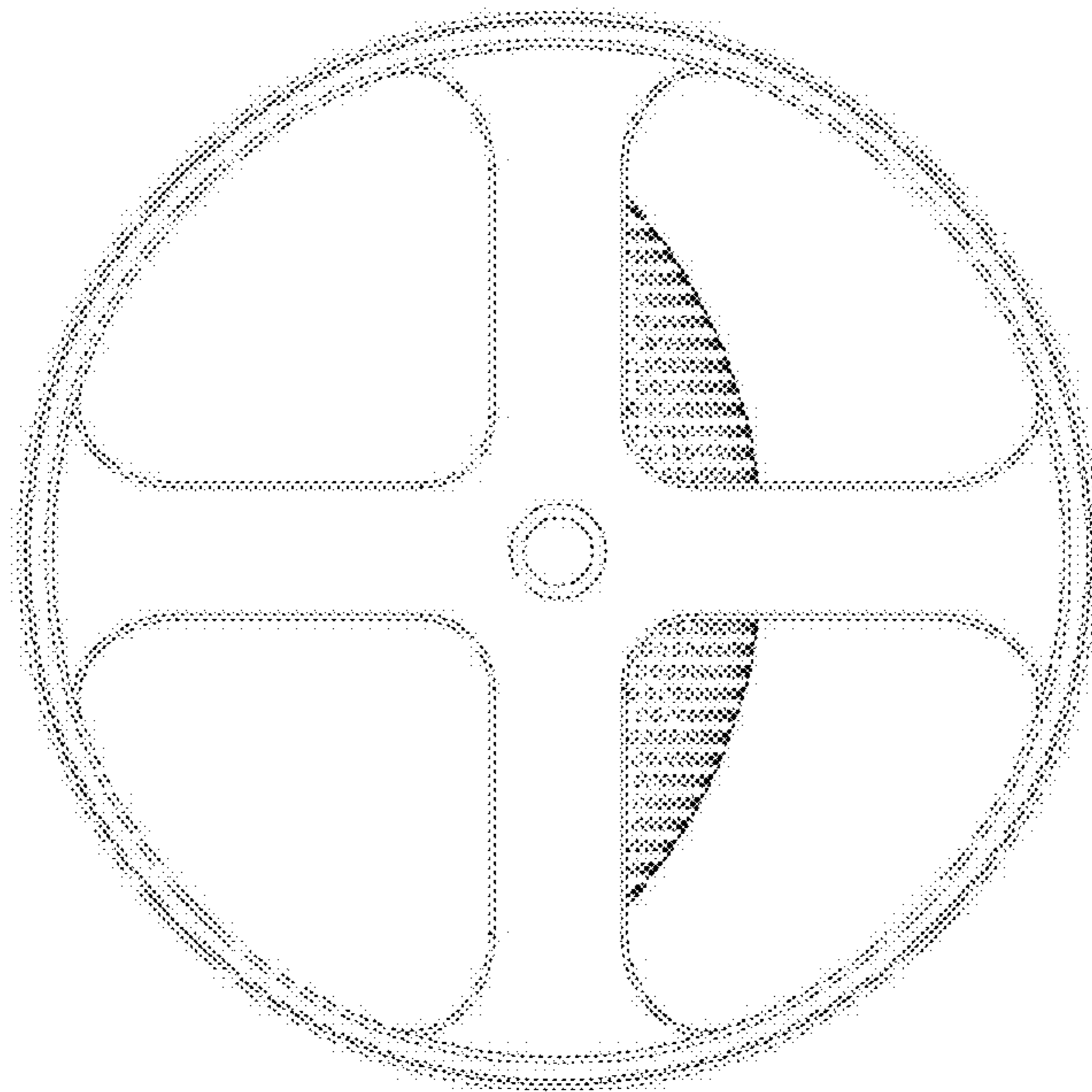

FIG. 15

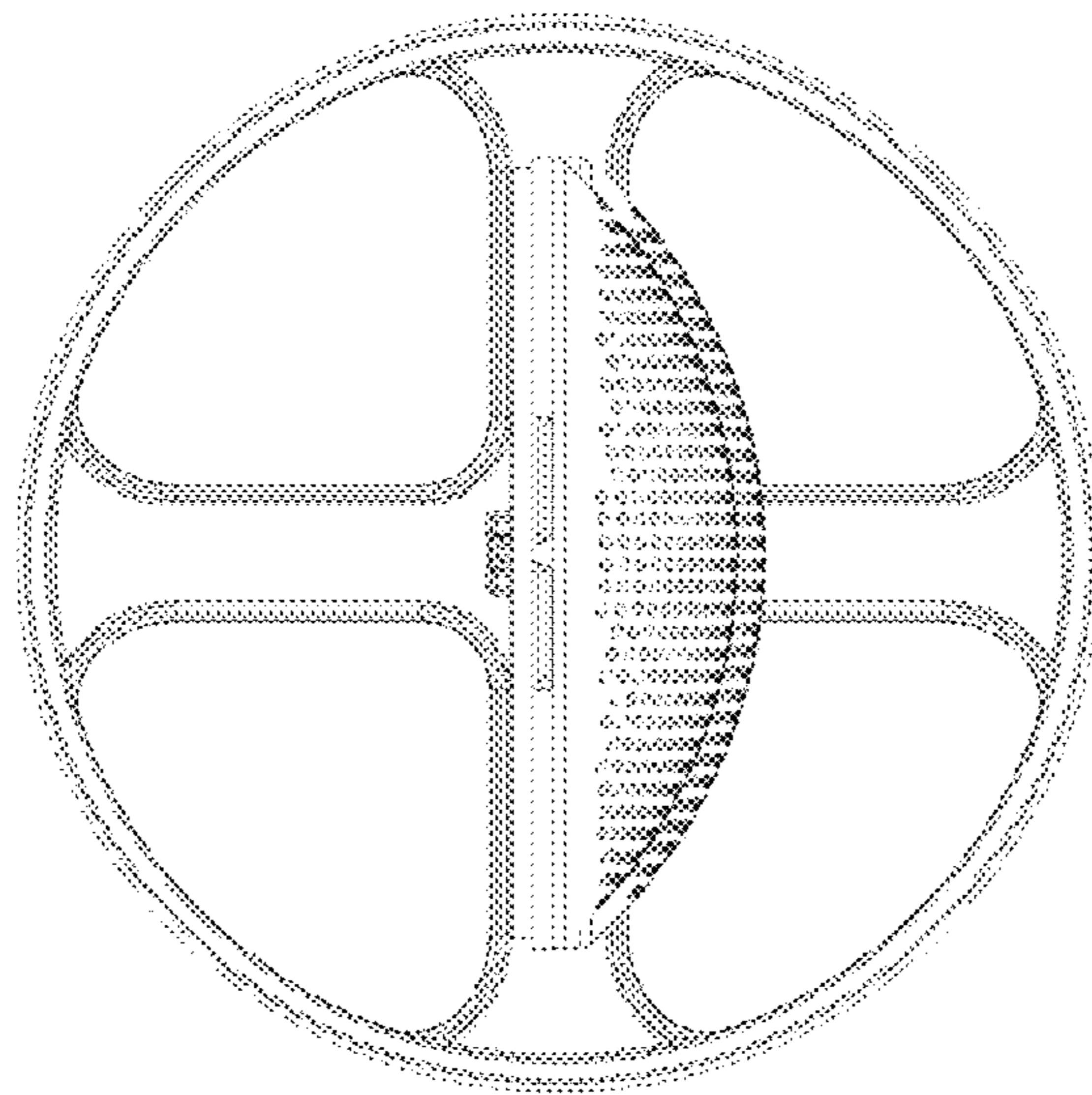

FIG. 16