



US00D750412S

(12) **United States Design Patent**
Gagnon et al.

(10) **Patent No.:** **US D750,412 S**
(45) **Date of Patent:** **** Mar. 1, 2016**

(54) **COFFEE MAKER**

(71) Applicant: **8479950 CANADA INC.**, Montreal (CA)

(72) Inventors: **Martin Gagnon**, Quebec (CA); **Shae Hong**, New York, NY (US)

(73) Assignee: **8479950 Canada Inc.**, Montreal (CA)

(**) Term: **14 Years**

(21) Appl. No.: **29/500,192**

(22) Filed: **Aug. 22, 2014**

(51) **LOC (10) Cl.** **07-01**

(52) **U.S. Cl.**
USPC **D7/309**; D7/311; D7/399

(58) **Field of Classification Search**
USPC D7/306-311, 305, 300, 313, 399, 398, D7/397; 99/279, 284, 290, 280, 299, 307, 99/305, 295, 308, 309, 323.1, 395, 300; 222/23, 129.1; 62/395; D20/1; D23/207, 209; D15/89
CPC A47J 31/44; A47J 31/00; B67D 1/0041; B67D 3/00

See application file for complete search history.

(56) **References Cited**

U.S. PATENT DOCUMENTS

D217,650 S *	5/1970	Cofgren	D15/82
D218,069 S *	7/1970	Cornelius et al.	D15/81
D223,648 S *	5/1972	Hartley	D15/82
D387,946 S *	12/1997	Hippen	D7/309
D536,917 S *	2/2007	McWilliam	D7/309
D553,897 S *	10/2007	De' Longhi	D7/309
D600,491 S *	9/2009	Hammad	D7/306
D601,848 S *	10/2009	Borin	D7/307
D626,367 S *	11/2010	Gross	D7/301

D669,727 S *	10/2012	Pagano	D7/307
D681,385 S *	5/2013	Ring	D7/306
D696,056 S *	12/2013	Hong	D7/309
D718,414 S *	11/2014	Lo	D23/207
D738,153 S *	9/2015	Brook	D7/309

* cited by examiner

Primary Examiner — Marianne Pandozzi

(74) *Attorney, Agent, or Firm* — Taft Stettinus & Hollister LLP

(57) **CLAIM**

We claim the ornamental design for a coffee maker, as shown and described.

DESCRIPTION

FIG. 1 is a perspective view taken from a top, front, right side of a first embodiment of the coffee maker; FIG. 2 is a front elevation view thereof; FIG. 3 is a rear elevation view thereof; FIG. 4 is a left side elevation view thereof; FIG. 5 is a right side elevation view thereof; FIG. 6 is a top plan view thereof; FIG. 7 is a bottom plan view thereof; FIG. 8 is a perspective view taken from a top, front, right side of a second embodiment of the coffee maker; FIG. 9 is a front elevation view thereof; FIG. 10 is a rear elevation view thereof; FIG. 11 is a left side elevation view thereof; FIG. 12 is a right side elevation view thereof; FIG. 13 is a top plan view thereof; and, FIG. 14 is a bottom plan view thereof.

Throughout the figures, where shown the dotted lines showing additional structure of the coffee maker are for illustrative purposes only and form no part of the claimed design. Portions of the coffee maker not shown in the Figures and not otherwise described in this Specification do not form part of the claimed design.

1 Claim, 14 Drawing Sheets

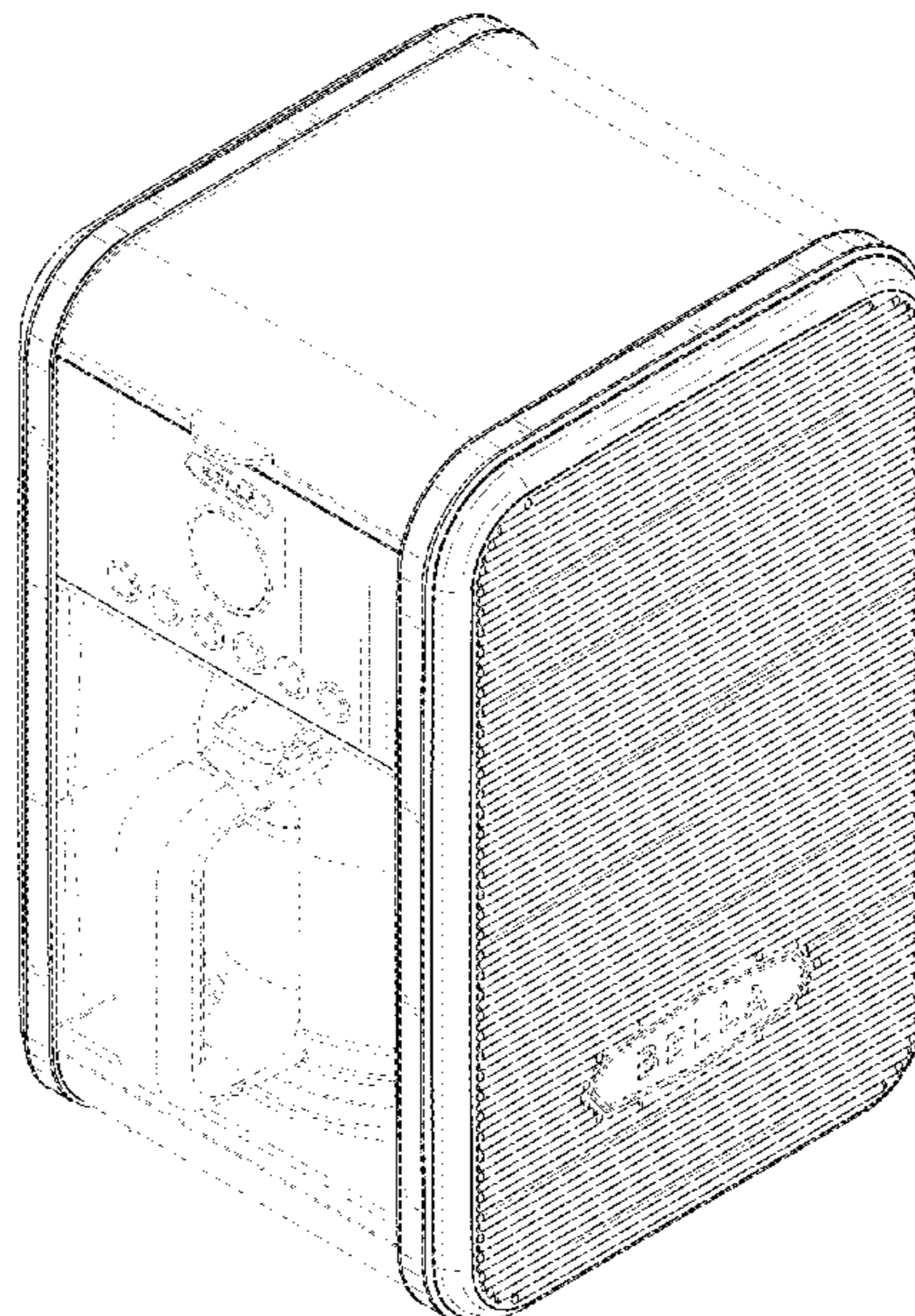

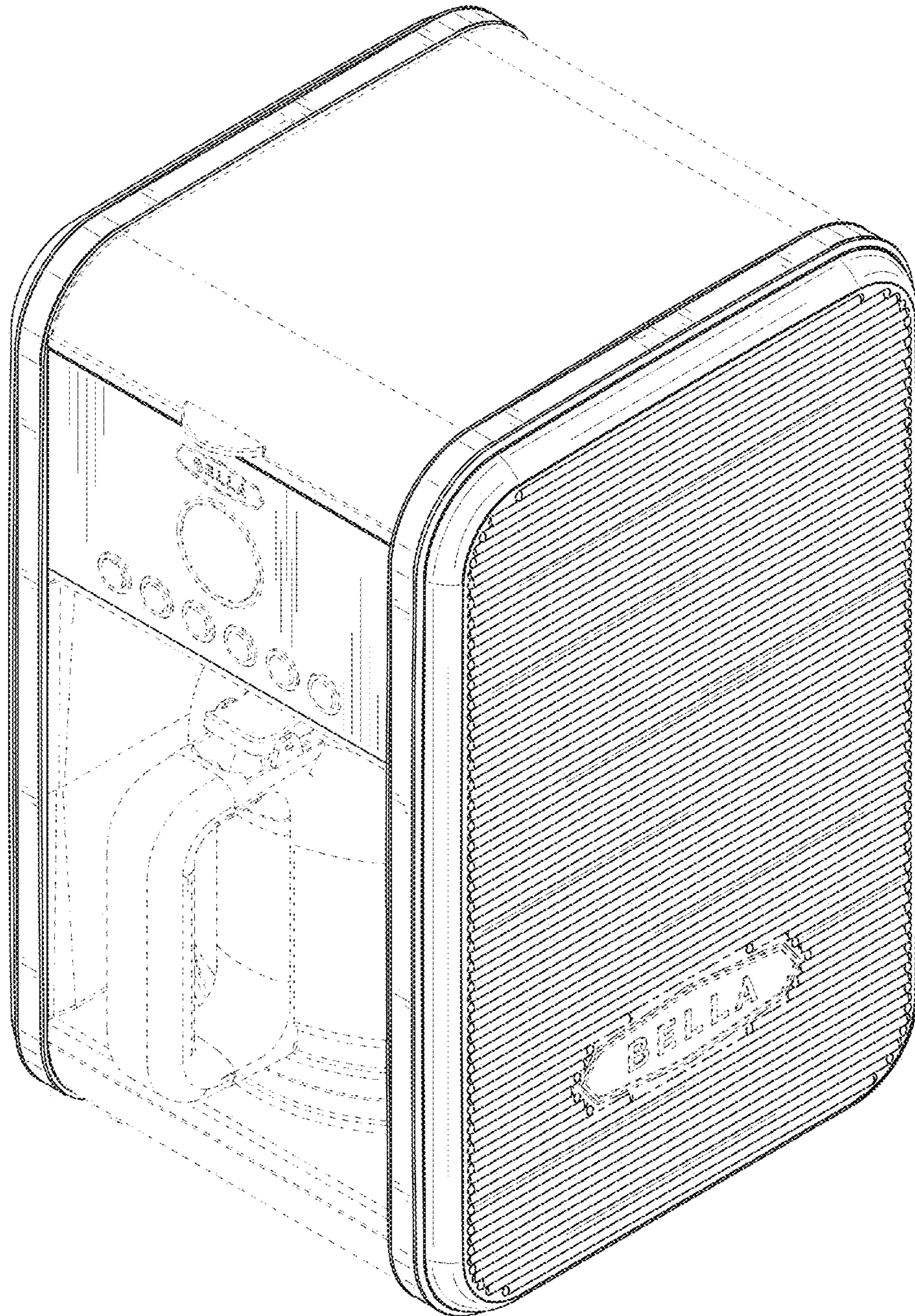

FIG. 1

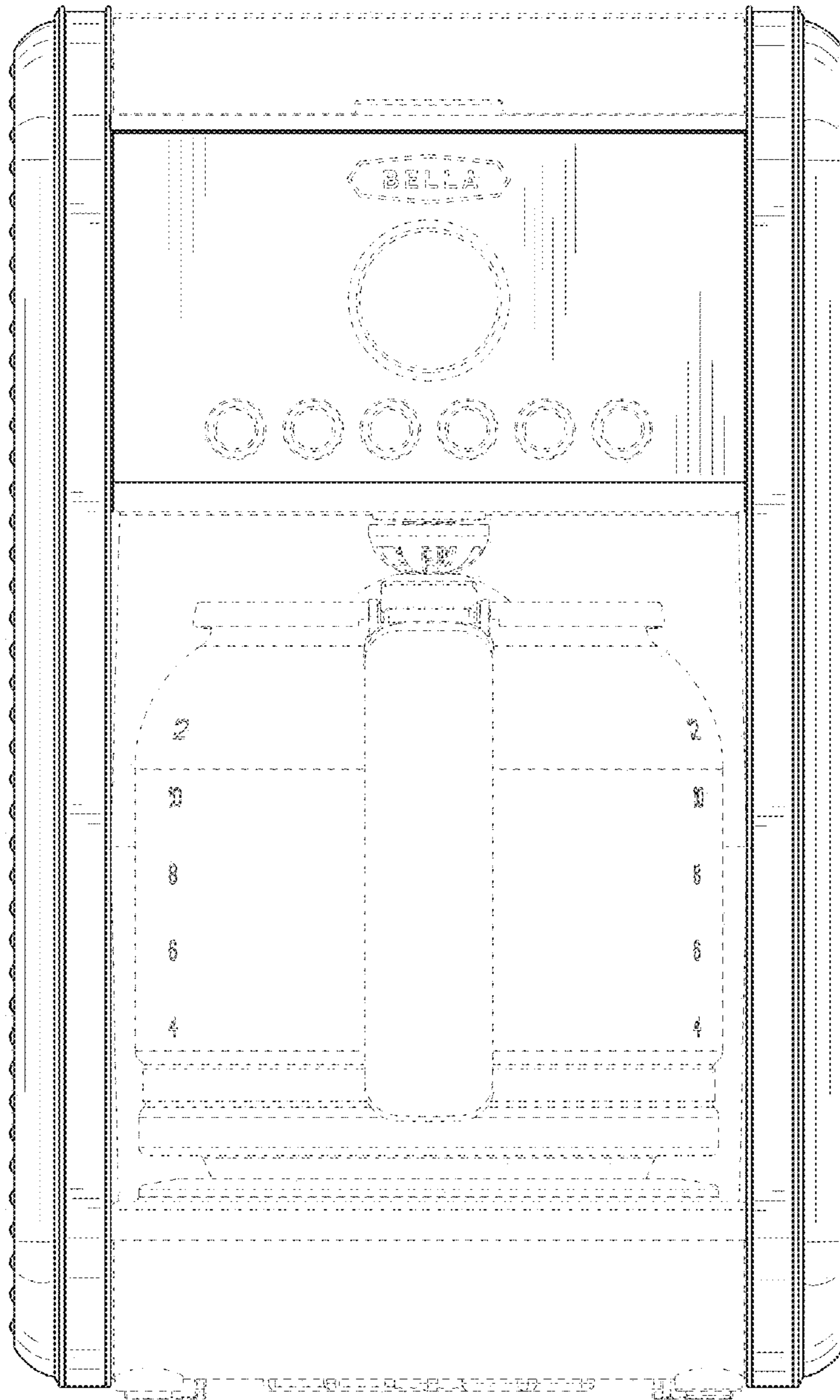

FIG. 2

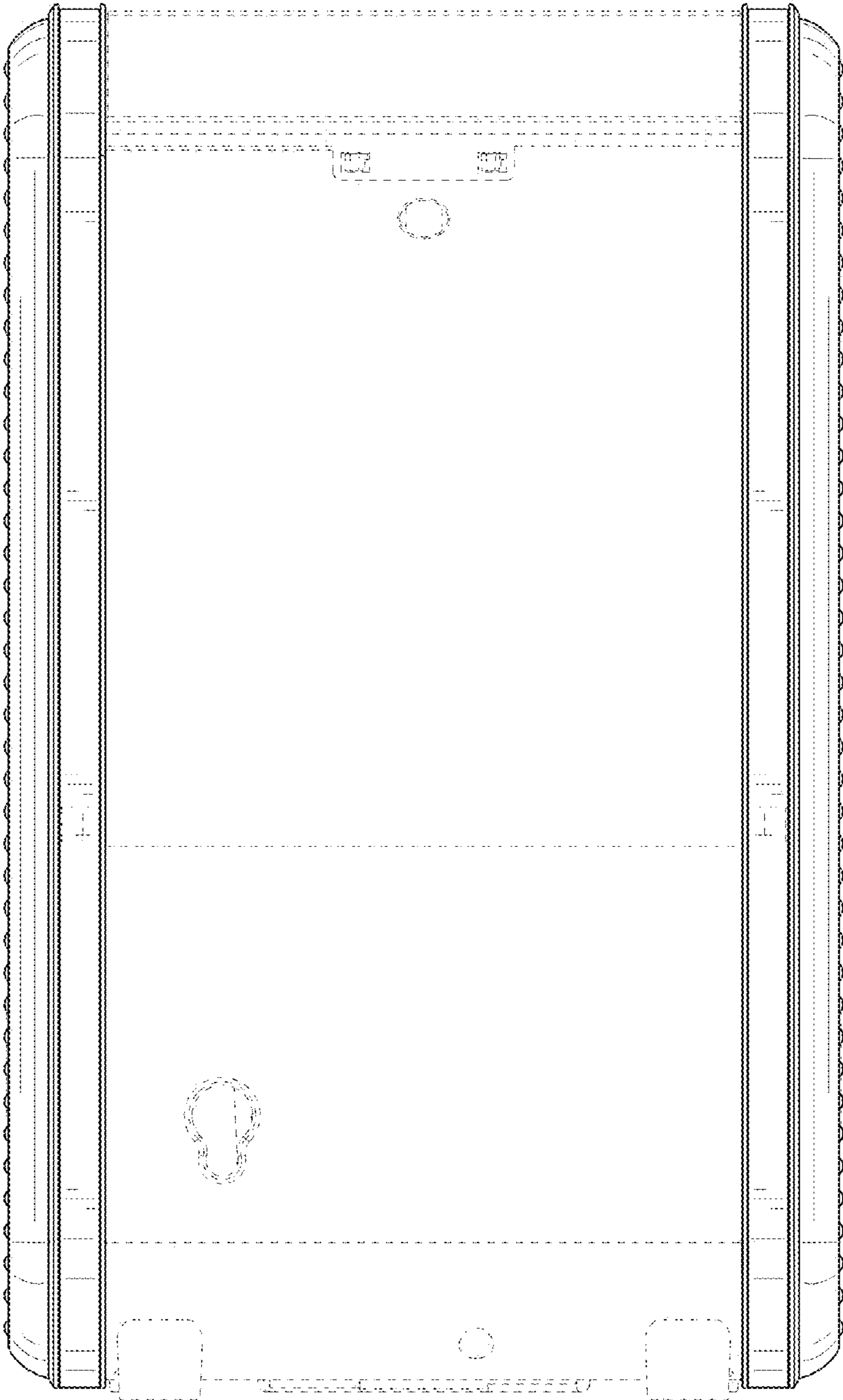

FIG. 3

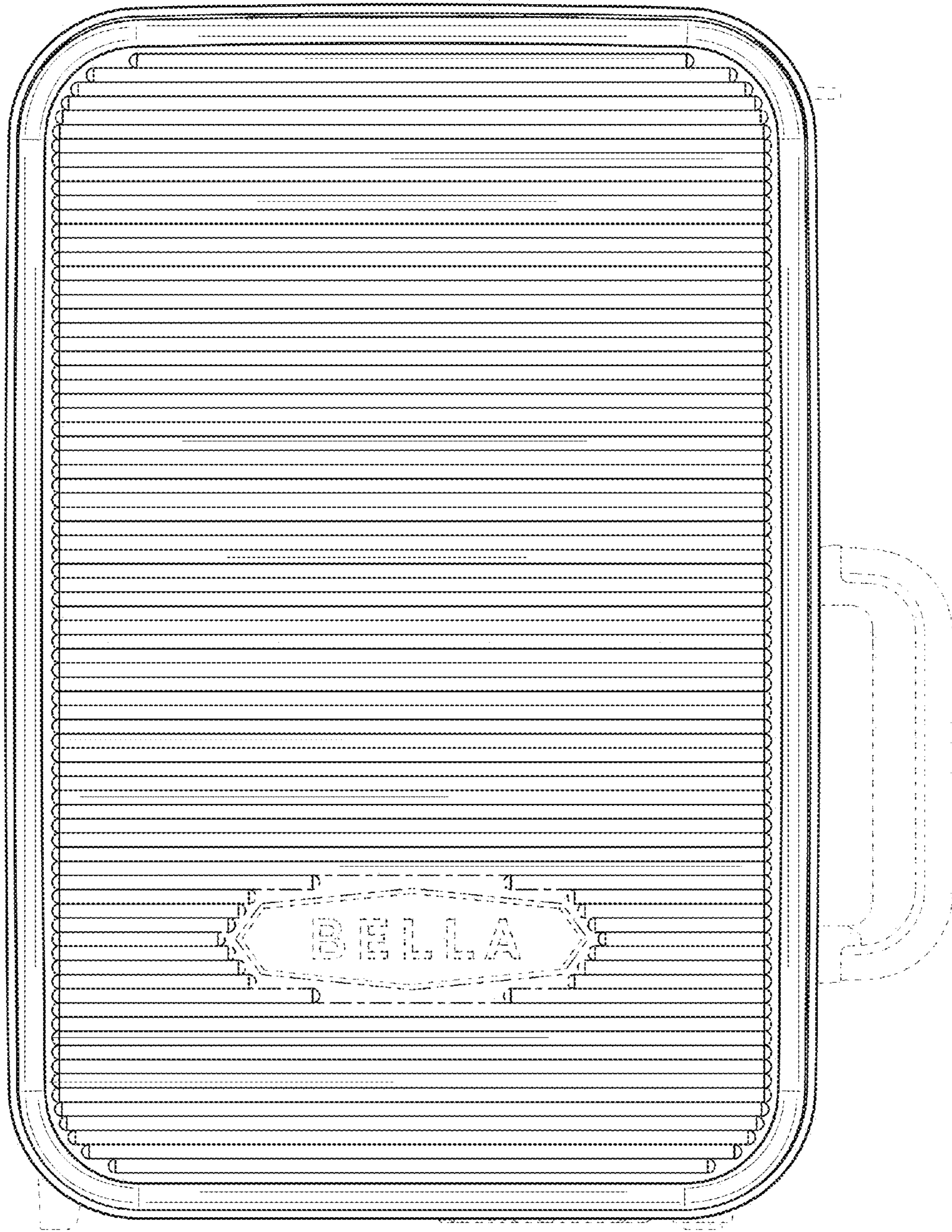

FIG. 4

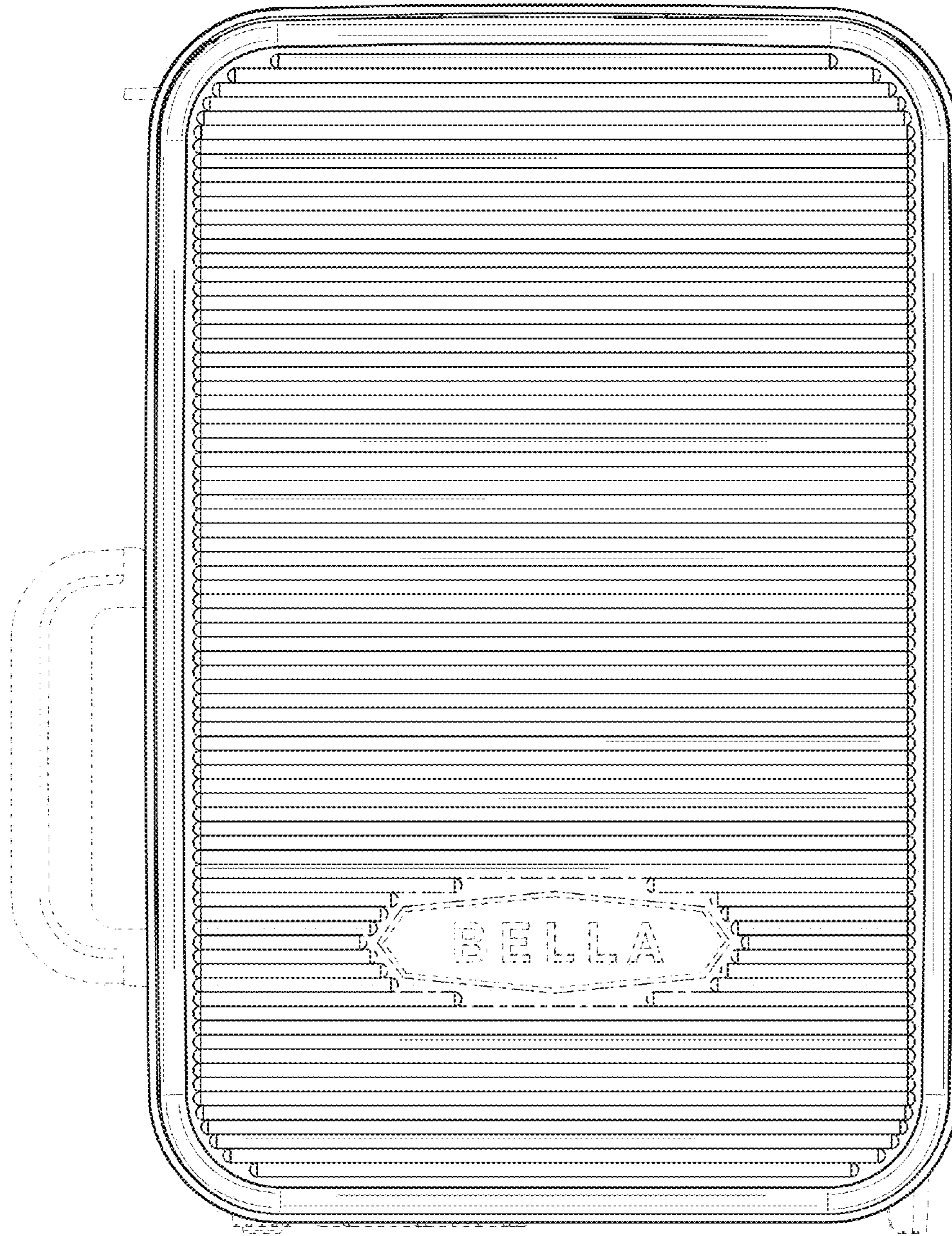

FIG. 5

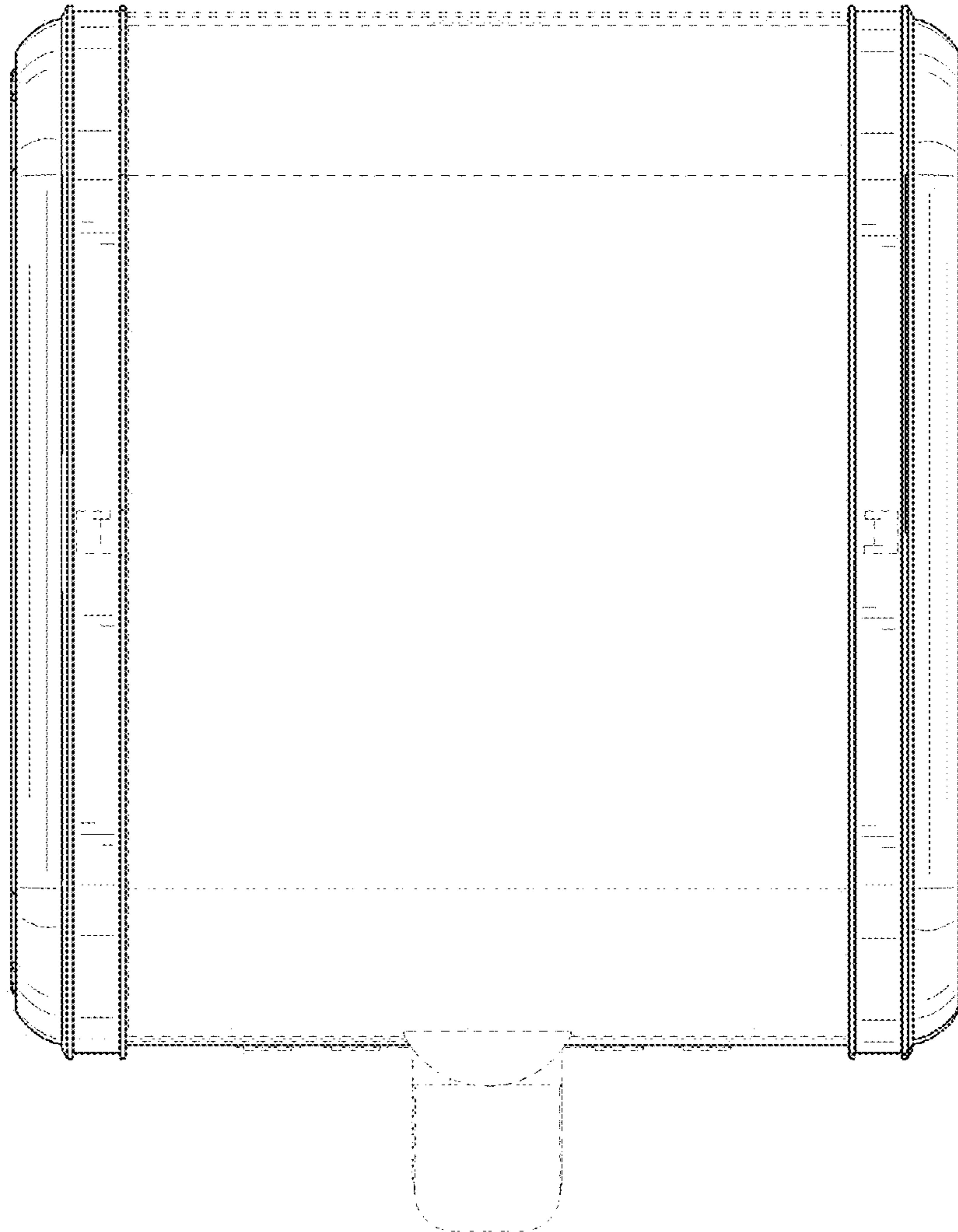

FIG. 6

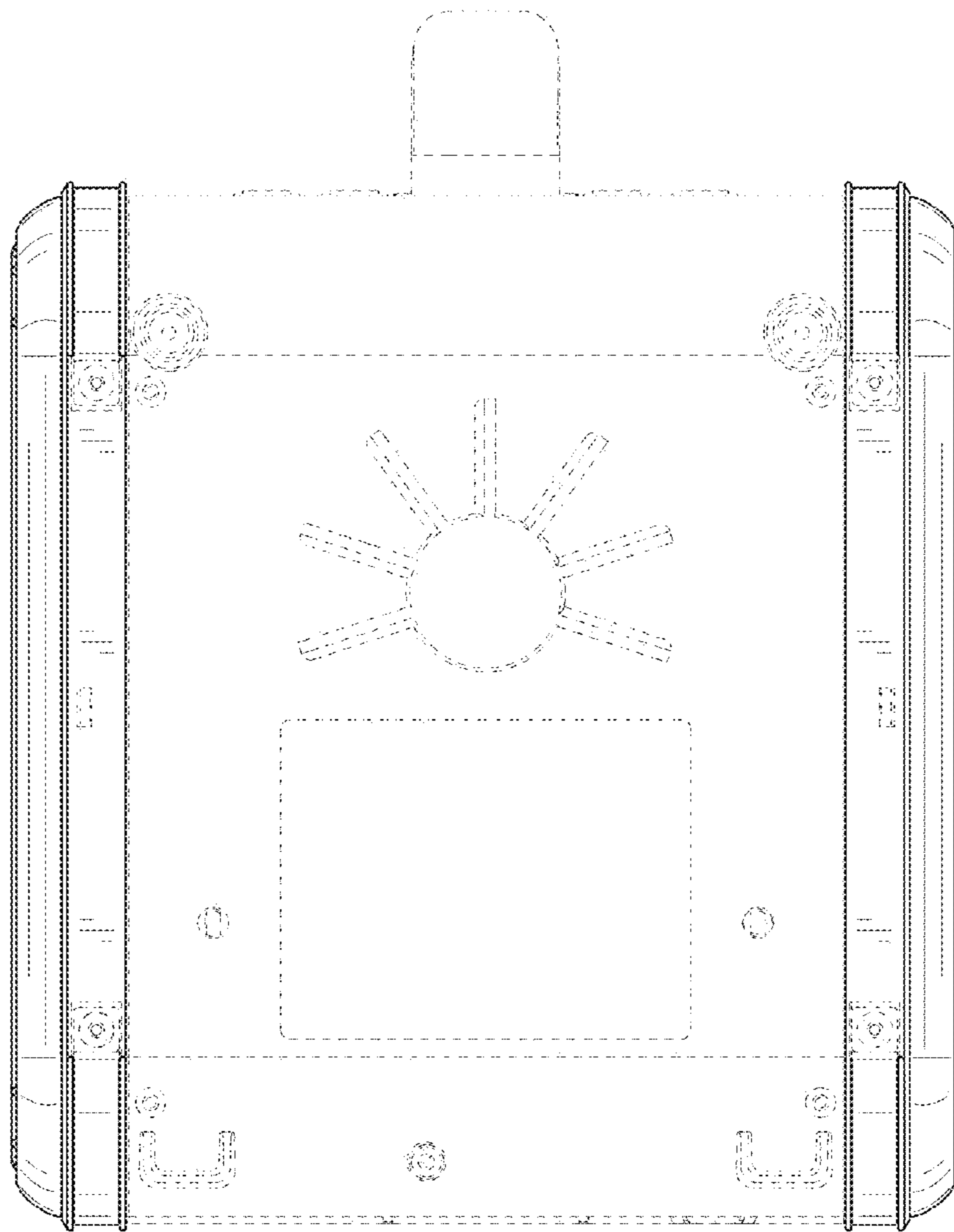

FIG. 7

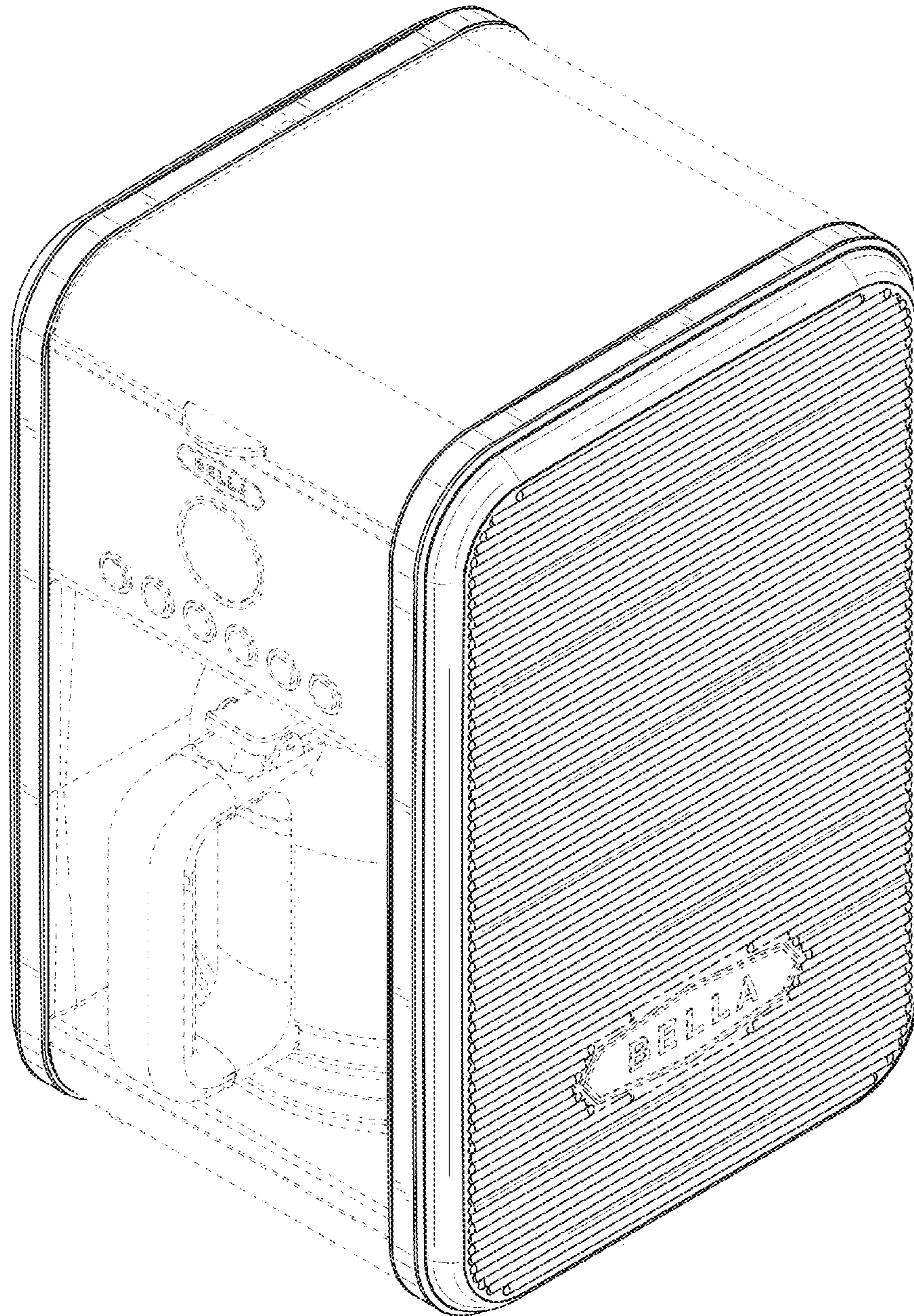

FIG. 8

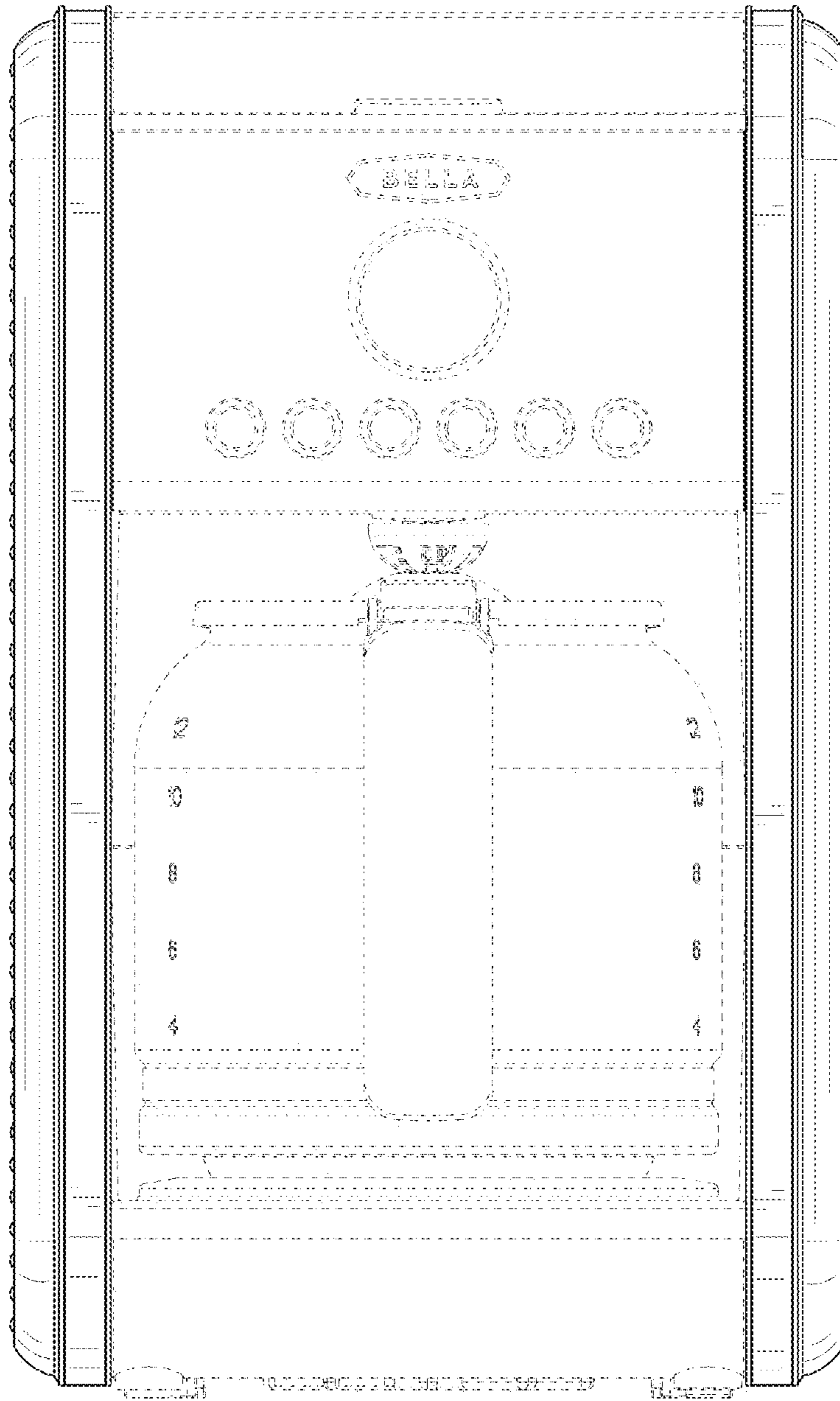

FIG. 9

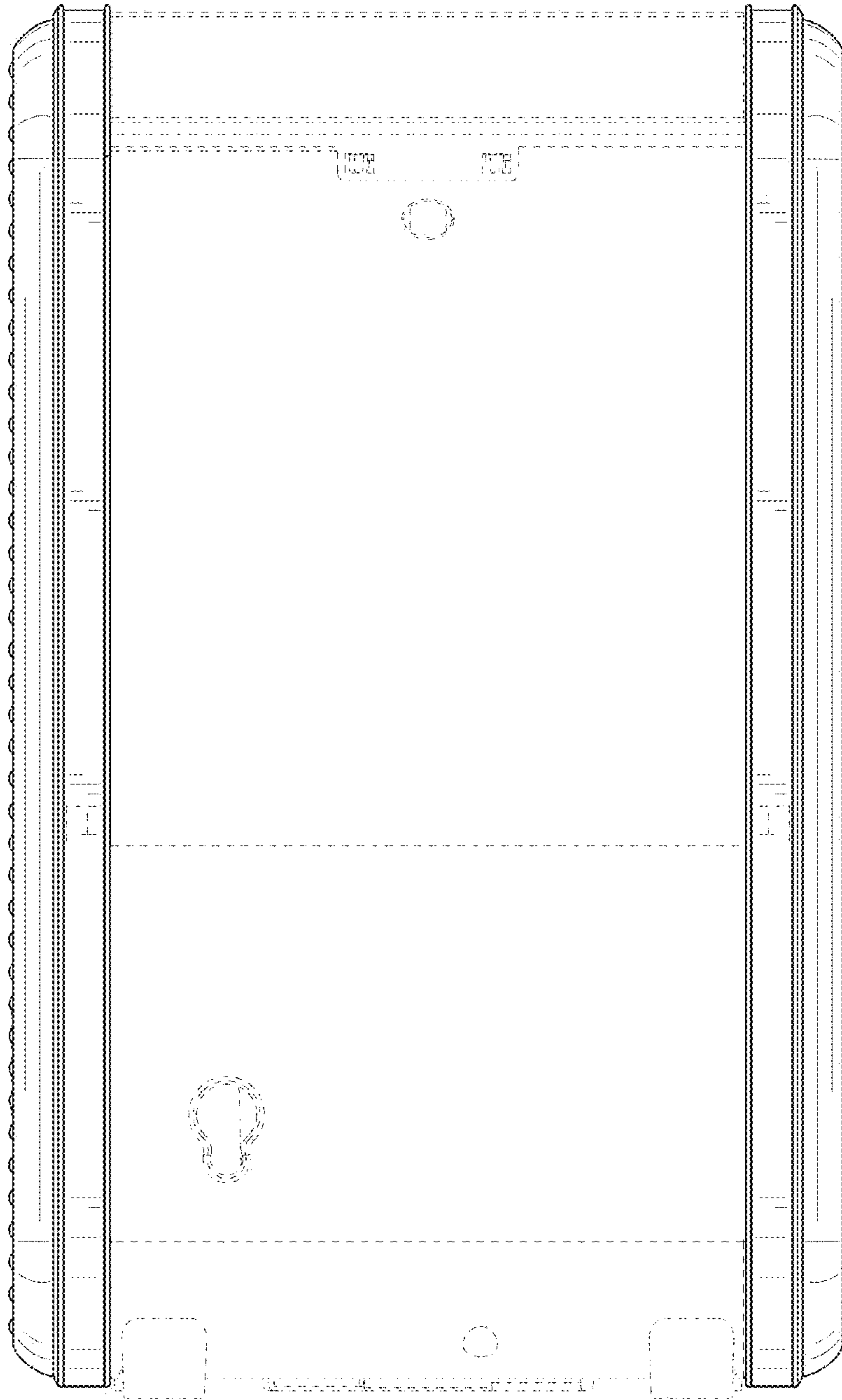

FIG. 10

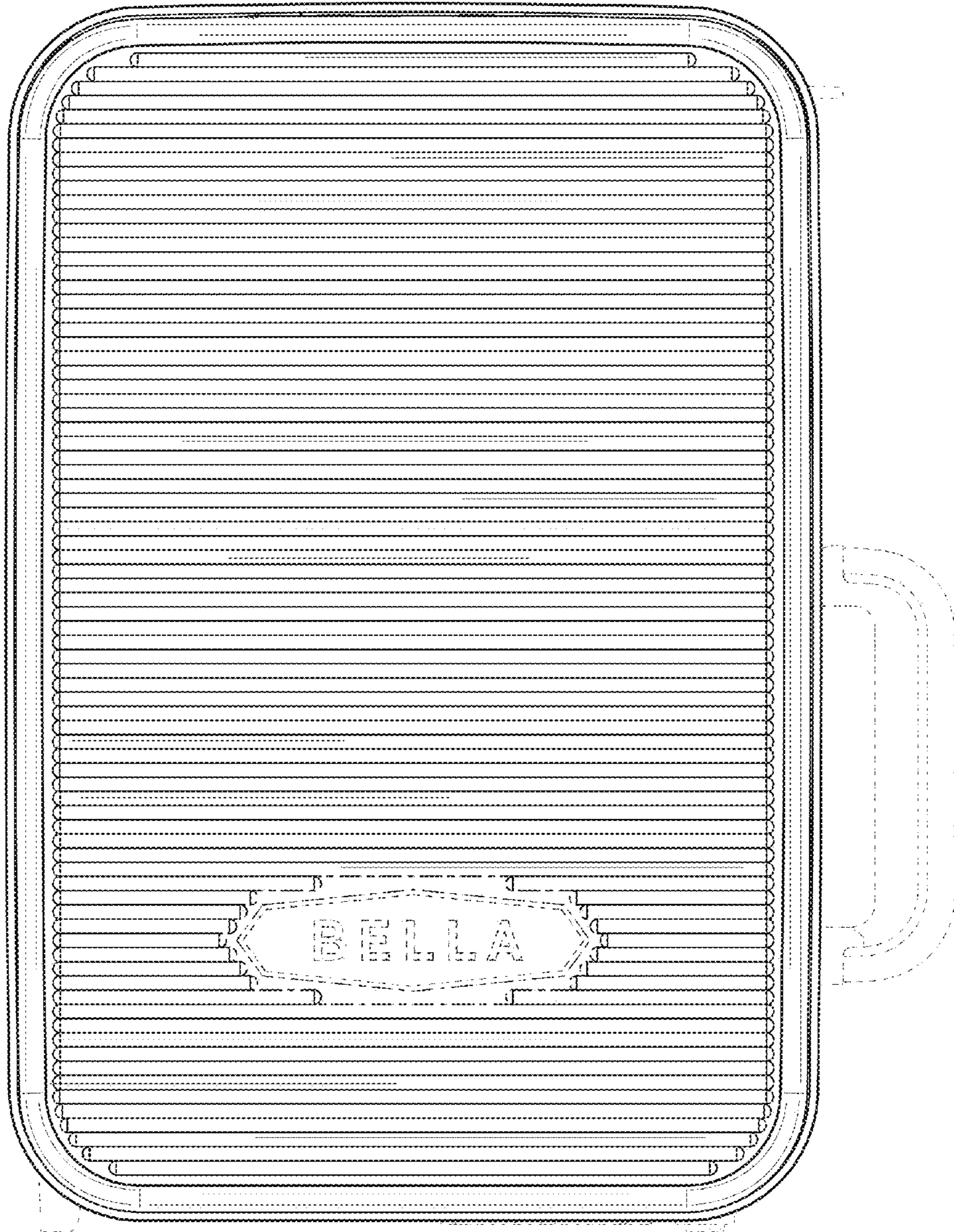

FIG. 11

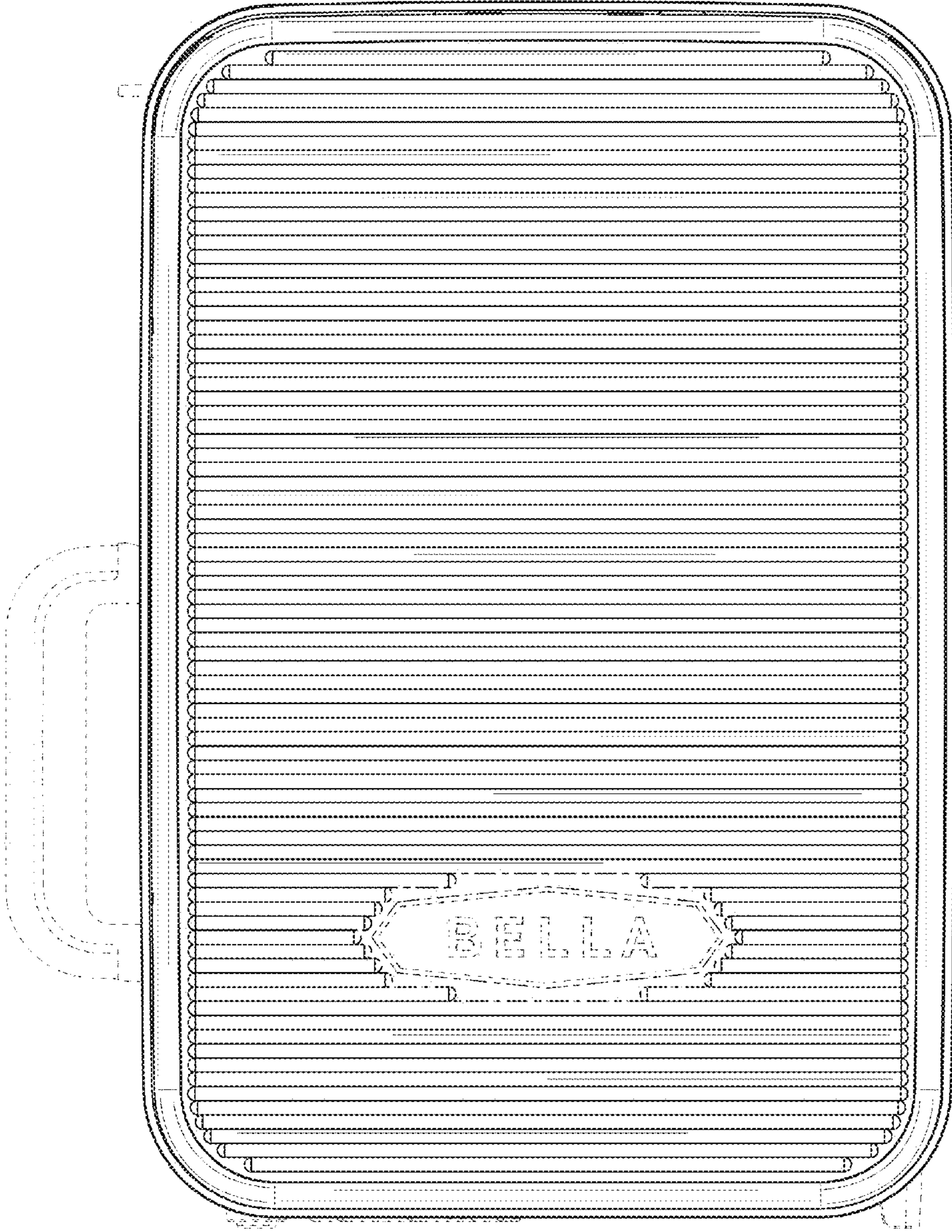

FIG. 12

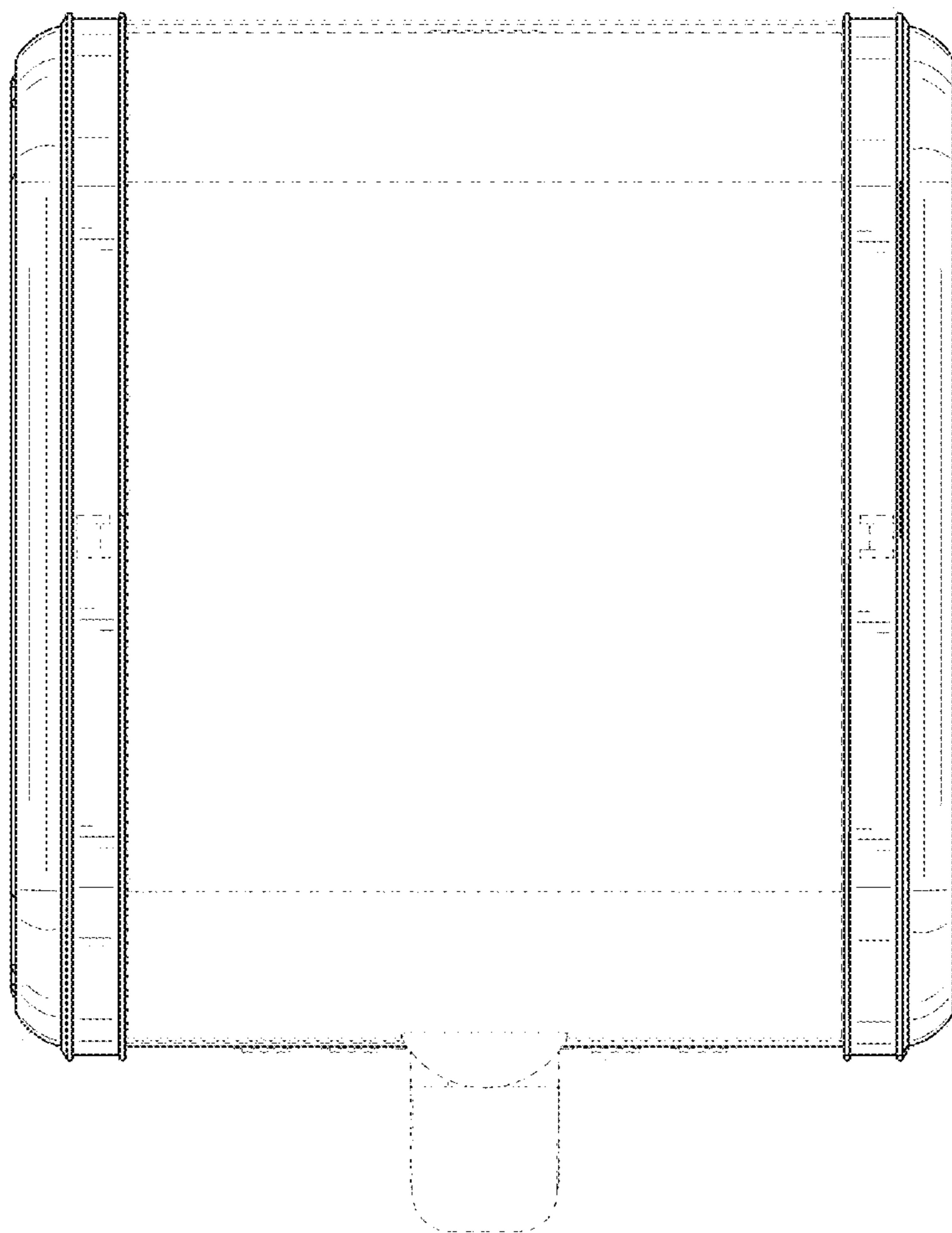

FIG. 13

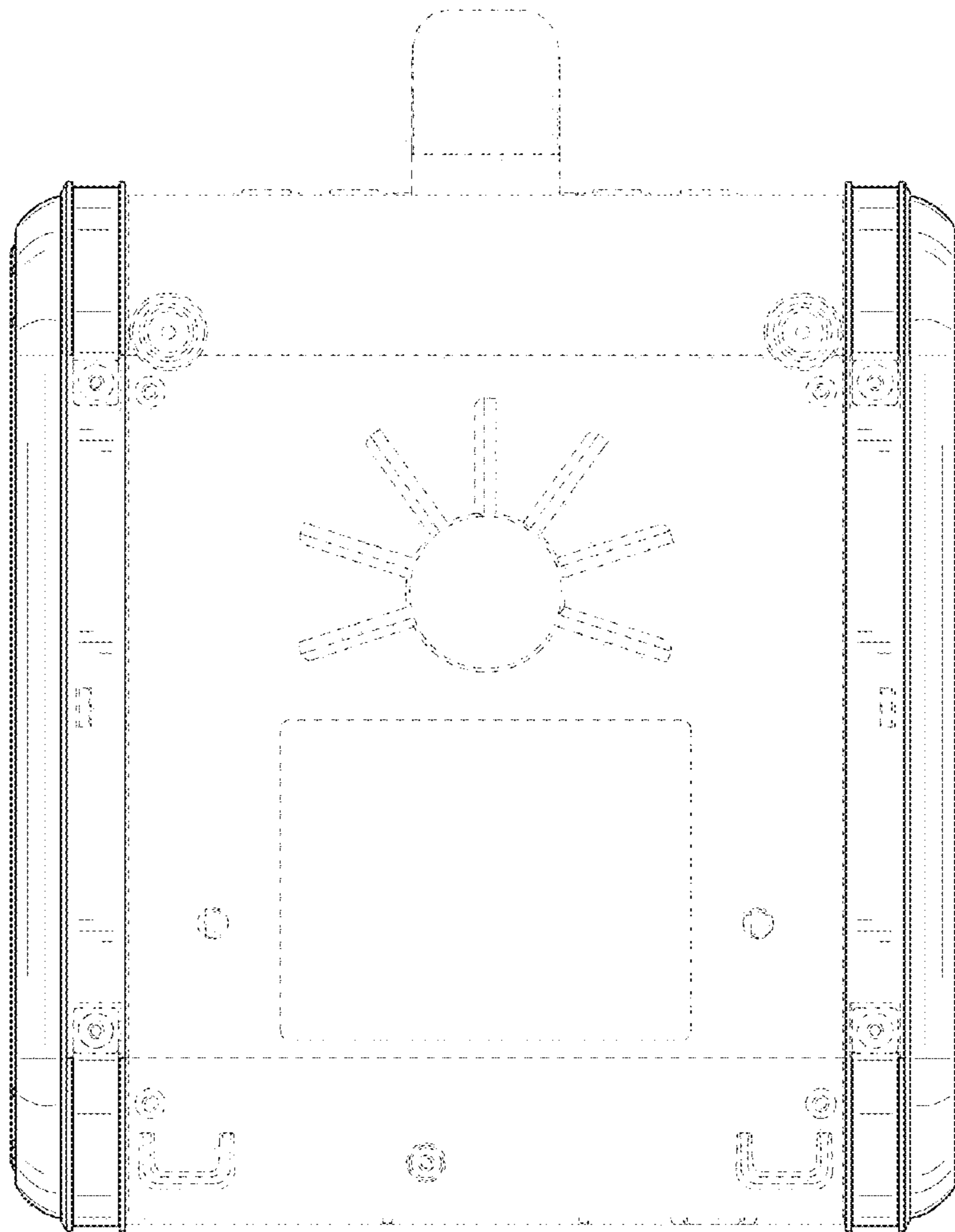

FIG. 14