



US00D750408S

(12) **United States Design Patent**
Cha et al.

(10) **Patent No.:** **US D750,408 S**
(45) **Date of Patent:** **** Mar. 1, 2016**

(54) **BEVERAGE DISPENSER**
(71) Applicant: **The Coca-Cola Company**, Atlanta, GA (US)
(72) Inventors: **Jae Ho Cha**, Woodstock, GA (US); **Kris Tomasson**, Atlanta, GA (US); **David Harvey**, Suwanee, GA (US); **Daniel S. Quartarone**, Atlanta, GA (US); **Scott M. Harrison**, Atlanta, GA (US); **Simon Alan Daniel**, London (GB); **Christopher Michael Weston**, London (GB)

(73) Assignee: **The Coca-Cola Company**, Atlanta, GA (US)

(**) Term: **14 Years**

(21) Appl. No.: **29/489,824**

(22) Filed: **May 2, 2014**

(51) **LOC (10) Cl.** **07-01**

(52) **U.S. Cl.**
USPC **D7/306**

(58) **Field of Classification Search**
USPC D7/306-311, 305, 300, 313, 399, 398, D7/397; 99/279, 284, 290, 280, 299, 307, 99/305, 295, 308, 309, 323.1; 222/23, 222/129.1; 62/395; D20/1; D23/207, 209
CPC A47J 31/44; A47J 31/00; B67D 1/0041; B67D 3/00
See application file for complete search history.

(56) **References Cited**

U.S. PATENT DOCUMENTS

D418,000 S * 12/1999 Mork et al. D7/309
D437,173 S * 2/2001 Naft et al. D7/309
D453,655 S * 2/2002 Powell et al. D7/306
D481,580 S * 11/2003 Daniels et al. D7/309
D514,371 S * 2/2006 Yang et al. D7/309

D529,752 S * 10/2006 Sumser et al. D7/309
D556,496 S * 12/2007 Fung D7/309
D608,129 S * 1/2010 Spear et al. D7/306
D623,000 S * 9/2010 Murauyou et al. D7/309
D709,722 S * 7/2014 Luippold et al. D7/306
8,776,671 B2 * 7/2014 Van Os et al. 99/286
D710,643 S * 8/2014 Broen et al. D7/306
D716,093 S * 10/2014 Jakeman et al. D7/306

* cited by examiner

Primary Examiner — Marianne Pandozzi
(74) *Attorney, Agent, or Firm* — McAndrews Held & Malloy, Ltd.

(57) **CLAIM**
The ornamental design for a beverage dispenser, as shown and described.

DESCRIPTION

FIG. 1 is a left perspective view of a first embodiment of a beverage dispenser showing our new design;
FIG. 2 is a right perspective view thereof;
FIG. 3 is a front elevation view thereof;
FIG. 4 is a rear elevation view thereof;
FIG. 5 is a left-side elevation view thereof;
FIG. 6 is a right-side elevation view thereof;
FIG. 7 is a top plan view thereof;
FIG. 8 is a bottom plan view thereof;
FIG. 9 is a left perspective view of a second embodiment of a beverage dispenser showing our new design;
FIG. 10 is a right perspective view thereof;
FIG. 11 is a front elevation view thereof;
FIG. 12 is a rear elevation view thereof;
FIG. 13 is a left-side elevation view thereof;
FIG. 14 is a right-side elevation view thereof;
FIG. 15 is a top plan view thereof; and,
FIG. 16 is a bottom plan view thereof.
The broken lines are for environmental purposes only and form no part of the claimed design.

1 Claim, 16 Drawing Sheets

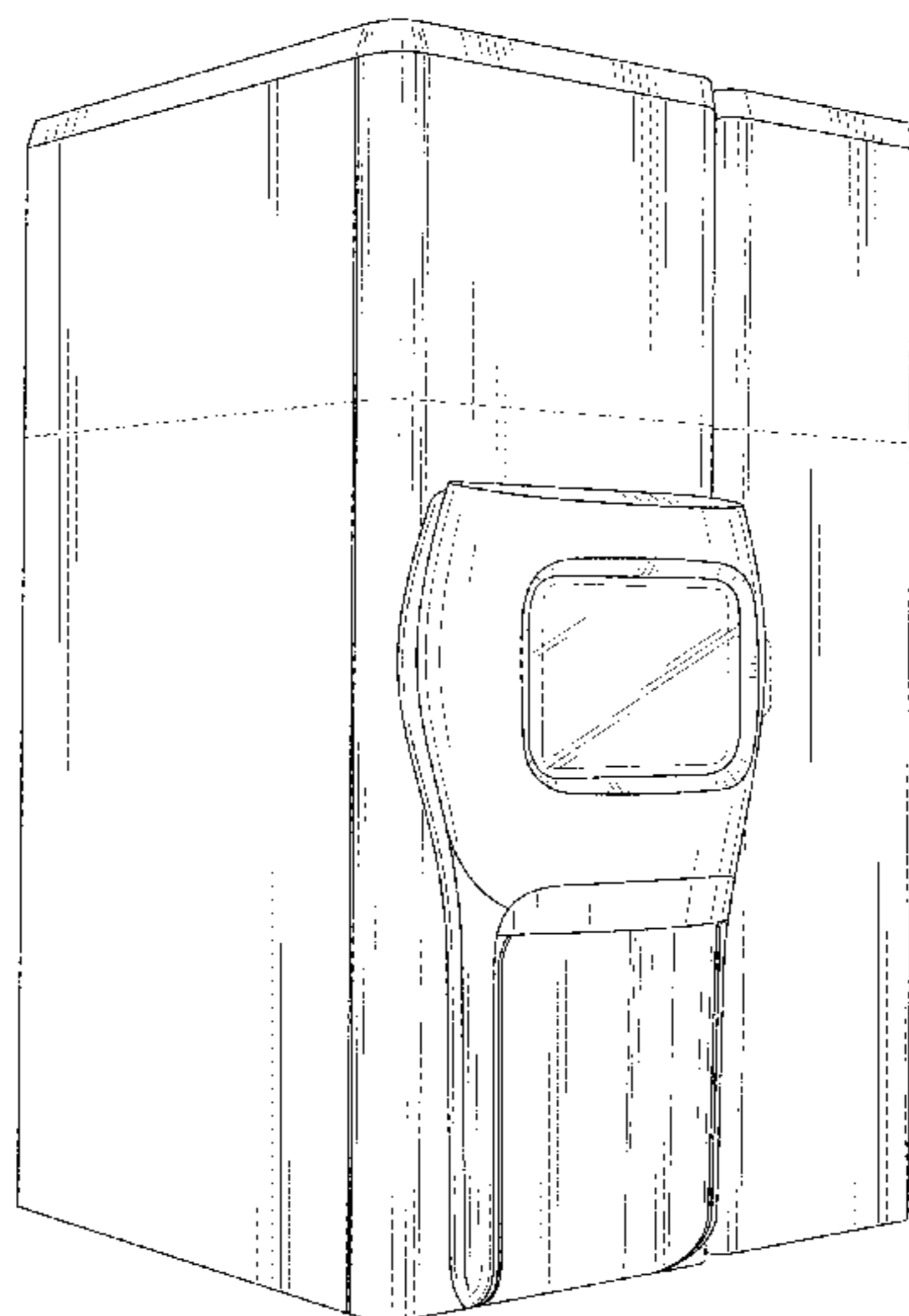

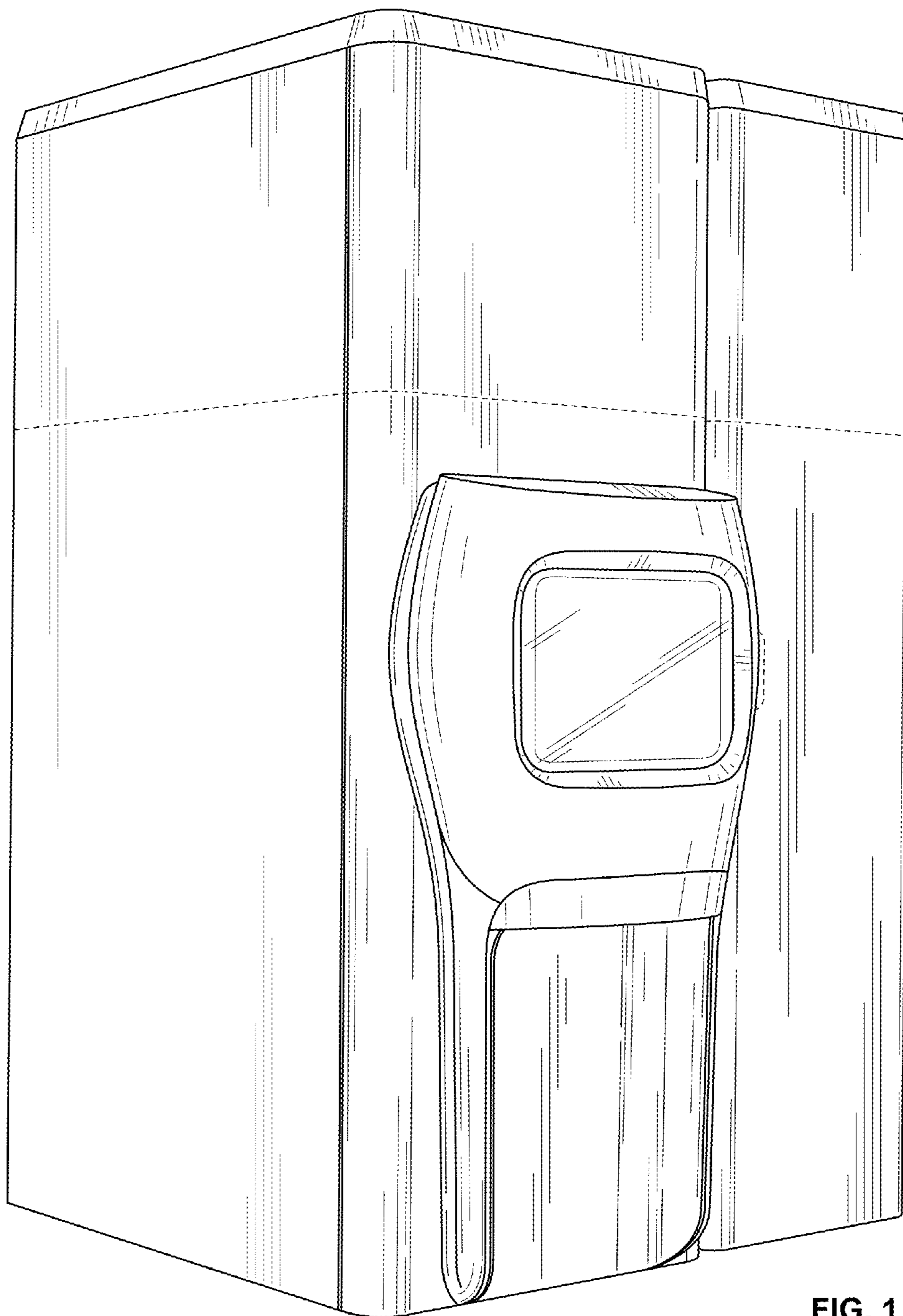

FIG. 1

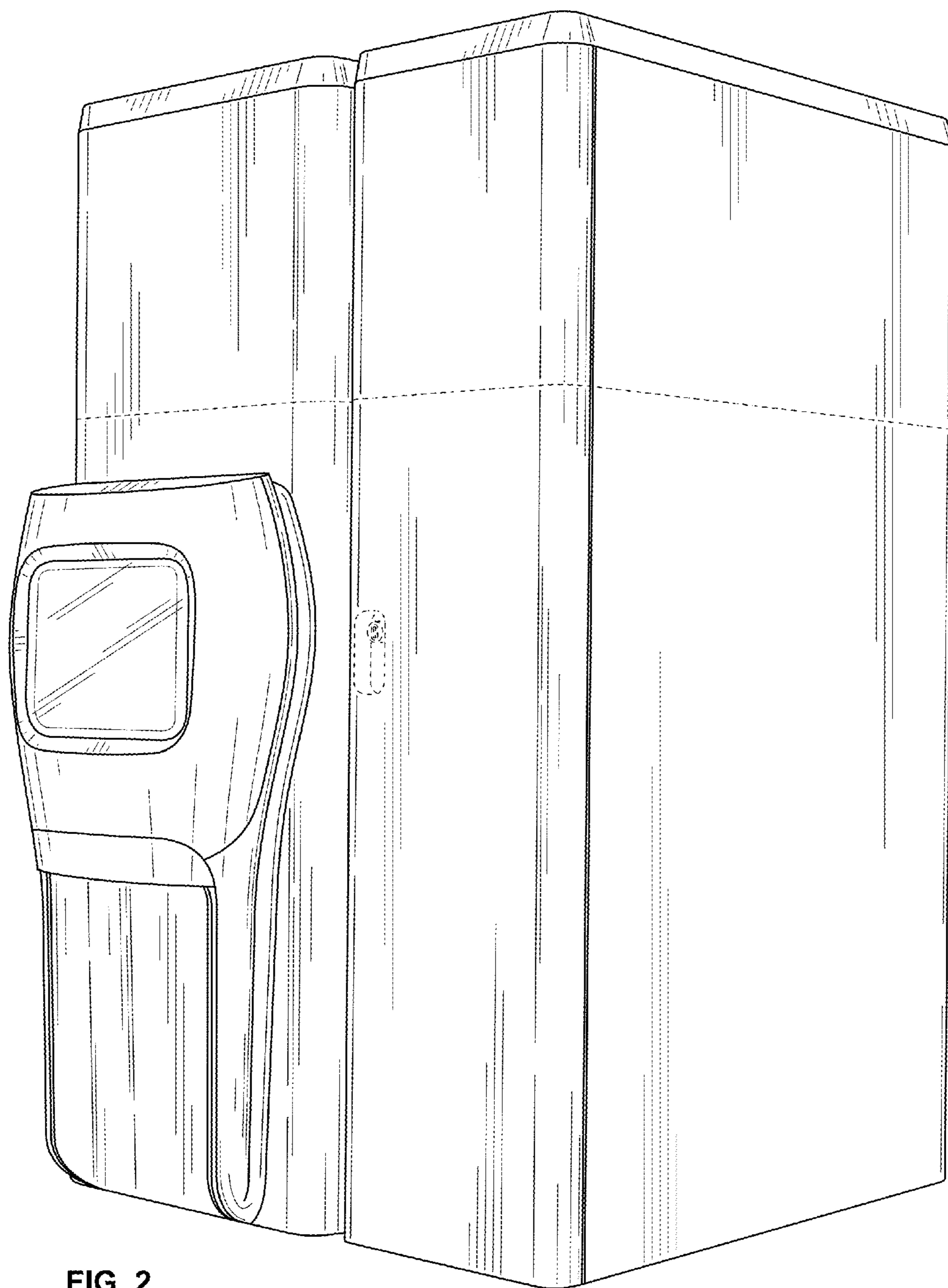

FIG. 2

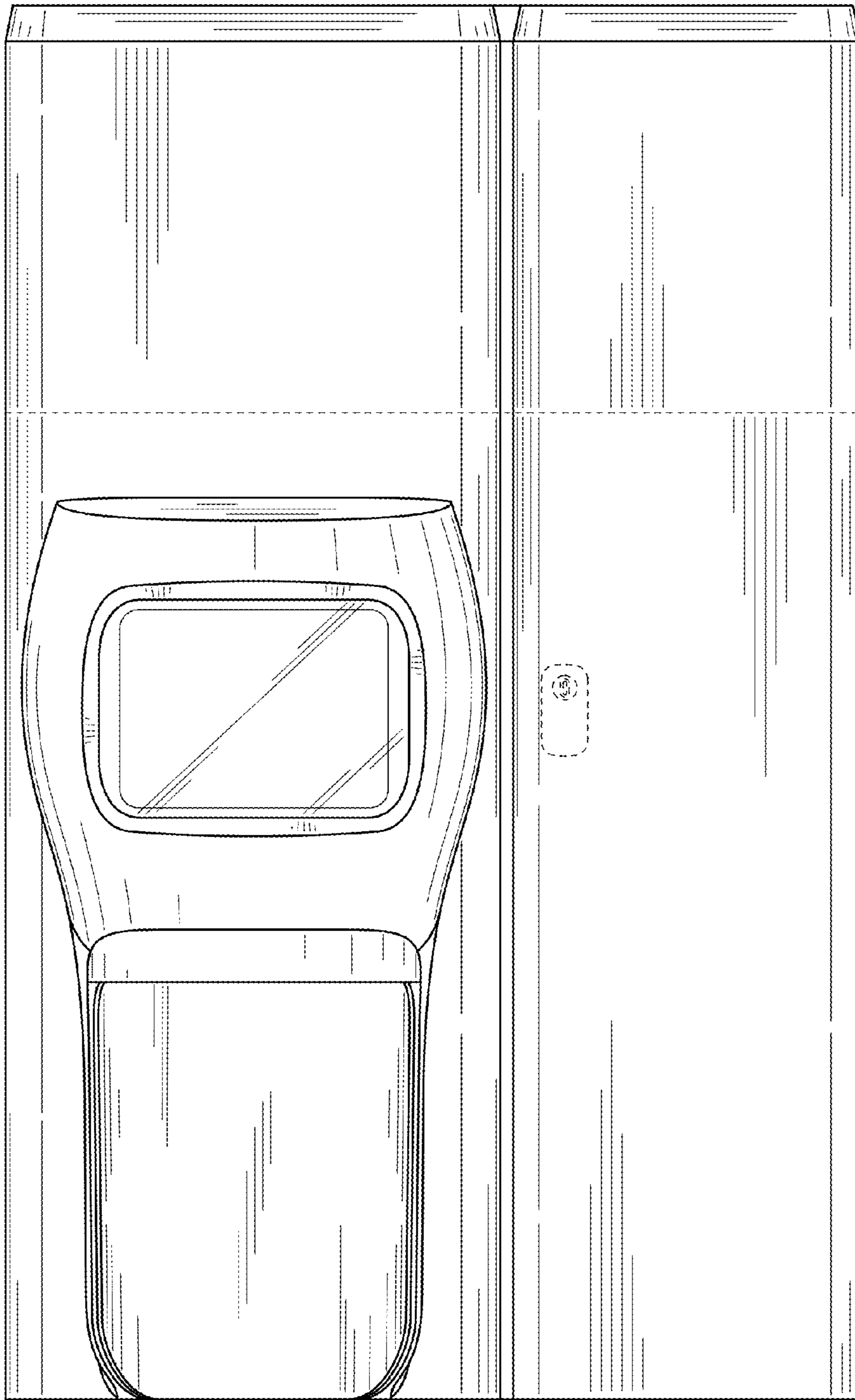

FIG. 3

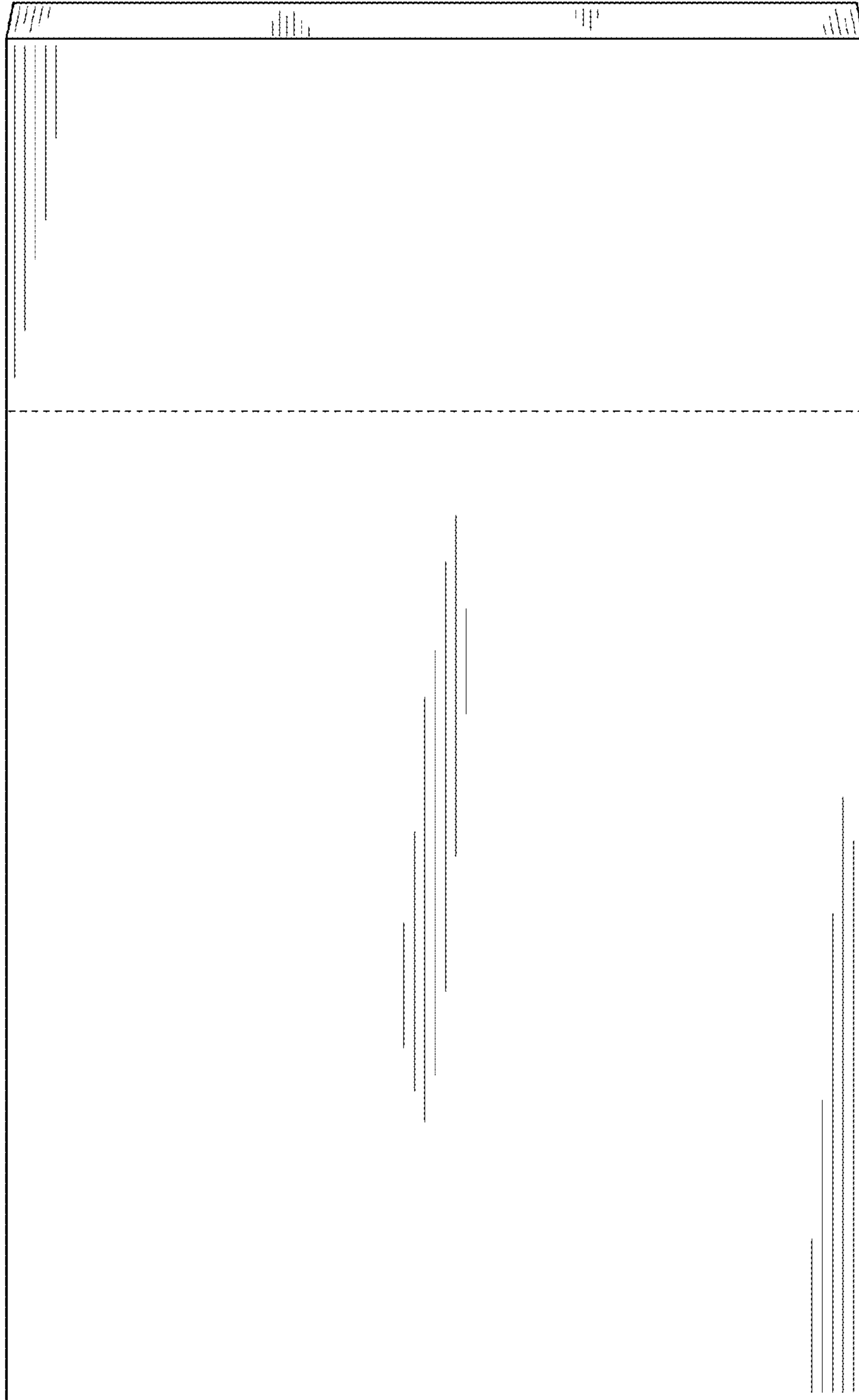

FIG. 4



FIG. 5

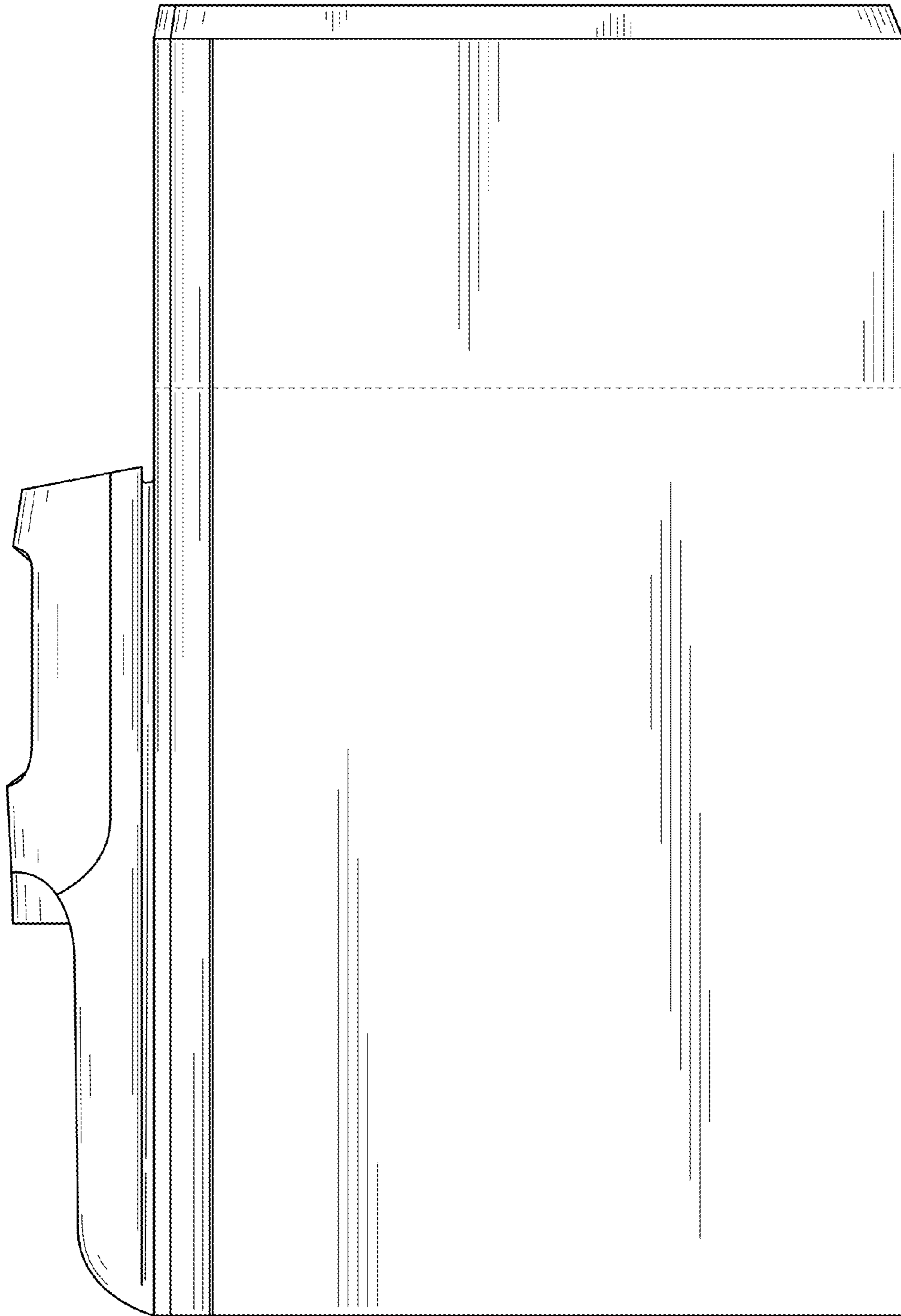

FIG. 6

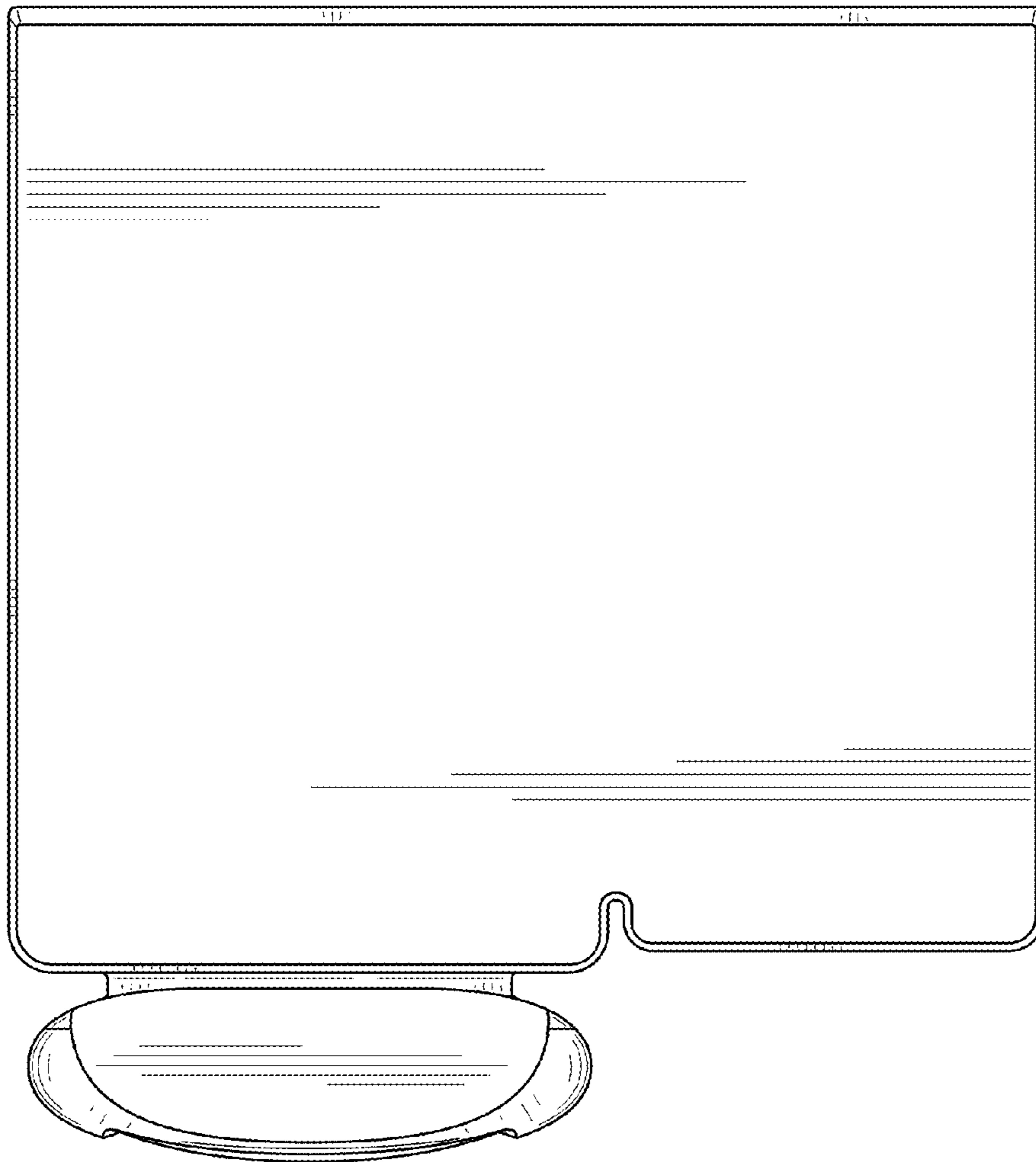

FIG. 7

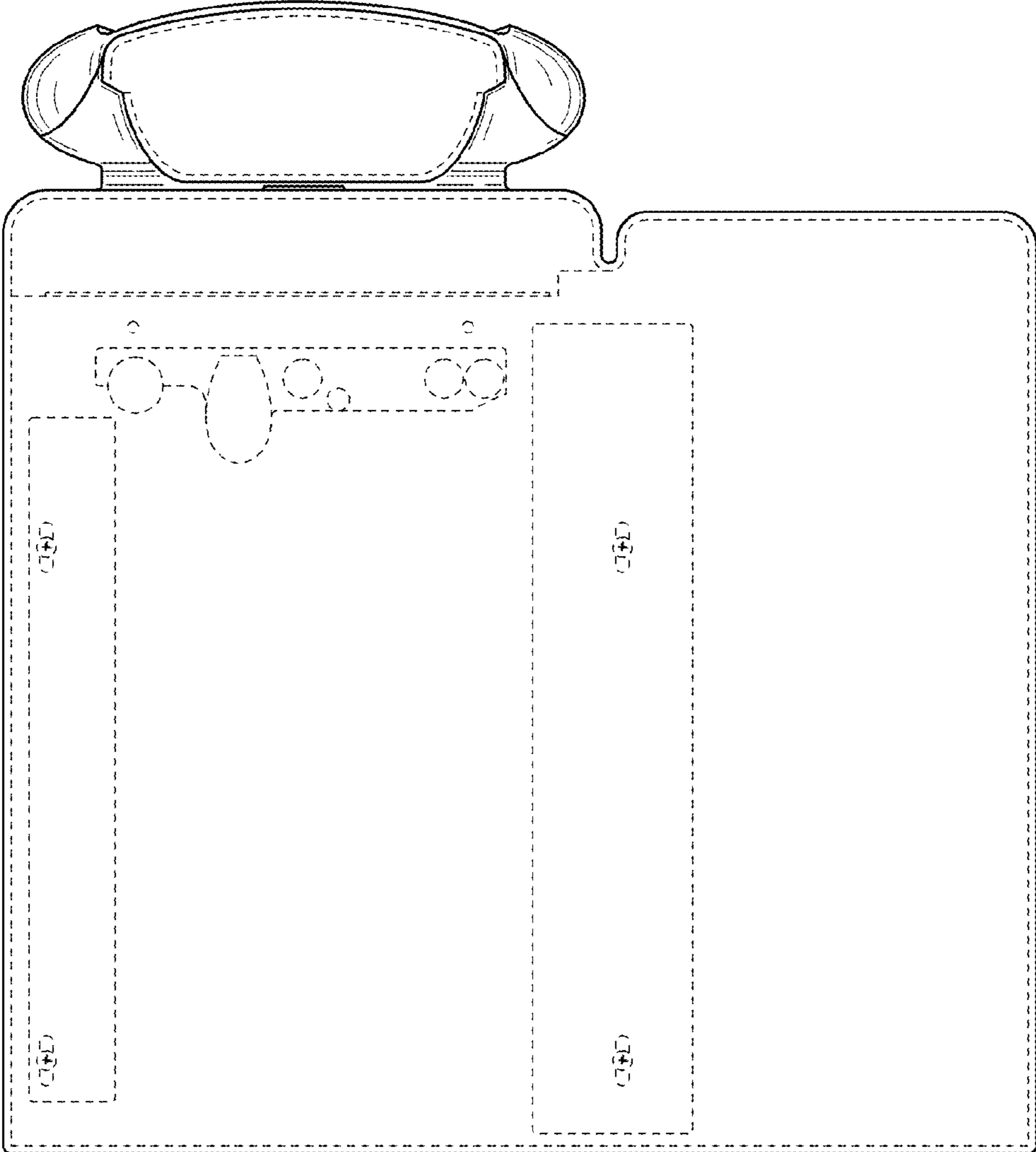

FIG. 8

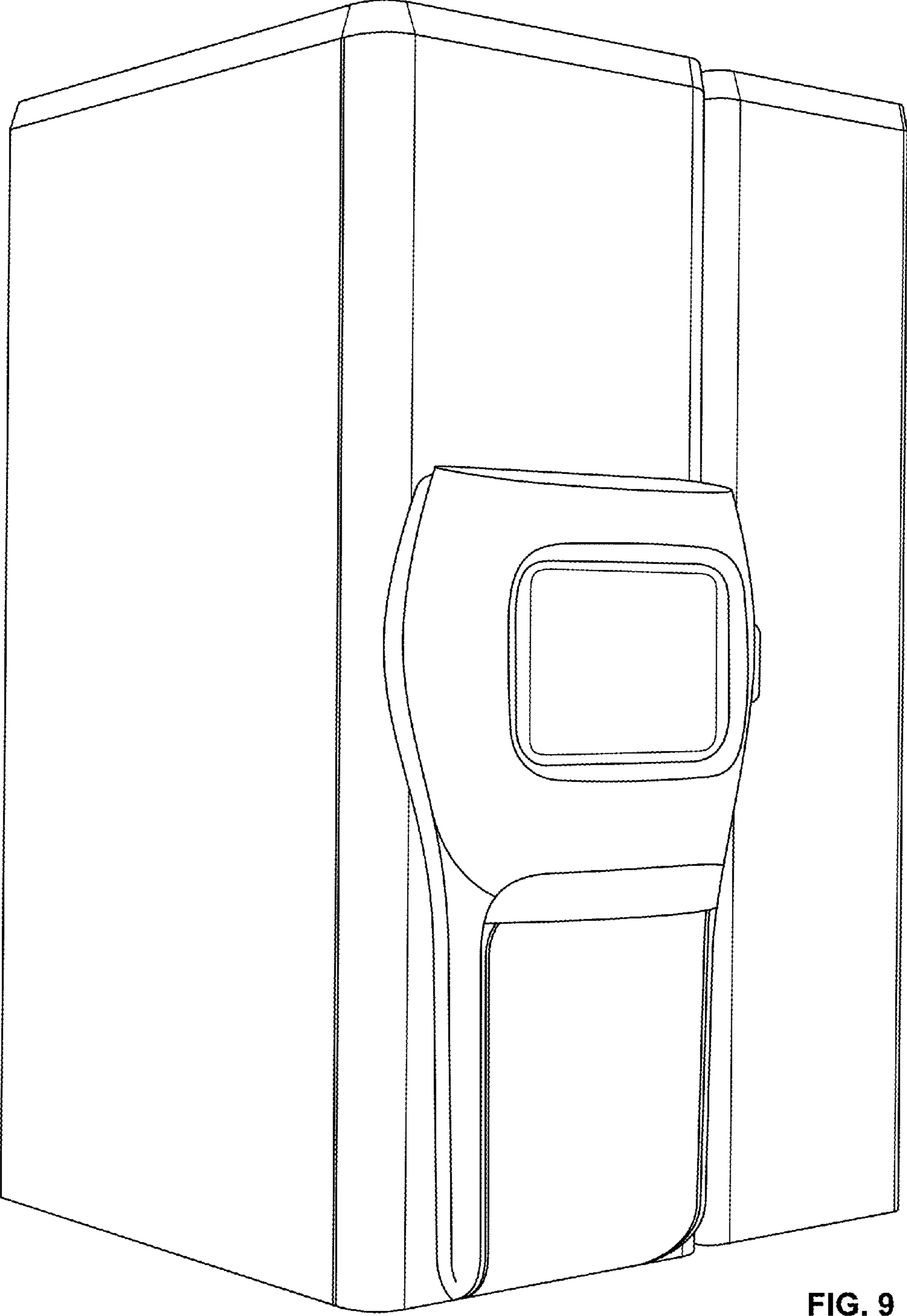

FIG. 9



FIG. 10

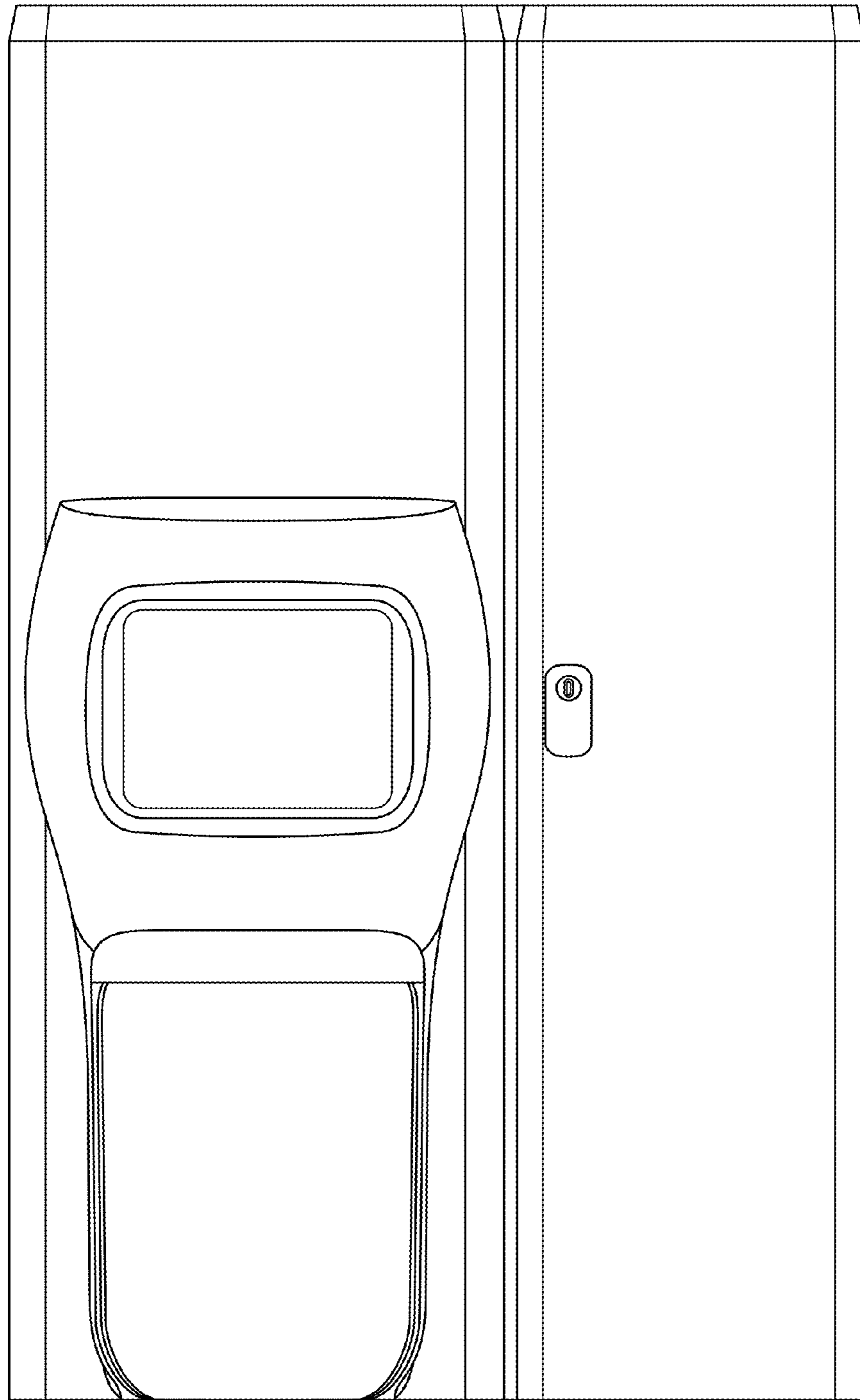

FIG. 11

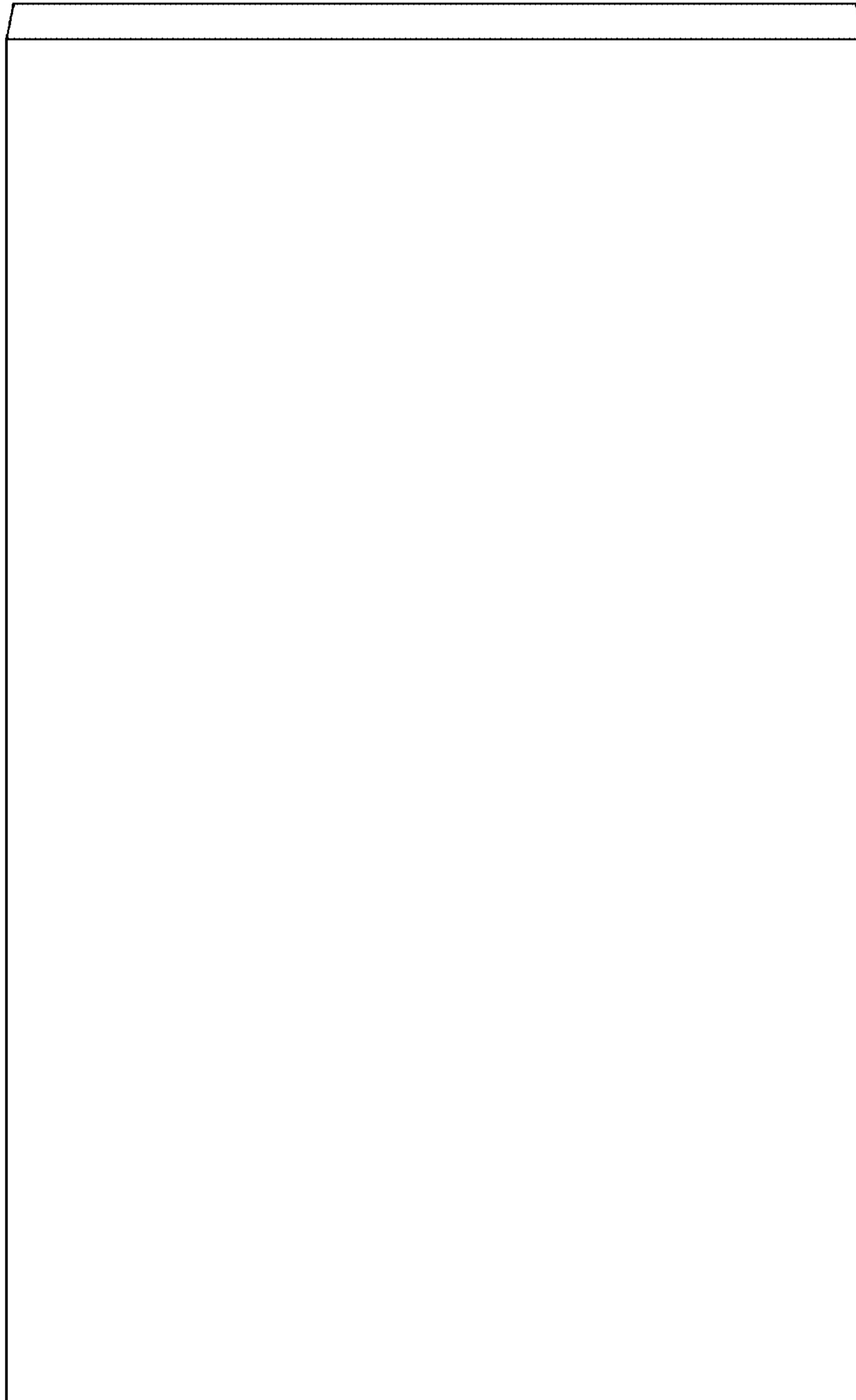

FIG. 12

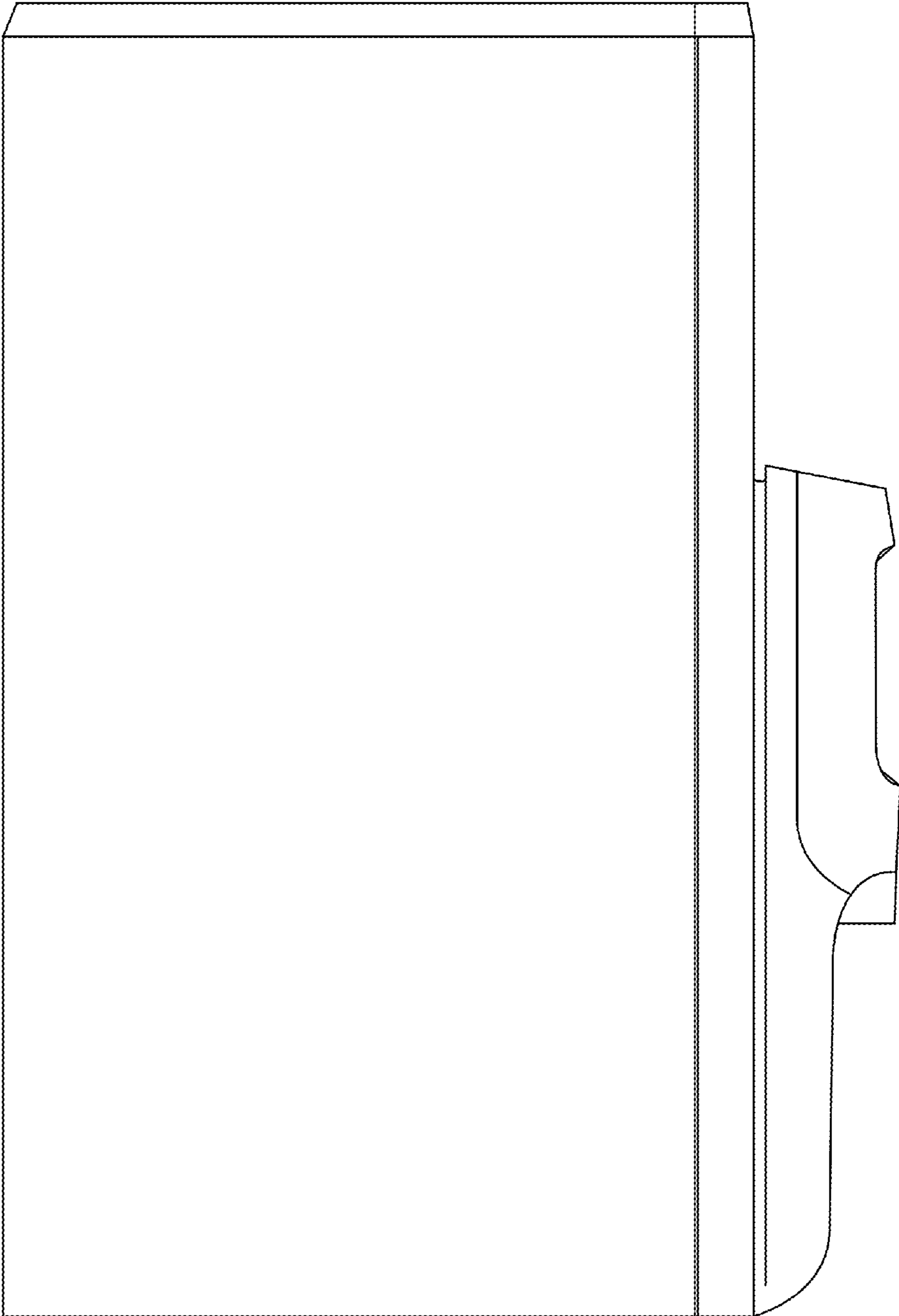

FIG. 13

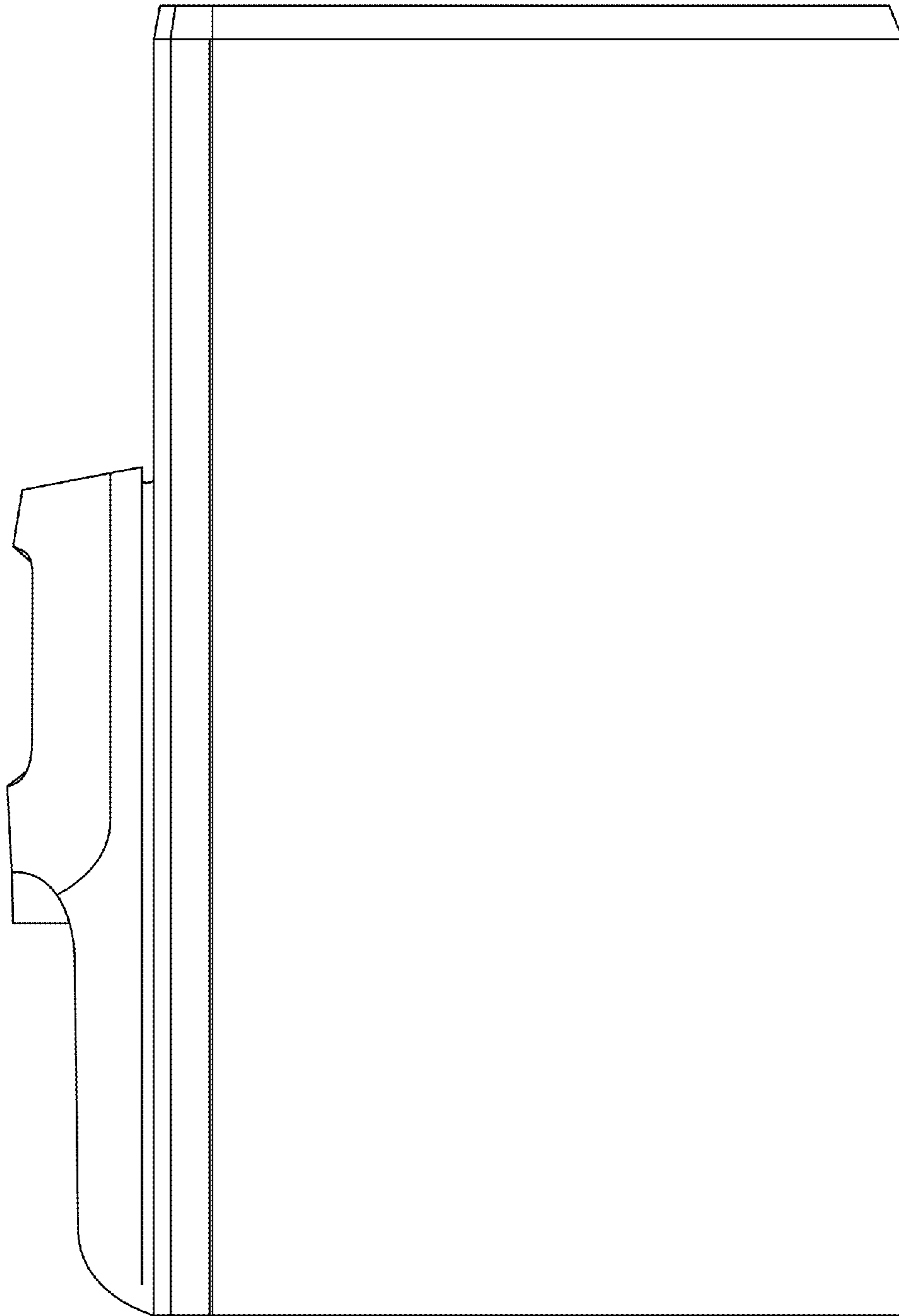

FIG. 14

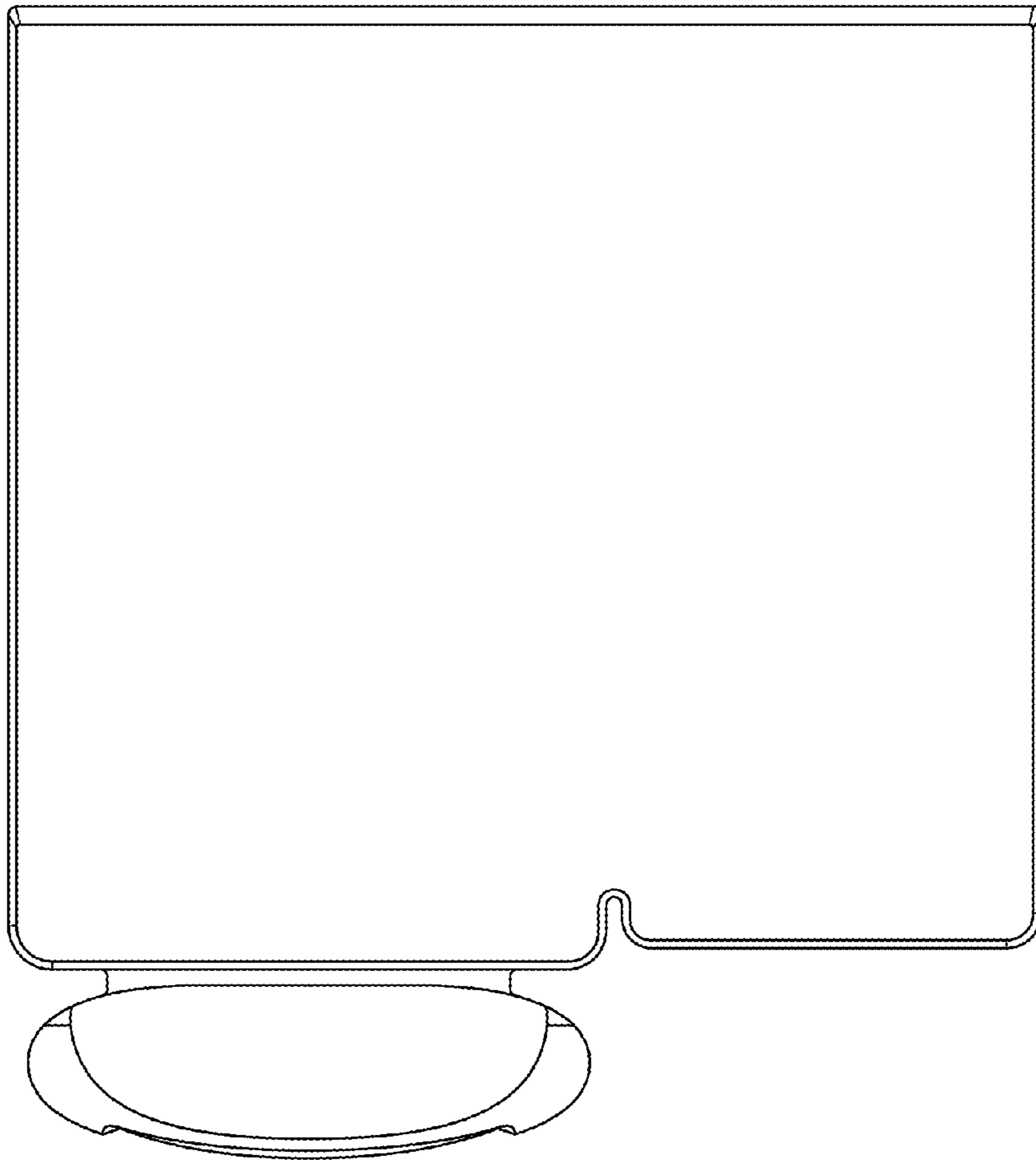

FIG. 15

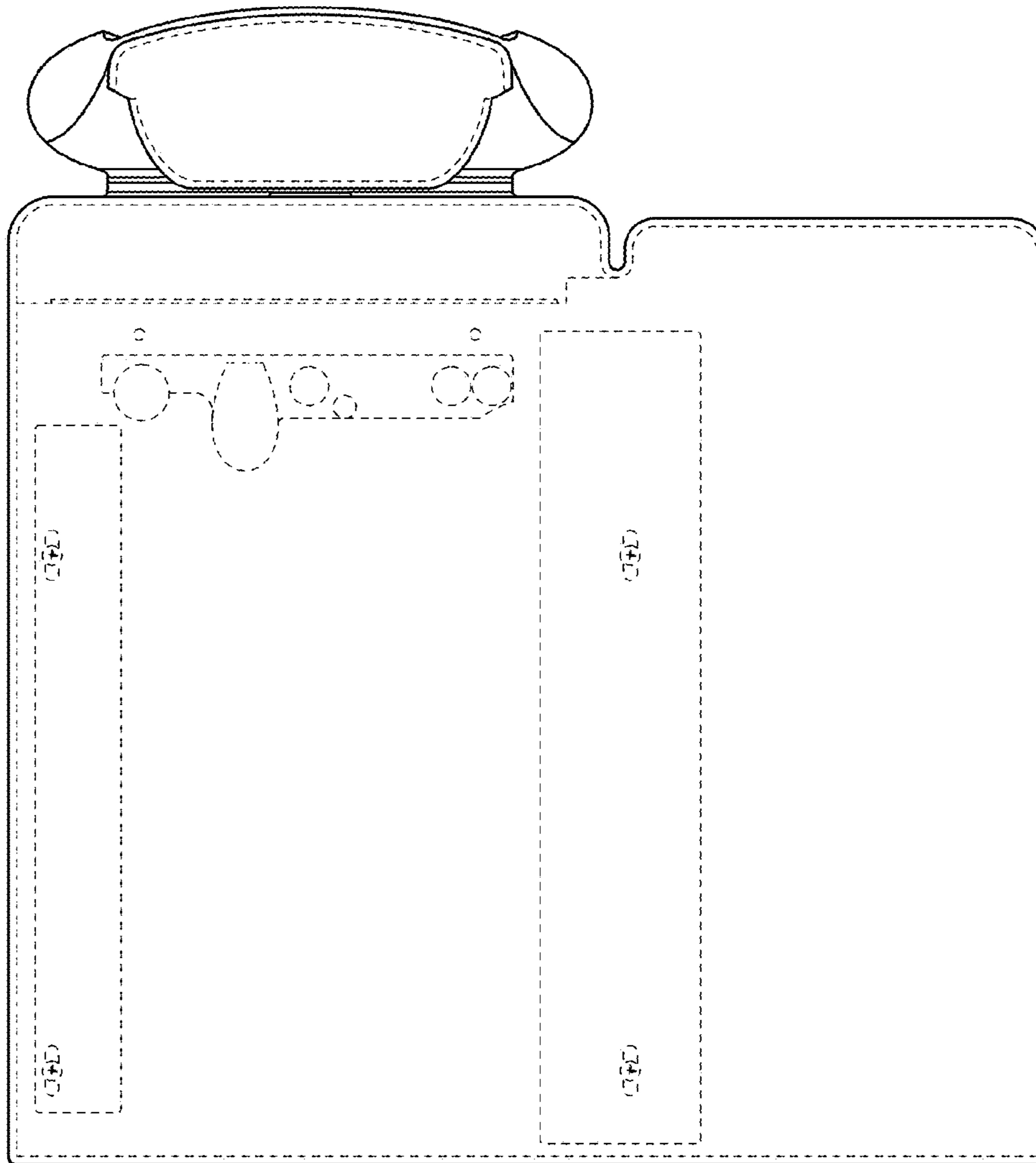

FIG. 16