



US00D750329S

(12) **United States Design Patent**
Leahy et al.

(10) **Patent No.:** **US D750,329 S**
(45) **Date of Patent:** **** Feb. 23, 2016**

(54) **HEADWEAR**

(71) Applicant: **DAQRI, LLC**, Los Angeles, CA (US)
(72) Inventors: **Timotheos Leahy**, Los Angeles, CA (US); **Brian Mullins**, Sierra Madre, CA (US); **Matthew Kammerait**, West Hollywood, CA (US)

(73) Assignee: **DAQRI, LLC**, Los Angeles, CA (US)

(**) Term: **14 Years**

(21) Appl. No.: **29/523,291**

(22) Filed: **Apr. 8, 2015**

(51) **LOC (10) Cl.** **29-02**

(52) **U.S. Cl.**
USPC **D29/109**

(58) **Field of Classification Search**
USPC D29/100, 102, 104, 105, 106, 107, 108, D29/109, 110, 122
CPC A42B 3/18; A42B 3/185; A42B 3/20; A42B 3/22; A42B 3/221; A42B 3/222; A42B 3/223; A42B 3/225; A42B 3/226; A42B 3/227; A42B 3/228; A42B 3/042; A61F 9/02; A61F 9/021; A61F 9/022; A61F 9/023; A61F 9/026; A61F 9/027; A61F 9/04; A61F 9/045; A61F 9/06; A61F 9/061; A61F 9/062; A61F 9/064; A61F 9/065; A61F 9/067; A63B 33/002; A41D 13/11

See application file for complete search history.

D375,317 S *	11/1996	Canavan	D16/101
D380,872 S *	7/1997	Wickland	D29/109
D382,672 S *	8/1997	Bourque	D29/110
D404,848 S *	1/1999	Banuchi	D29/110
D404,849 S *	1/1999	Desy	D29/110
D428,620 S *	7/2000	Maturaporn	2/12
D454,667 S *	3/2002	Chartrand	D29/110
D458,713 S *	6/2002	Cheng	D29/110
D481,173 S *	10/2003	Alexander	D29/110
D534,568 S *	1/2007	Canavan	D16/314
D539,485 S *	3/2007	Huh	D29/110
D541,991 S *	5/2007	Lawrence	D29/110
D569,557 S *	5/2008	Cho	D29/122
D574,558 S *	8/2008	Morency	D29/122
D602,977 S *	10/2009	Falvo	D16/315
D614,359 S *	4/2010	Gleason	D16/314
D627,108 S *	11/2010	Blauer	D29/110
D681,283 S *	4/2013	Wang Lee	D29/110
D700,401 S *	2/2014	Larrivee	D29/110
D726,378 S *	4/2015	Wako	D29/110
2006/0206995 A1 *	9/2006	Hong	A42B 3/226 2/424

* cited by examiner

Primary Examiner — Elizabeth J Oswecki

(74) *Attorney, Agent, or Firm* — Schwegman Lundberg & Woessner, P.A.

(57) **CLAIM**

The ornamental design for headwear, as shown and described.

(56) **References Cited**

U.S. PATENT DOCUMENTS

2,388,626 A *	11/1945	Wilson	G02C 7/16 2/13
D157,083 S *	1/1950	Paulson	D29/110
2,743,448 A *	5/1956	Carlson	A63H 33/00 2/438
D254,638 S *	4/1980	Bay, Jr.	D29/109
4,393,519 A *	7/1983	Nicastro	A42C 5/02 2/12
D274,918 S *	7/1984	Trice, Jr.	D19/59
D320,289 S *	9/1991	Blackstone	D16/312
D324,745 S *	3/1992	Flores	D16/312
D361,868 S *	8/1995	Raugh	D29/109
D373,223 S *	8/1996	Pernicka	D29/110

DESCRIPTION

FIG. 1 is a top, front, left perspective view of headwear showing our new design;
FIG. 2 is another top, front, left perspective view thereof, with the transparent outer visor removed to show the transparent inner visor for ease of illustration;
FIG. 3 is another top, front, left perspective view thereof, with the transparent inner visor removed to show the transparent outer visor for ease of illustration;
FIG. 4 is a front elevation view thereof;
FIG. 5 is another front elevation view thereof, with the transparent outer visor removed to show the transparent inner visor for ease of illustration.

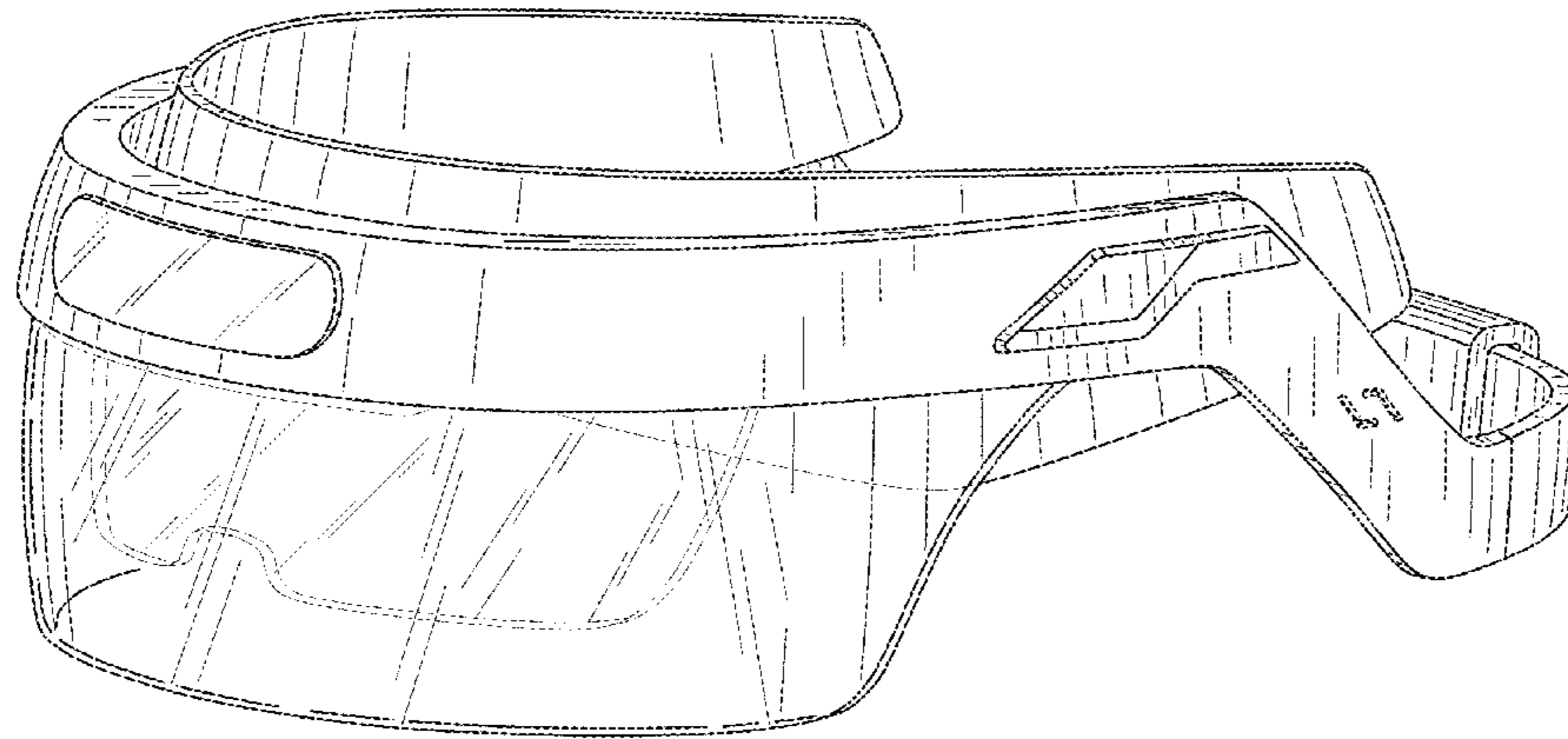

FIG. 6 is another front elevation view thereof, with the transparent inner visor removed to show the transparent outer visor for ease of illustration;

FIG. 7 is a left side elevation view thereof;

FIG. 8 is another left side elevation view thereof, with the transparent outer visor removed to show the transparent inner visor for ease of illustration;

FIG. 9 is another left side elevation view thereof, with the transparent inner visor removed to show the transparent outer visor for ease of illustration;

FIG. 10 is a rear elevation view thereof;

FIG. 11 is another rear elevation view thereof, with the transparent outer visor removed to show the transparent inner visor for ease of illustration;

FIG. 12 is another rear elevation view thereof, with the transparent inner visor removed to show the transparent outer visor for ease of illustration;

FIG. 13 is a right side elevation view thereof;

FIG. 14 is another right side elevation view thereof, with the transparent outer visor removed to show the transparent inner visor for ease of illustration;

FIG. 15 is another right side elevation view thereof, with the transparent inner visor removed to show the transparent outer visor for ease of illustration;

FIG. 16 is a bottom plan view thereof;

FIG. 17 is another bottom plan view thereof, with the transparent outer visor removed to show the transparent inner visor for ease of illustration;

FIG. 18 is another bottom plan view thereof, with the transparent inner visor removed to show the transparent outer visor for ease of illustration; and,

FIG. 19 is a top plan view thereof.

The shade lines show contour and not surface ornamentation. Subject matter shown in broken lines is environmental and forms no part of the claimed design.

1 Claim, 19 Drawing Sheets

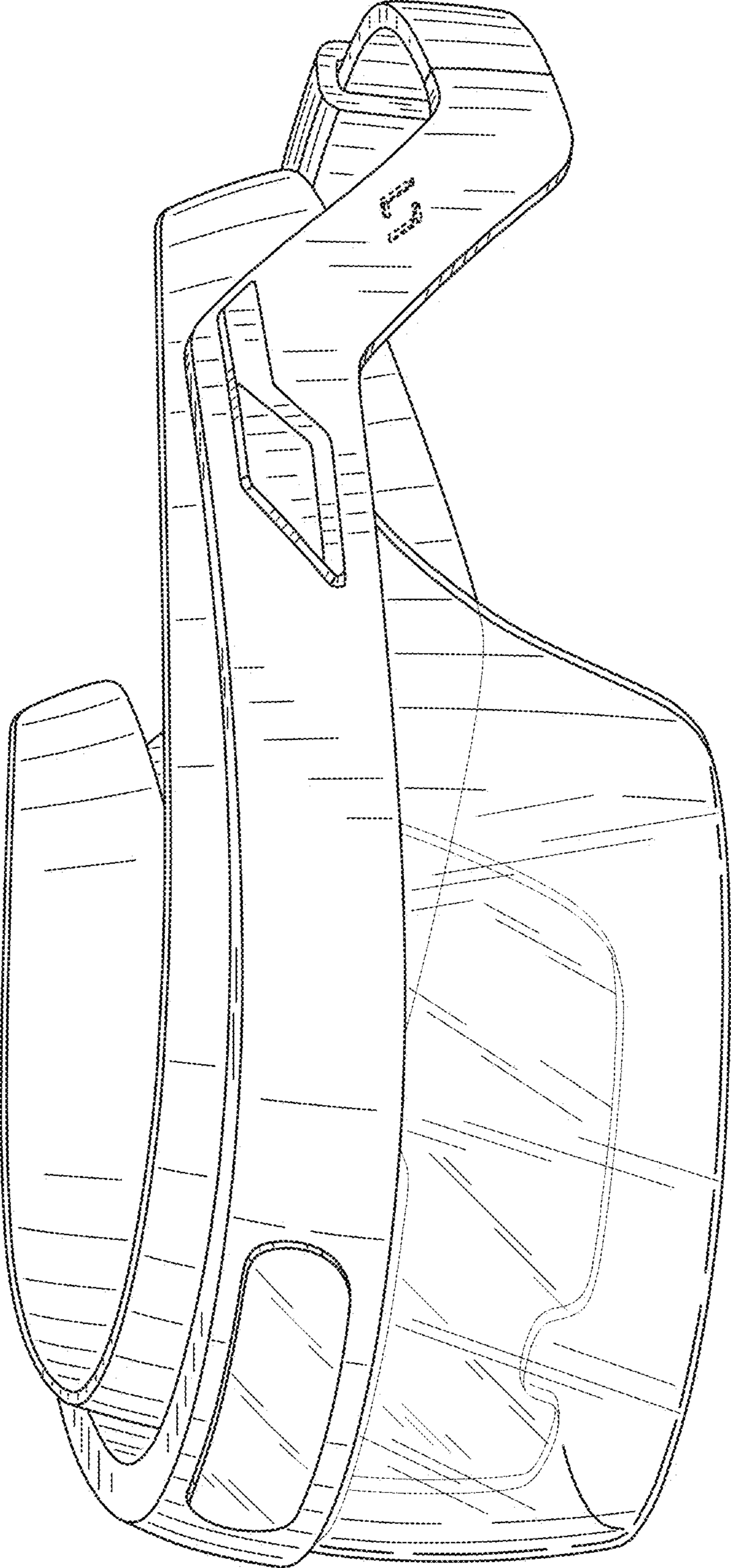

FIG. 1

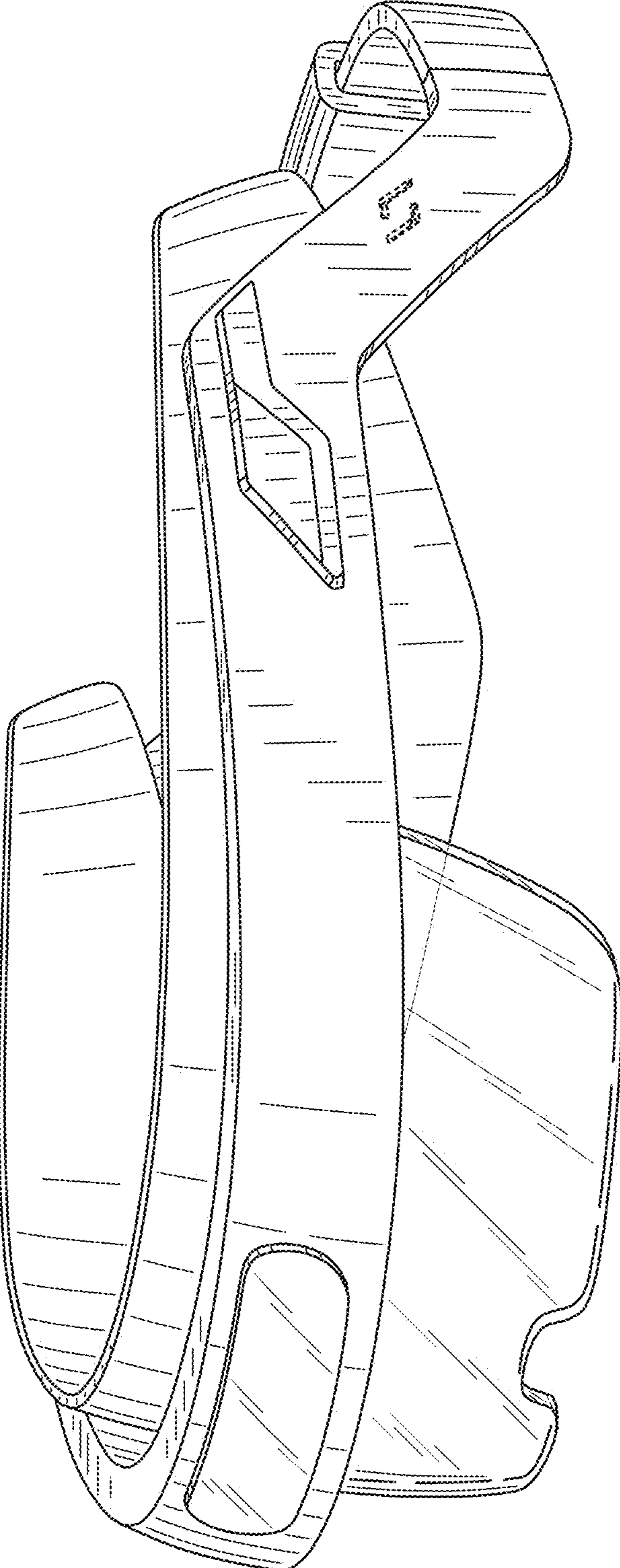

FIG. 2

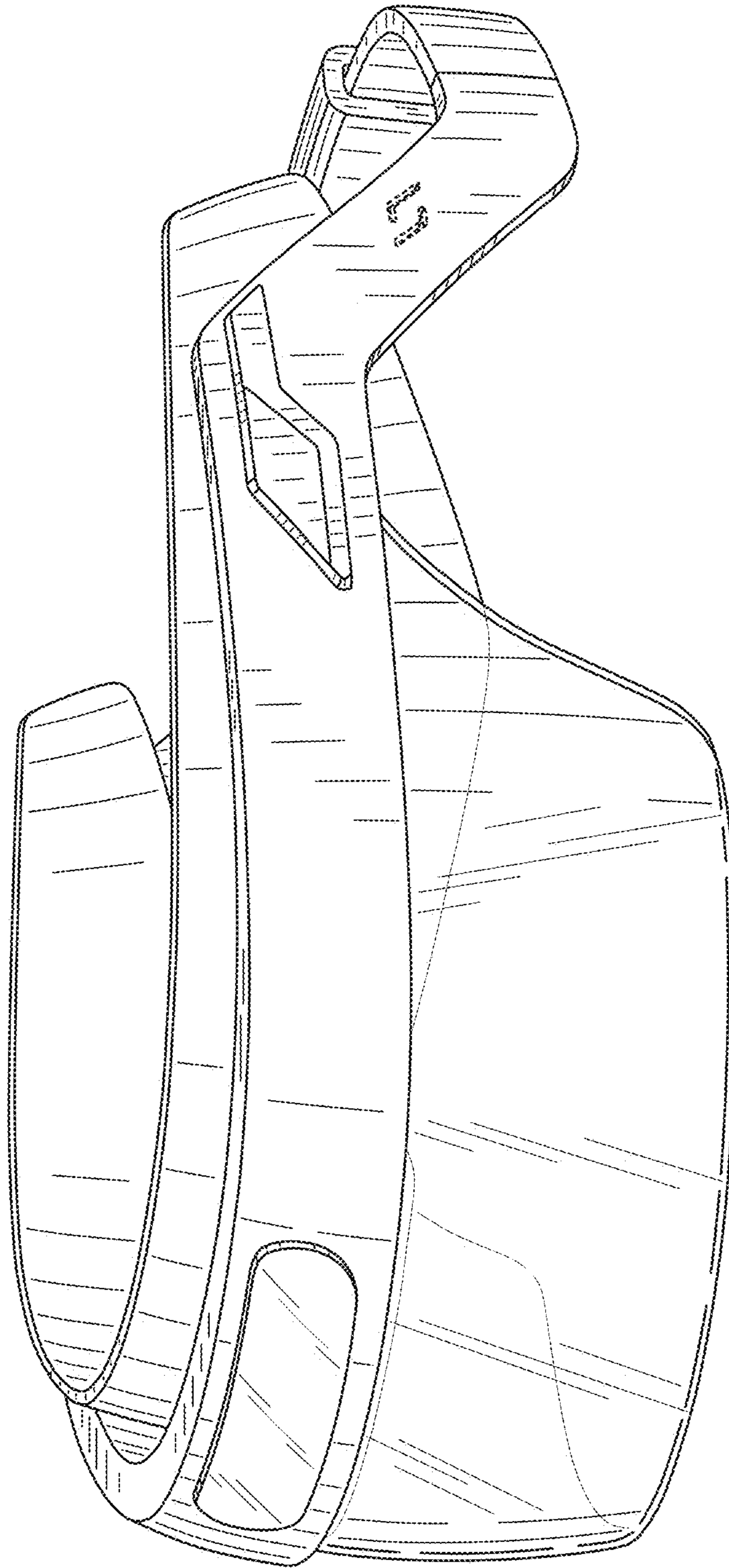

FIG. 3

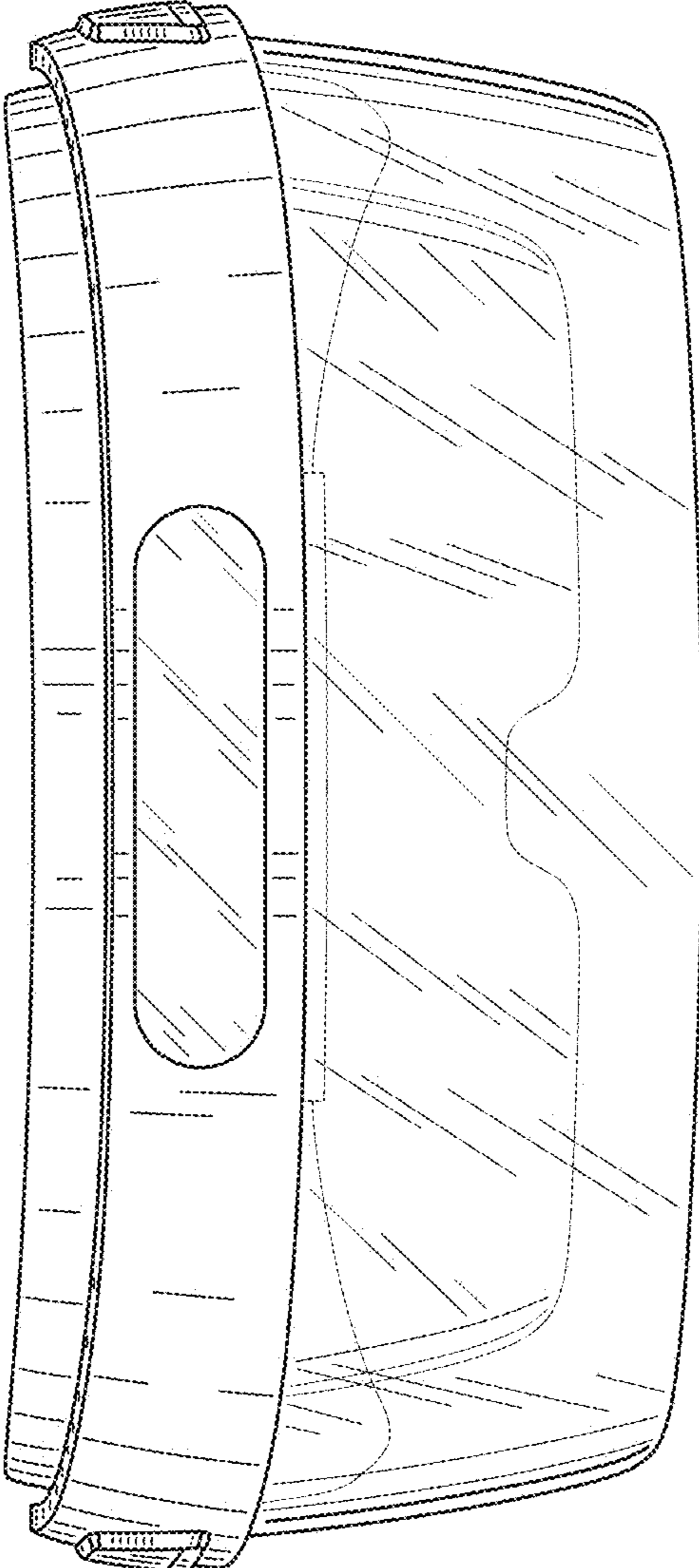

FIG. 4

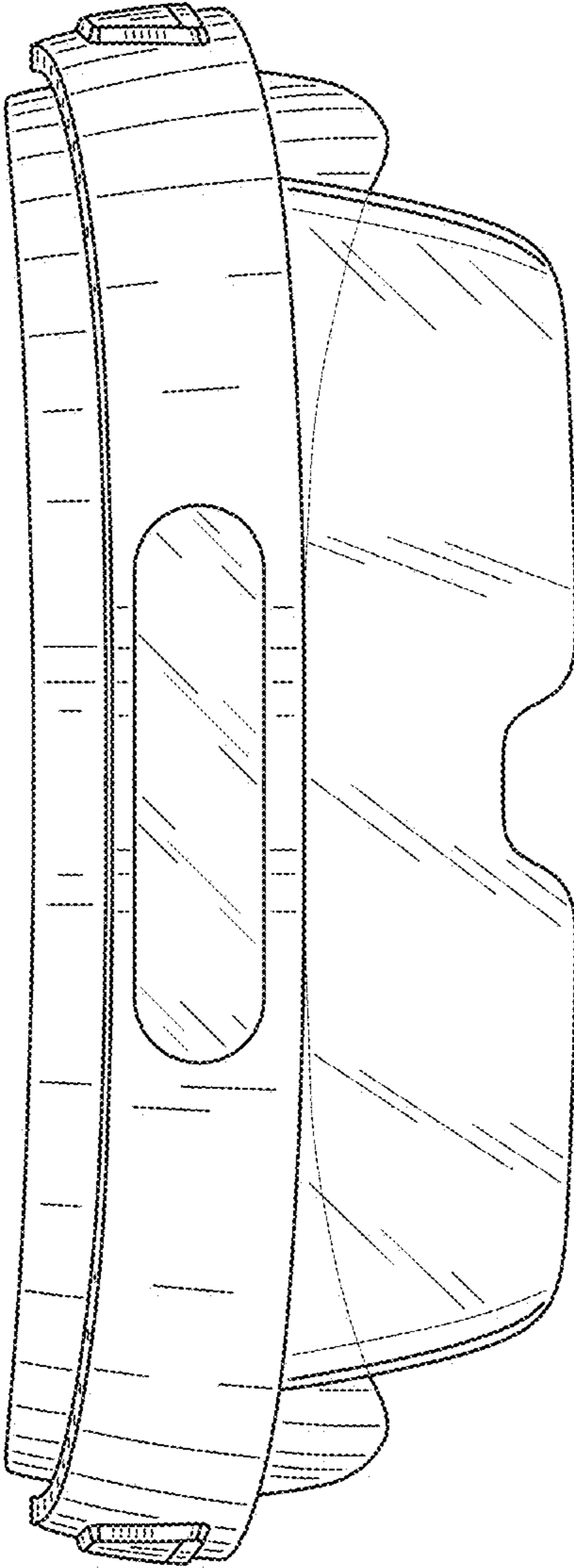

FIG. 5

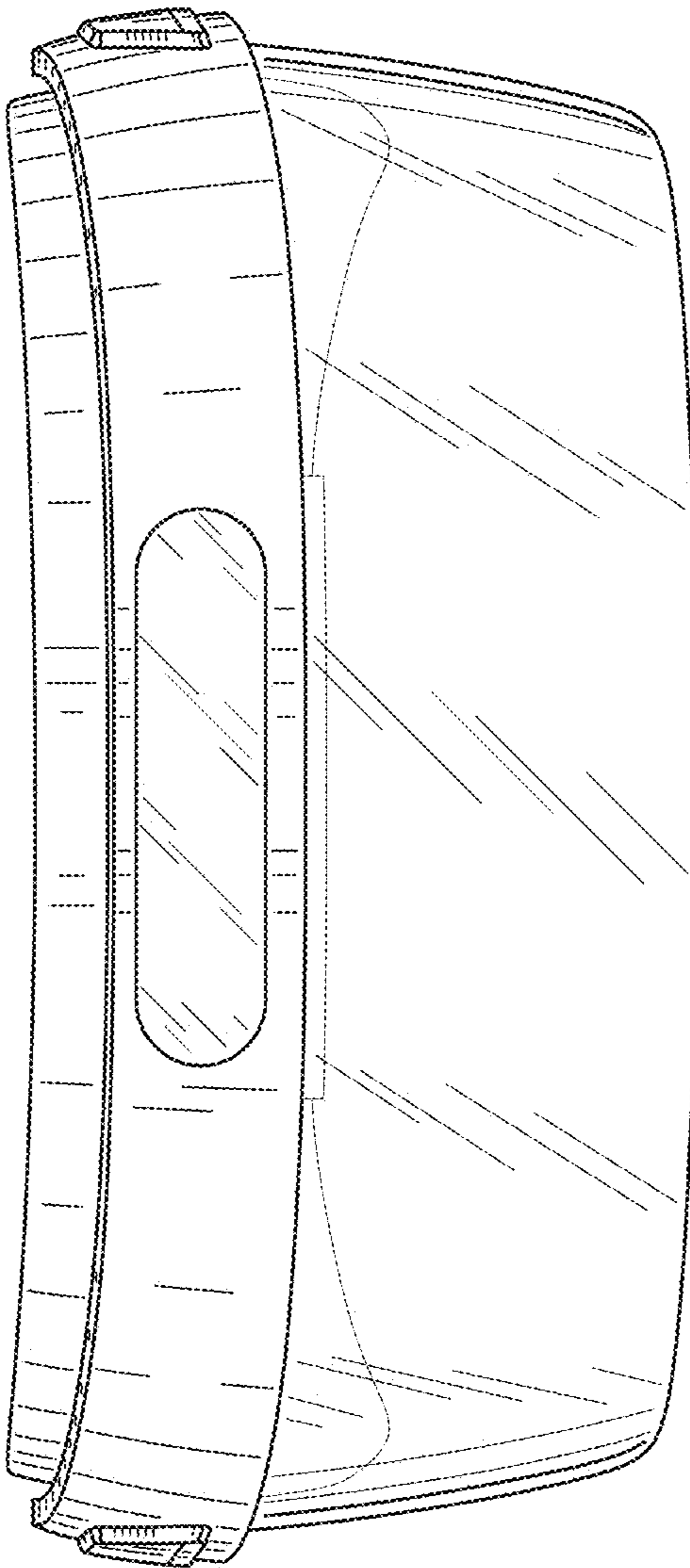

FIG. 6

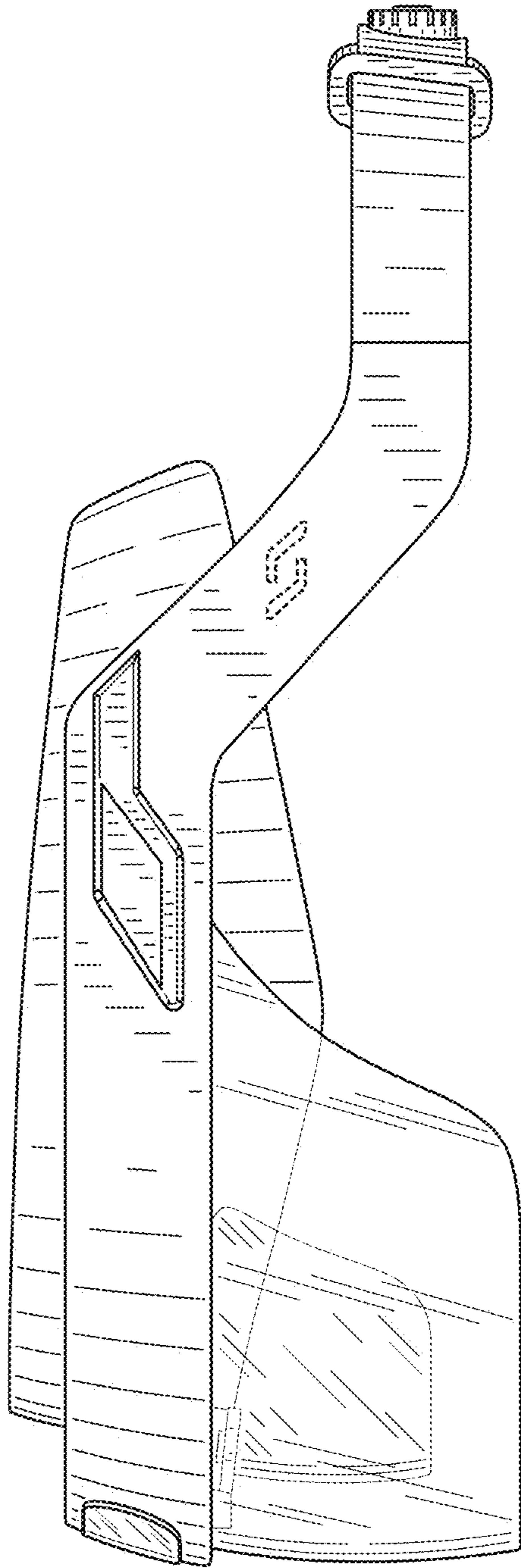

FIG. 7

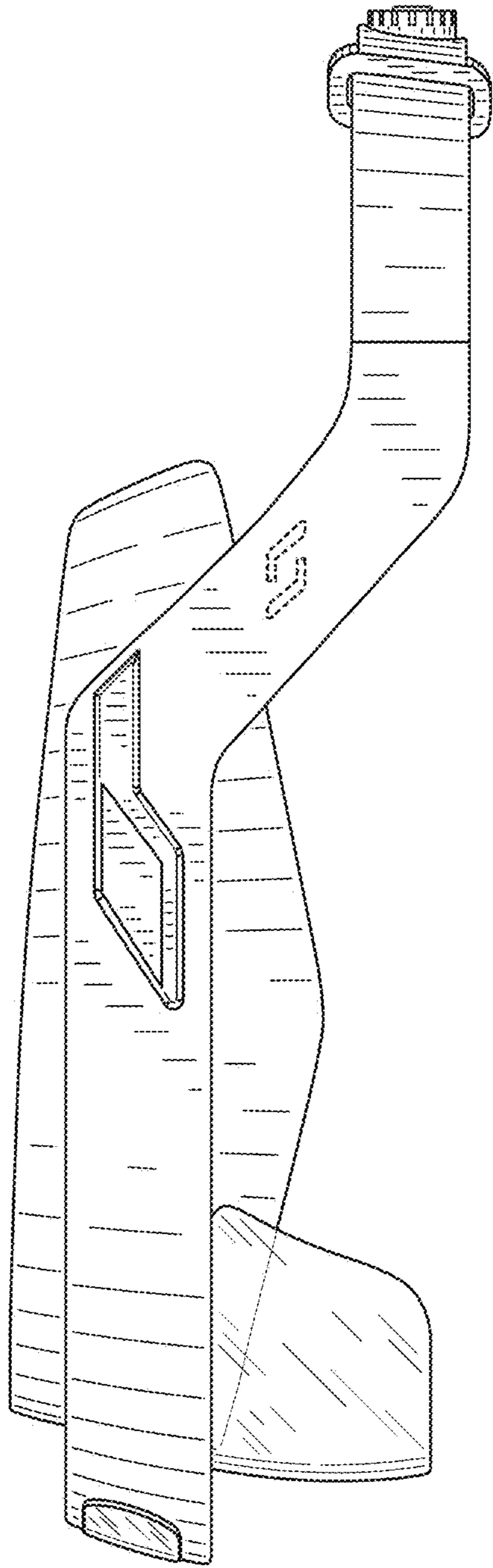

FIG. 8

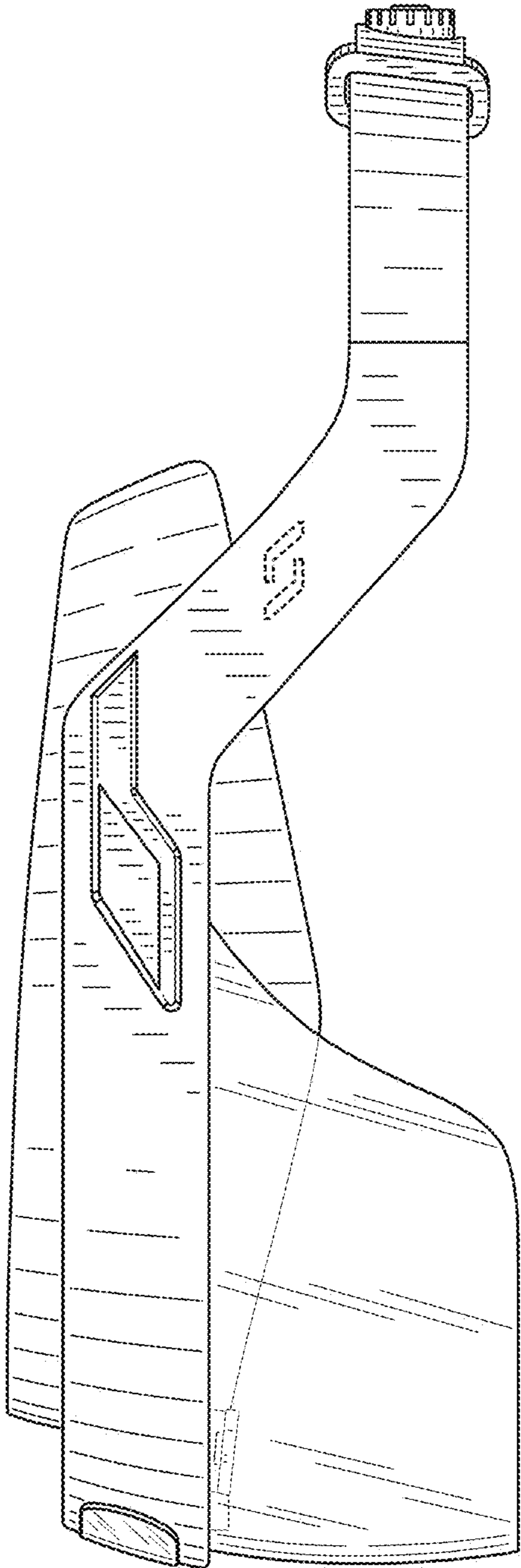

FIG. 9

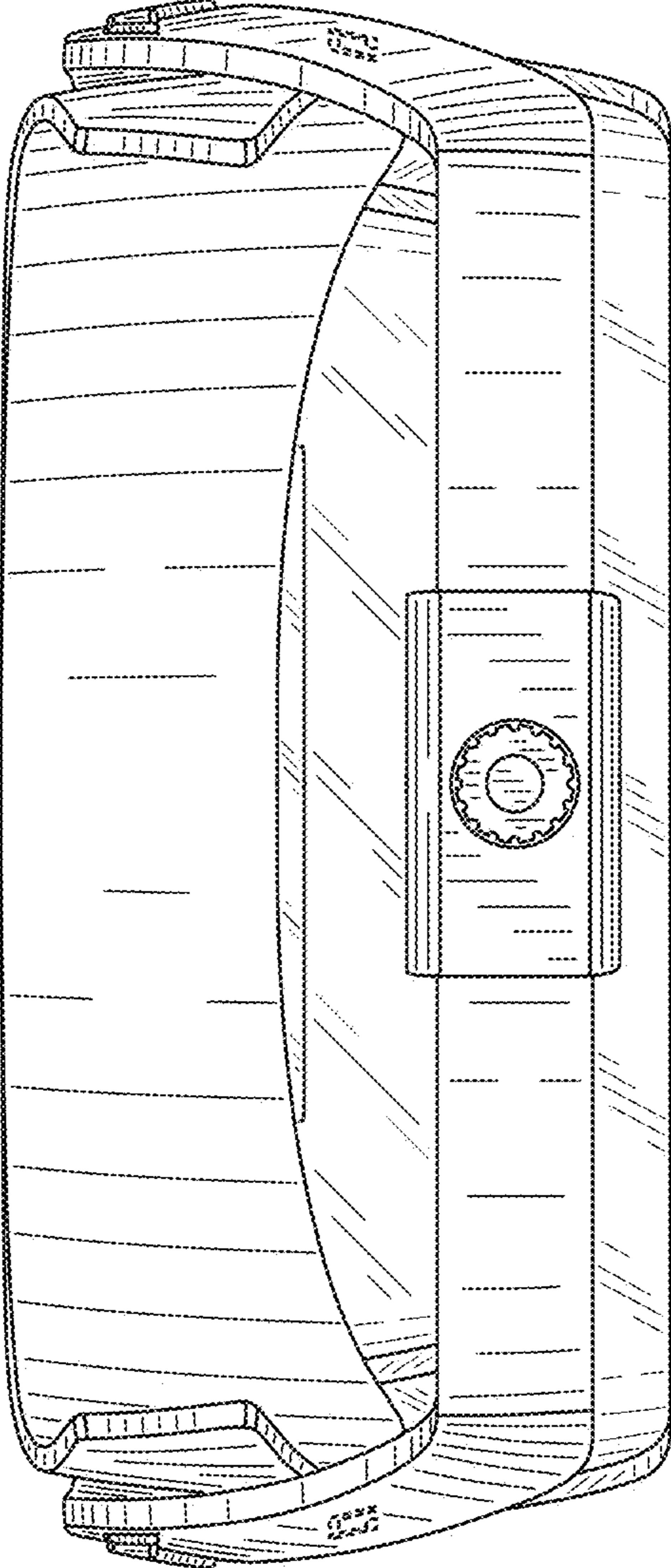

FIG. 10

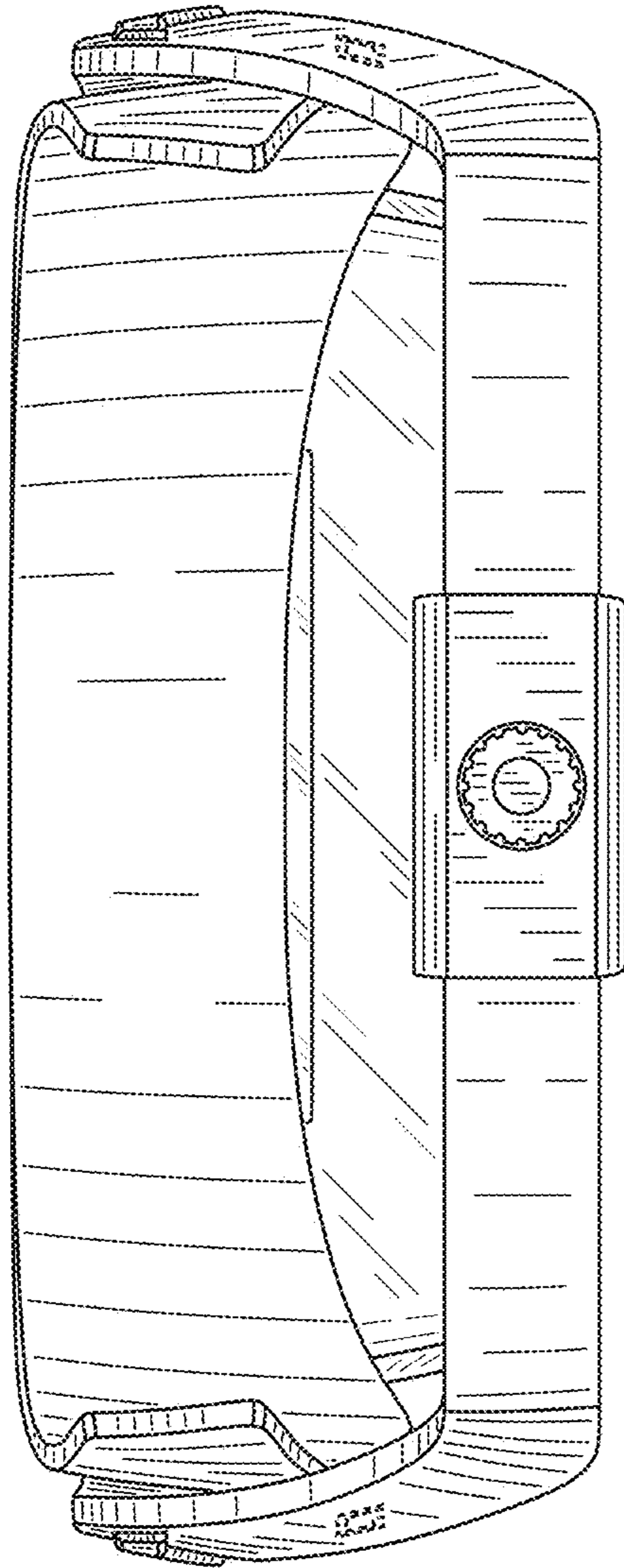

FIG. 11

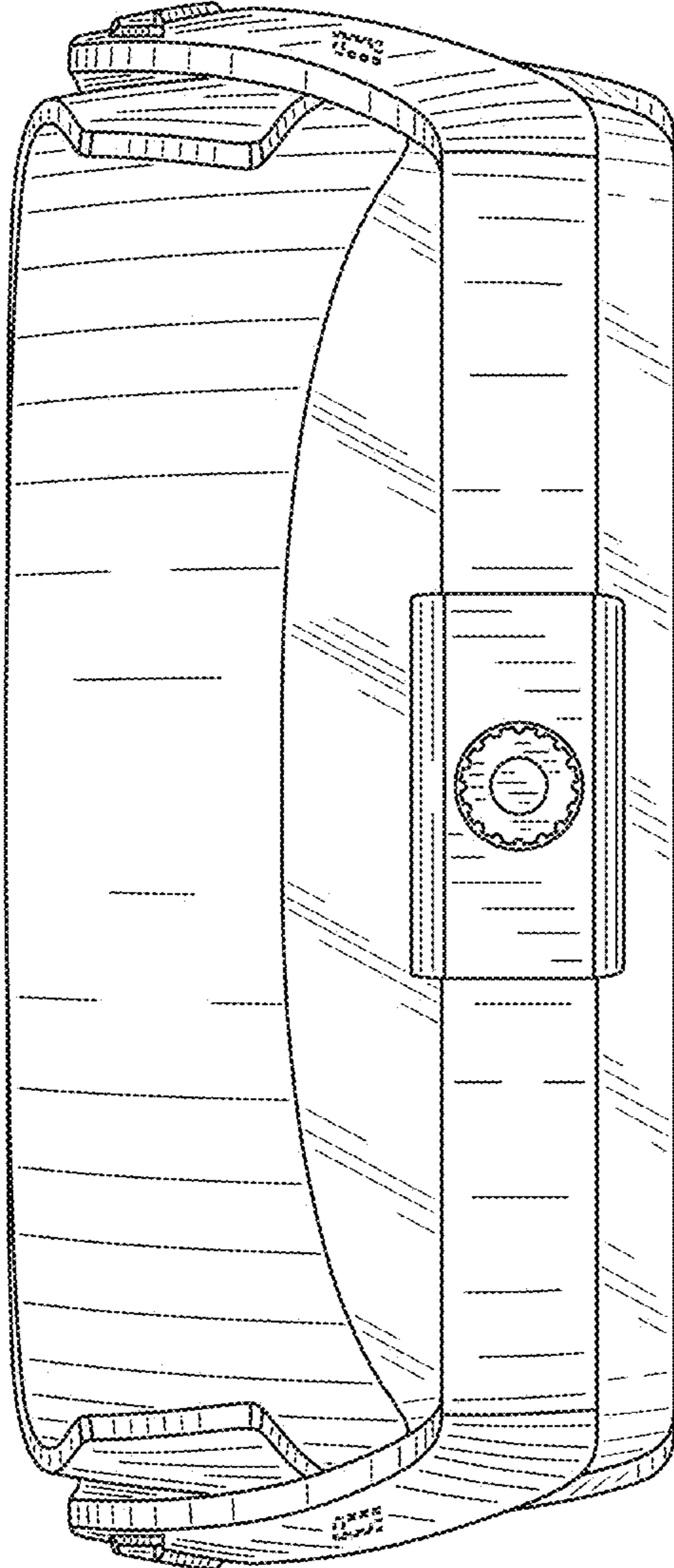

FIG. 12

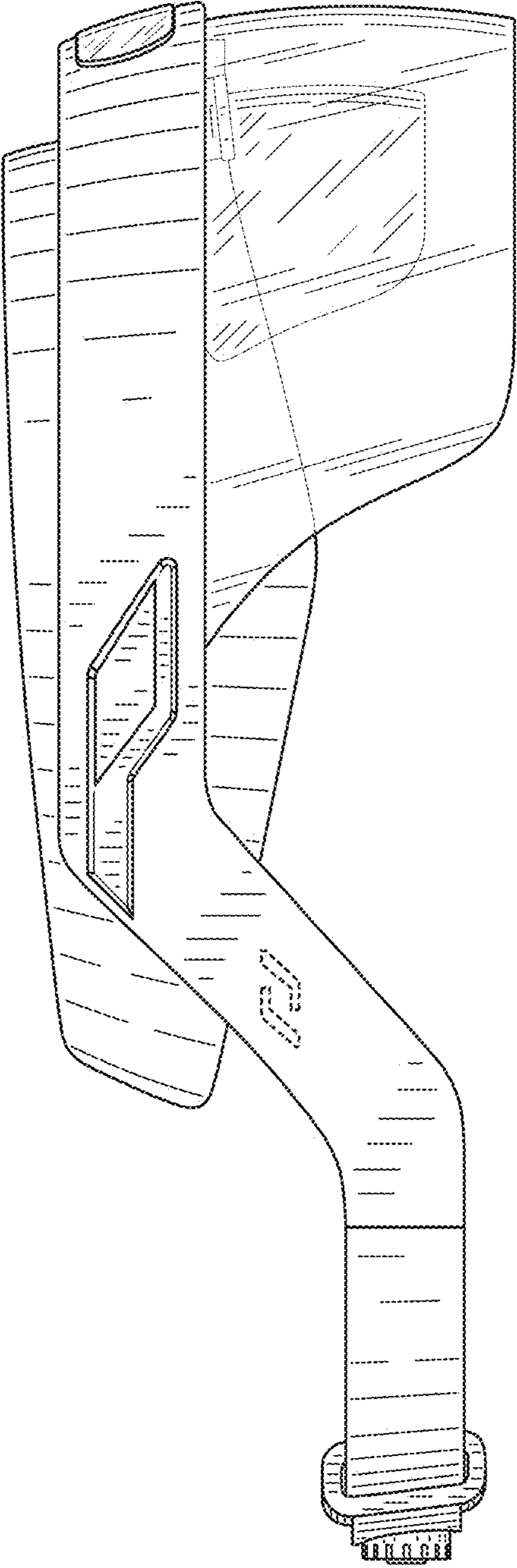

FIG. 13

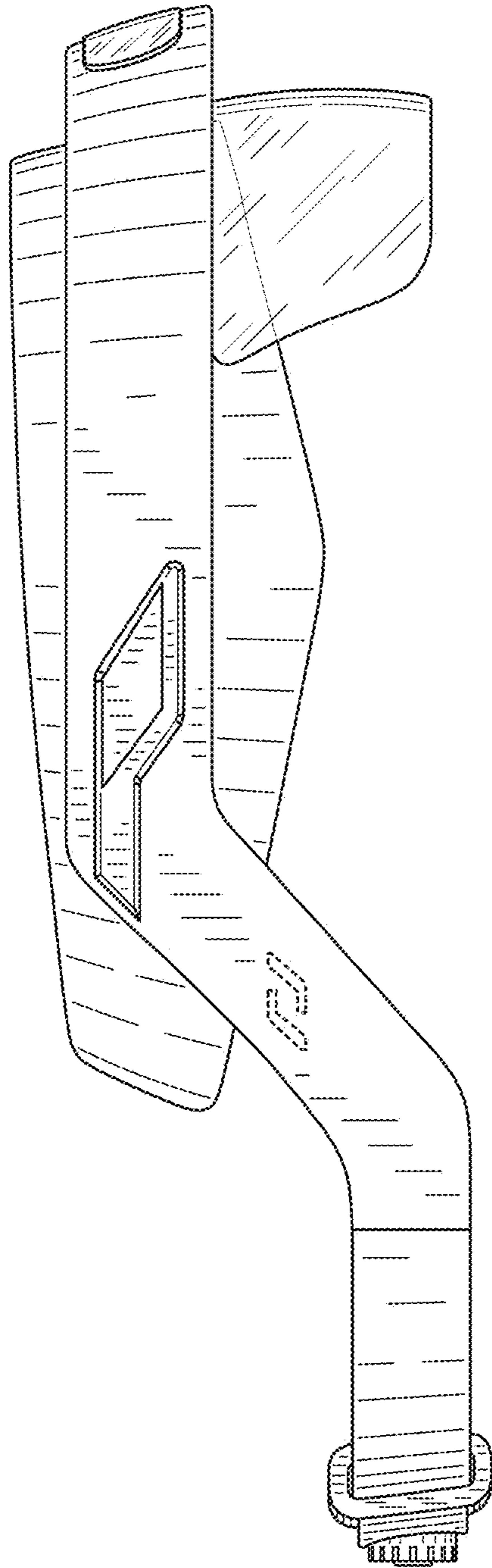

FIG. 14

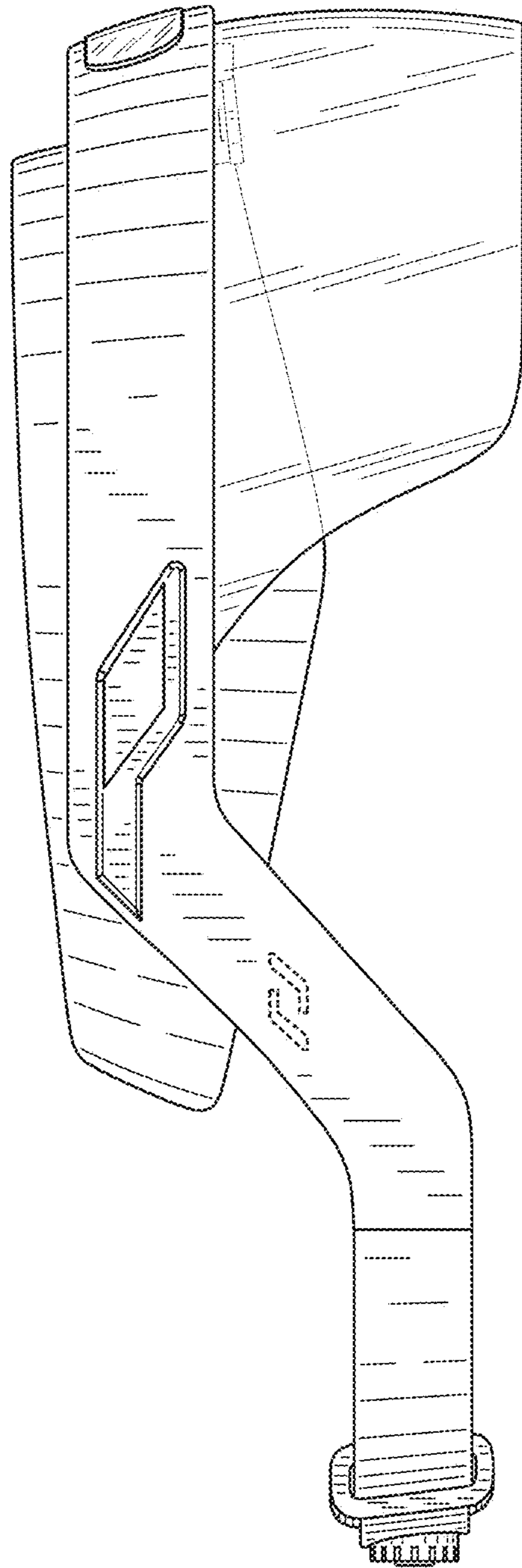

FIG. 15

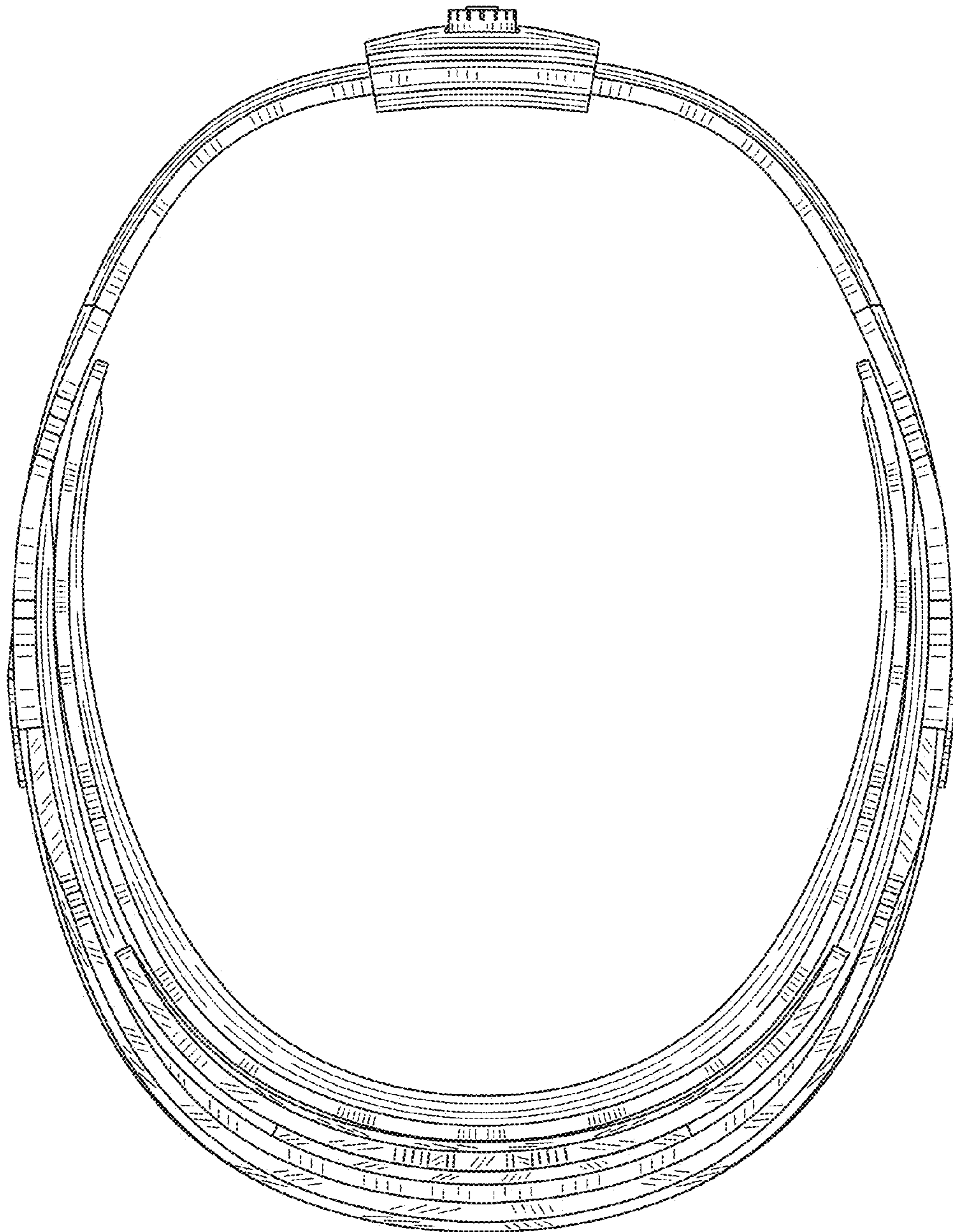

FIG. 16

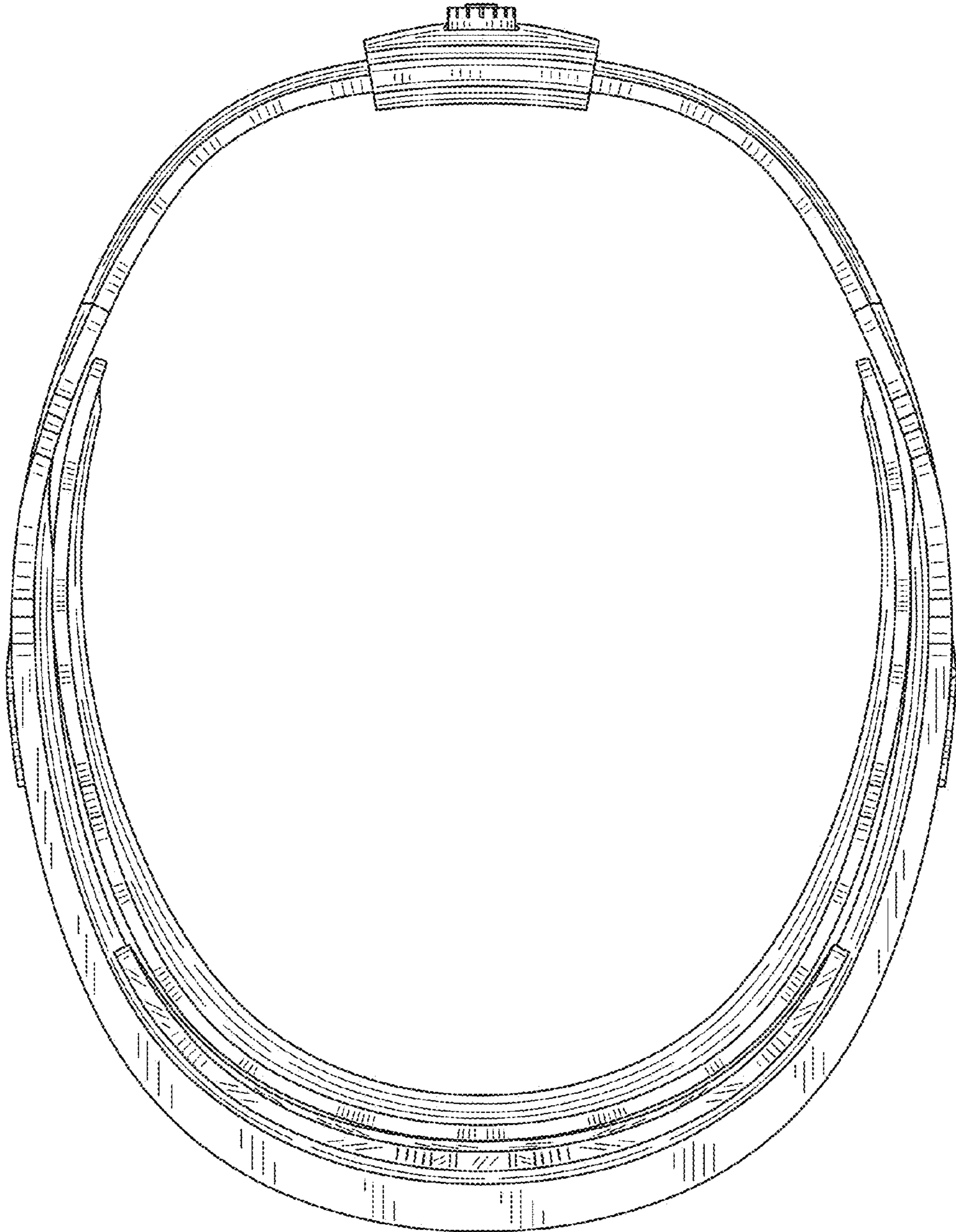

FIG. 17

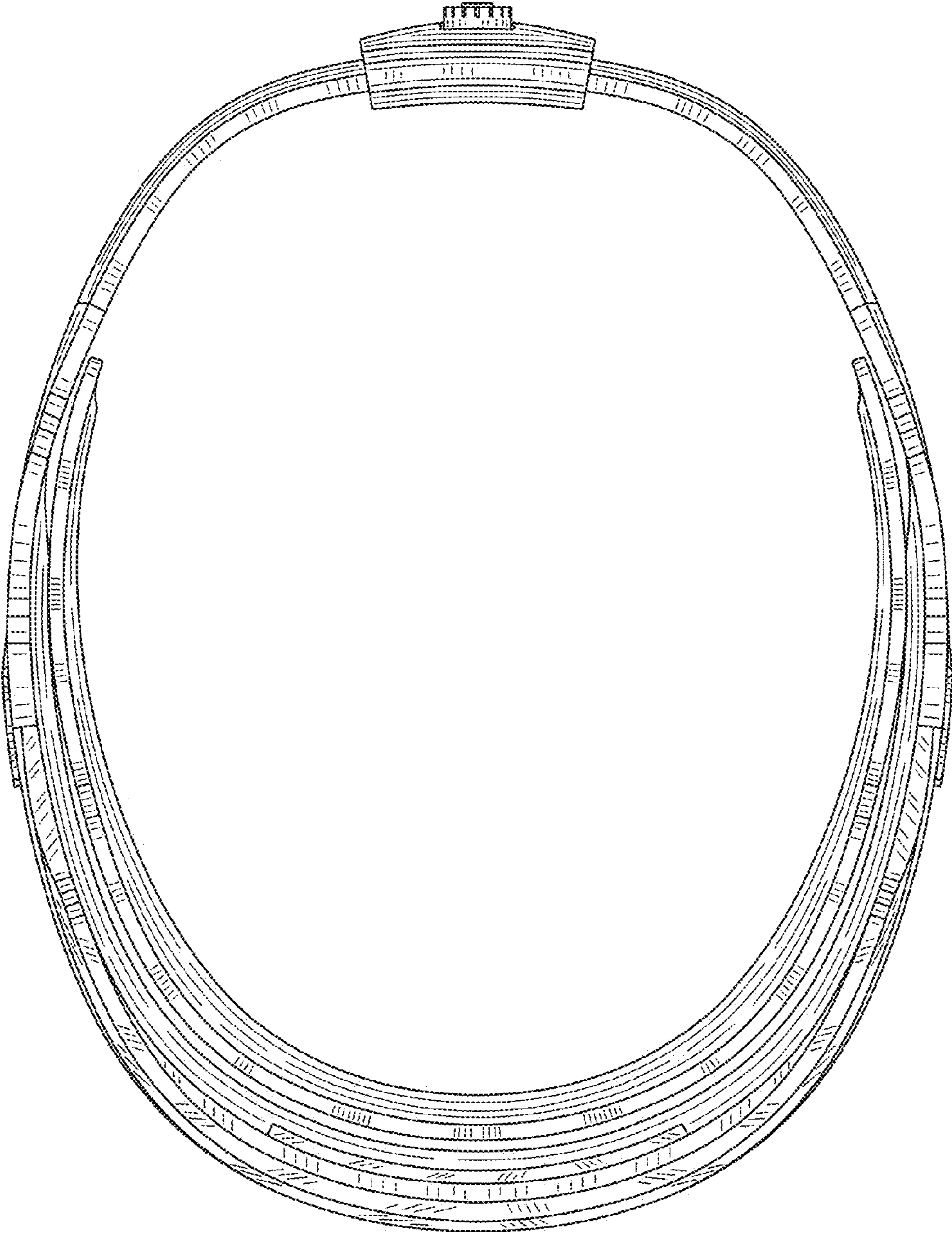

FIG. 18

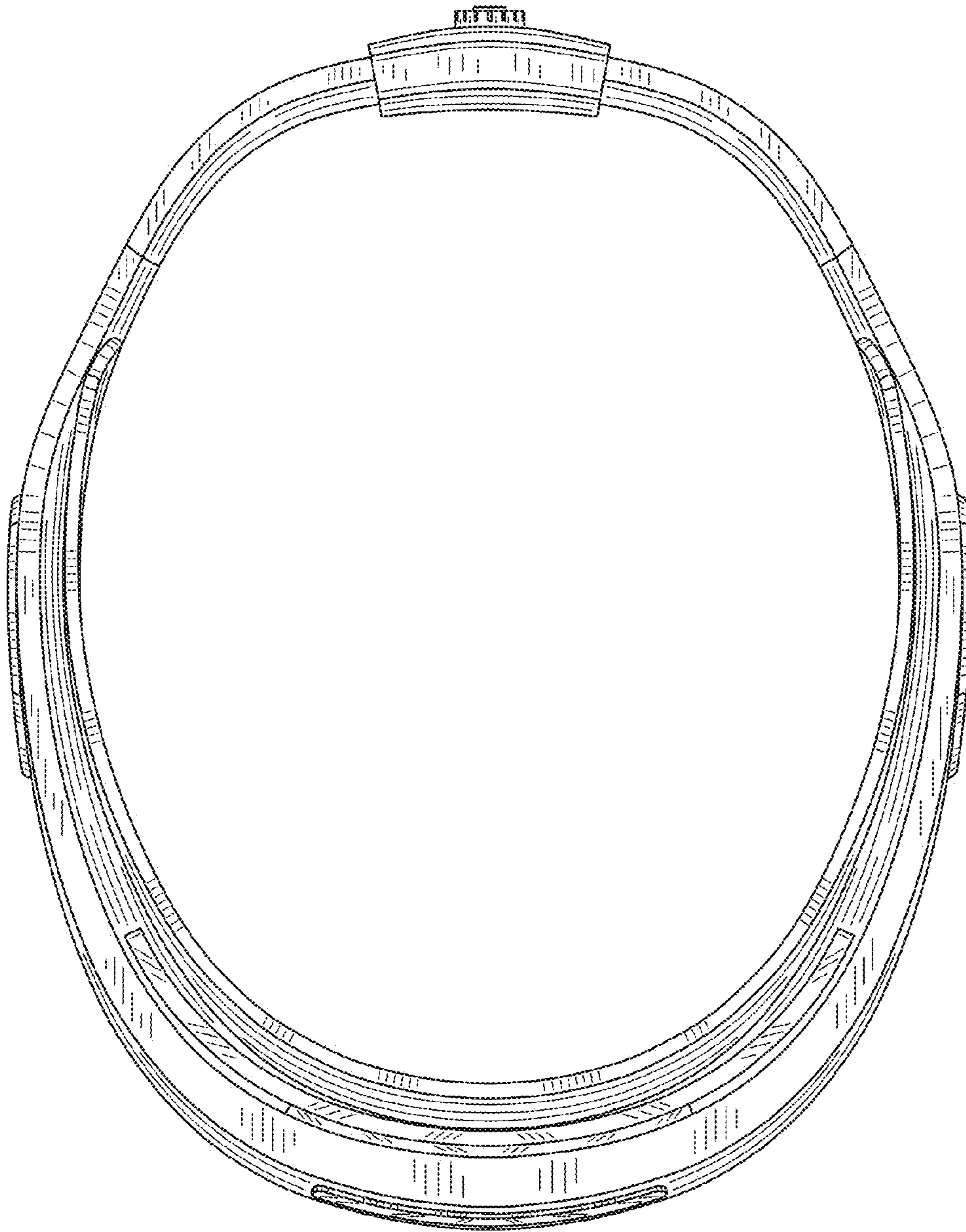

FIG. 19