



US00D750327S

(12) **United States Design Patent**  
**Patchen**

(10) **Patent No.:** **US D750,327 S**

(45) **Date of Patent:** **\*\* Feb. 23, 2016**

(54) **BACK SCRATCHER**

(71) Applicant: **Garth Patchen**, Moore, SC (US)

(72) Inventor: **Garth Patchen**, Moore, SC (US)

(\*\*) Term: **15 Years**

(21) Appl. No.: **29/540,045**

(22) Filed: **Sep. 21, 2015**

**Related U.S. Application Data**

(63) Continuation-in-part of application No. 29/473,221, filed on Nov. 20, 2013, now Pat. No. Des. 739,608.

(51) **LOC (10) Cl.** ..... **28-99**

(52) **U.S. Cl.**  
USPC ..... **D28/91.2**

(58) **Field of Classification Search**  
USPC ..... D28/91.2; D24/211-215; 601/135, 137;  
132/150; D7/693-696  
CPC . A61H 7/003; A61H 2205/081; A45D 24/02;  
A45D 24/12; A45D 24/14  
See application file for complete search history.

(56) **References Cited**

**U.S. PATENT DOCUMENTS**

D266,280	S	*	9/1982	Toyama	.....	D28/99
D563,601	S	*	3/2008	Gabriz	.....	D28/91.2
D688,009	S	*	8/2013	Mahoney, Jr.	.....	D28/91.2
2007/0066919	A1	*	3/2007	Gueret	.....	A61H 7/003 601/138

**OTHER PUBLICATIONS**

Google image search for “bottle cap scaler” date restricted to before Sep. 21, 2014.\*

Google image search for “bottle cap back scratcher” date restricted to before Sep. 21, 2014.\*

\* cited by examiner

*Primary Examiner* — Jennifer Rivard

(74) *Attorney, Agent, or Firm* — J. Bennett Mullinax, LLC

(57) **CLAIM**

The ornamental design for a back scratcher, as shown and described.

**DESCRIPTION**

FIG. 1 is a top perspective view of the back scratcher of the present design;

FIG. 2 is a top plan view of the back scratcher as shown in FIG. 1;

FIG. 3 is a bottom plan view of the back scratcher as shown in FIG. 1;

FIG. 4 is a right side view of the back scratcher as shown in FIG. 1;

FIG. 5 is a left side view of the back scratcher as shown in FIG. 1;

FIG. 6 is a front view of the back scratcher as shown in FIG. 1; and,

FIG. 7 is a rear view of the back scratcher as shown in FIG. 1.

The dash-dot-dash broken line illustrates the bounds of the claim. The remaining broken lines illustrate portions of the article. None of the broken lines forms part of the claimed design.

**1 Claim, 7 Drawing Sheets**

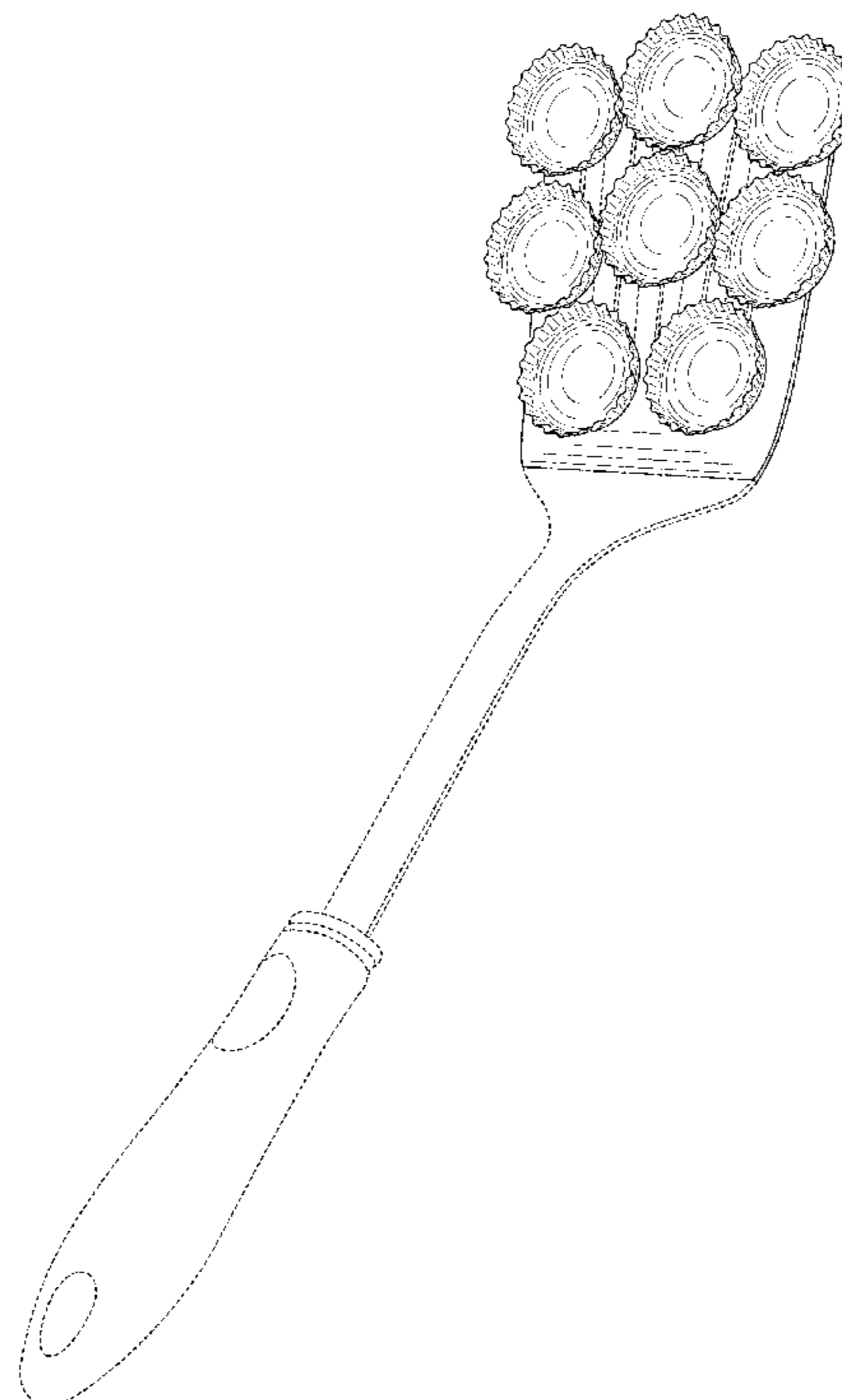

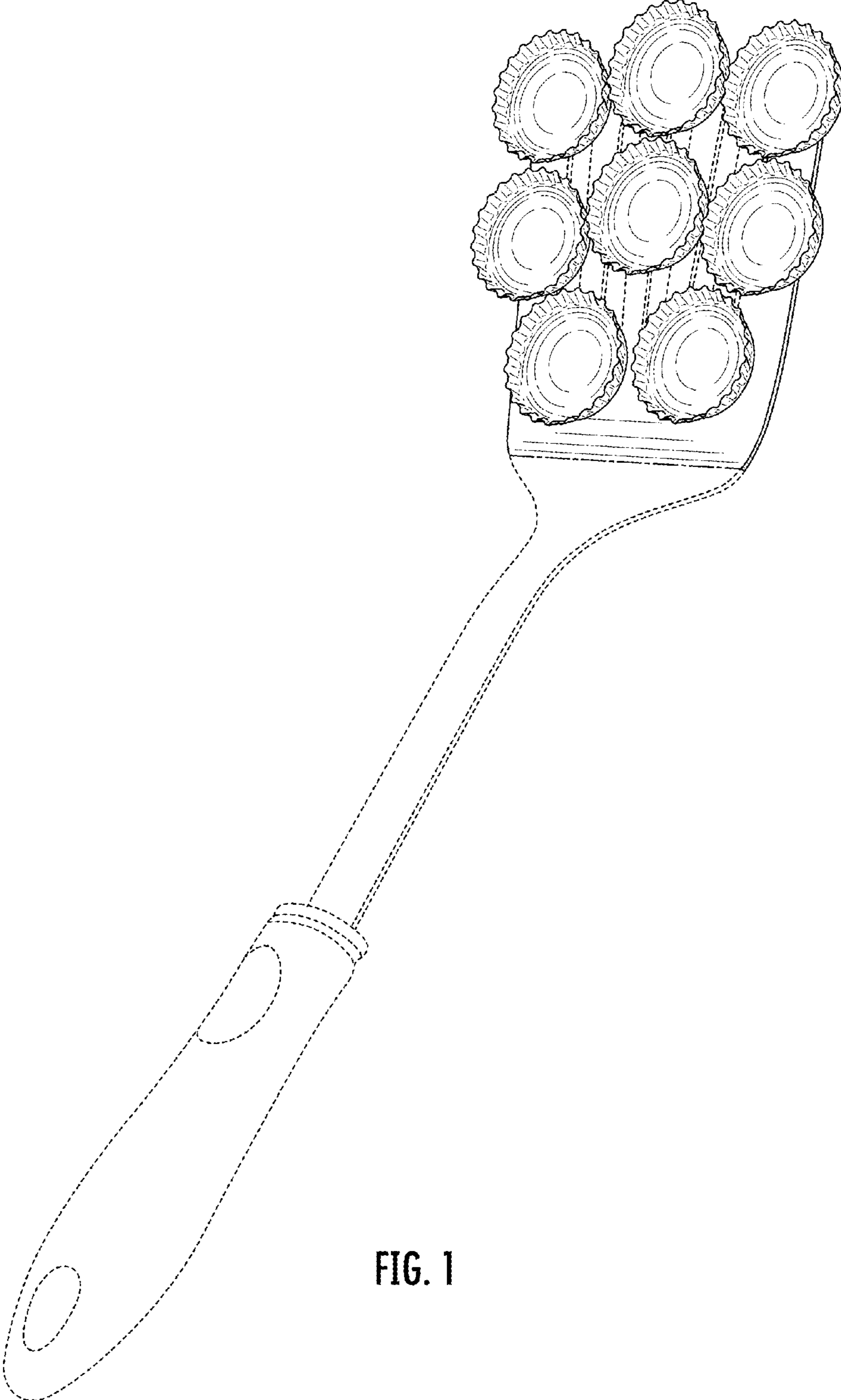

FIG. 1

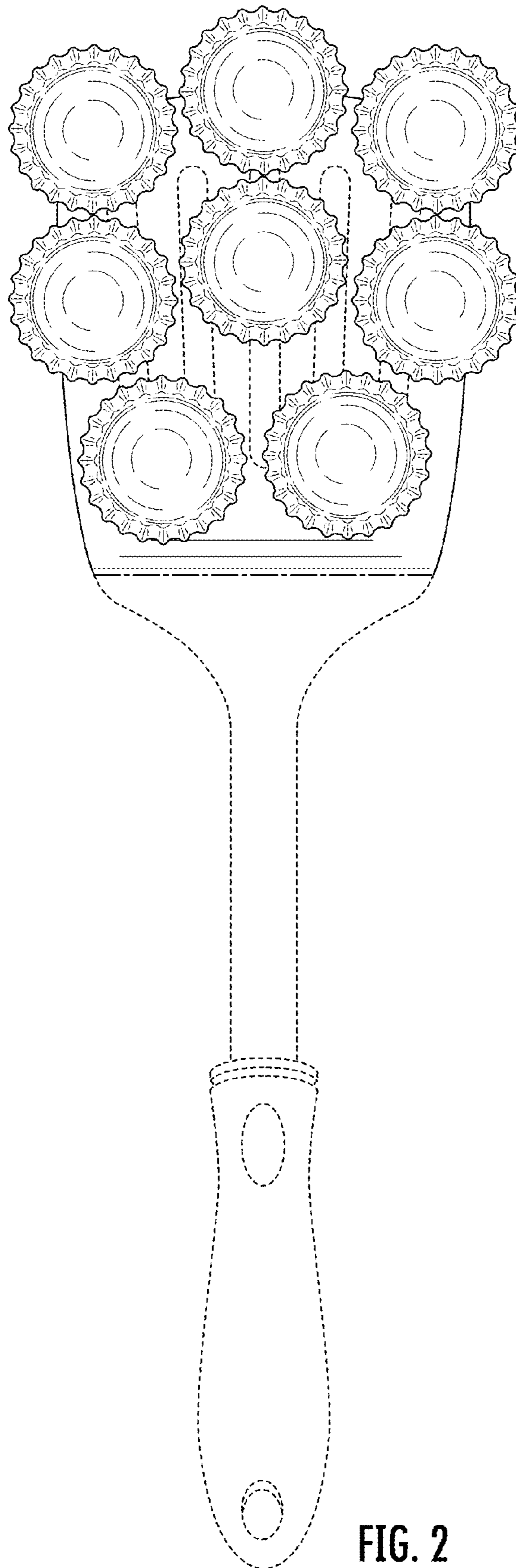

FIG. 2

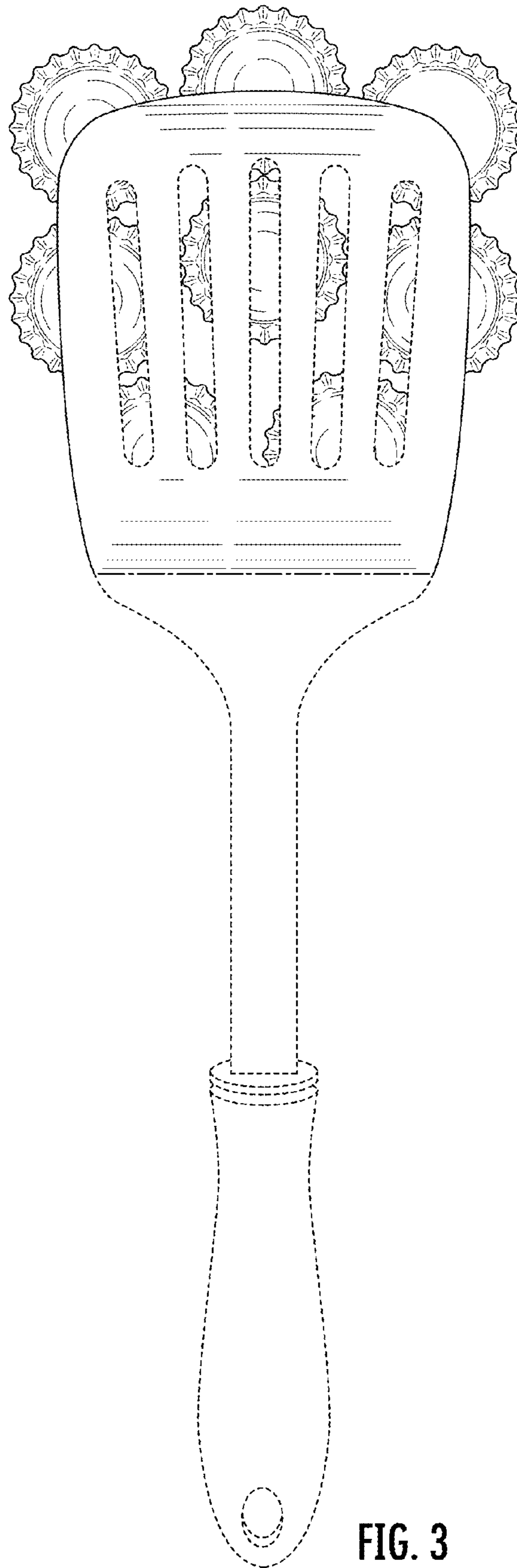

FIG. 3

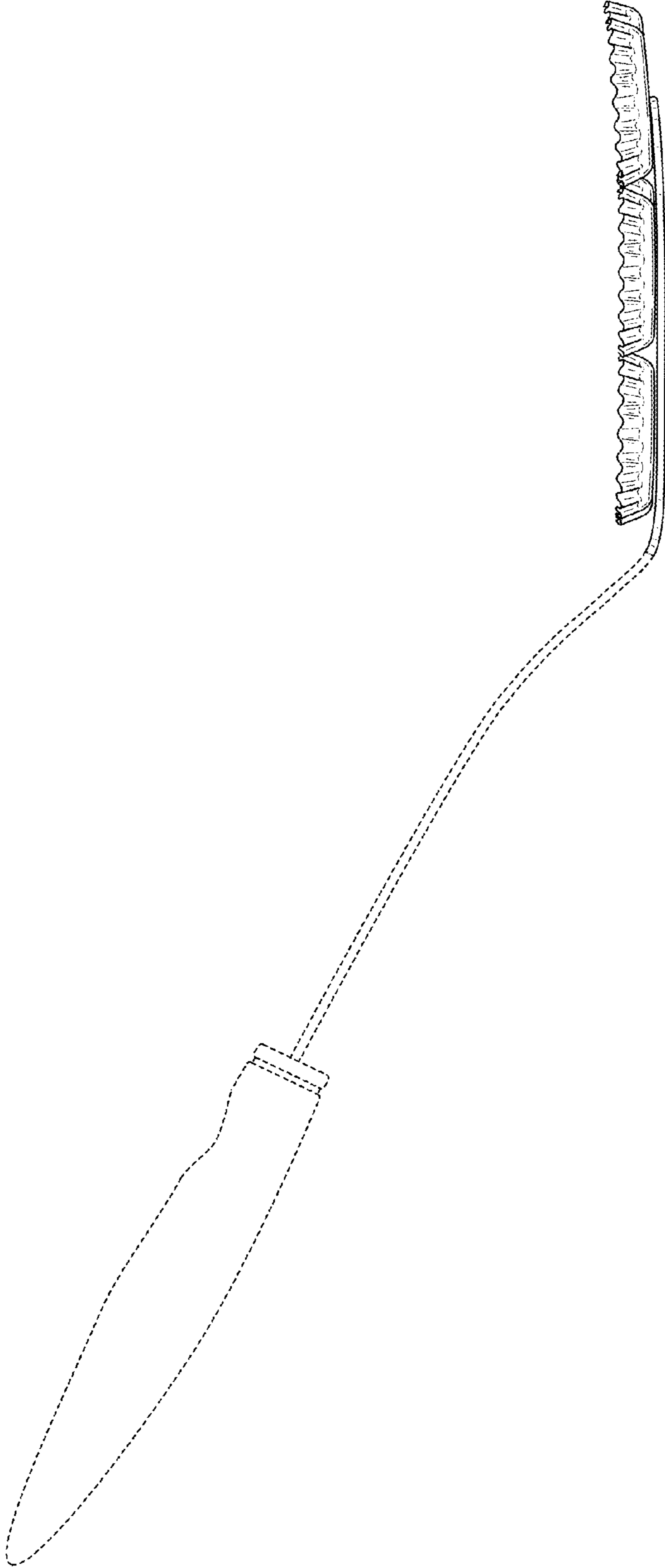

FIG. 4

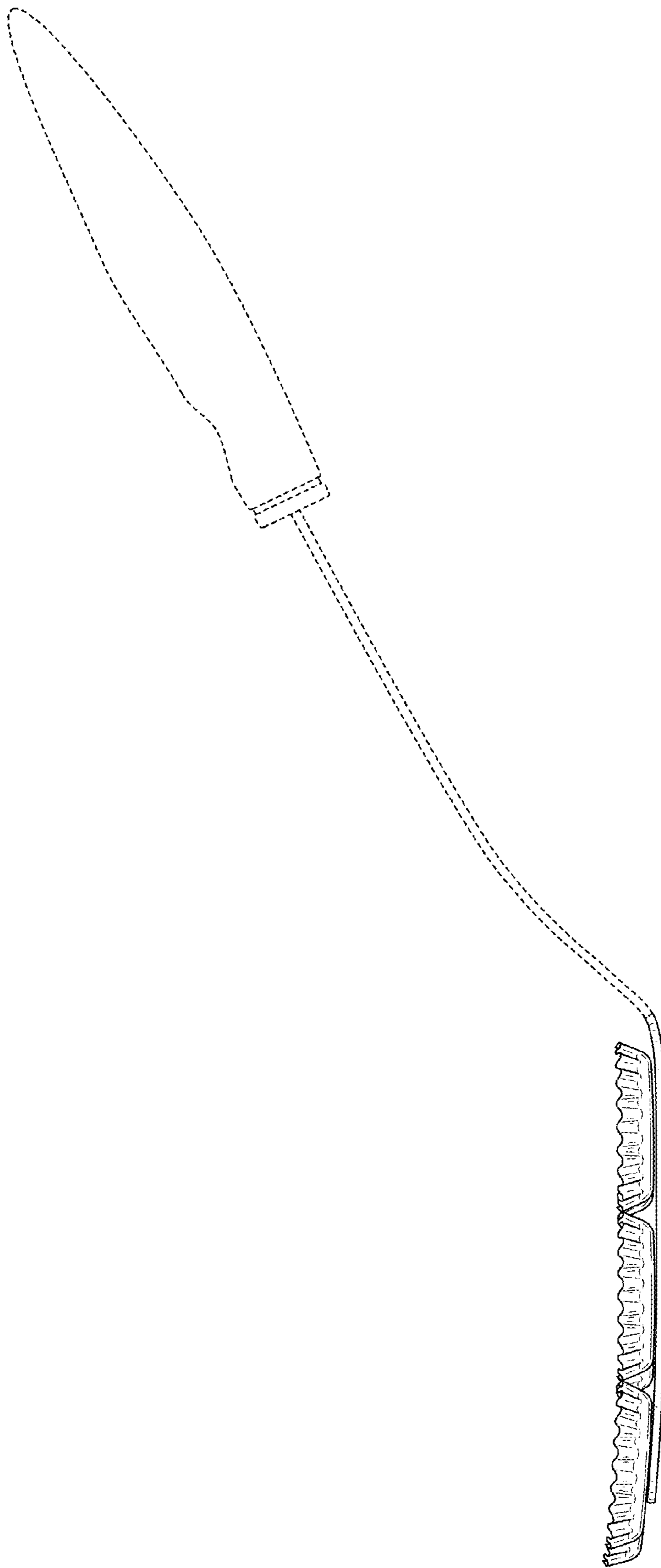

FIG. 5

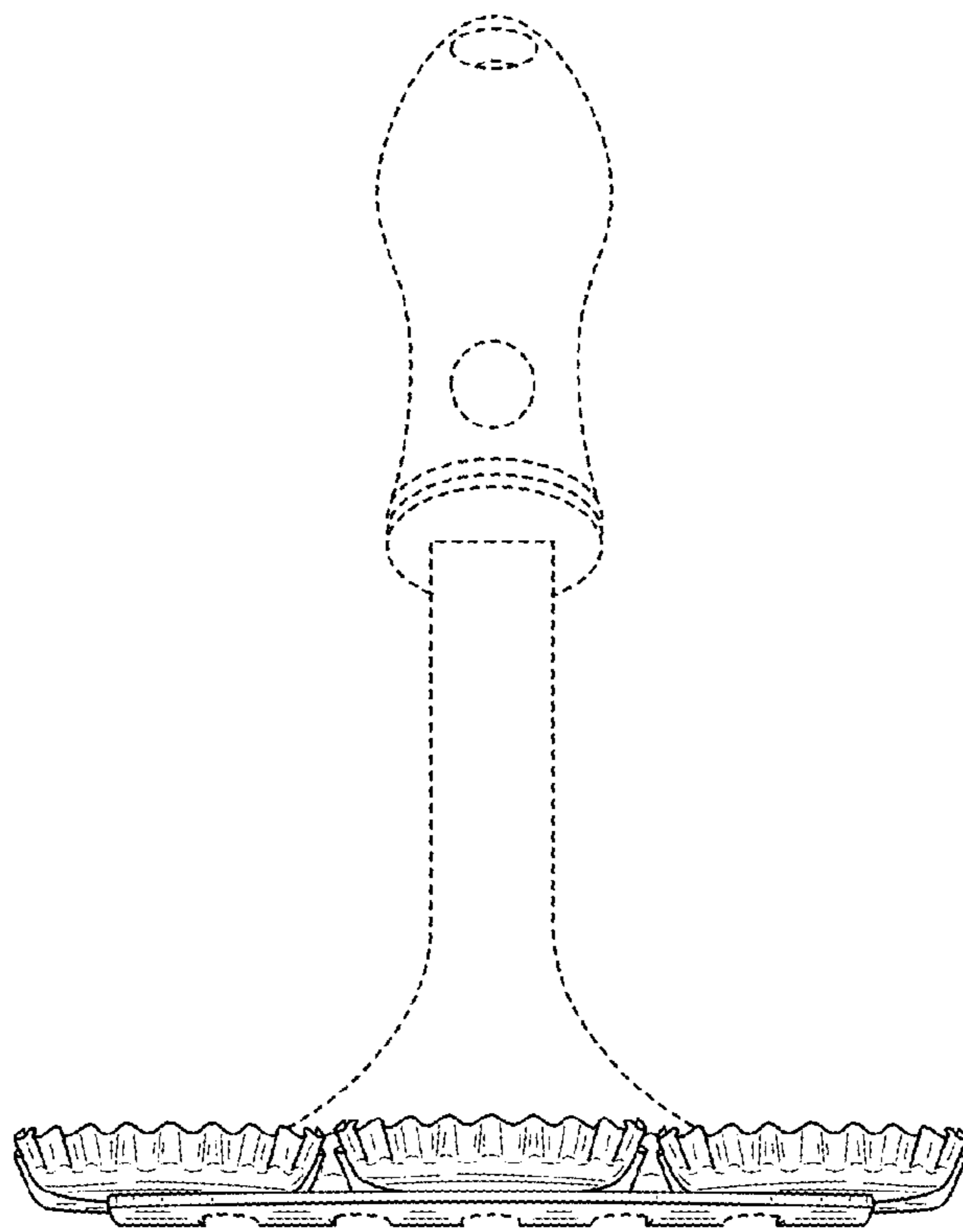

FIG. 6

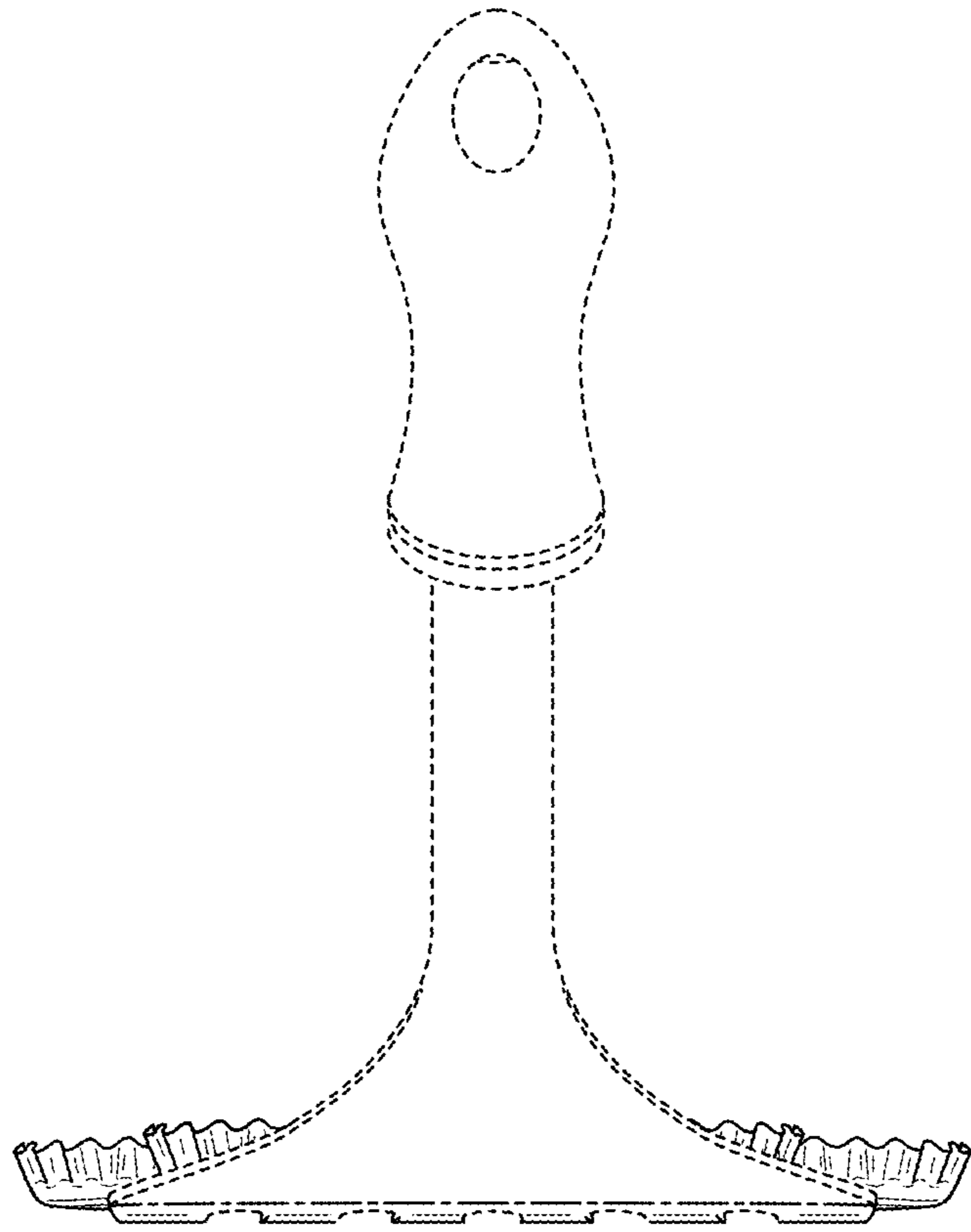

FIG. 7