

US00D750295S

(12) **United States Design Patent**
Gotschke et al.

(10) **Patent No.:** **US D750,295 S**

(45) **Date of Patent:** **** Feb. 23, 2016**

(54) **VEHICLE TAIL LAMP**

(71) Applicant: **Ford Motor Company**, Dearborn, MI (US)

(72) Inventors: **Wolfgang Gotschke**, Cologne (DE);
Uwe Pulver, Cologne (DE)

(73) Assignee: **Ford Motor Company**, Dearborn, MI (US)

(**) Term: **14 Years**

(21) Appl. No.: **29/482,064**

(22) Filed: **Feb. 13, 2014**

(51) **LOC (10) Cl.** **26-06**

(52) **U.S. Cl.**
USPC **D26/28**

(58) **Field of Classification Search**
USPC D26/28-36; 362/459-476, 485-487,
362/543-549
CPC F21S 4/2281; F21S 4/00; F21S 4/225;
F21S 4/2268; F21S 4/1233; F21S 4/1266;
F21S 4/1388; F21V 21/04
See application file for complete search history.

(56) **References Cited**

U.S. PATENT DOCUMENTS

D156,708 S * 1/1950 Domann et al. D26/28
D423,699 S * 4/2000 Hayashi D26/28
D526,073 S * 8/2006 Hagino D26/28

D614,330 S * 4/2010 Lamm et al. D26/28
D614,331 S * 4/2010 Lamm et al. D26/28
D635,696 S * 4/2011 Jeong et al. D26/28
D650,931 S * 12/2011 Lee et al. D26/28
D672,066 S * 12/2012 Saracoglu D26/28
D683,485 S * 5/2013 Lee et al. D26/28
D695,933 S * 12/2013 Kim et al. D26/28

* cited by examiner

Primary Examiner — Cynthia Ramirez

Assistant Examiner — Llorellys Martinez-Rivera

(74) *Attorney, Agent, or Firm* — LeClairRyan

(57) **CLAIM**

The ornamental design for a vehicle tail lamp, as shown and described.

DESCRIPTION

FIG. 1 is a perspective view of a left vehicle tail lamp showing our new design;
FIG. 2 is another perspective view thereof;
FIG. 3 is a front elevational view thereof;
FIG. 4 is a left side elevational view thereof;
FIG. 5 is a right side elevational view thereof;
FIG. 6 is a top plan view thereof; and,
FIG. 7 is a bottom plan view thereof.

The novel design also includes an embodiment of a right vehicle tail lamp which is mirror symmetrical to the embodiment of FIGS. 1-7 and therefore is not separately illustrated.

1 Claim, 7 Drawing Sheets

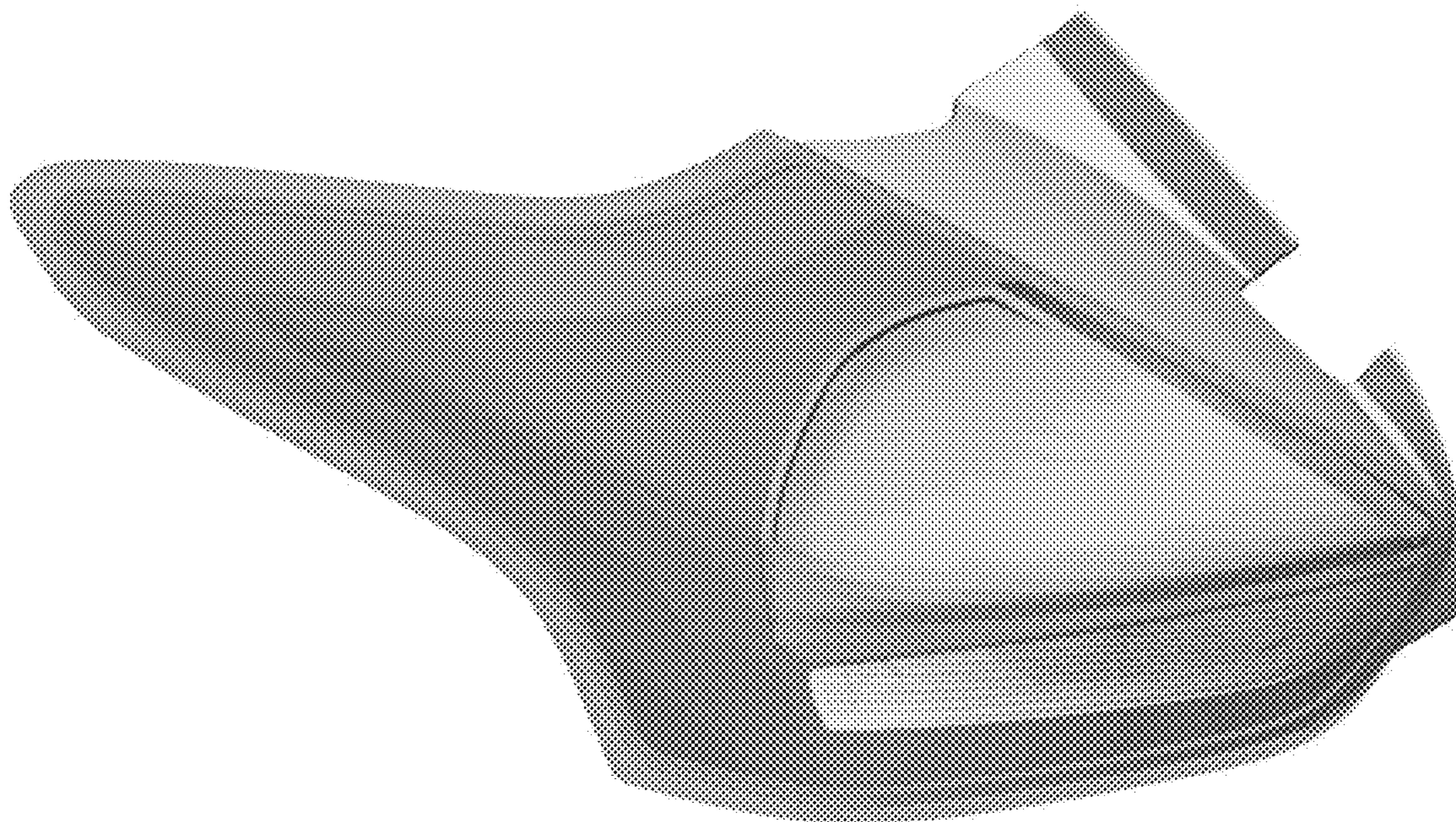

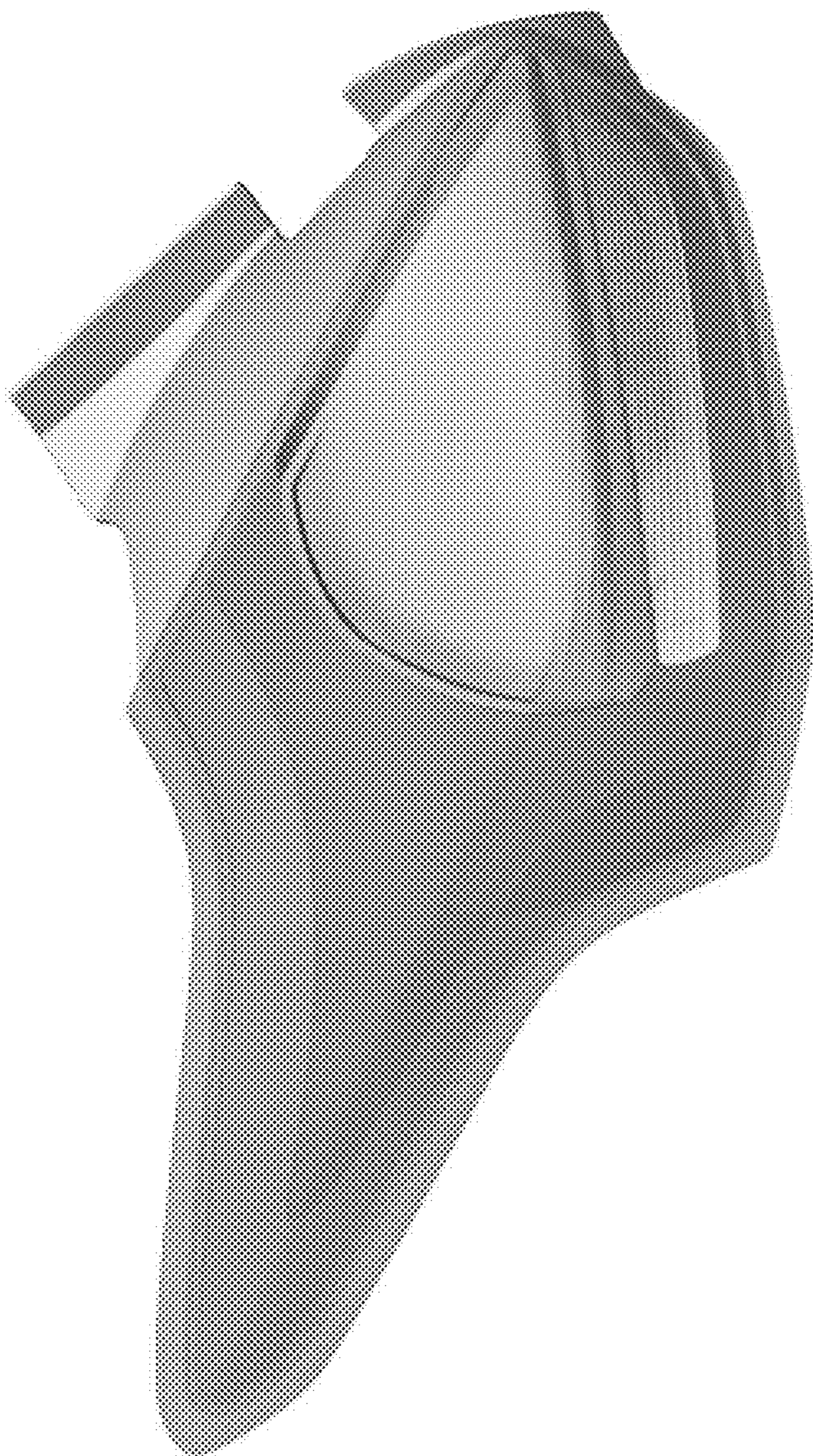

Figure 1

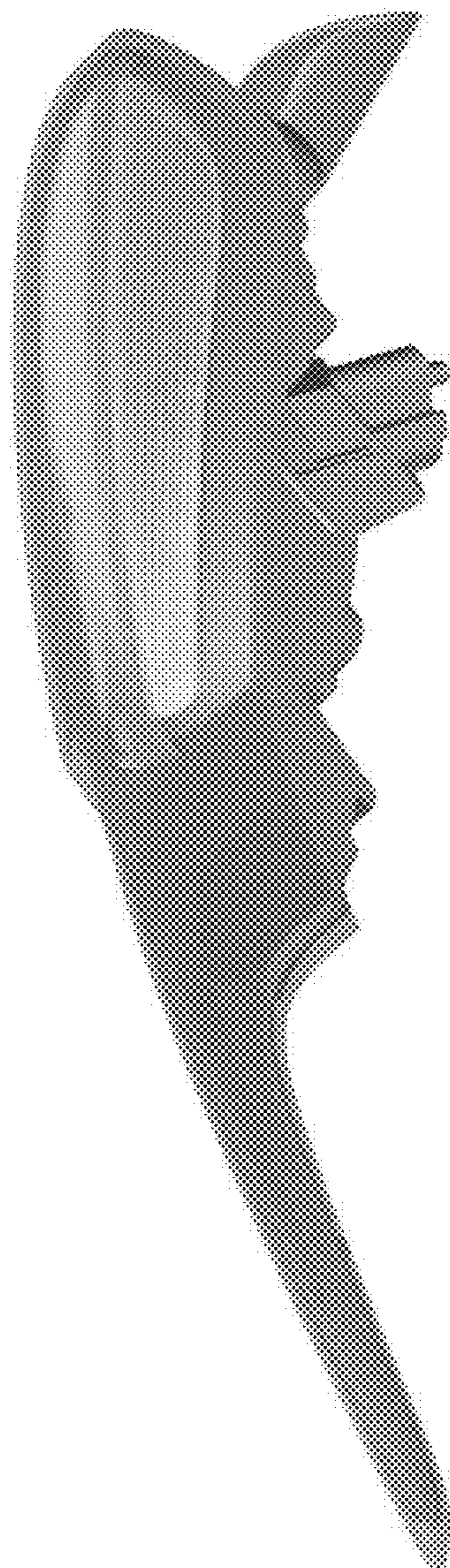

Figure 2

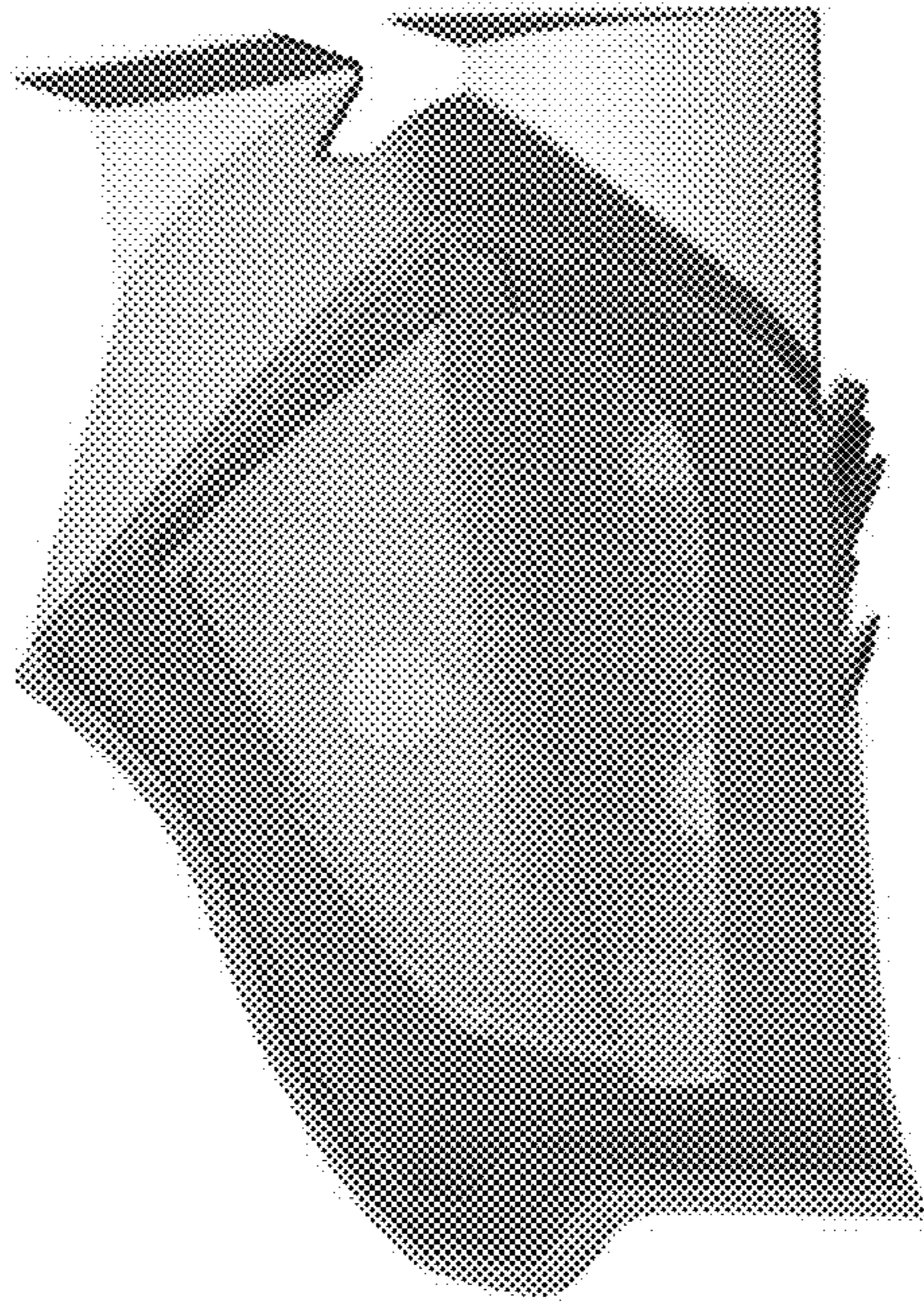

Figure 3



Figure 4

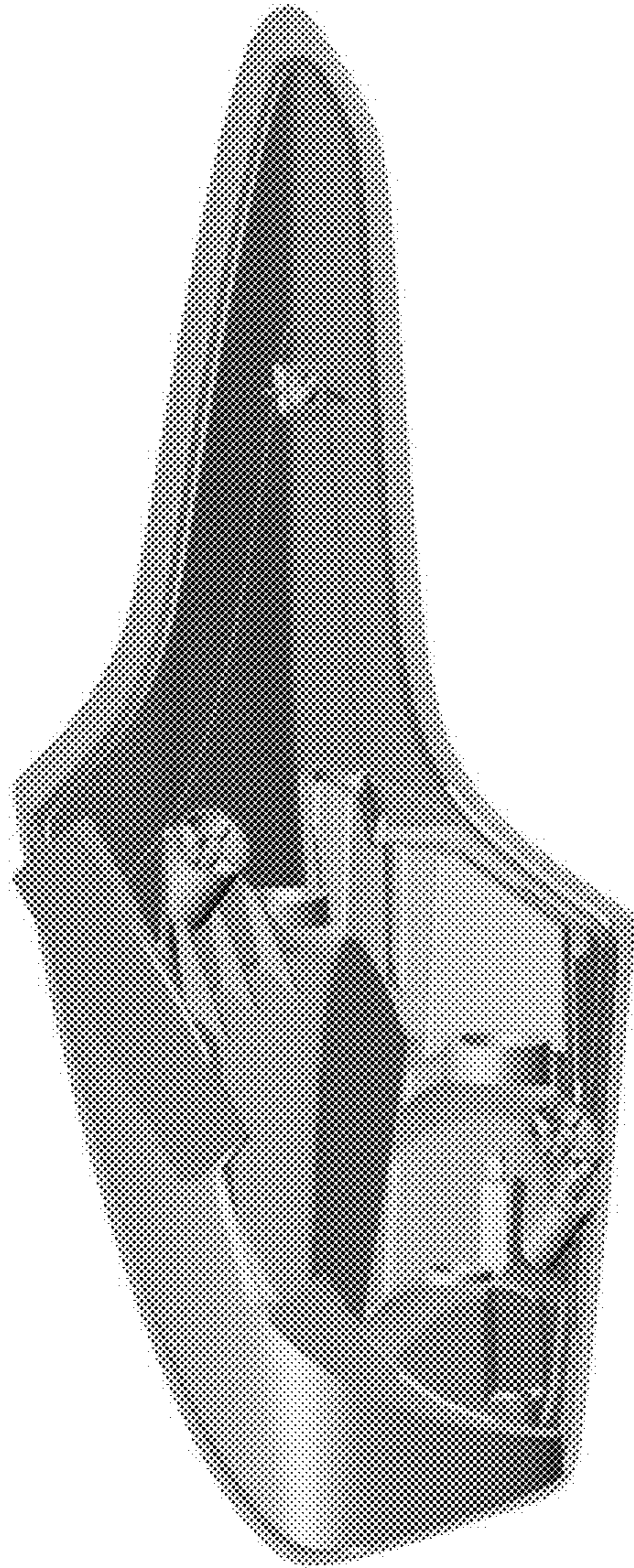

Figure 5

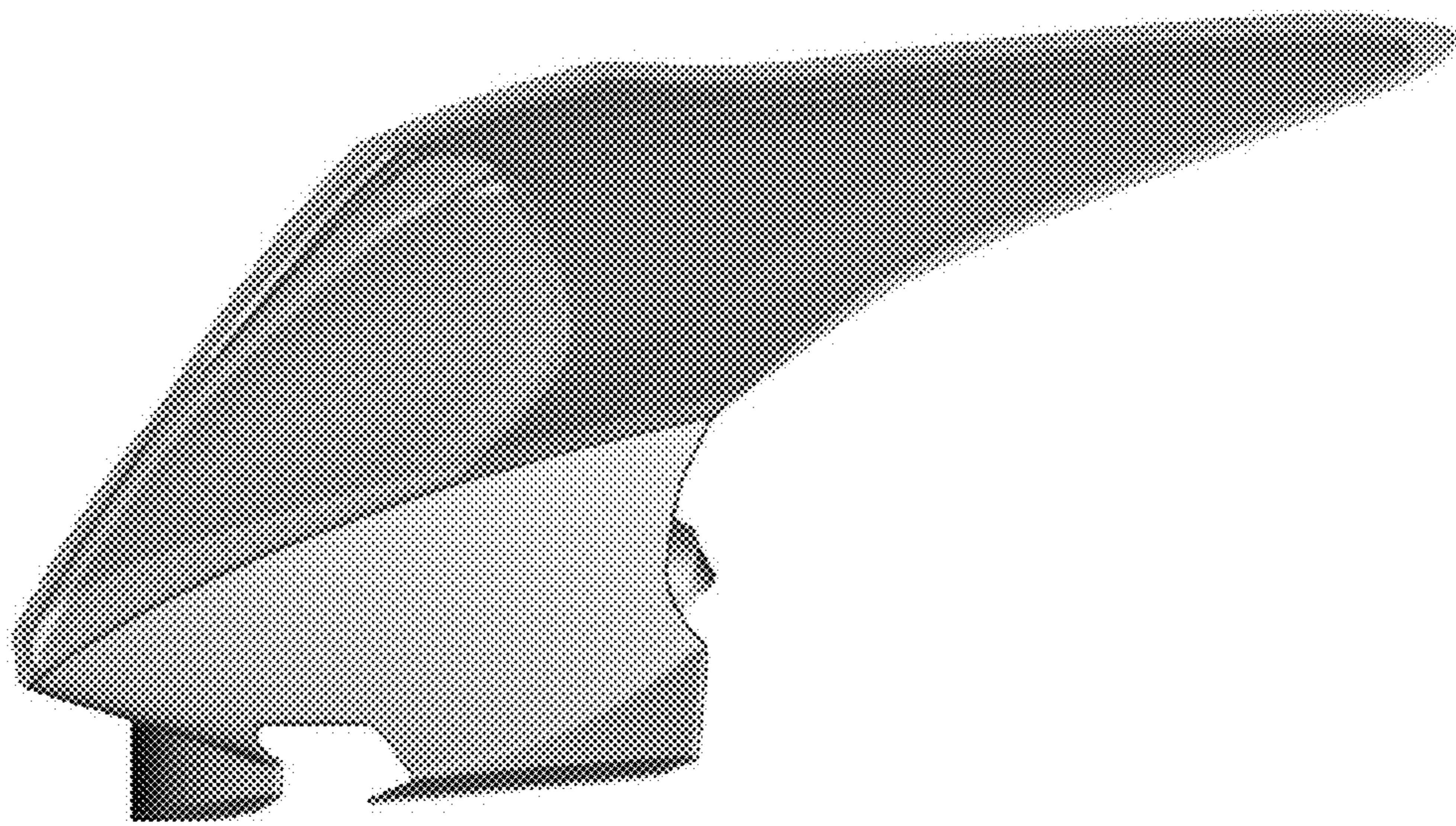

FIGURE 6

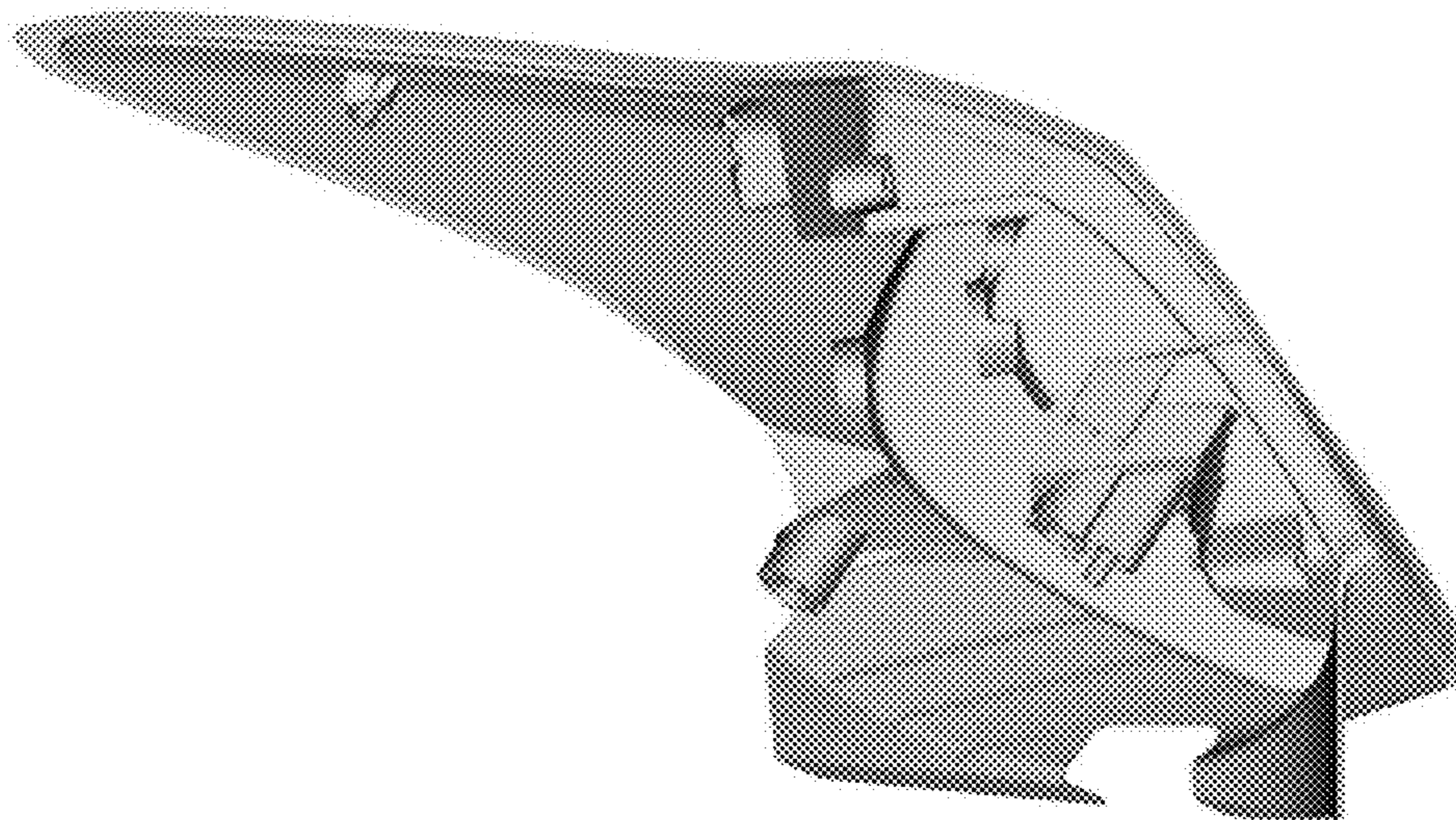

FIGURE 7