



US00D750157S

(12) **United States Design Patent**
Ahn et al.

(10) **Patent No.:** **US D750,157 S**
(45) **Date of Patent:** **** Feb. 23, 2016**

(54) **STAMP**
(71) Applicant: **Samsung Electronics Co., Ltd.**,
Suwon-si, Gyeonggi-do (KR)
(72) Inventors: **Hyo-In Ahn**, Seoul (KR); **Eun-Kyung Yoo**, Seoul (KR); **Ji-Su Jung**, Yongin-si (KR); **Dong-Goo Kang**, Seoul (KR); **Say Jang**, Yonginsu (KR)

6,634,288 B1 * 10/2003 Imamaki B41K 1/02
101/125
D506,775 S * 6/2005 Kida D18/15
6,935,231 B2 * 8/2005 Naritomi B41K 1/10
101/103
D585,932 S * 2/2009 Kida D18/15
D614,688 S * 4/2010 Wilflingseder D18/15
D620,973 S * 8/2010 Fukasawa D18/15
7,765,924 B2 * 8/2010 Suda B41K 1/10
101/111
D679,317 S * 4/2013 Ono D18/15

(73) Assignee: **SAMSUNG ELECTRONICS CO., LTD.** (KR)

FOREIGN PATENT DOCUMENTS

(**) Term: **14 Years**
(21) Appl. No.: **29/482,214**
(22) Filed: **Feb. 14, 2014**

CN 3465718 * 8/2005
CN 302081811 * 9/2012
CN 3269912 * 12/2012
GB 2040895 * 12/1994
JP D1181638 * 8/2003
JP D1200252 * 3/2004
KR 300414571.0000 * 5/2006

(30) **Foreign Application Priority Data**
Oct. 24, 2013 (KR) 30-2013-0053544

* cited by examiner

(51) **LOC (10) Cl.** **19-02**
(52) **U.S. Cl.**
USPC **D18/15**
(58) **Field of Classification Search**
USPC D18/15, 16, 17, 18, 50; D19/65-68, 70,
D19/71; 101/104, 333, 334, 327, 328, 405,
101/406; 118/264, 268; D9/521, 544, 545
CPC B41K 1/00; B41K 1/006; B41K 1/02;
B41K 1/08; B41K 1/40; B41K 1/42; B41K
1/52; B41K 1/54; B41K 1/56
See application file for complete search history.

Primary Examiner — Bridget L Eland
Assistant Examiner — Lauren McVey
(74) *Attorney, Agent, or Firm* — Cantor Colburn LLP

(56) **References Cited**

(57) **CLAIM**
We claim, the ornamental design for a stamp, as shown and described.

U.S. PATENT DOCUMENTS

DESCRIPTION

D247,261 S * 2/1978 Hormann D18/15
D280,643 S * 9/1985 Ichikawa D18/15
D280,644 S * 9/1985 Ichikawa D18/15
4,996,921 A * 3/1991 Hong B41K 1/52
101/327
D399,245 S * 10/1998 Harden D18/14

FIG. 1 is a perspective view of a stamp, showing our new design;
FIG. 2 is a front elevation view thereof;
FIG. 3 is a rear elevation view thereof;
FIG. 4 is a side elevation view thereof;
FIG. 5 is a another side elevation view thereof;
FIG. 6 is a top plan view thereof; and,
FIG. 7 is a bottom plan view thereof.
The broken lines illustrating portions of the stamp are for environmental purposes only and form no part of the claimed design.

1 Claim, 4 Drawing Sheets

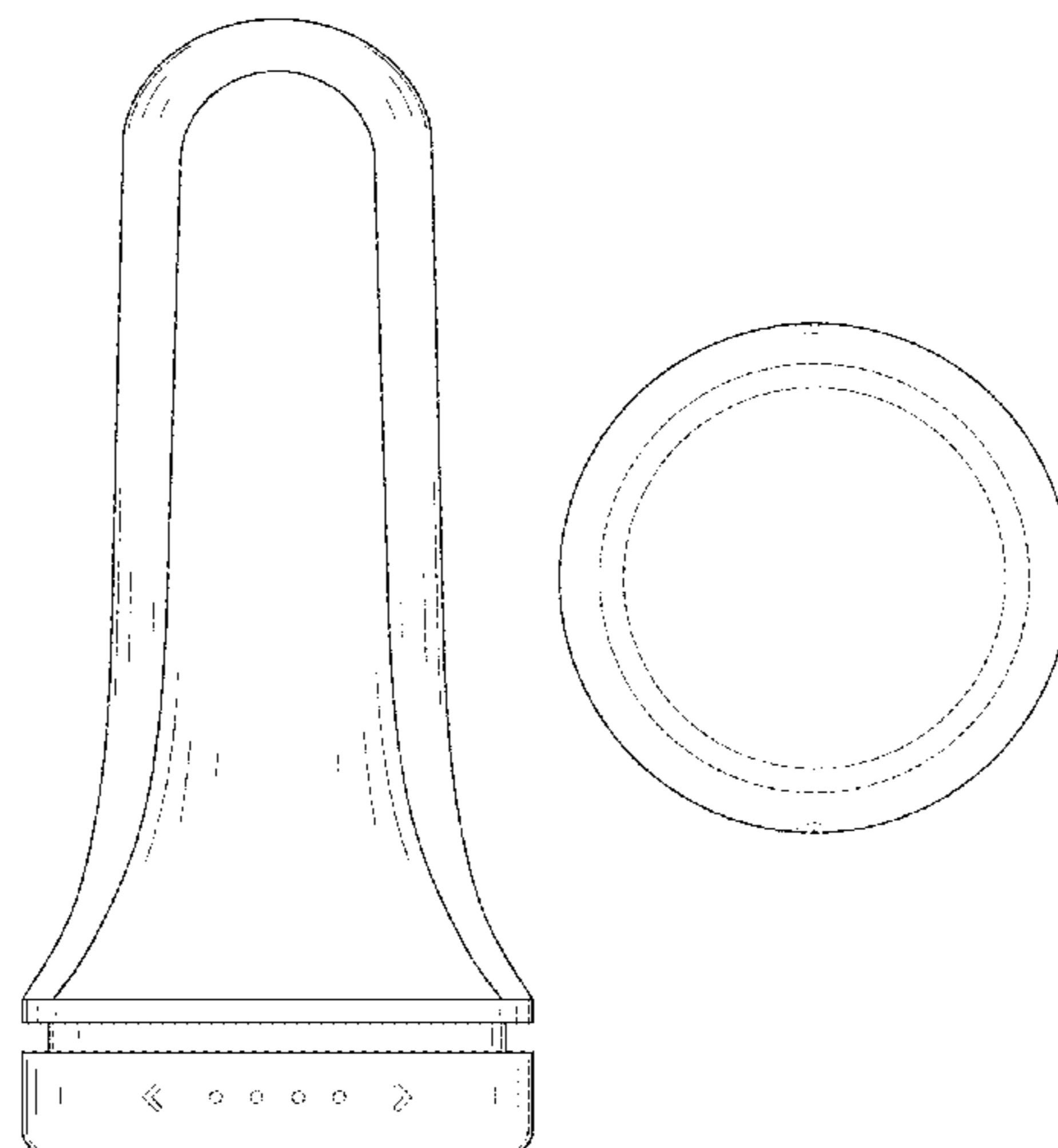

FIG. 1

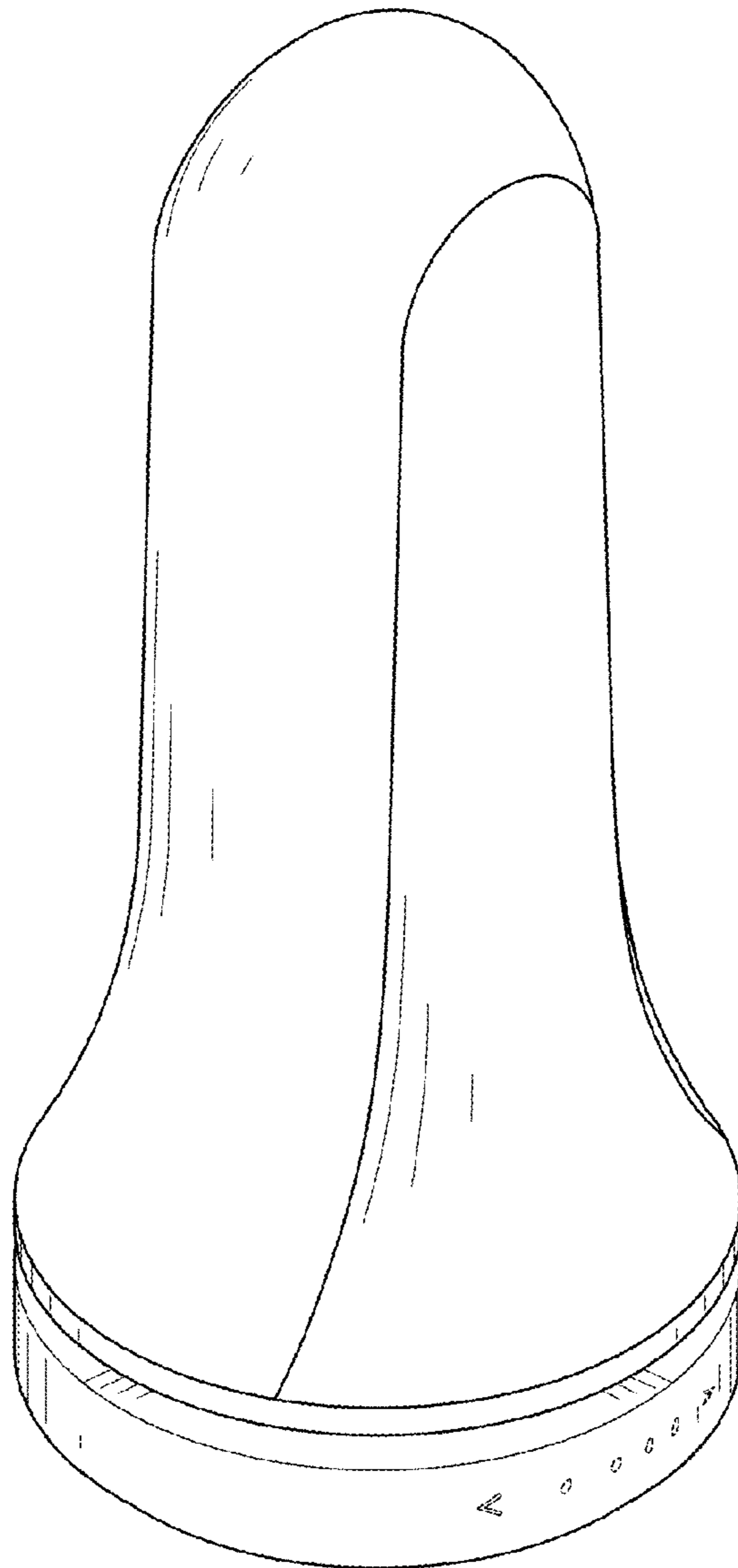

FIG.2

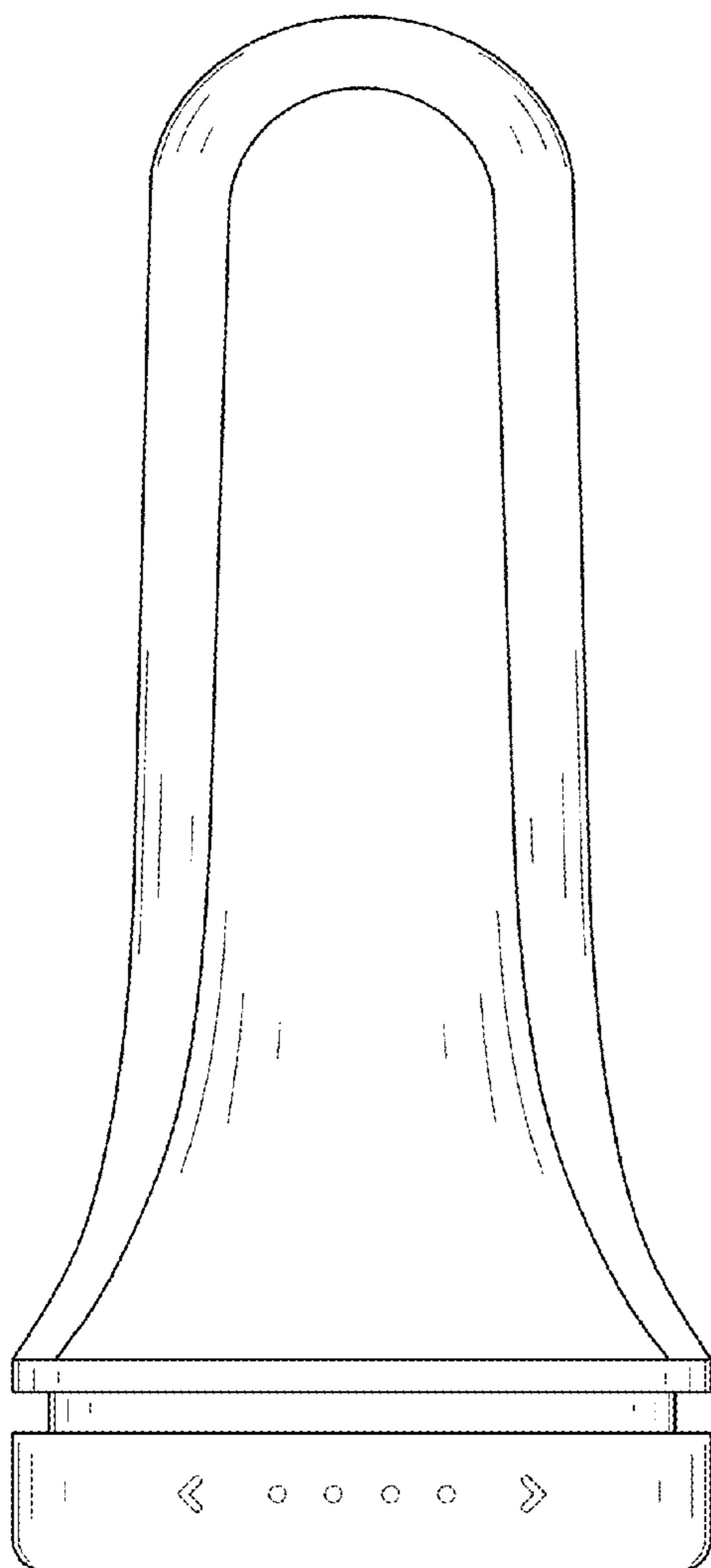

FIG.3

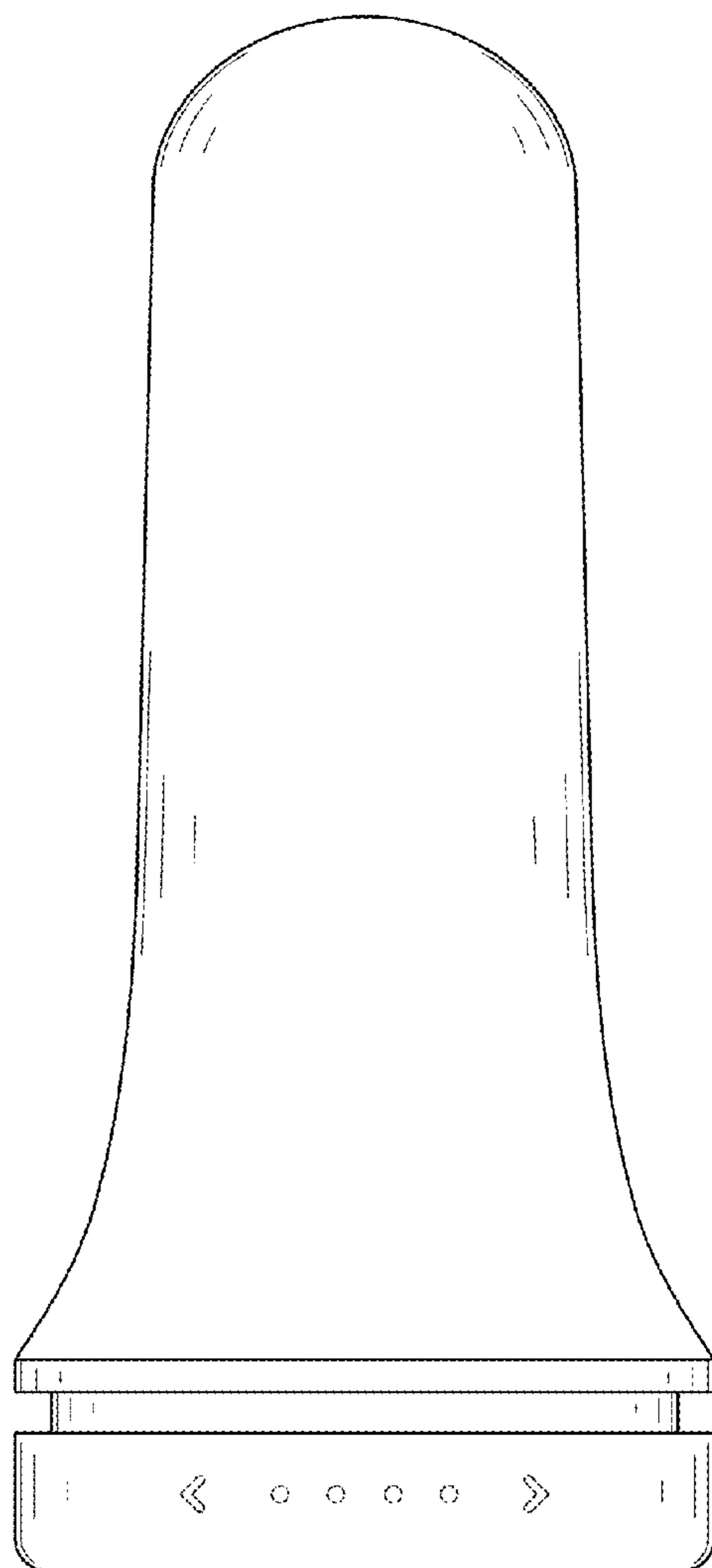

FIG.4

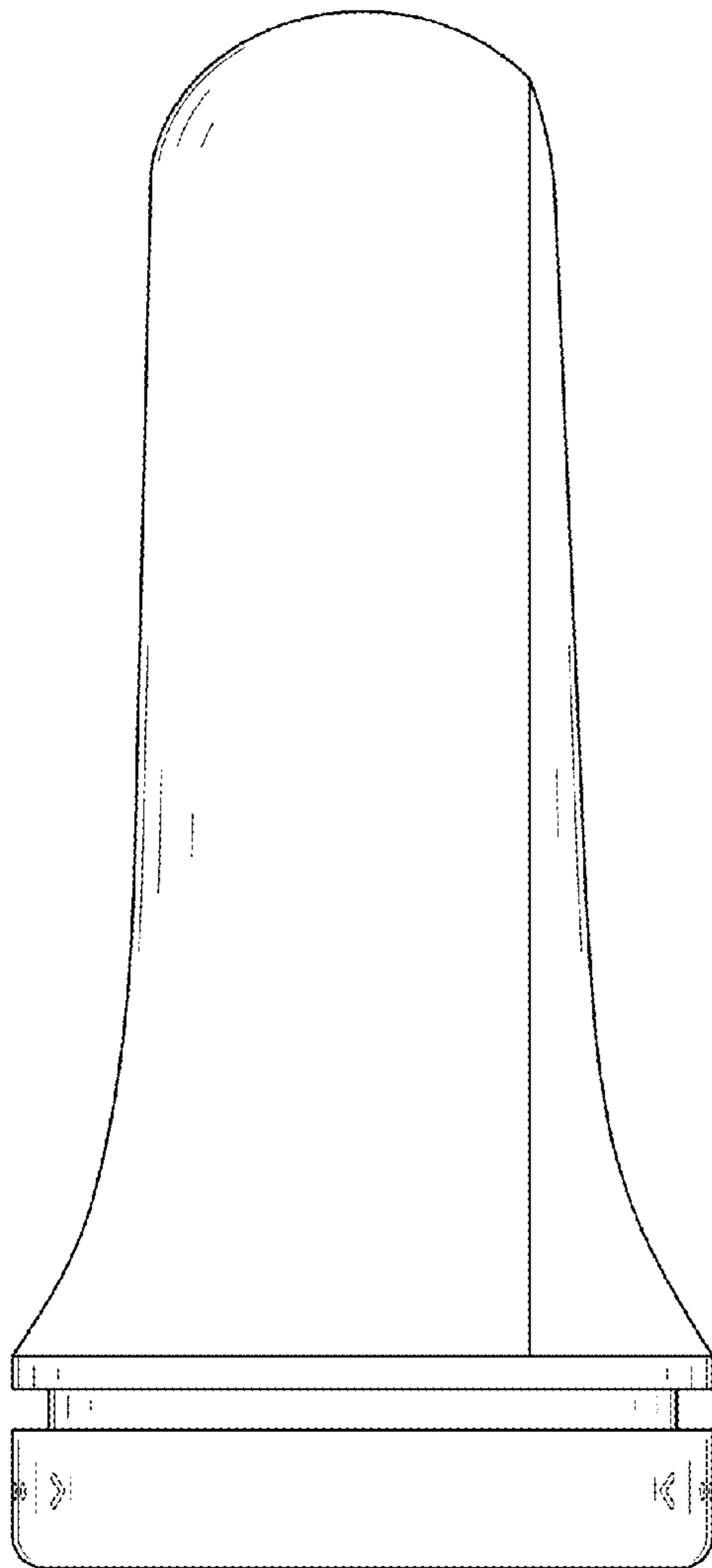

FIG.5

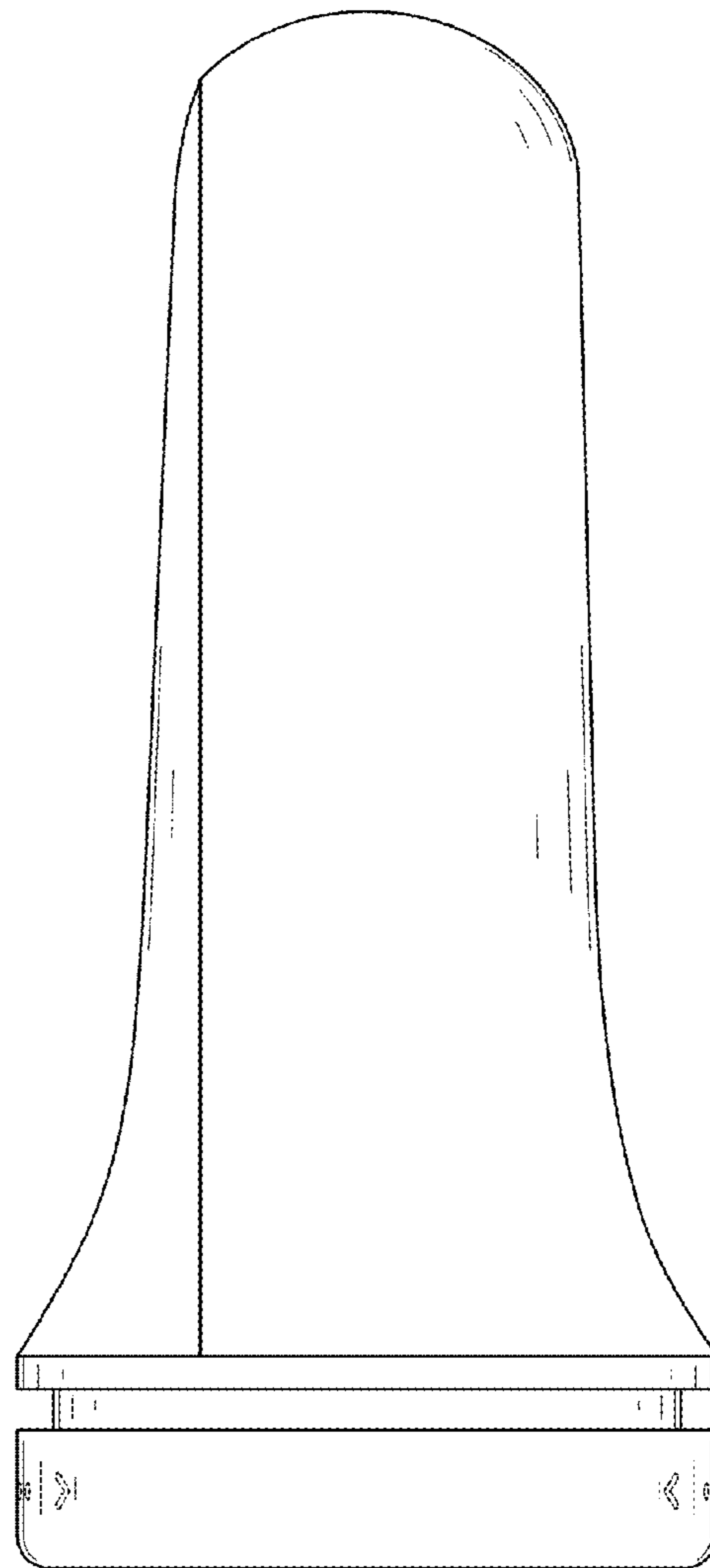

FIG. 6

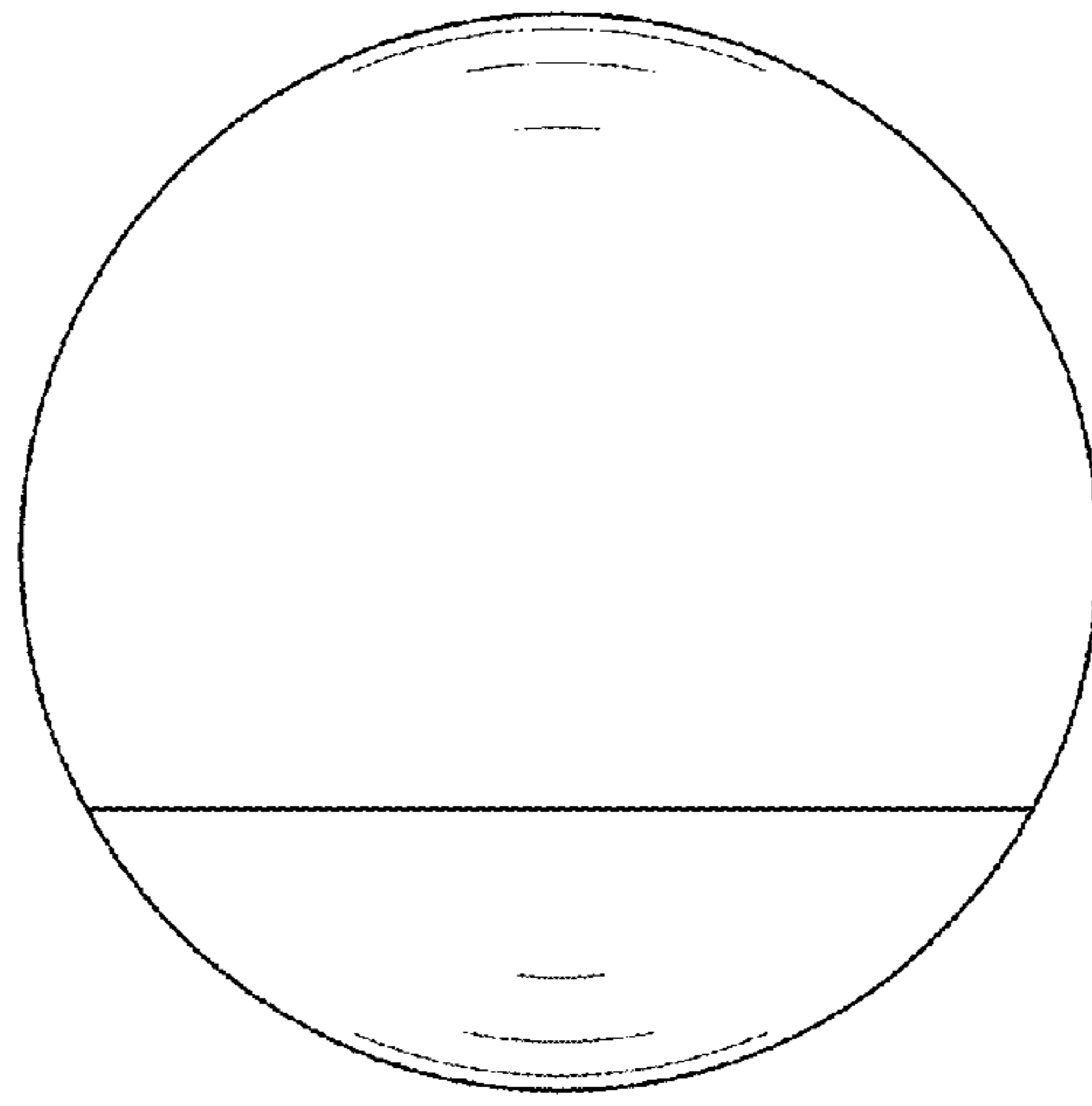

FIG. 7

